

IPNext180PTT

NGN PTT Hybrid IP-PBX System

High-performance Next Generation PTT Hybrid IP-PBX System

Preliminary Product Overview



AddPac

AddPac Technology

Sales and Marketing

www.addpac.com

Contents

- Product Overview
- Hardware Specification
- Software Service
- IP-PBX Service and Features
- RTP Proxy Service
- User Presence Service
- Network Service and Features
- PTT & RoIP Service
- User Terminals
- Application Area
- Ordering Information

Product Overview

IPNext180 PTT Hybrid IP-PBX System

- IP based Advanced Hybrid IP-PBX Solution
- High Performance PTT Server Solution
- IPv4/IPv6 Multimedia Telephony Solution for Small & Medium Office
- PSTN Interface (FXO, FXS) Support
- Powerful Management and User Friendly Features
- Fault Tolerant and Scalability Architecture
- High-performance Video, Audio, and Voice Service
- Firmware Upgradeable Architecture
- IVR Service with Scenario Editor
- Voice Mailing Service
- Presence Service for High-End IP Key Phone, UC
- RTP Proxy Service for Private IP service
- SIP, H.323 Signaling for Outbound Calls
- Various Call Scenario (Call Pickup, Call Park, Call Transfer, etc)
- Various IP Terminal Support

Product Highlights

IPNext180 PTT Hybrid IP-PBX System

IP based Advanced PTT Hybrid IP-PBX System

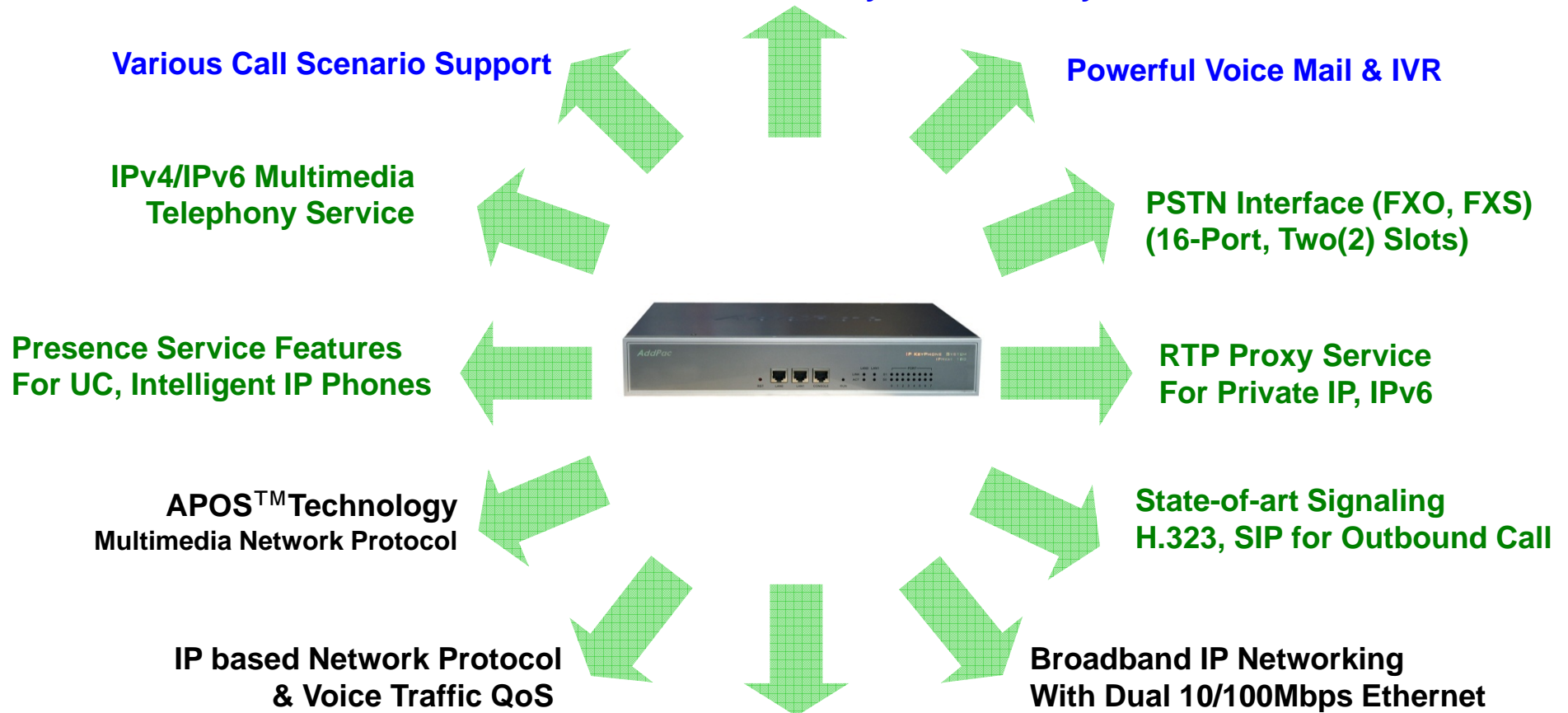

Smart Multimedia Manager for System Management

www.addpac.com

AddPac

Hardware Specification

IPNext180 PTT Hybrid IP-PBX System

64bit
CPU

- **RISC Microprocessor Computing Power**
- **Main Chassis**
 - **Fixed Network Interface**
 - Two(2) 10/100Mbps Fast Ethernet
 - One(1) RS-232C Console (RJ45)
 - **Two(2) VoIP Module Slots for FXS, FXO etc**



Hardware Specification

IPNext180 PTT Hybrid IP-PBX System

64bit
CPU

DSP

Front Side



LAN1 (10/100Mbps)

LAN0(10/100Mbps)

Console Port

Hardware Specification

IPNext180 PTT Hybrid IP-PBX System

64bit
CPU

DSP

Back Side

PSTN Interface Module



Power Inlet

Power Switch



Hot-Swap Switch & LAMP Indication





Hardware Specification

IPNext180 PTT Hybrid IP-PBX System

64bit
CPU

Audio
Codec

- **VoIP Interface Module**

AP-N1-FXS8	 A black 8-port FXS voice processing module with RJ11 ports and a handset jack.	8-Port FXS Voice Processing Module (8 x RJ11)
AP-N1-FXO8	 A black 8-port FXO voice processing module with RJ11 ports and a handset jack.	8-Port FXO Voice Processing Module (8 x RJ11)
AP-N1-FXO4S4	 A black 8-port voice processing module with 4 FXO and 4 FXS ports.	4-Port FXO and 4-Port FXS Voice Processing Module (8 x RJ11)
AP-N1-E1T1	 A black 1-port VoIP digital E1/T1 interface module with an RJ45 port and a handset jack.	1-Port VoIP Digital E1/T1 Interface Module(1xRJ45)

Software Service

IPNext180 PTT Hybrid IP-PBX System

- **Built-in AddPac APOS Internetworking Software**

- Scalability, Functionality, and Stability Features
- Advanced Call Manager Features
- Media Gateway Features
- QoS Control Features

- **Programmable Video, Audio, and Voice Services**

- Audio, and Voice Codec

- **Firmware Upgradeable Architecture**

- **Industry Standard Network Protocol Features**

- **Highly User Friendly Management Features**

- Smart Messenger for UC
- Smart Multimedia Manager

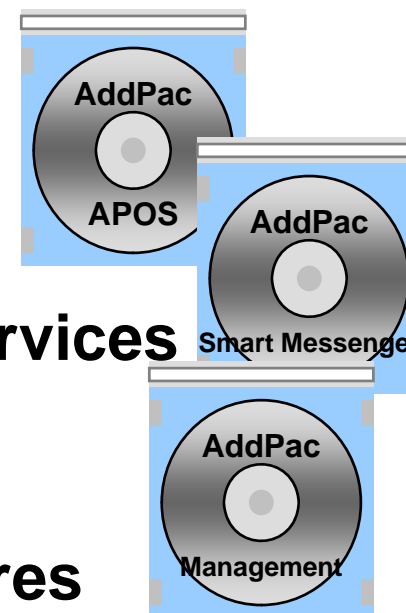

IP-PBX Software Components

IPNext180 PTT Hybrid IP-PBX System

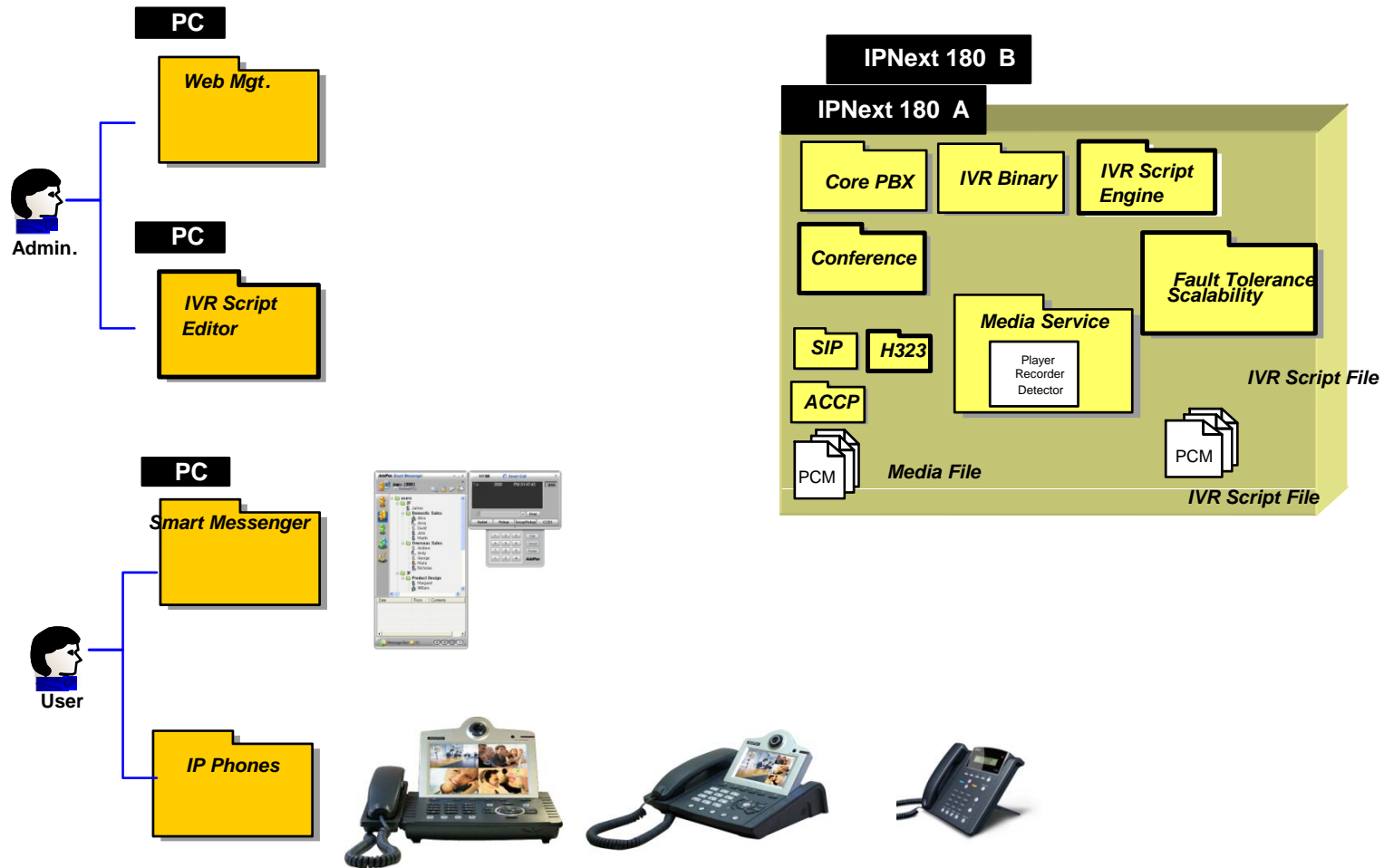

IP Telephony Service and Features

IPNext180 PTT Hybrid IP-PBX System

- **Signaling Server**

- SIP Application Server, Proxy, Registrar and Location Server (RFC3261)
- Multiple ITSP Trunk with SIP & H.323 Accounts Support
 - IP UA Client Role for Registering to ITSP SIP Server
 - H.323 Gatekeeper Client Role for Registering to ITSP H.323 Gatekeeper Server

- **IVR & Auto Attendant**

- Default Auto Attendant Support
- Interactive Voice Response (IVR)
 - Provides with GUI-based Smart IVR Scenario Editor
 - Upload/Download Scenario by Smart IVR Scenario Editor
 - Supports Multiple Concurrent Scenarios
 - Supports Recordable IVR Prompts

- **Voice Mail**

- Support Voice Mail with IVR
- Access from Remote Site via Trunk Support
- Voice Mail Notification Support

IP Telephony Service and Features

IPNext180 PTT Hybrid IP-PBX System

- **Number & Call Routing**

- Trunk Hunting by Preference or Sequential
- Call Hunting by Preference, Simultaneous, Random
- Call Hunting by Chained Hunting Group
- Partition for Address Grading
- Call Class for Call Access Control
- Number Translation Rule for Inbound/Outbound Call
- Centrex with Prefix Support
- Multiple Shared Devices with One Number
- Multiple Numbers on One Device
- Individual Call Park within Park Number Pool
- Group Call Park within a Group or Other Group
- Call Pickup of Ringing Call of Same Group or Other Group
- Call Pickup of Parked Call
- Call Transfer - Blind, Consult
- Call Forwarding - Unconditional, Busy, No Answer, Voice Mail
- Call Waiting
- Call Swaping
- Call Hold

IP Telephony Service and Features

IPNext180 PTT Hybrid IP-PBX System

- **IP-PBX Advanced Features with AddPac IP Phones**

- Multiple Call Handling with Call Status and Calling Line Number and Name
- Plug and Play with Auto Discovery Function
- Softkey Map Download and Control
- Time and Date Setting
- Voice Mail List View
- Parked Call List View
- Call Forward Setting
- Recent Call List View
- Calling Number and Name Identification
- Individual Call Park within Park Number Pool by Softkey
- Group Call Park within a Group or Other Group by Softkey
- Call Pickup of Ringing Call of Same Group or Other Group by Softkey
- Call Pickup of Parked Call by Softkey
- Call Transfer - Blind, Consult by Softkey
- Call Waiting Indication
- Call Swaping by Softkey
- Call Hold by SoftKey
- Conference Control

IP Telephony Service and Features

IPNext180 PTT Hybrid IP-PBX System

- **User & Device Management**

- LDAP (Light weight Directory Access Protocol) Support
 - Supports Hierarchical Organization
- Auto Discovery of IP Phones & Video Phones
- Monitoring Status of Phones

- **Miscellaneous***

- Distinctive Ring by Calling User
- Auto Config & Upgrade
- Personal Directory
- Downloadable Ring
- Do not Disturb

IP Telephony Service and Features

IPNext180 PTT Hybrid IP-PBX System

- **Conference**

- G.711 (4-party Conference, 2 session) : Basic
- G.711/G.729/G.723 (4-party Conference, 2session) Internal MCU Module : Option
- Ad-hoc Conference
- Dial-Out Conference
- Meet-me Conference
- Multiple External MCU support(Video, Audio, etc) : AddPac AP-MC1000, etc
- Conference Chair and Participants Management

- **Music & Announcement**

- Music on Hold
- Replaceable Announcements
- Dialing Music / Tone Service

SIP based Basic Call Scenario

IPNext180 PTT Hybrid IP-PBX System

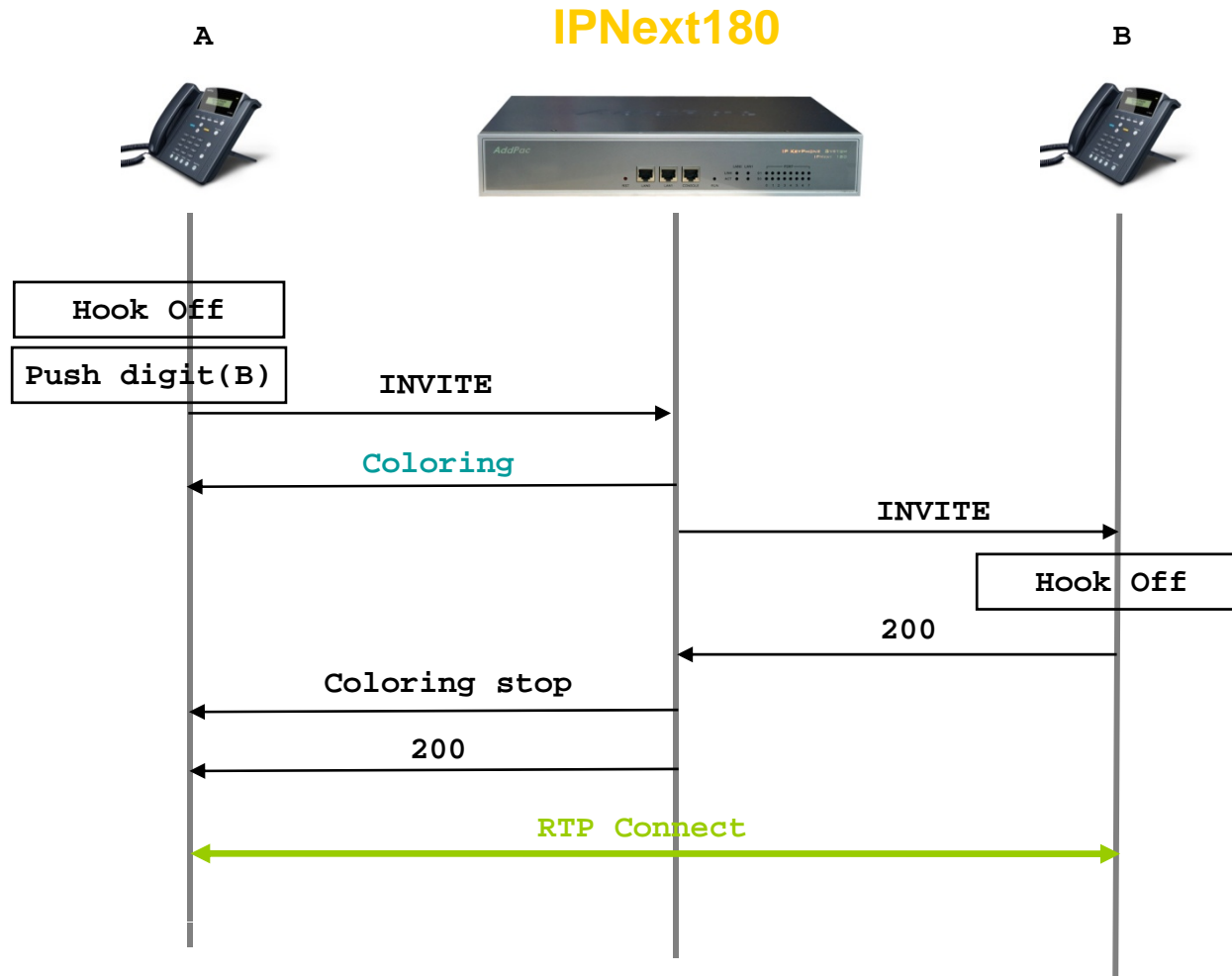

RTP Proxy Service

IPNext180 PTT Hybrid IP-PBX System

Public/Private RTP Proxy
without NAT Router

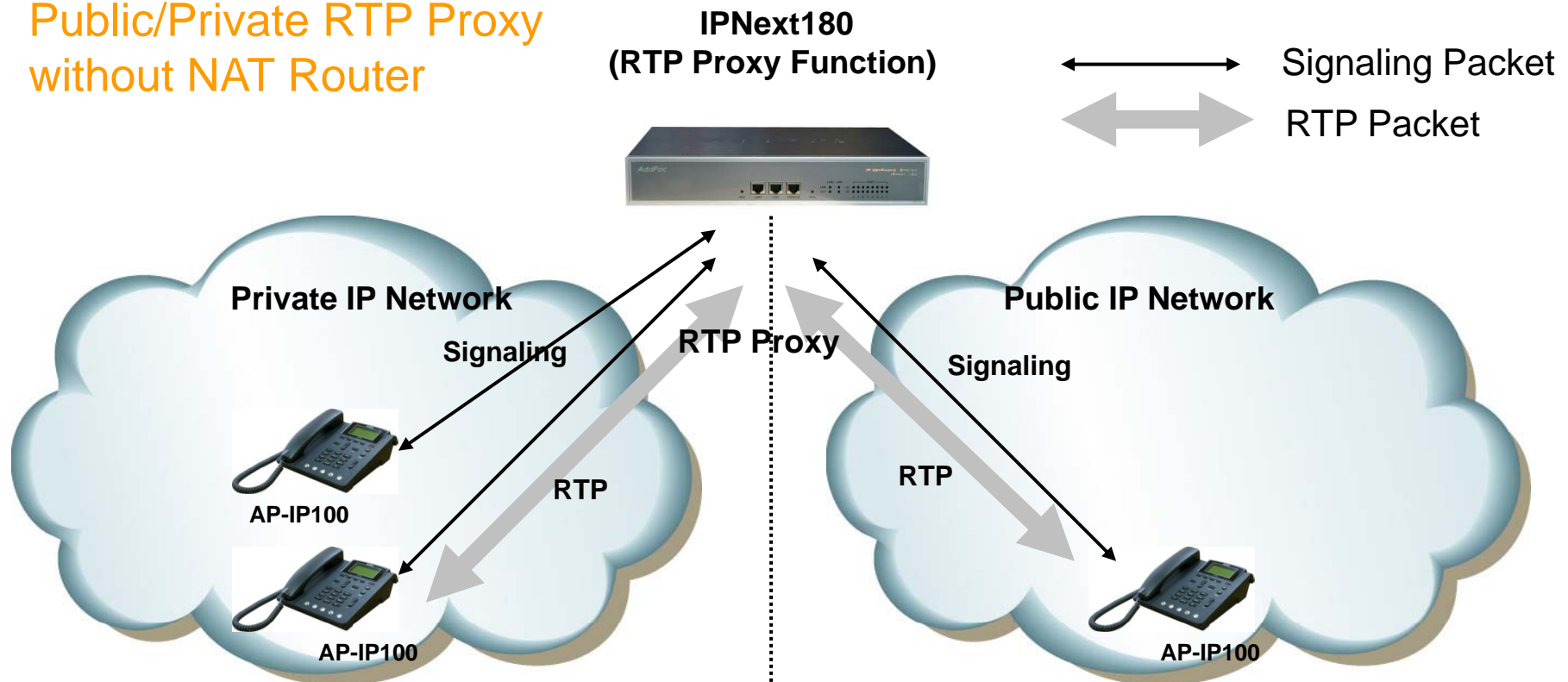

- Located between public and private network
- IPNext180(Call manager + RTP proxy) has public and private address
- IPNext180 determine that the call is internal or external

RTP Proxy Service

IPNext180 PTT Hybrid IP-PBX System

Asymmetric/Symmetric NAT

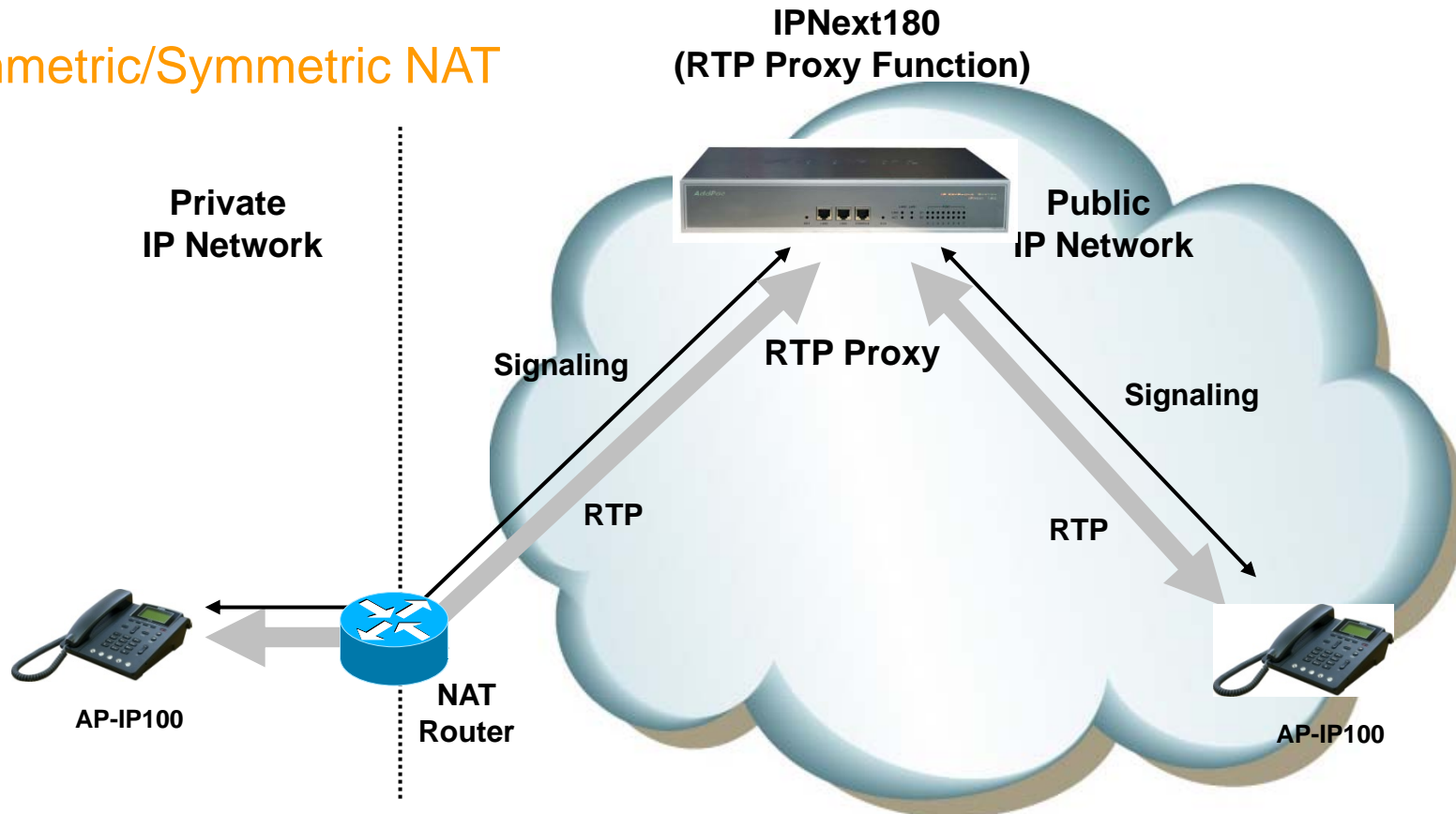

- Located in public network
- RTP Proxy has single public address
- Auto detect for asymmetric NAT via incoming RTP packet

RTP Proxy Service

IPNext180 PTT Hybrid IP-PBX System

RTP Proxy Communication between Private IP

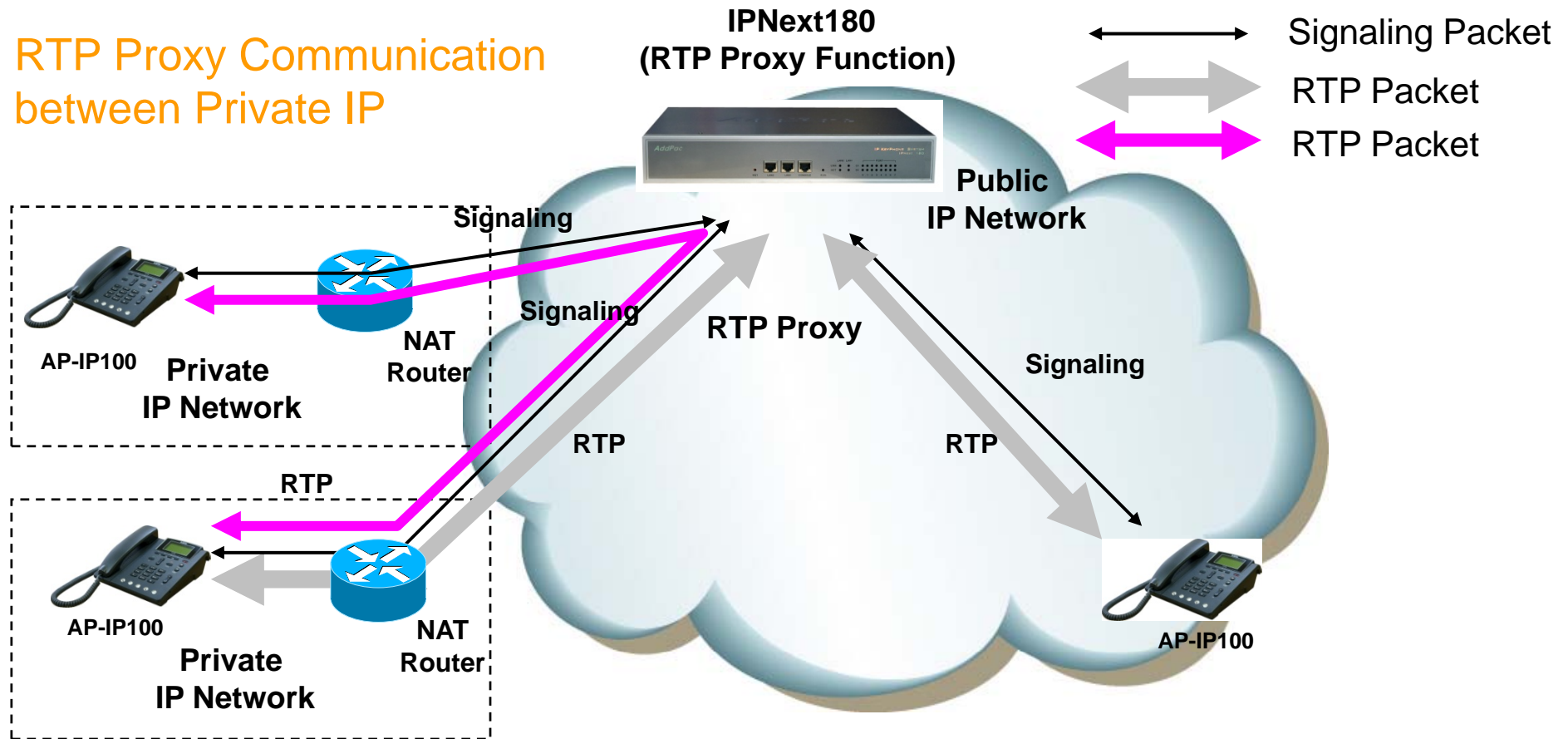

- Located in public network
- RTP Proxy has single public address
- Auto detect for asymmetric NAT via incoming RTP packet

RTP Proxy Service

IPNext180 PTT Hybrid IP-PBX System

IPv4/IPv6 RTP Proxy

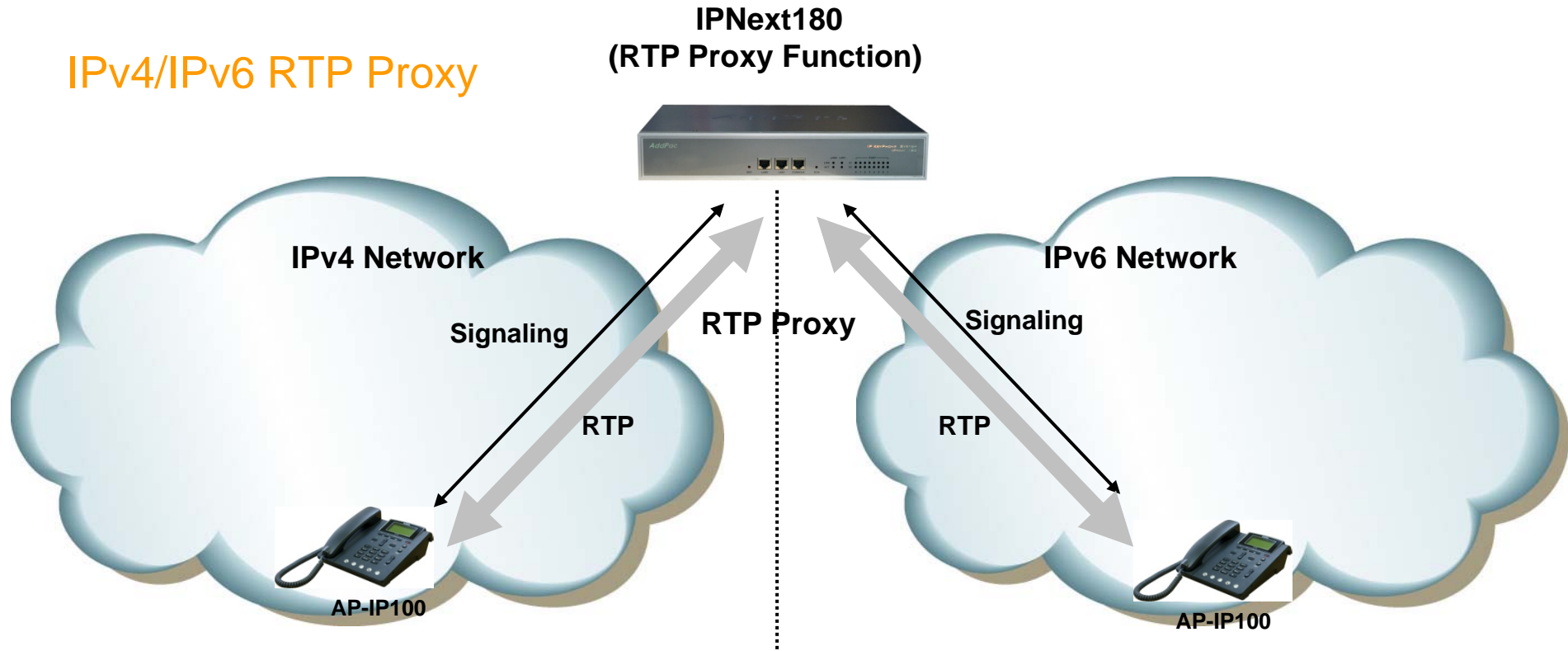

- IPNext180(Call manager + RTP proxy) has IPv4 and IPv6 address

User Presence Service for UC

IPNext180 PTT Hybrid IP-PBX System

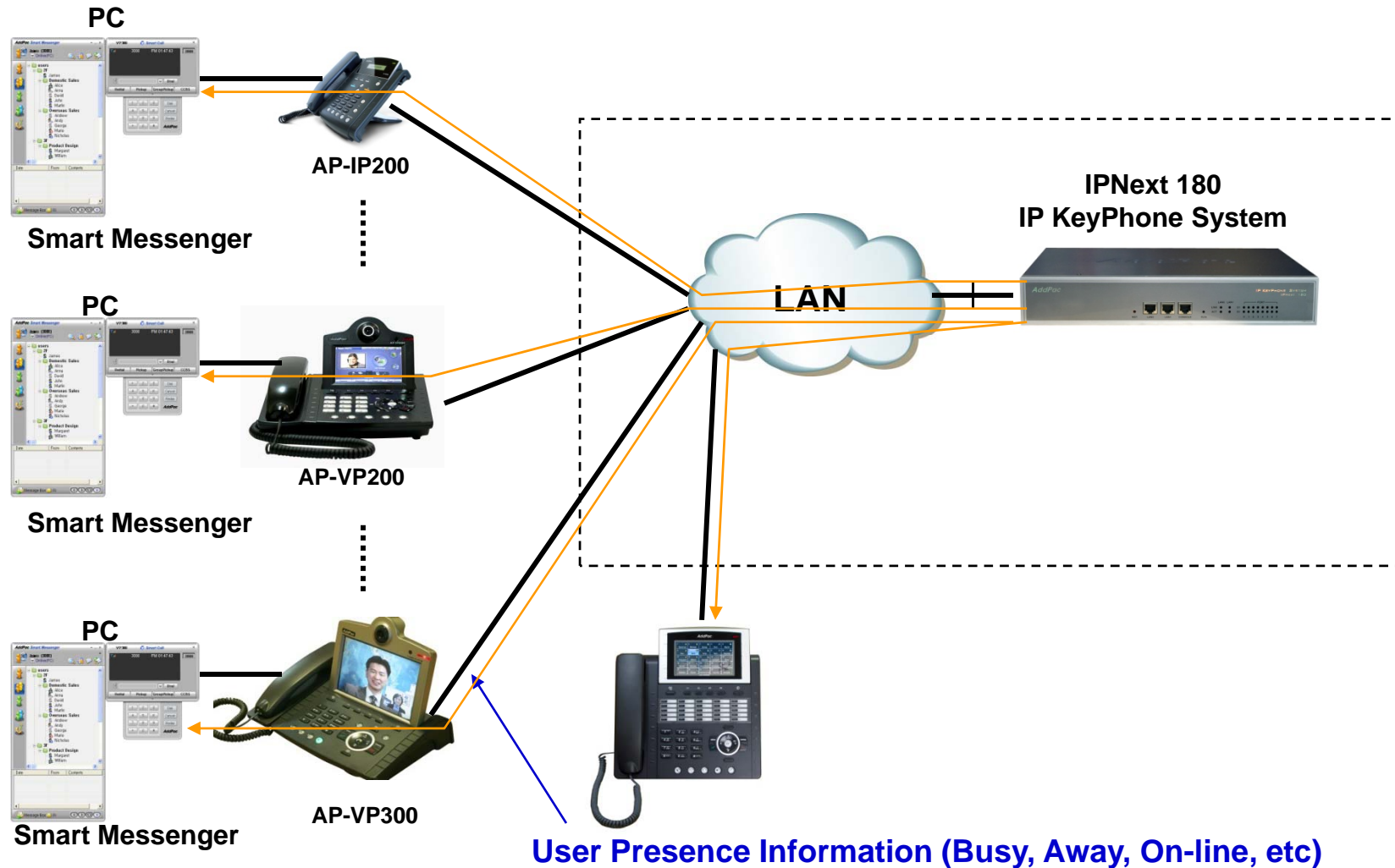

Network Service and Features

IPNext180 PTT Hybrid IP-PBX System

Basic Network Protocols

- ARP, IP, IPv6, TCP, UDP, ICMP, ICMPv6, SCTP, IGMP, MLD

Routing Protocol

- IPv4 : Static
- IPv6 : Static

Service Protocol

- FTP, Telnet, TFTP, DHCP Server/Relay, SNMP Server
- CDP (Cisco Discovery Protocol)
- DNS Resolver , DDNS(nsupdate)
- Bridge
- Syslog
- IP/IPv6 policy control (QoS)
- VPDN (Virtual Private Dial-up Network : L2TP Server)

Network Service and Features

IPNext180 PTT Hybrid IP-PBX System

IPv4/IPv6 Interworking

- NAT/PAT for IPv4
- IP connect (formerly ip-share) and device cascade for IPv4
- IP/IP, IP/GRE tunneling
- NAT-PT
- 6to4, Autoconfig tunneling

IPv4 Address Configuration

- Fixed (Static)
- DHCP
- PPPoE

IPv6 Address Configuration

- Fixed (Static)
- EUI-64
- Autoconfig (Neighbor Advertisement and Solicitation)

Network Service and Features

IPNext180 PTT Hybrid IP-PBX System

Miscellaneous

- Cisco Style CLI
- Standard & Extended IPv4/IPv6 Access List
- Multi-level User Account Management
- IP accounting
- fsh (Embedded file system shell)
- STUN Client

Network Service and Features

IPNext180 PTT Hybrid IP-PBX System

SNMP MIBs

- MIB-II
- RMON MIBs (Statistics, History, Alarm, Hosts Group)
- RFC2465 Management Information Base for IP Version 6: Textual Conventions and General Group
- RFC2466 Management Information Base for IP Version 6: ICMPv6 Group
- RFC2452 IP Version 6 Management Information Base for the Transmission Control Protocol
- RFC2454 IP Version 6 Management Information Base for the User Datagram Protocol
- AddPac Enterprise MIBs
- etc

PTT Service

IPNext180 PTT Hybrid IP-PBX System

- IP based PTT Service Support
- Dial-Out based PTT Service Support
 - Multi-Session, Multi-Group
 - PtP (Point-to-Point) Service
- Advanced PTT Server Features
 - 1:1 PTT
 - Group PTT
 - Emergency PTT with Alarm Notification
- Emergency PTT Service Support
- IP-PBX Interworking Service
- IP Terminal Interworking Service (Wi-Fi Phone, IP Phones, Soft Phone, Smart Phone Application)
- PTT Solution with Outstanding Network Service Capability

RoIP System Message Flow



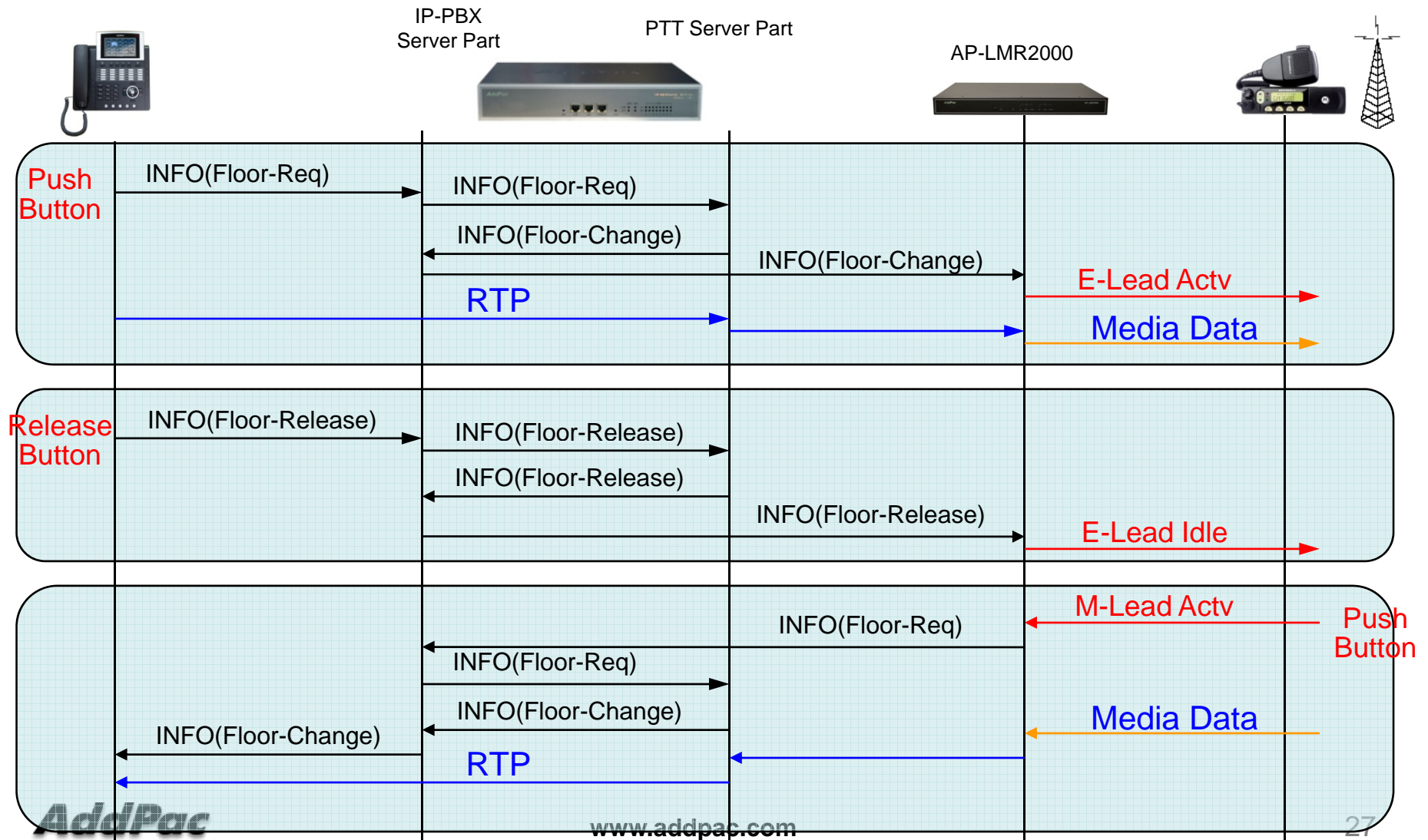

(IP-PBX + PTT Server Integrated Server Model)

SIP Message Flow (Floor Control : Push To Talk)



AddPac IP Phone Comparison Table

IPNext180 PTT Hybrid IP-PBX System

	AP-IP300	AP-IP250	AP-IP230	AP-IP160	AP-IP120	AP-IP90
						
LCD Size	4.3 Inch Color LCD	4.3 Inch Color LCD	5 Inch Color LCD	4 Text Line Graphic LCD	4 Text Line Graphic LCD	4 Text Line Graphic LCD
Touch Screen	N/A	Support	Support	N/A	N/A	N/A
Speed-Dial Keys	25 Key with Presence LED	Touch Screen based 25 Keys	Touch Screen based 25 Keys	16 Key with Presence LED	12 Key with Presence LED	N/A
Voice Codec	G.711/G.726/ G.729/G.723	G.711/G.726/ G.729/G.723	G.711/G.726/ G.729/G.723	G.711/G.726/ G.729/G.723	G.711/G.726/ G.729/G.723	G.711/G.726/ G.729/G.723
Signaling	H.323/SIP	H.323/SIP	H.323/SIP	H.323/SIP	H.323/SIP	H.323/SIP
3-Party Conversation	Support	Support	Support	Support	Support	Support
LAN Port	2	2	2	2	2	2
PoE(Optional)	Support	Support	Support	Support	Support	Support
FXO(Optional)	Support	Support	Support	Support	Support	Support

Standard PTT IP-PBX System Application

IPNext180 PTT IP-PBX System

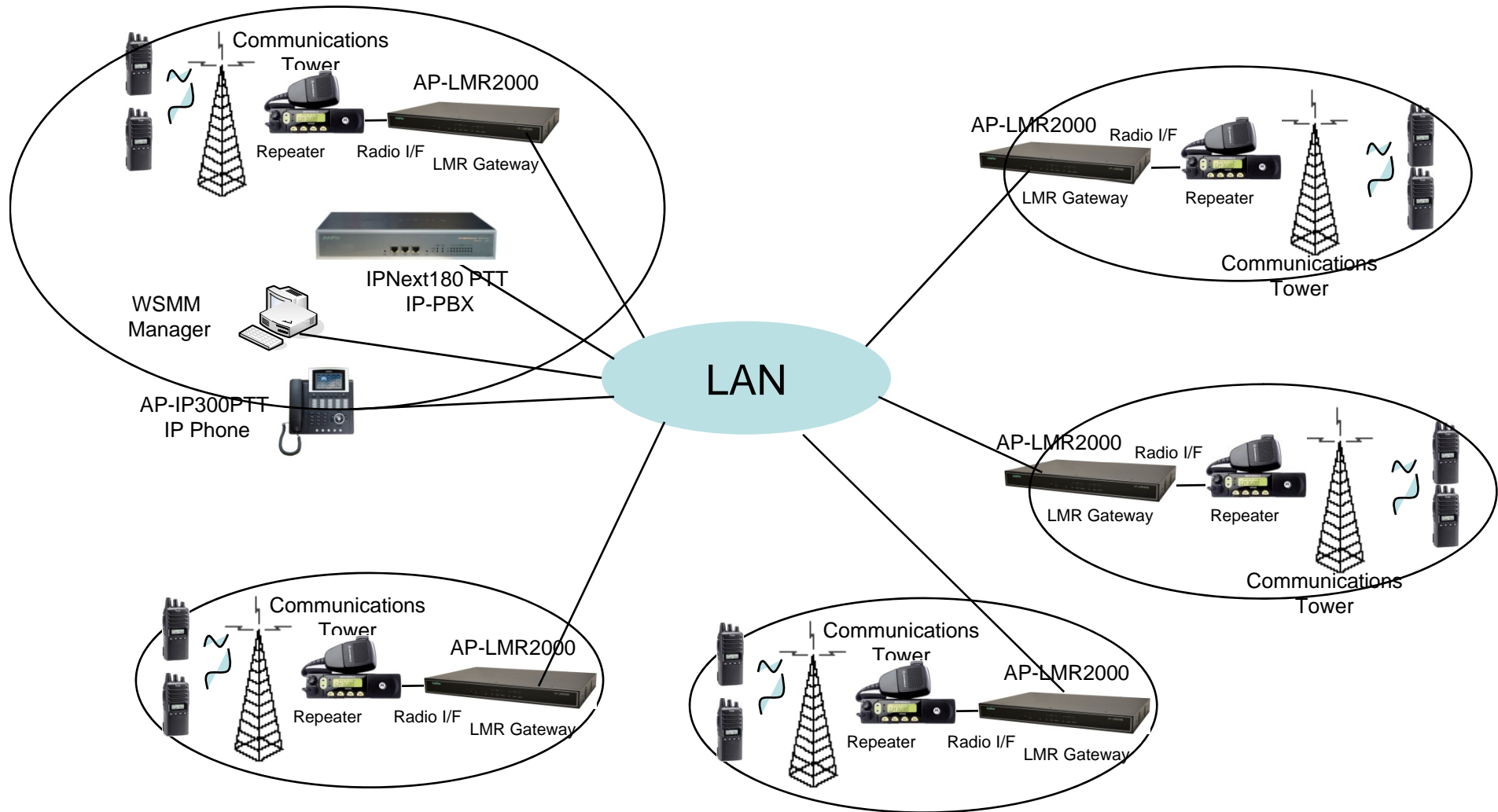

Ordering Information

- **IPNext180 PTT Hybrid IP-PBX System**
 - IPNext180 PTT IP-PBX System Main Body
 - High-performance RISC CPU
 - 2-ports 10/100Mbps Fast Ethernet and 1-port RS-232C Console
 - Internal Power Supply
 - Including Network Cable Set & Power Supply Cable, etc.
 - PSTN Interface Modules (Option)
- **Built-in APOS Internetworking Software for IPNext180 PTT**
- **Including 1 Year Hardware Warranty**
- **Product Documents**
 - Install and Operation Guide (PDF)
- **Pricing**
 - AddPac Technology Regional Sales Manager
 - Authorized Sales and Marketing Representatives
 - Please Contact www.addpac.com



Thank you!

AddPac Technology Co., Ltd.
Sales and Marketing

Phone +82.2.568.3848 (KOREA)

FAX +82.2.568.3847 (KOREA)

E-mail sales@addpac.com