



AP5850

Multiservice Router

High Performance Multiservice Router Solution



AddPac

AddPac Technology

2015, Sales and Marketing

www.addpac.com

Contents

AP5850 Multiservice Router

- Product Overview
- Hardware Specification
- ATM Service Features
- WAN Service Features
- Video Service Features
- Network Service and Features
- Application Area
- Ordering Information

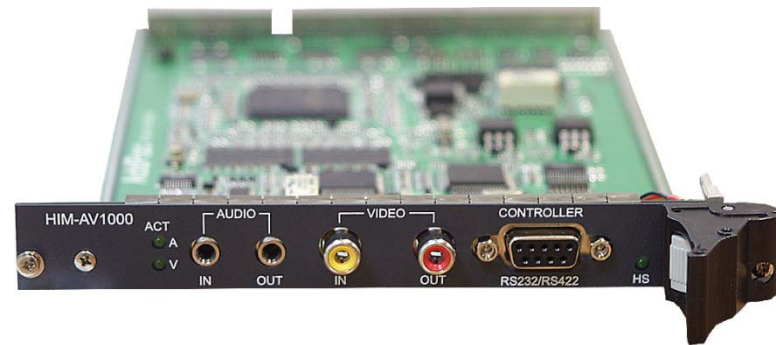

Product Overview

AP5850 Multiservice Router

- High Performance Multiservice Router Solution
- Support ATM, POS, LAN, Serial Interface
- Compact PCI Style Hot-Swap Module
- Scalability and Flexibility
- High-performance Video, Audio, and Data Service
- Firmware Upgradeable Architecture
- Dual Power Supply for Redundancy
- Video Solution with Outstanding Network Service Capability

Product Highlights

AP5850 Multiservice Router

High-End Multiservice Router Solution

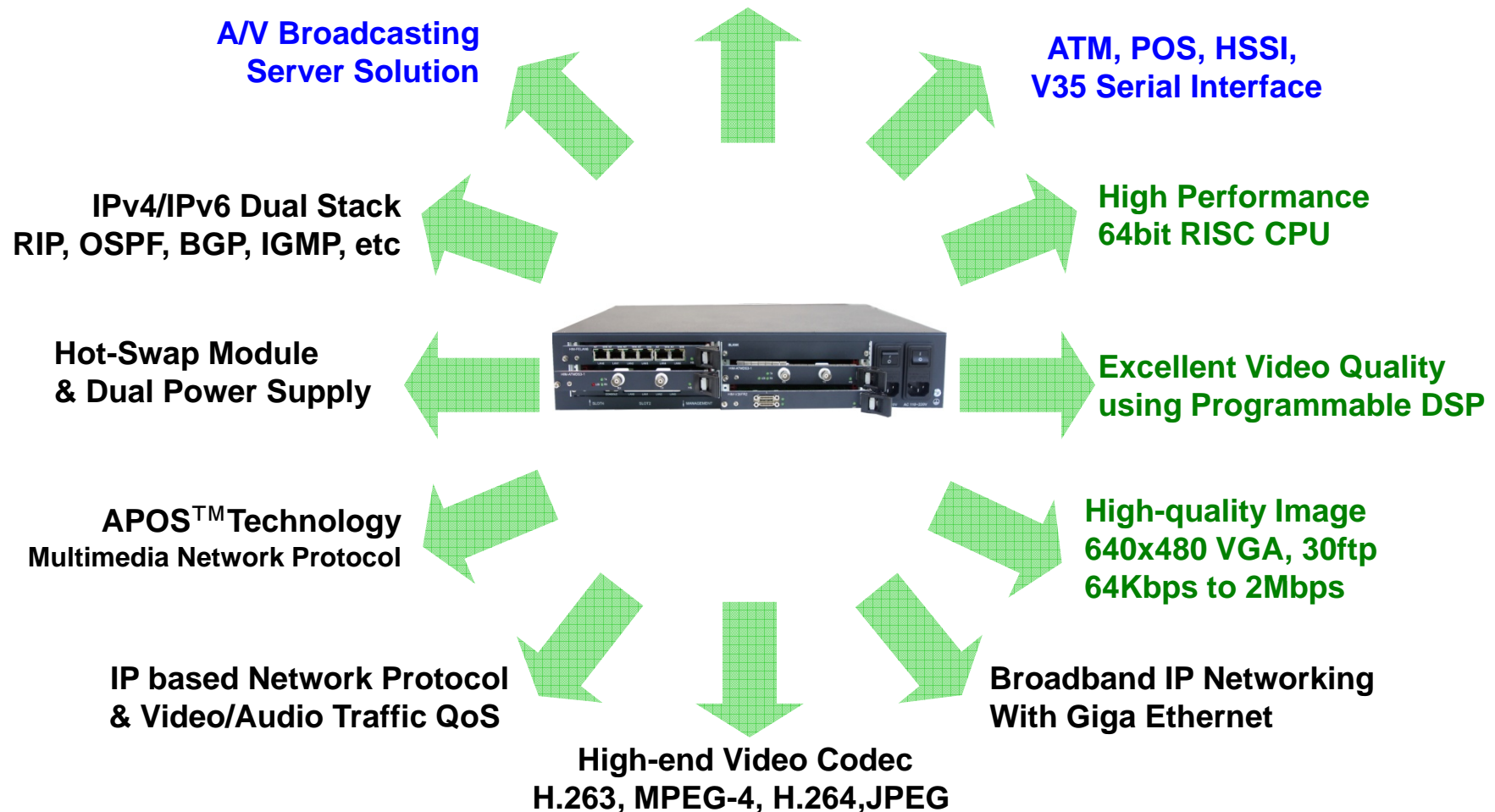

Multimedia Service

AP5850 Multiservice Router

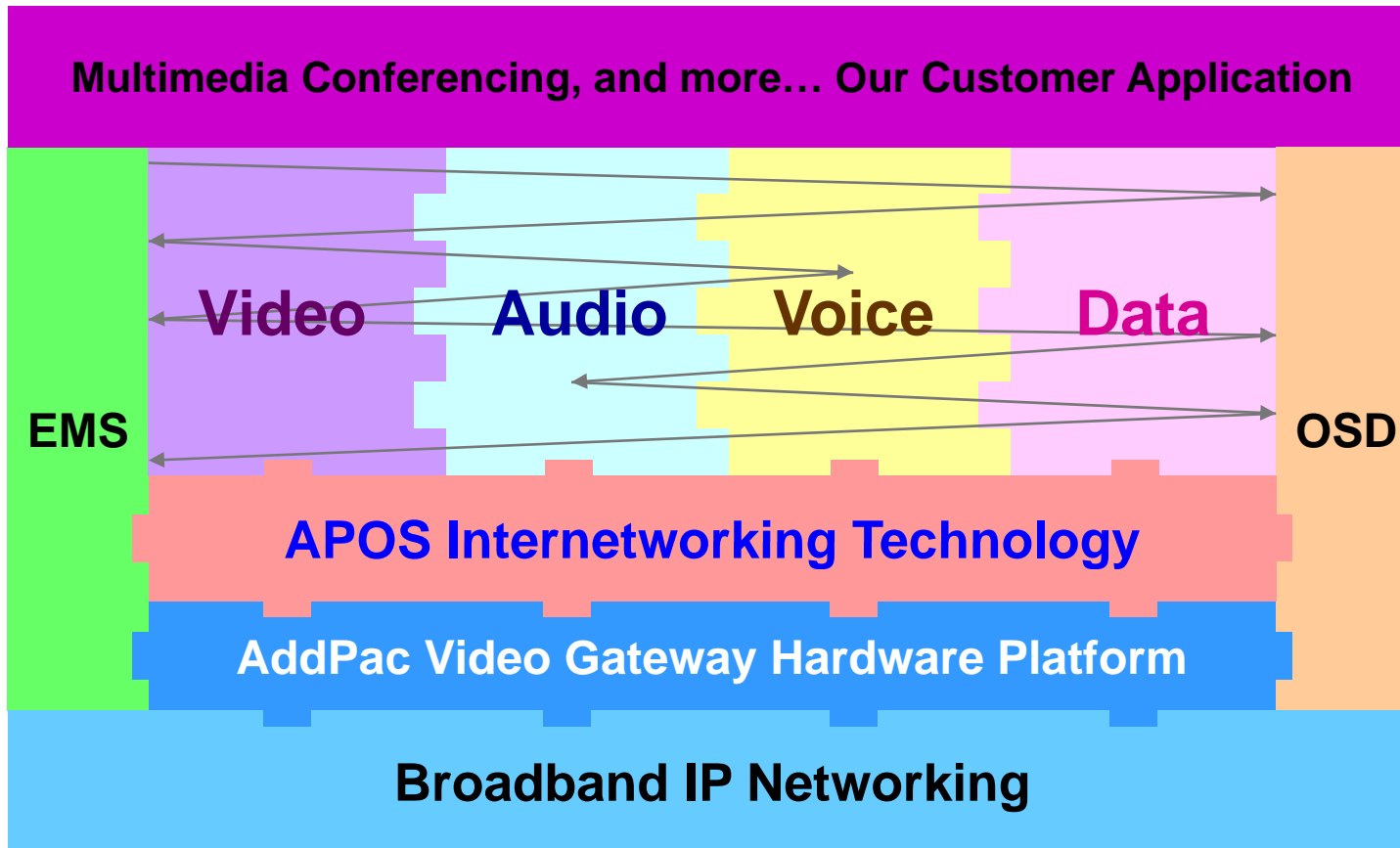

- APOS : AddPac Internetworking Operating System
- OSD : On- Screen Display
- EMS : Element Management System

APOS Internetworking Protocol Stack

AP5850 Multiservice Router

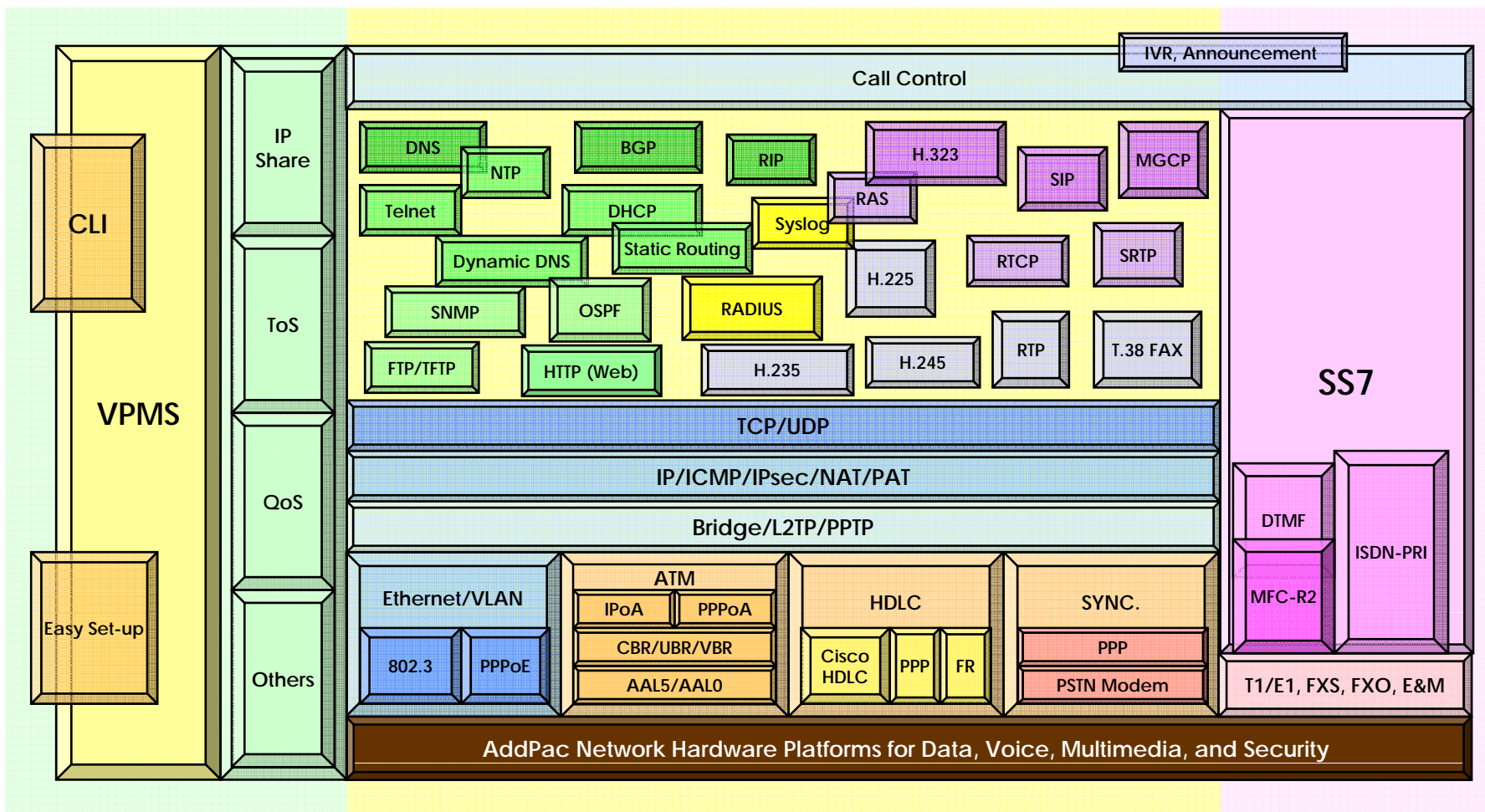

Hardware Specification

AP5850 Multiservice Router

64bit
CPU

High-end
DSP

- High Performance RISC Microprocessor Computing Power
- Main Chassis
 - Network Interface
 - Four(4) 10/100Mbps Fast Ethernet
 - One(1) RS-232C Console (RJ45)
 - Five(5) Multiservice Interface Module Slots
 - Dual Power Supply for Redundancy



AddPac

www.addpac.com

Hardware Specification

AP5850 Multiservice Router

64bit
CPU

High-end
DSP

- **HIM-AV1000 Module**

- High quality Audio and Video Codec
- Compact PCI Style Hot-Swap Function
- Active LEDs
- High-End Programmable DSPs
- Concurrent Different Video/Audio Codec Support
- RS232/RS422 DB-9 Interface for External Camera Control
- H.263, MPEG4, H.264, JPEG, MP3, etc

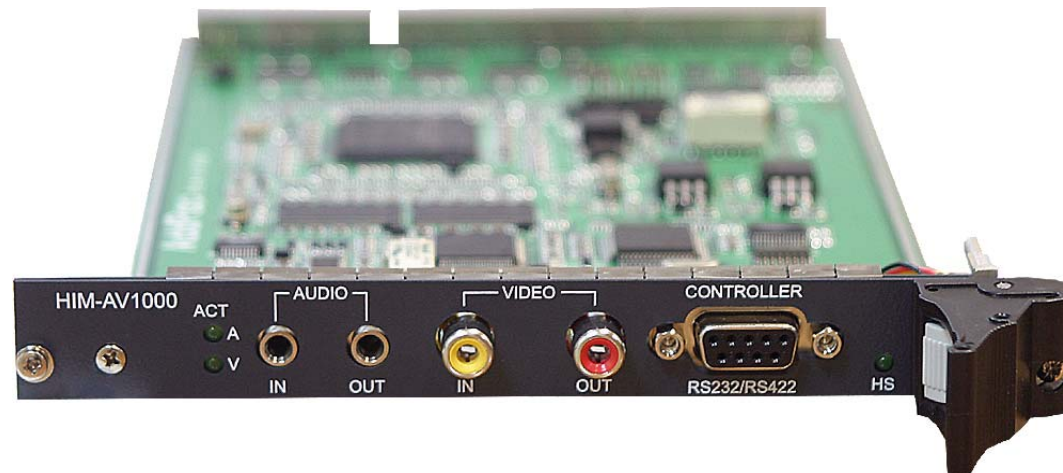

Hardware Specification

AP5850 Multiservice Router

64bit
CPU

- **HIM-HDD1000 Module**
 - 2.5 Inch IDE HDD
 - PCI based Hard Disk Controller
 - Compact PCI Style Hot-Swap Function
 - RAID1 Configuration for Fault Management (Dual HDD)
 - USB 2.0 Interface Support
 - PC File System Support







Hardware Specification

AP5850 Multiservice Router

64bit
CPU

- **WAN Interface Module**

HIM-ATMOC3-1		1-Port OC3 155Mbps ATM Network Interface Module
HIM-ATMDS3-1		1-Port DS3 45Mbps ATM Network Interface Module
HIM-V35FR2		2-Port V.35 Interface Module
HIM-V35FR6		6-Port V.35 Interface Module
HIM-GE1		1-Port Gigabit Ethernet Module
HIM-FELAN6		6-Port Fast Ethernet Module

ATM Service and Features

AP5850 Multiservice Router

- ATM PVC UNI3.0, 3.1, 4.0 Support
- RFC1483 and RFC1577 based IPoA Service
- PPPoA Services
- IPoA Service
- ATM Classes of Service Support
 - ATM PVCs and SVCs Service
 - CBR, rt-VBR, nrt-VBR, UBR, and UBR+ Support
 - AAL0 ,AAL5
- PCR and MCR Service
- ATM Traffic Management Support
- VBR Type 1 and Type2 Support
- Provide Priority Level of 8-layer with ATM Pace Control
- Traffic shaping on a per-VC basis

WAN Service and Features

AP5850 Multiservice Router

- Point-to-Point Protocol(PPP) Support
- PPPoE Support
- Frame-Relay PVC with Inverse ARP Support
- High-level Data Link Control (HDLC) Protocol Support
- HDLC Encapsulation Support (Interoperability with CISCO HDLC)

Video Service and Features

AP5850 Multiservice Router

- Various Video Networking Interface
 - Composite (RCA), S-Video
- High-performance Video Codec Support
 - H.263, MPEG-4, JPEG, and H.264
- Powerful Image Resolution Support
 - QCIF(176x144), CIF(352x288), QVGA(320x240), and VGA(640x480)
- Up to 30fps at 1Mbps with VGA-Resolution(MPEG-4)
- 64Kbps to 4Mbps Operating Video Traffic Bandwidth
- High-end Error Resilient Against Various Packet Error

Network Service and Features

AP5850 Multiservice Router

- **Network Managements**
 - Standard SNMP Agent (MIB v2) Support
 - Remote Management using Console, Telnet
 - Web based Management using HTTP Server Interface
- **Security Functions**
 - Standard & Extended IP Access List
 - Enable/Disable for Specific Network Protocols
 - Multi-level User Account Management
 - Auto-disconnect for Telnet/Console Sessions
 - PPP User Authentication Supports (PAP & CHAP)
- **Operation & Managements**
 - System Performance Analysis for Process, CPU, Connection Interface
 - Debugging, System Auditing, and Diagnostics Support
 - System Booting and Auto-rebooting with Watchdog Feature
 - System Managements with Data Logging
 - IP Traffic Statistics with Accounting

Network Service and Features

AP5850 Multiservice Router

- **Network Managements**
 - DHCP Server & Relay Functions
 - Network Address Translation (NAT) Function
 - Port Address Translation (PAT) Function
 - Transparent Bridging (IEEE Standard) Function
 - Spanning Tree Bridging Protocol Support
 - Remote Bridging Support
 - Concurrent Routing and Bridging Support
 - Cisco Style Command Line Interface (CLI)
 - Network time Protocol (NTP) Support

AP5850 Multiservice Router

Application Area

- Audio/Video Real-time Broadcasting
- Media Encoder for VoD Application
- ATM Router Application
- Multi-Channel V.35 Serial Interface Router

Audio/Video Real-time Broadcasting

AP5850 Multiservice Router

Audio and Video Broadcasting Service via Multicasting IP Network (Video, Audio/Voice, and more...)

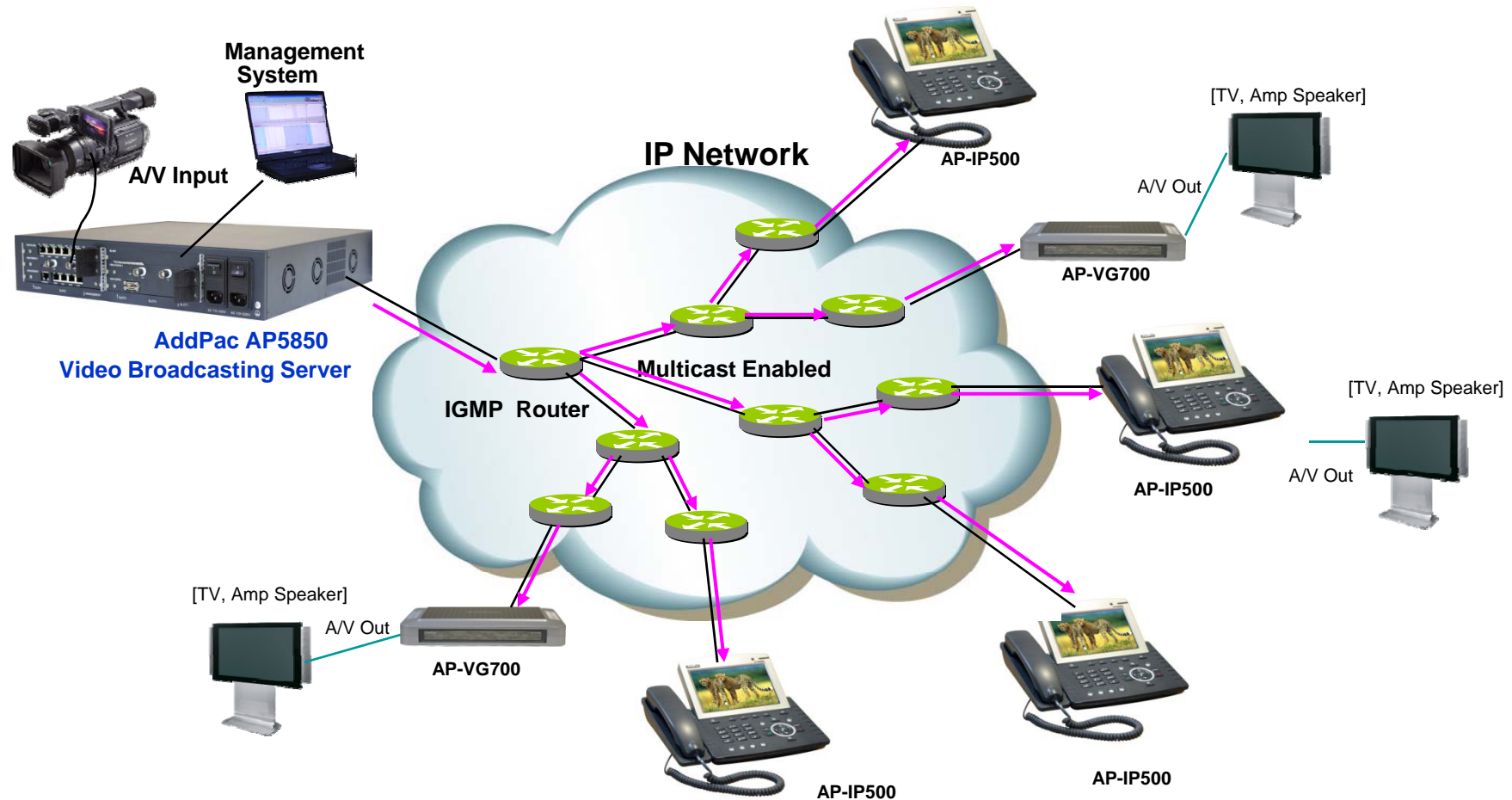

Audio/Video Real-time Broadcasting

AP5850 Multiservice Router

Audio and Voice Broadcasting Service via
Unicasting IP Network
(Video, Audio/Voice, and more...)

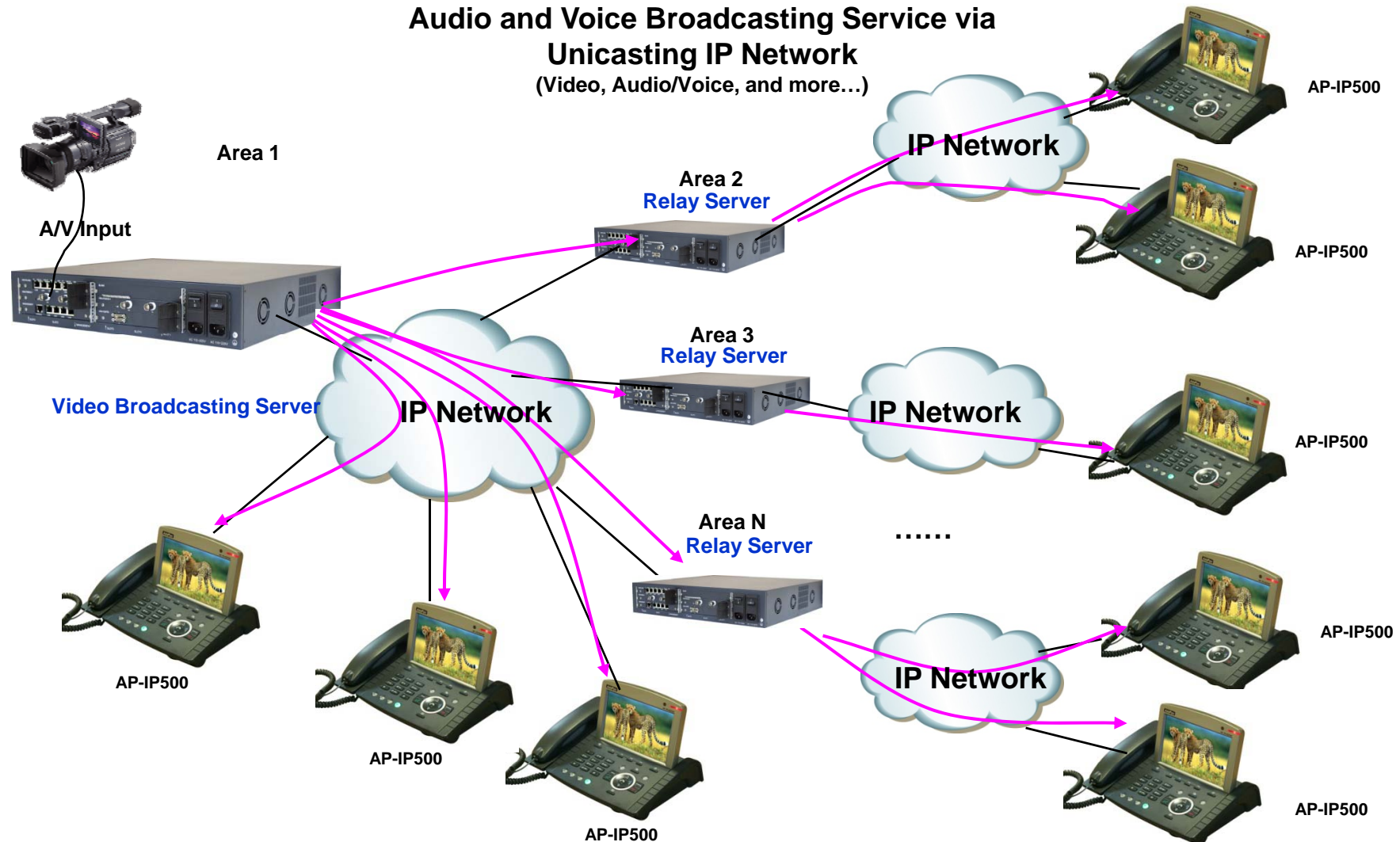

Media Encoder for VoD Service

AP5850 Multiservice Router

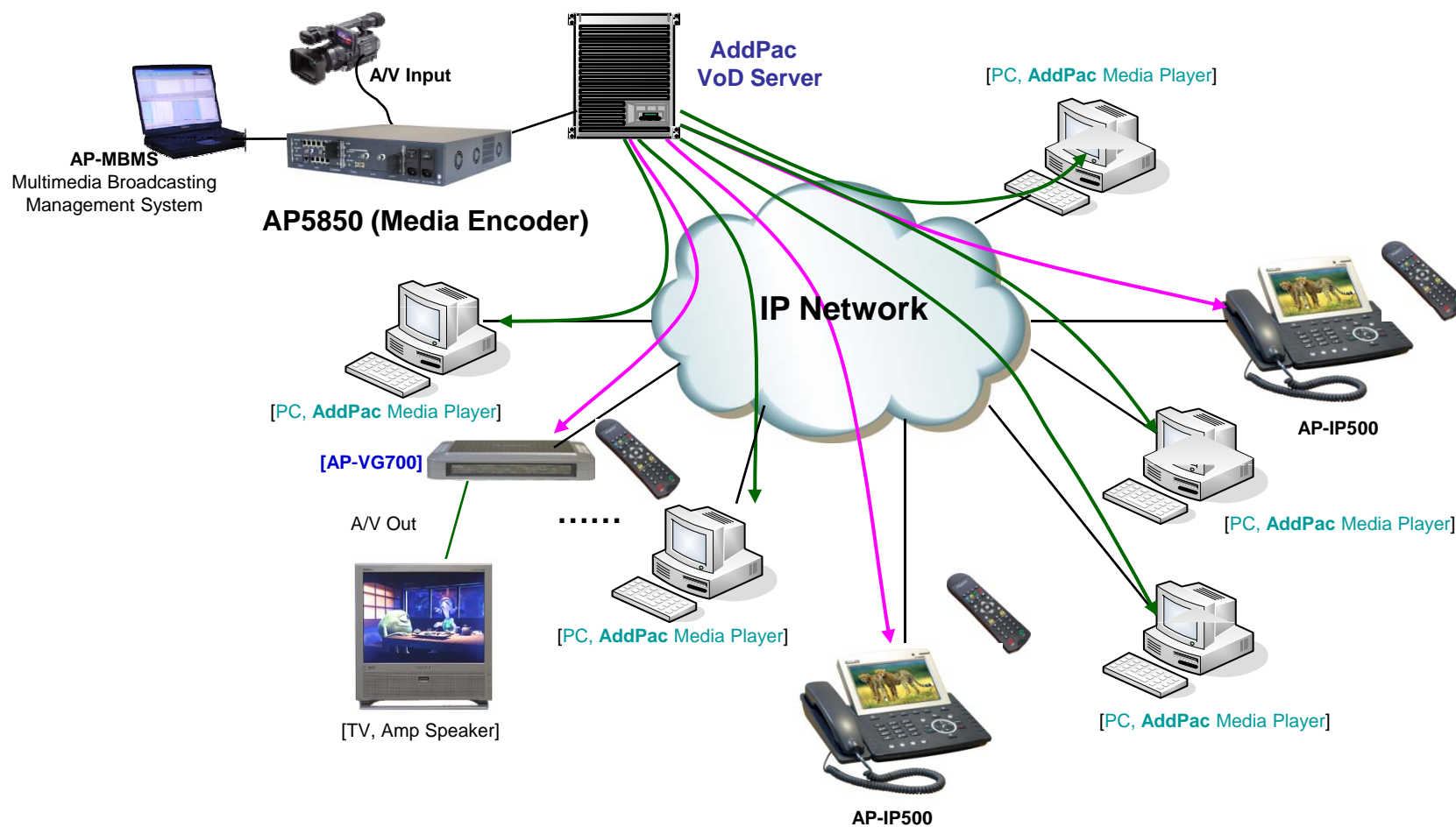

ATM Router Application

AP5850 Multiservice Router

Head Office

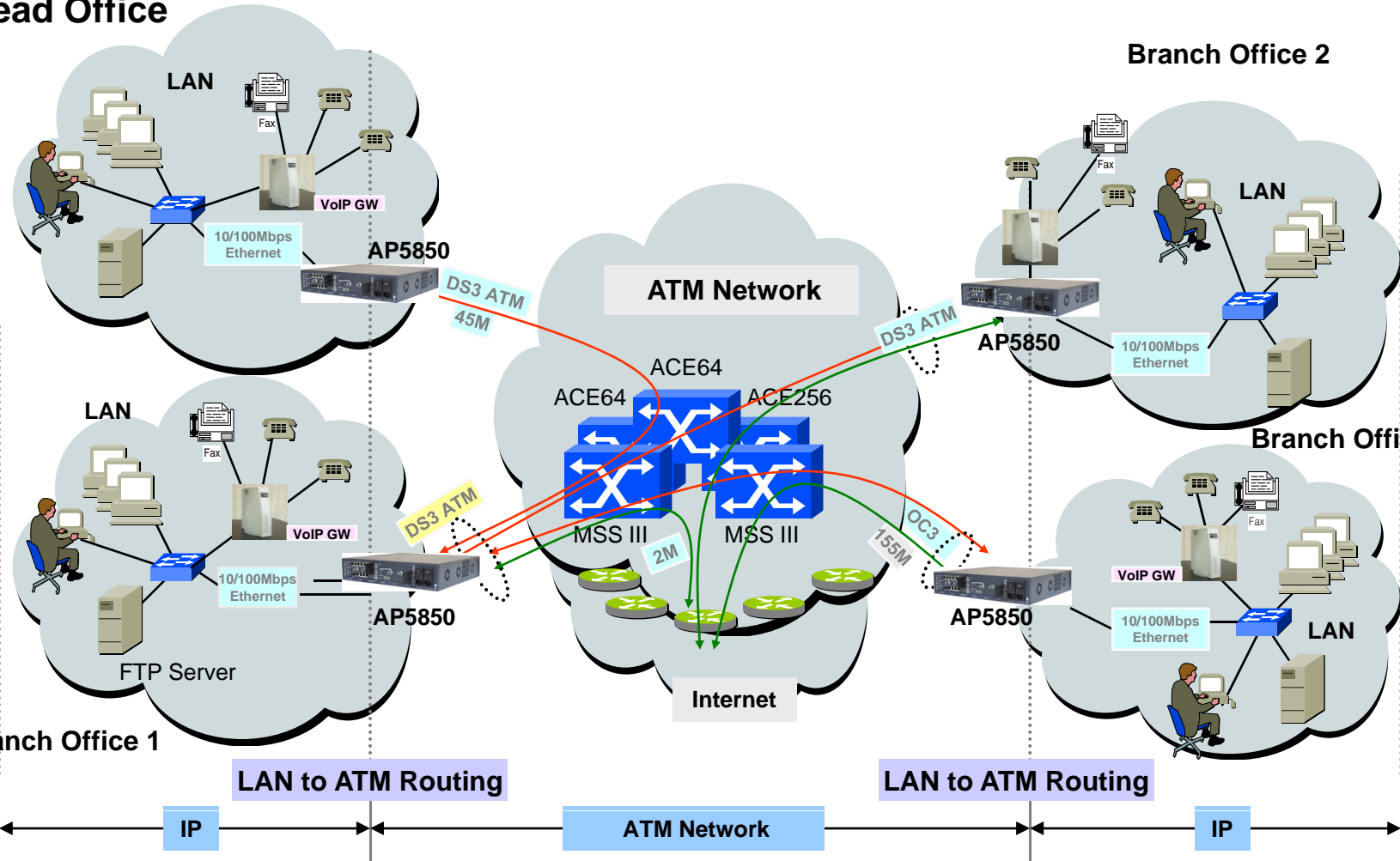

Multi-Channel V.35 Interface Router

AP5850 Multiservice Router

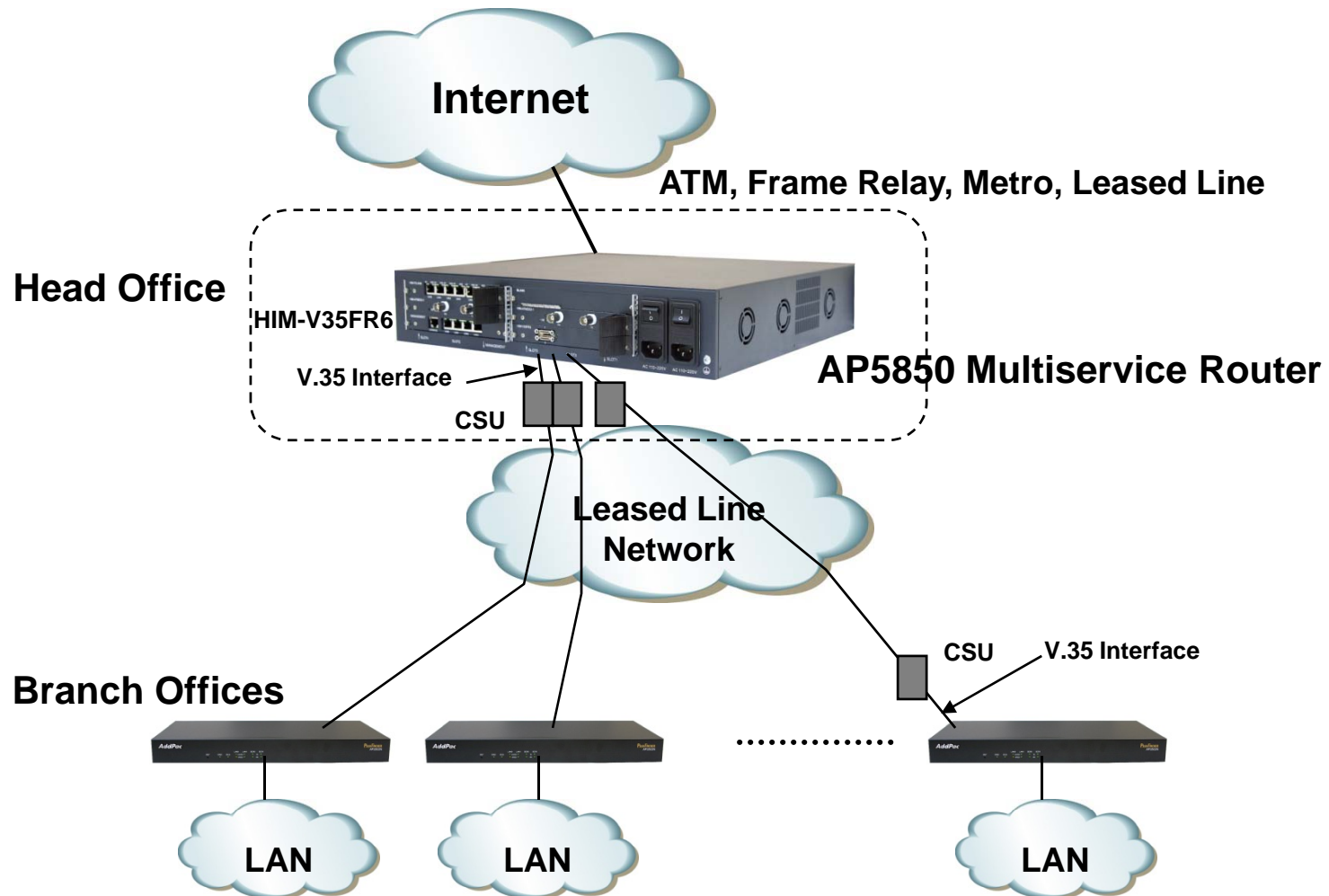

Ordering Information

- **AP5850 Multiservice Router Hardware**
 - AP5850 Multiservice Router Main Body
 - High-End RISC Microprocessor
 - 4-ports 10/100Mbps Fast Ethernet and 1-port RS-232C Console
 - Including Network Cable Set & Ext. Power Supply, etc.
 - Option Modules
- **Built-in APOS Internetworking Software for AP5850**
- **Including 1 Year Hardware Warranty**
- **Product Documents**
 - Install and Operation Guide (PDF)
- **Pricing**
 - AddPac Technology Regional Sales Manager
 - Authorized Sales and Marketing Representatives
 - Please Contact www.addpac.com



Thank you!

AddPac Technology Co., Ltd.
Sales and Marketing

Phone +82.2.568.3848 (KOREA)

FAX +82.2.568.3847 (KOREA)

E-mail sales@addpac.com