

IP Telephony Solution for Train Traffic Control Center (General Train)



AddPac

AddPac Technology

2012, Sales and Marketing

www.addpac.com

Contents

- IP Telephony Network Diagram for General Train Traffic Control Center (Korail)
- IP Telephony Solution Components (Example)
 - AP6800 Large Scale VoIP Gateway (Long Distance Support)
 - IPNext3000 Call Manager
 - AP-NR2000L IP Voice Recording Server
 - AP-MC1500 Voice MCU
 - AP2620 VoIP Gateway with Voice Recording Feature
 - AP-IP300 IP Phone
 - AP-PT50 Extend Speed-Dial Box
 - AP-SAC Smart Attendant Console
 - AP-SNMS Smart IP Telephony NMS

IP Telephony Network Diagram for Korail(cont..)

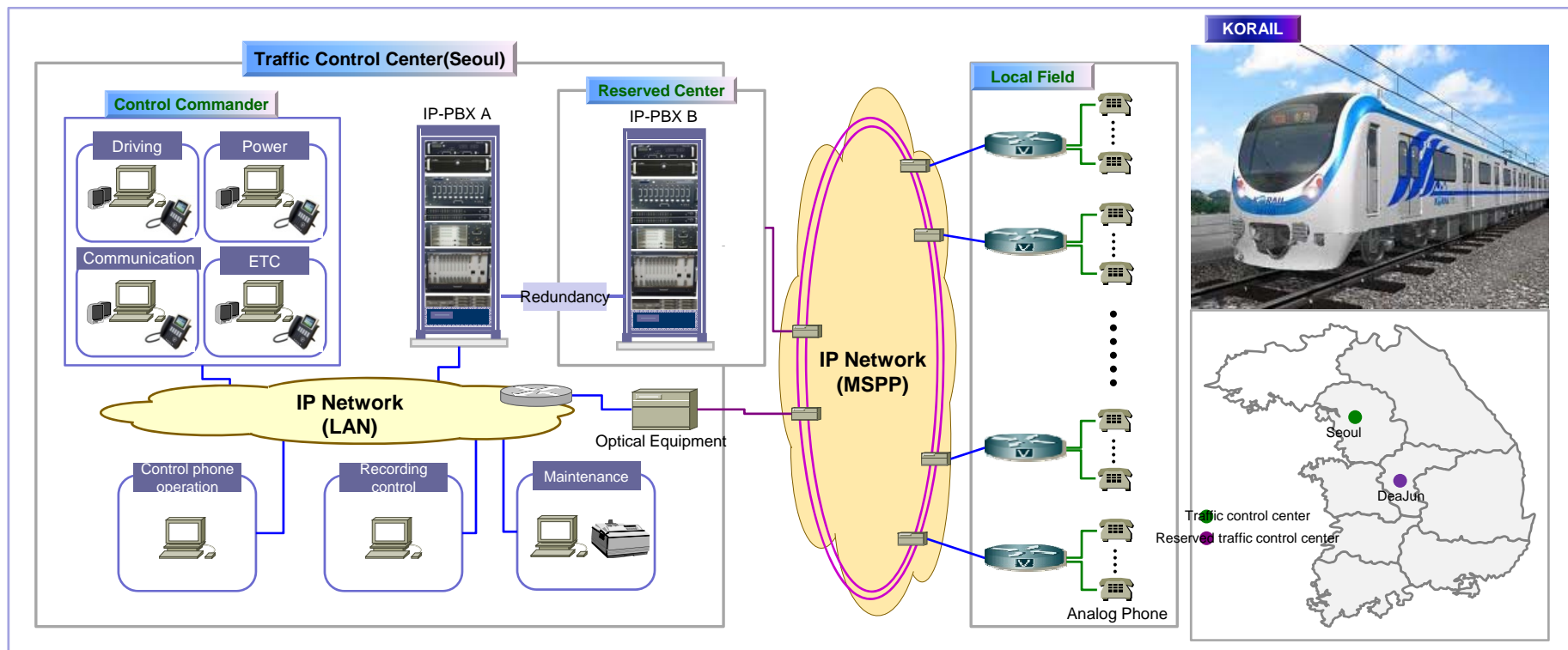

IP Telephony Network Diagram for Korail

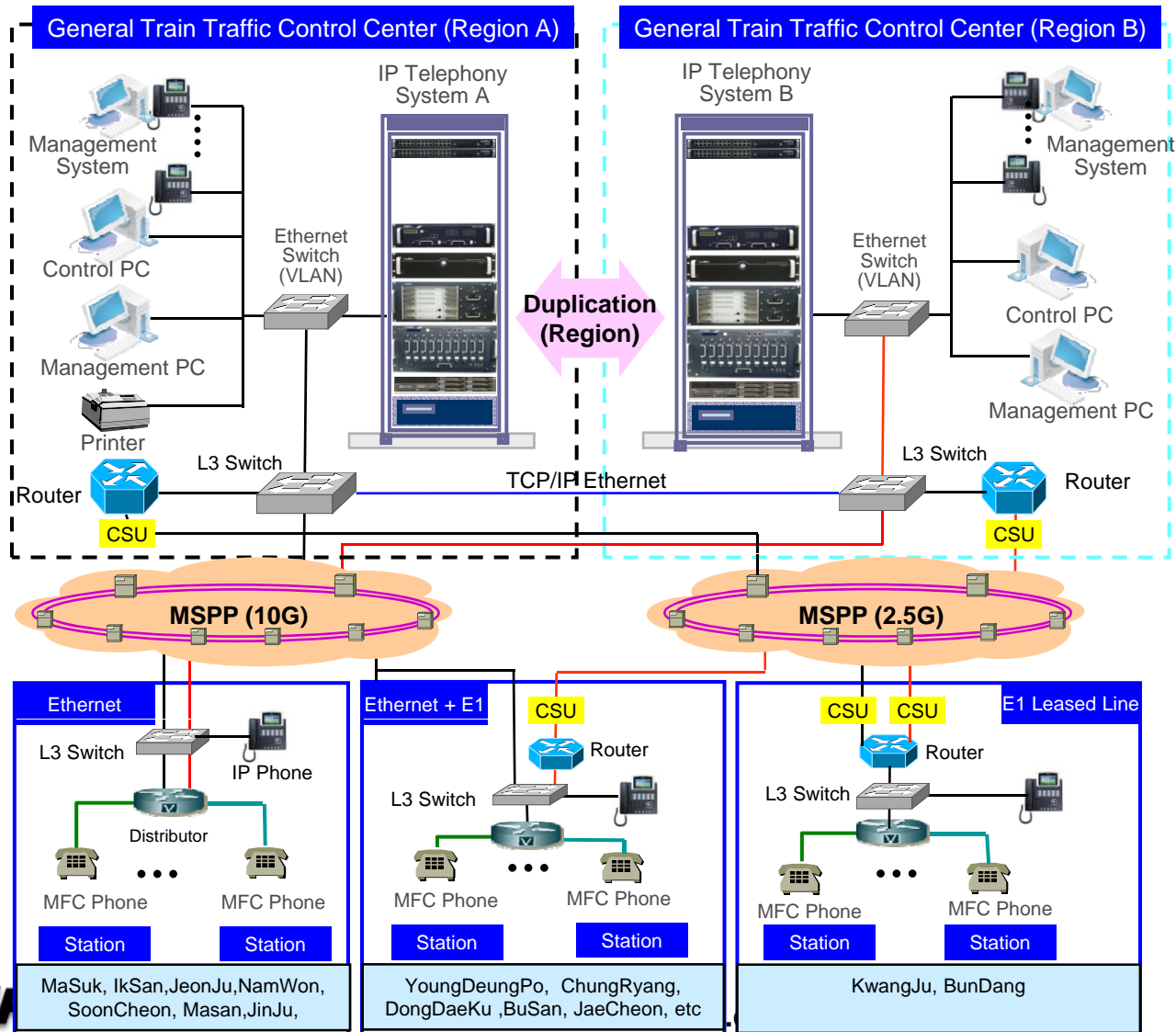

Add





IP Telephony Solution Components



AP6800 VoIP Gateway

(Large Scale, Long Distance)

Large Capacity VoIP Gateways

Product	AP6500	AP6800
		
Available VoIP Modules	AP-N1-FXS32 AP-N1-FXO32	AP-N1-FXS32 AP-N1-FXO32
Analog Ports	Up to 128 (32-Port Module x 4)	Up to 256 (32-Port Module x 8)
Signaling	SIP, H.323	SIP, H.323
CPU Redundancy (Dual CPU)	Support (Option)	Support (Option)
E&M	N/A	N/A
Module Slot for VoIP Module	4 Slots	8 Slots
LAN Port	2	2
Console	1	1
Dual Power Supply (Option)	Support	Support

Main Features

AP6800 Large Scale VoIP Gateway

- SIP/MGCP Concurrent **Redundancy** Stack Embedded
- High Performance RISC Processor
- Dual CPU Redundancy (Active, Standby) for System Stability
- Dual Power Redundancy (AC, DC) selectable at ordering
- Hot-Swap Function Support
- Up to 256 Analog Interface Port (32Port Board x 8 Ea) Support
- Two(2) 10/100/1000Mbps Giga-Bit Ethernet Interface
- G.711/G.726/G.723/G.729, T.38 Fax , VAD, etc
- Powerful Network Protocols (PPPoE, DHCP, Static Routing, etc)
- Firmware Upgradeable Architecture
- VPMS (VoIP Plug&Play Management System) for Large Scale Deployment
- Advanced Voice QoS Mechanism

Hardware Specification

AP6800 Large Scale VoIP Gateway

RISC
CPU

High-end
DSP



Console Port

Active CPU

Standby CPU

32Port FXS Board

Power Module A

Power Module B

FAN Tray

AC Power Input

32 Port Analog Interface Connector

Giga Ethernet Interface

AddPac

www.addpac.com

Hardware Specification

AP6800 Large Scale VoIP Gateway

RISC
CPU

High-end
DSP

Hardware Specifications

AP6800 VoIP Gateway	Basic Specifications
Dual Redundancy CPU	High-End RISC Microprocessor, Dual Redundancy CPU (Active, Standby)
Voice Interface	Up to 256-Port FXS Voice Interface Up to 256-Port FXO Voice Interface
	32-Port Analog FXS Board, FXO Board
Ethernet Interface	2-Ports 10/100/1000Mbps Giga Ethernet Interface(RJ-45)
Flash Memory/CPU	8Mbyte High-speed Flash Memory
Base Memory/CPU	64/128Mbyte High-speed SDRAM
Power Requirement	Dual Power Supply / VAC 110~220V, 50/60Hz, 880Watt
Operating Temperature	0°C ~ 45°C (32 °F ~ 122°F)
Storage Temperature	-40°C ~ 85°C (-40°C ~ 185°F)
Relative Humidity	5% ~ 95% (Non-condensing)
Dimensions	400mm x 482mm x 340mm (H x W x D)



CPU Board

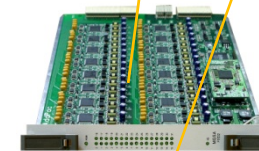

32Port
FXS Board



Power Supply
Board

IPNext3000 Call Manager



Main Features

IPNext3000 Call Manager

- IP based Advanced PBX Solution
- IPv4/IPv6 based Dual Network Protocol Support
- Internal/External RTP Proxy Function Support
 - External RTP Proxy Server for Private Address : AP-RS2000
- Internal/External Presence Function Support with Smart Messenger
 - External Presence Server : AP-PS2000
- Powerful Management and User Friendly Features
- Fault Tolerant and Scalability Architecture
- High-performance Video, Audio, and Voice Service
- Firmware Upgradeable Architecture
- Dual System Redundancy Architecture
 - Two(2) 3.5 Inch Hard Disk (RAID 1) / System
 - Two(2) Gigabit Ethernet Interface / System
- Dual Redundancy Power Module

Hardware Specification

IPNext3000 Call Manager

RISC
CPU

- 64bit High-End Microprocessor Computing Power
- Main Chassis
 - Dual Redundancy CPU Boards for System Fault Tolerant
 - Two(2) 10/100Mbps Gigabit Ethernet
 - One(1) RS-232C Console (RJ45)
 - Two(2) 3.5 Inch Hard Disk Interface Slot (RAID 1)
 - Dual Redundancy Power Supply Module
 - Hot-Swap Features



Hardware Specification

IPNext3000 Call Manager

RISC
CPU

IPNext3000 Front Side

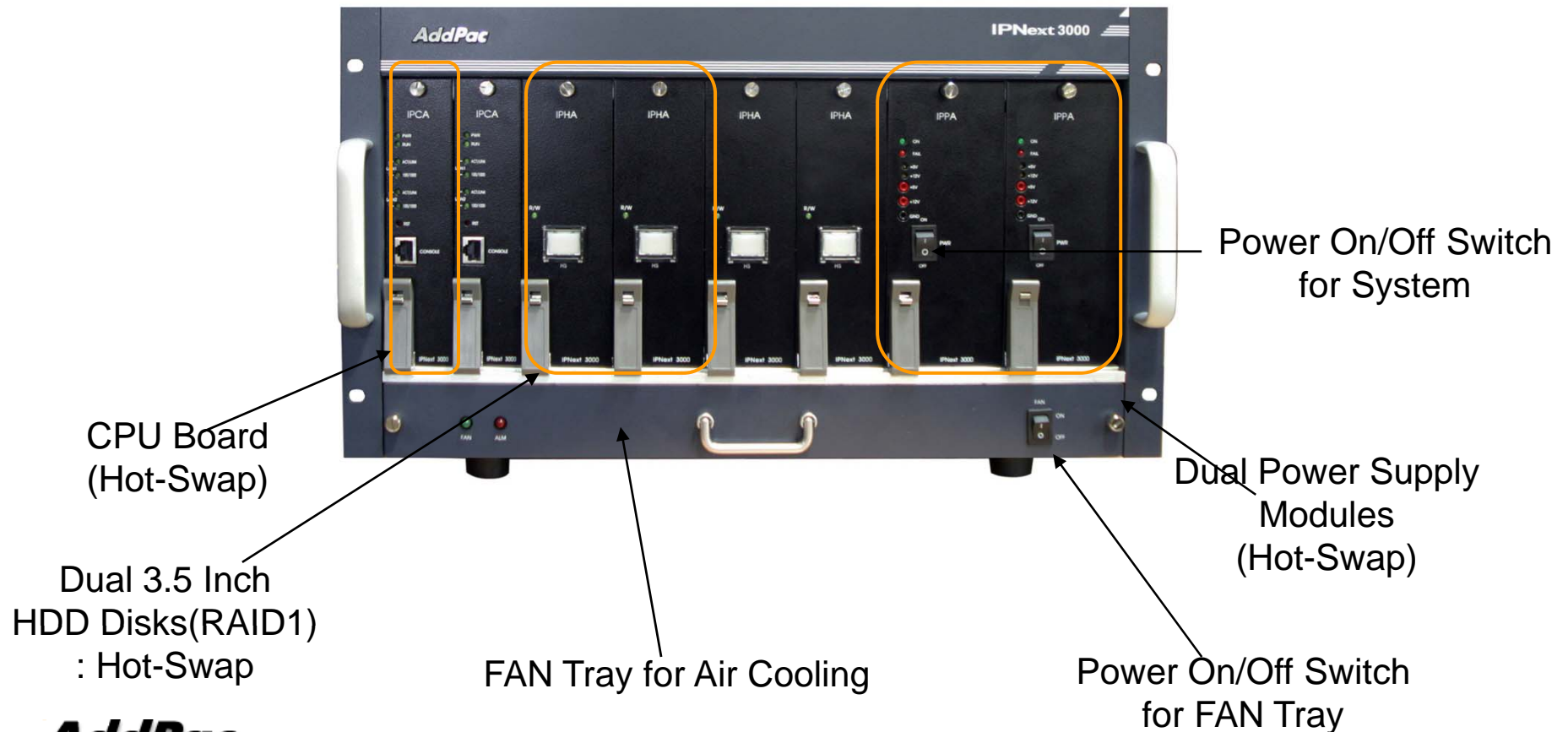

AddPac

www.addpac.com

Hardware Specification

IPNext3000 Call Manager



IPNext3000 Back Side

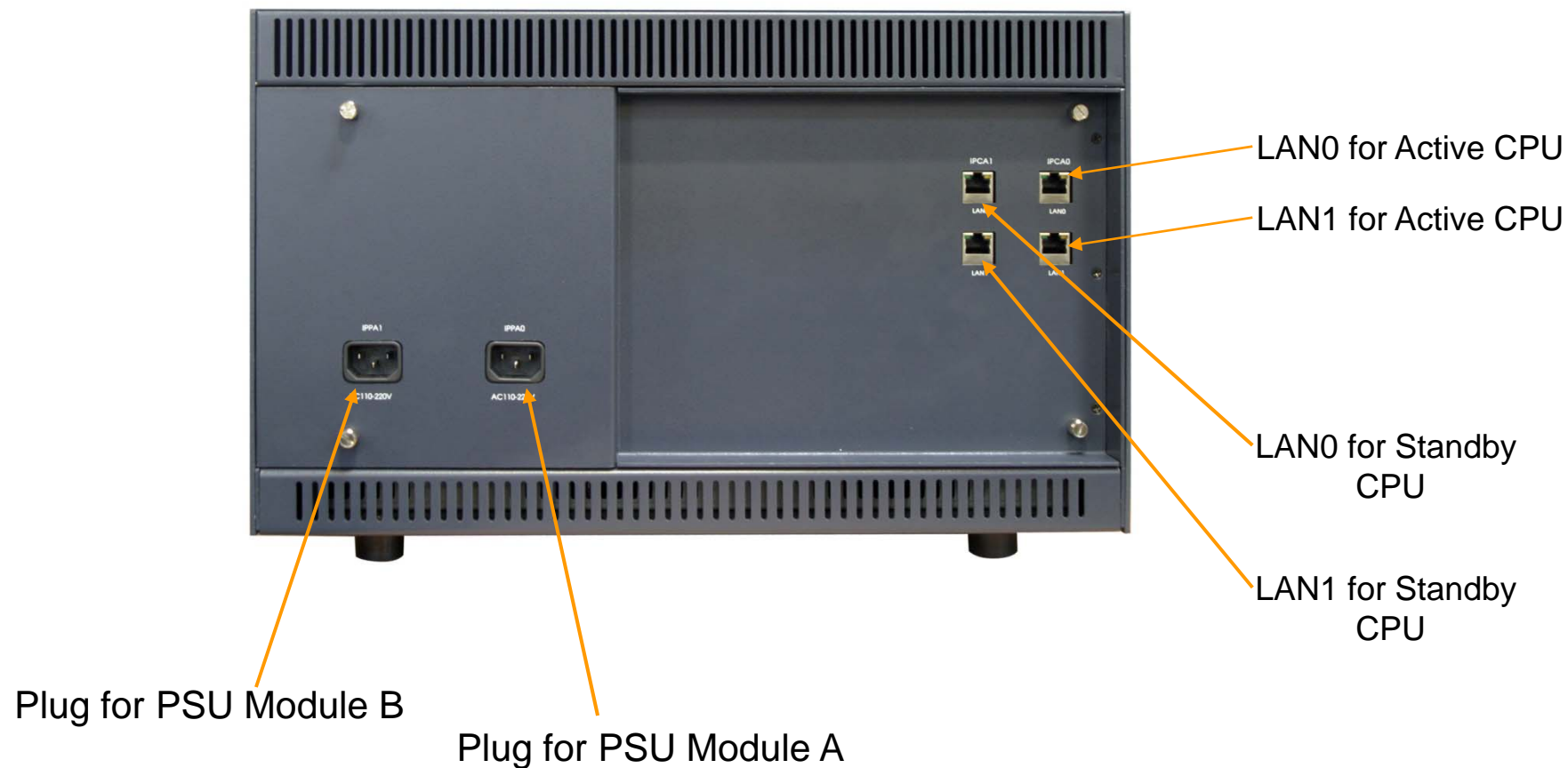

System Redundancy Features

IPNext3000 Call Manager

IPNext3000 System Block Diagram

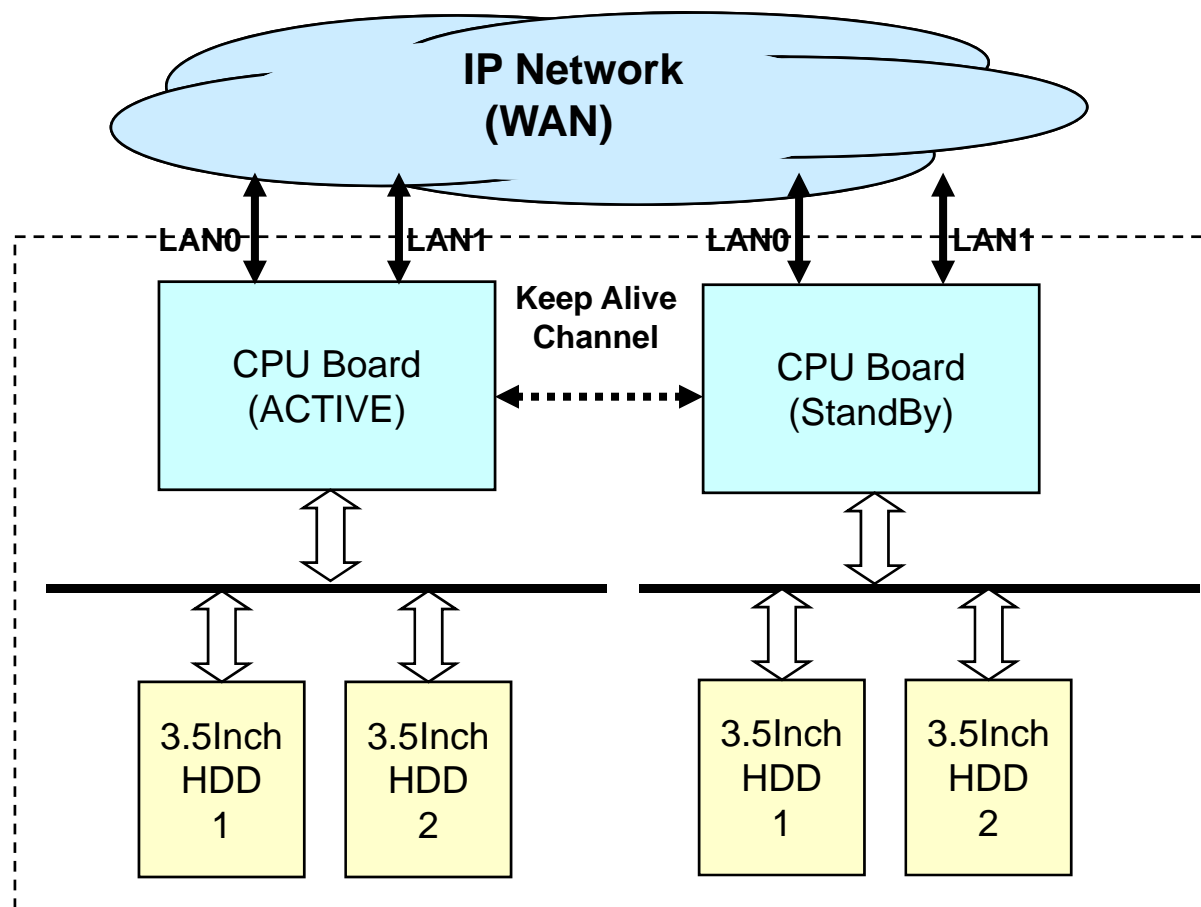

System Redundancy Features

IPNext3000 Call Manager

- Active– Active Duplication Scheme
- Active – Standby Duplication Scheme
- VRRP based Duplication Scheme

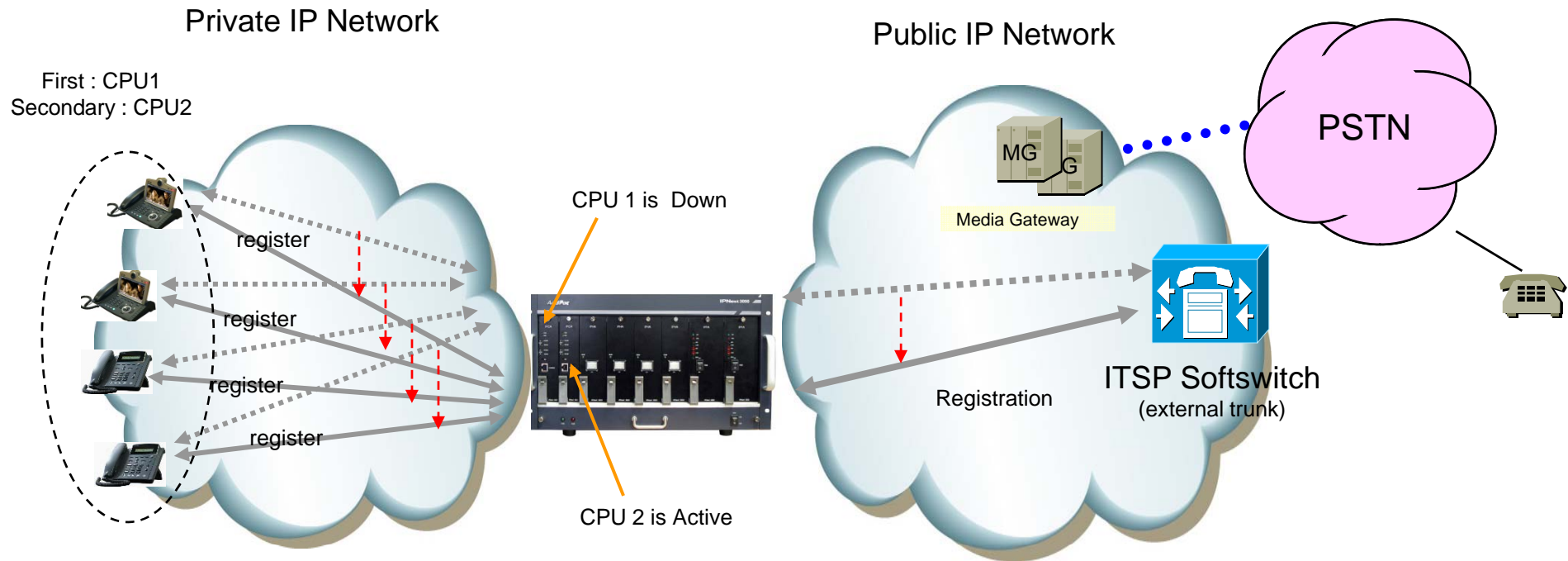

Active – Standby Duplication Scheme (example)

AP-NR2000L IP Voice Recording Server

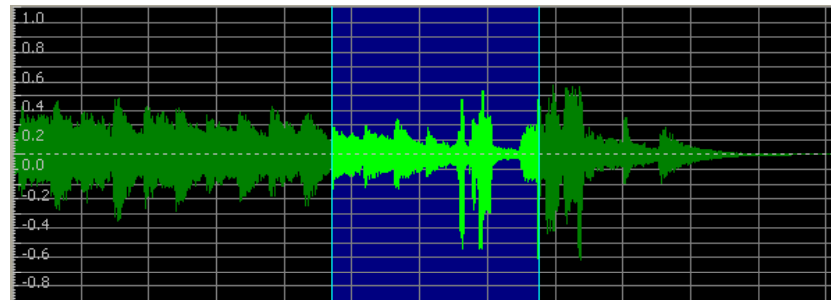

Main Features

AP-NR2000L IP Voice Recoding Server

- IP based Network Voice Recording Server
- Powerful Management and User Friendly Features
- Fault Tolerant and Scalability Architecture
- High-performance Voice Recoding Service
- External Voice Transcoder(ex:AP-VTC1000) Interworking Support
- Firmware Upgradeable Architecture
- Two(2) Gigabit Ethernet Interface
- Ten(10) 3.5Inch IDE type Hard Module Slot
- RAID 1 Hard Disk Backup
- Smart Digital Voice Recording Management Software

Hardware Specification

AP-NR2000L IP Voice Recoding Server

High-End
RISC
CPU

- RISC Microprocessor Computing Power
- Main Chassis
 - Network Interface
 - Two(2) 10/100/1000Mbps Gigabit Ethernet
 - One(1) RS-232C Console (RJ45)
 - Ten(10) Hard Disk Interface Slot for RAID1 Configuration

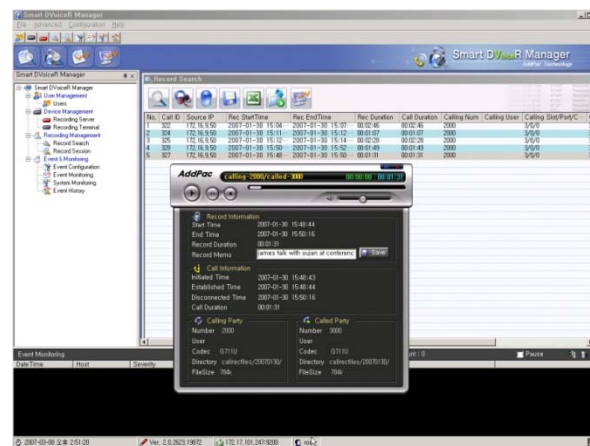

Hardware Specification

AP-NR2000L IP Voice Recoding Server

High-End
RISC
CPU

Front Side

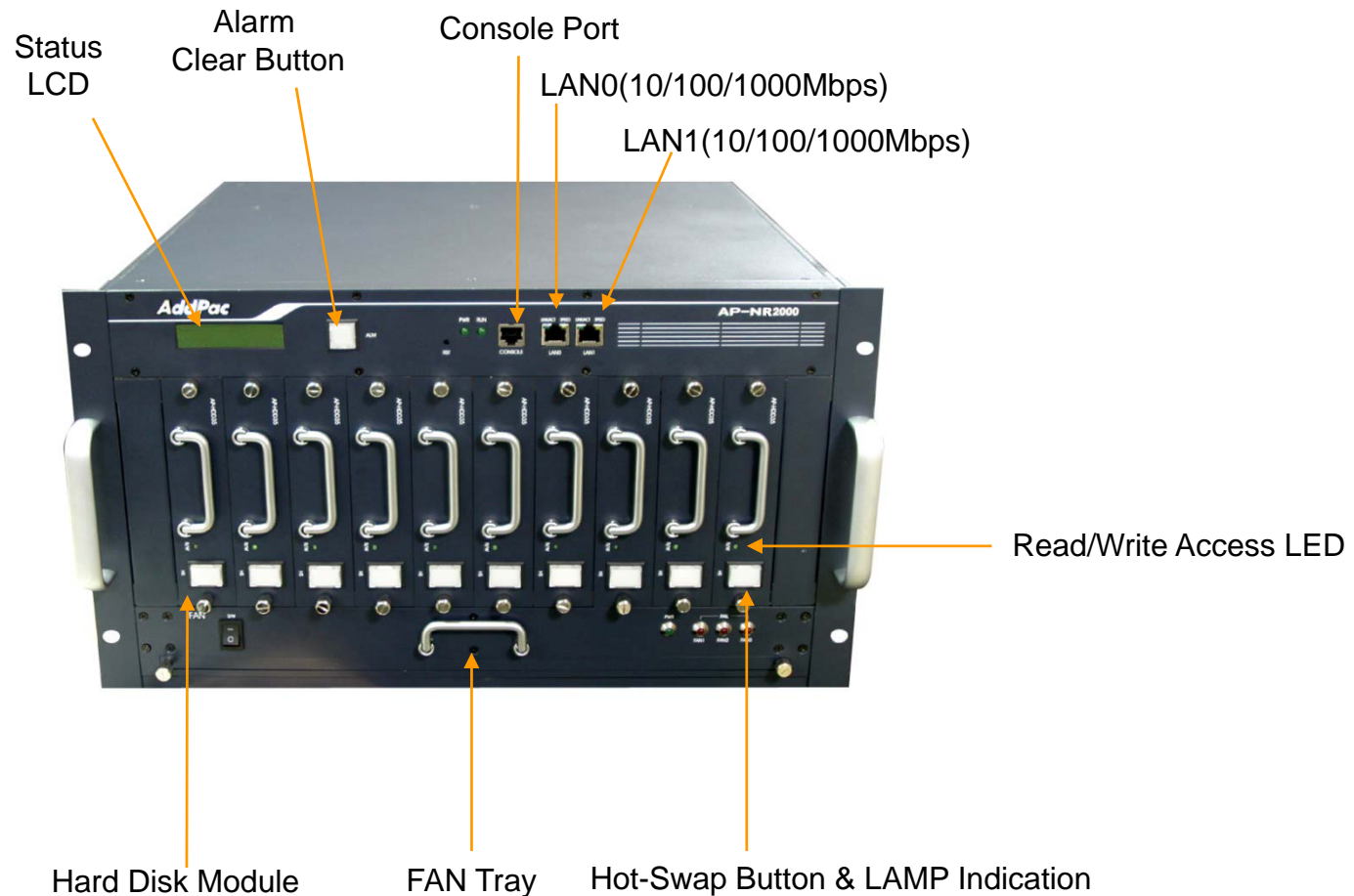

Hardware Specification

AP-NR2000L IP Voice Recoding Server

High-End
RISC
CPU

Back Side



Power Supply
Module

Power ON/OFF
Switch

Power Inlet

Smart DVoiceR Management Program

AP-NR2000L IP Voice Recoding Server

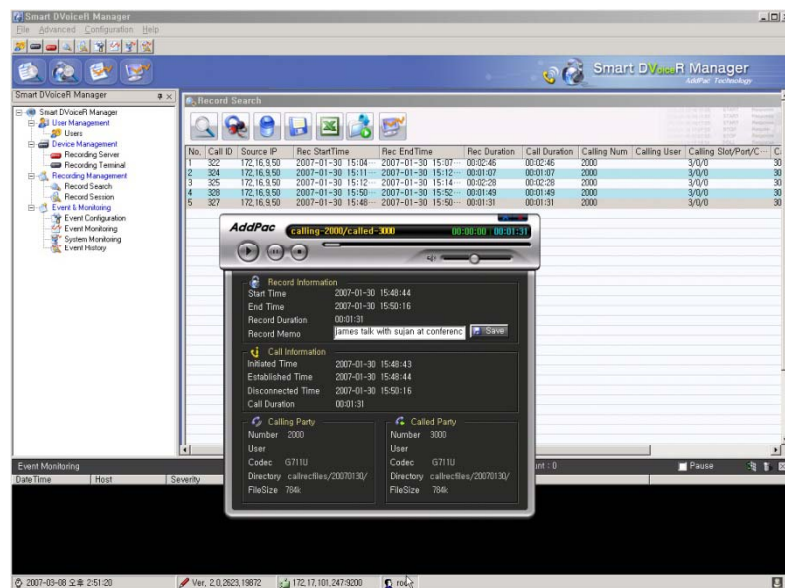

- Call History Management (search/modify/delete/save)
- Media Play Management (Play/Stop/Seek/Pause)
- Live Call List Management, Live Call Monitoring
- Local Backup (File Manager Support, PC HDD, DVD) and Local Play
- User Management (registration/modify/delete/search)
- Server Status (CPU/Memory/HDD) & Event Monitoring
- Waveform Analyzing Function
- Recording Source Management (VoIP Gateway, IP Phone, etc)
- Live Recording Board

Network Service Diagram

AP-NR2000L IP Voice Recoding Server

◆ Enterprise Application
(Digital Interface)

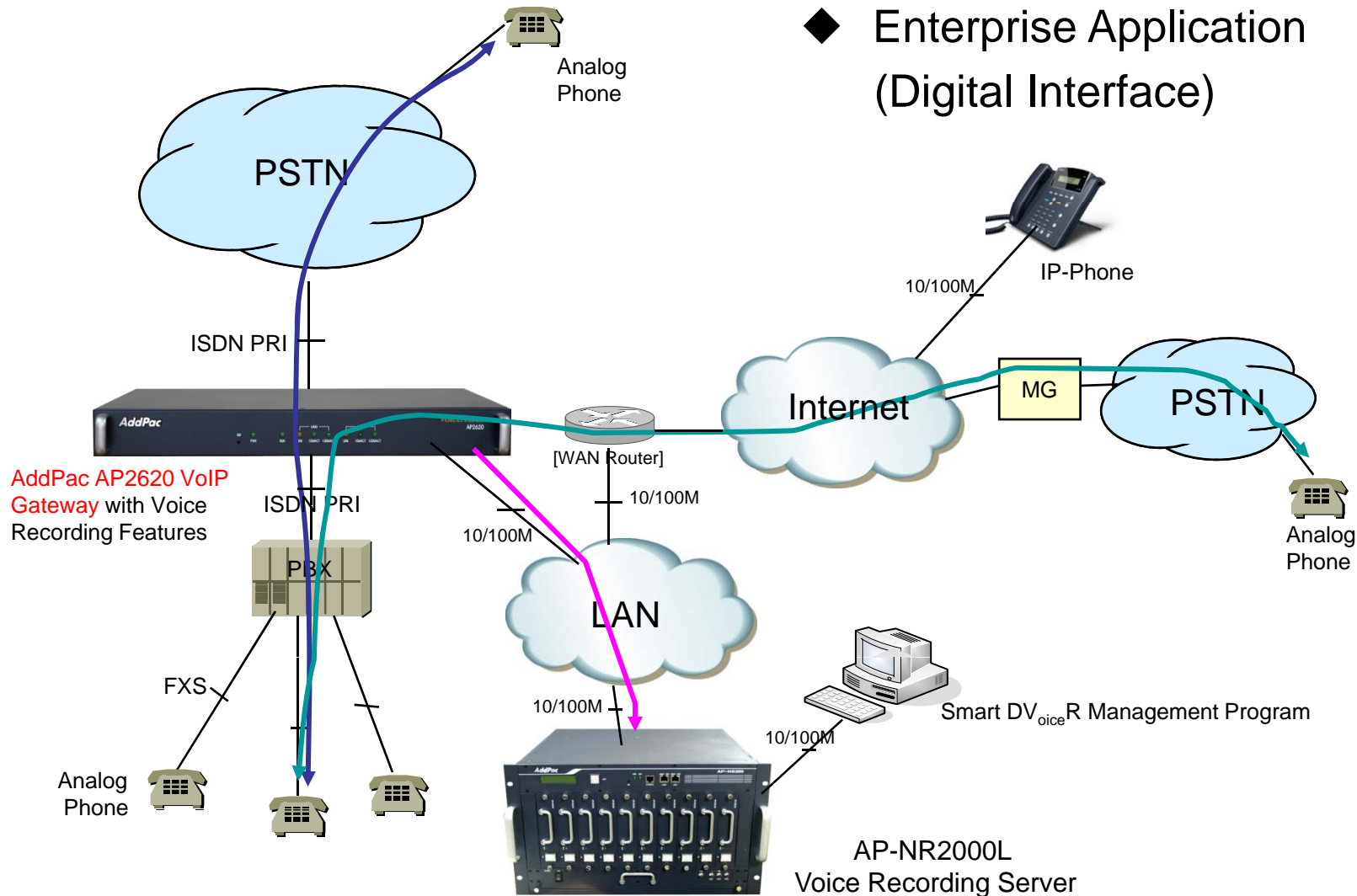



AP-MC1500 Audio MCU

Main Features

AP-MC1500 Voice MCU

- IP based Hardware Audio Mixing Solution
- Two(2) DSP Module Slots for Audio Mixing
- 64Ch, 128ch Audio Mixing DSP Modules
- Compact PCI Style Hot-Swap Support
- Support Various Conference System Model
- Scalability and Flexibility
- High-performance Voice Mixing Service
- SIP and H.323 VoIP Signaling Support
- Various Voice Codec Support (G.711,G.729, G.723, etc)
- Two(2) 10/100Mbps Fast Ethernet Interface
- Firmware Upgradeable Architecture
- Audio Solution with Outstanding Network Service Capability

Hardware Specification

AP-MC1500 Audio MCU

PowerPC
CPU

High-end
DSP

- High Performance RISC Microprocessor Computing Power
- Built-in High-end Programmable DSP Hardware Architecture
- Main Chassis
 - Network Interface
 - Two(2) 10/100Mbps Fast Ethernet
 - One(1) RS-232C Console (RJ45)



Hardware Specification

AP-MC1500 Audio MCU

PowerPC
CPU

High-end
DSP



DSP Module

Hot-Swap Ejector

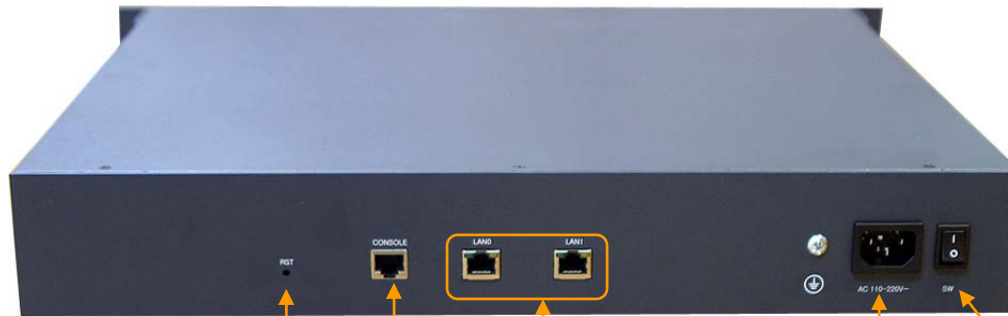

Reset

Console
Port

Two(2)
LAN Port

Power Inlet

Power Switch

Hardware Specification

AP-MC1500 Audio MCU

PowerPC
CPU





High-end
DSP

- MCU Module (HIM-AMCU128)
 - High quality Audio Mixing
 - 128Channel Audio Mixing
 - Compact PCI Style Hot-Swap Function
 - High-End Programmable DSPs
 - Parallel DSP Processing for High Quality Audio Mixing
 - Concurrent Different Audio Codec Support
- MCU Module (HIM-AMCU64)
 - High quality Audio Mixing
 - 64 Channel Audio Mixing
 - Compact PCI Style Hot-Swap Function
 - High-End Programmable DSPs
 - Parallel DSP Processing for High Quality Audio Mixing
 - Concurrent Different Audio Codec Support
 - Cascade Support

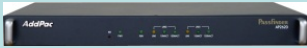

AP2620 VoIP Gateway with Voice Recording Feature

VoIP Gateways with Voice Recording Extension

Product	AP2620	AP2640	AP2650	AP-MG3000
				
Available Modules	AP-FXS4 AP-FXO4 AP-FXS2O2 AP-E&M4 AP-E1	AP-FXS8 AP-FXO8 AP-FXS4O4 AP-E&M8 AP-E1	AP-FXS8 AP-FXO8 AP-FXS4O4 AP-E&M8 AP-E1	APv2-1E1 APv2-2E1 APv2-4E1
Analog Ports	Up to 8	Up to 32	Up to 32	N/A
Signaling	SIP, H.323	SIP, H.323	SIP, H.323	SIP, H.323
Digital E1/T1	Up to 2E1/T1	Up to 2E1/T1	Up to 2E1/T1	Up to 4E1/T1
E&M	Support	Support	Support	N/A
Module Slot	Two(2)	Four(4)	Four(4)	Two(2)
LAN Port	2	2	2	2
Console	1	1	1	1
Power	Single PSU	Single PSU	Dual PSU	Single PSU

Main Features

AP2620 VoIP Gateway

- Voice Recording Interface Support
- FXS, FXO, E&M, Digital E1/T1 VoIP Interface
- Two(2) Module Slots for Analog/Digital VoIP Interface
- Up to 2E1/T1 Digital Interface
- Up to 8 Port Analog Interface
- IPv4/IPv6 Address Support
- SIP, H.323, MGCP VoIP Signaling Support
- Firmware Upgradeable Architecture
- Rack Mountable Chassis



AP-IP300 IP Phone



Main Features

AP-IP300 IP Phone

- 4.3 Inch Color LCD Display
- External I/O Interface
 - Audio In/Out
 - Two(2) Fast Ethernet Interface
 - PSTN FXO Interface (optional)
- PoE (Power over Ethernet) Support
- 25 Speed Dial button with Presence Indication Lamp
- Audio Broadcasting Controller & Terminal
- Providing Powerful Push-to-Talk Service
- Powerful Color GUI
- IPv4/IPv6 Address Support
- SIP, H.323 Signaling Support
- High-end Error Resilient Against Various Packet Error

Hardware Specification

AP-IP300 IP Phone

- RISC+DSP Microprocessor Computing Power (Dual Processor Architecture)
- High Quality 4.3 Inch Color LCD Panel
- 25 Speed Dial Key & User Presence Indication LED
- Optional PSTN Backup Interface
 - FXO Interface
- High quality Audio and Voice Interface
 - Stereo Audio Input Connector
 - Stereo Audio Output Connector
- Network Interface
 - Two(2) 10/100Mbps Fast Ethernet
- USB Host Mode Interface
 - USB Memory(Flash, HDD), etc
- Power Supply
 - Power over Ethernet
 - External Power Adaptor (5V, 3A)



Hardware Specification



AP-IP300 IP Phone





AP-PT50 Extend Key Box

IP Extend Key Pack Comparison Table

Model	AP-PT100	AP-PT50	AP-PT20
Service Features			
Key Type	7 inch LCD Touch Screen	Push Button with User Presence Indication LAMP	Push Button with User Presence Indication LAMP
Key Number	Default : 9(row) x 4(column) = 36	60 Key	40 Key
User Presence Indication	Support	LED on, LED off, LED Blink	LED on, LED off, LED Blink
Multiple Cascading	Support	Support	Support
Speaker	Support	Support	Support
LAN Port	2	2	2
PoE(Optional)	Support	Support	Support
Application	IP Phone or Video Phone Extend Key Pack	IP Phone or Video Phone Extend Key Pack	IP Phone or Video Phone Extend Key Pack

Main Features

AP-PT50 IP Extend Key Pack

- Speed Dialing Terminal with User Presence Indication LAMP
- 60 (3 Column x 20 Row) Speed-Dial Key Buttons
- Inter-working with IP Terminal, Presence Server, Call Manager
- Multiple Terminal Cascading Feature
- User Presence Indication LED (on, off, blink)
- User Presence Group Feature
- Firmware Upgradeable Architecture
- PoE (Power over Ethernet) Function

Hardware Specification

AP-PT50 IP Extend Key Pack

RISC
CPU

- RISC+DSP Microprocessor Computing Power
- 60 Speed Dial Key with User Presence LAMP
- Optional PoE (Power over Ethernet) Interface
- Network Interface
 - Two(2) 10/100Mbps Fast Ethernet
- Power Supply
 - Power over Ethernet (Option)
 - External Power Adaptor (5V, 2A)
 - Power Switch
- Connector for Cascading



Hardware Specification

AP-PT50 IP Extend Key Pack

RISC
CPU

Front Side

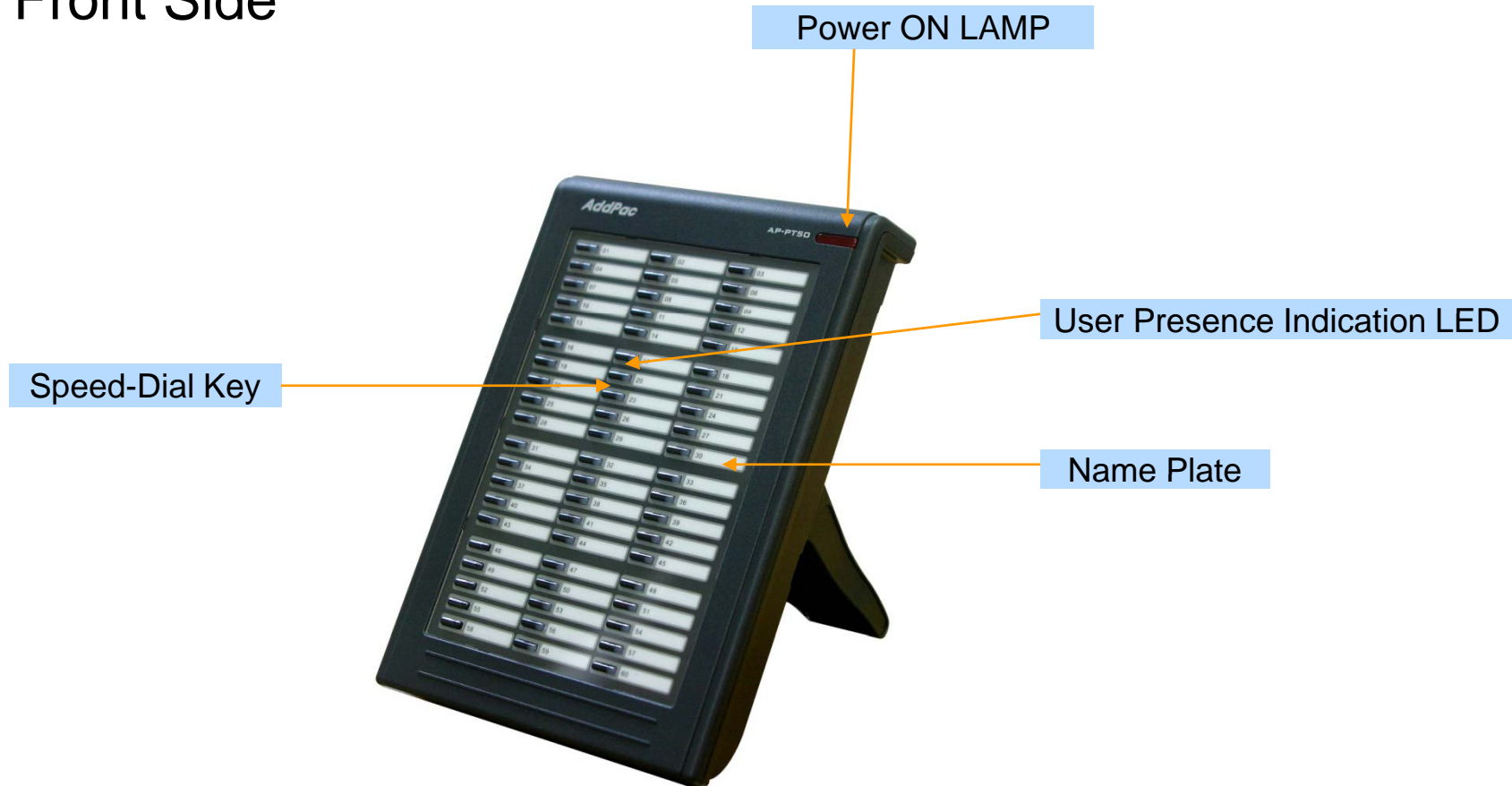



Hardware Specification

AP-PT50 IP Extend Key Pack

RISC
CPU

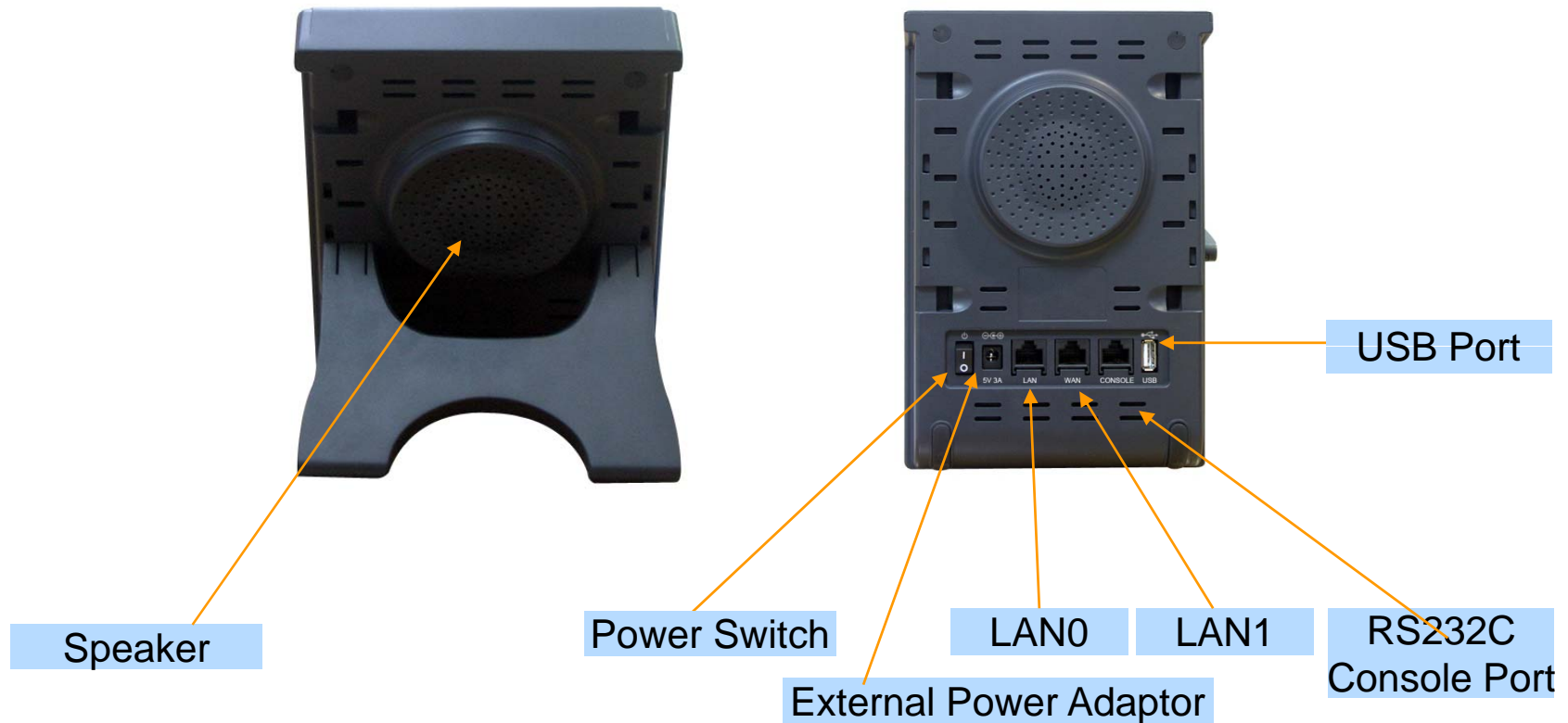
Back Side





AP-SAC Smart Attendant Console (Touch Screen Version)

Contents

- Overview
- Touch Screen based Attendant Console System Diagram
- Touch Screen based Attendant Console Feature
- Touch Screen based Attendant Console UI
 - Login Feature
 - Main Screen Feature

Overview

Support Efficiently Call Routing and Smart Presence Service

- Touch Screen based Attendant Console Function
 - Support Call Routing Service
 - Support User Presence Information
 - Support Phone Number Presence Information
 - Support Attendant Phone Call Control
 - Support Call Status Display
 - Support Group Call(Conference)
 - Support Various Monitoring Group

Touch Screen based Attendant Console System Diagram

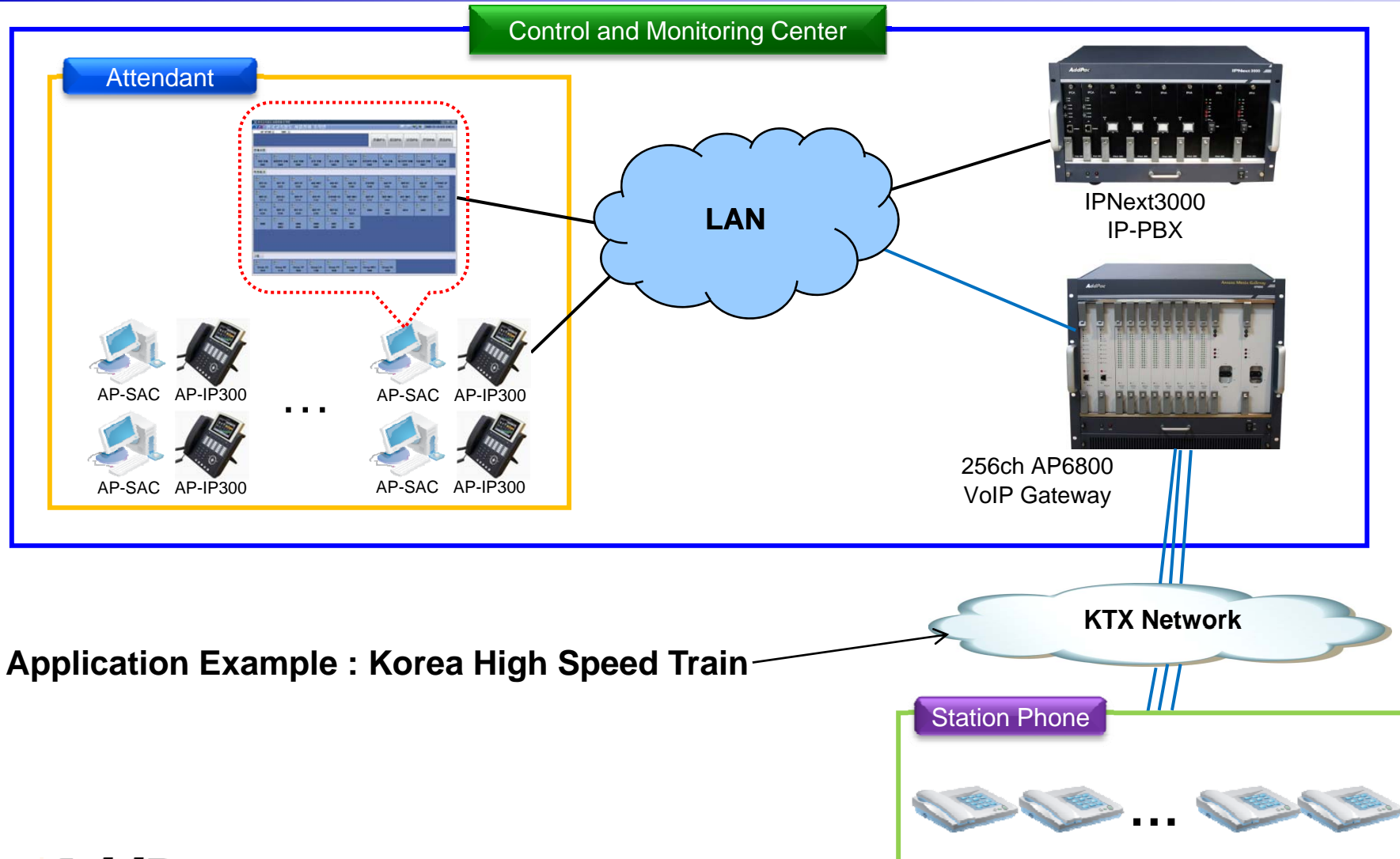

Application Example : Korea High Speed Train

Touch Screen based Attendant Console Feature

- User Login Service
 - User Login and Logout Feature
- Monitoring and Group Management Service
 - Support Various Group
 - Attendant and Direct Phone Group
 - Office Phone Group
 - Conference Call Group
 - Support Group Management Feature
 - Add Group, Rename Group, Delete Group
 - Add User, Delete User
 - Add Conference Room, Delete Conference Room

Touch Screen based Attendant Console Feature

- Monitoring and Group Management Service
 - Presence Feature
 - Phone Presence Status
 - Online, Working, Away, Absence
 - Be In Conference, Call Busy
 - User Presence Status
 - PC Online, Phone Online, PC-Phone Online
 - Working, Away, Absence
 - Be In Conference, Call Busy
 - Display Call Status
 - Display Call Status Icon for Talking Time
 - Call Control Feature
 - Interoperate with Monitoring Phone Information
 - Manual Call Dial
 - Drag and Drop Call Transfer and Manual Call Transfer

Touch Screen based Attendant Console Feature

- Attendant Phone Call Control Service
 - Display Phone Call Status
 - Display Call Status Icon for Call Stat
 - Display Talking Call Status Icon for Talking Time
 - Support Multi-Call
 - Phone Call Control Feature
 - Dial to Monitoring Phone and Conference
 - Incoming Call Answer
 - Active Call Hold and UnHold
 - Call Transfer
 - Call Disconnect
 - Interoperate with Monitoring Phone Information
 - Drag and Drop Call Transfer and Manual Call Transfer

Touch Screen based Attendant Console User Login

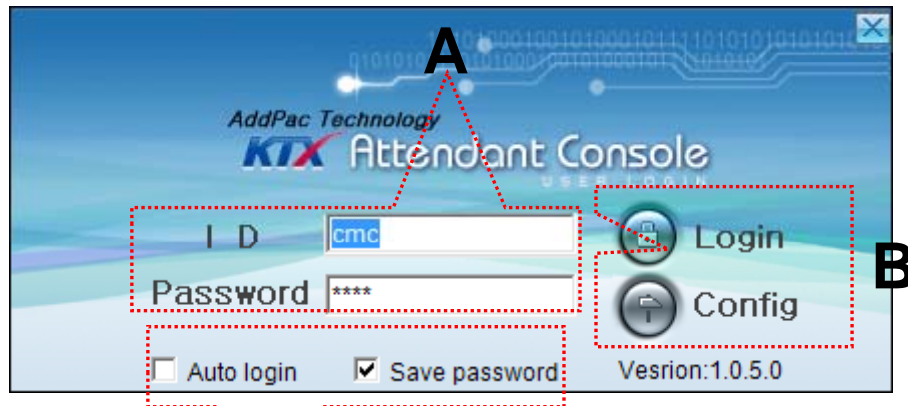

[Figure 1]

C

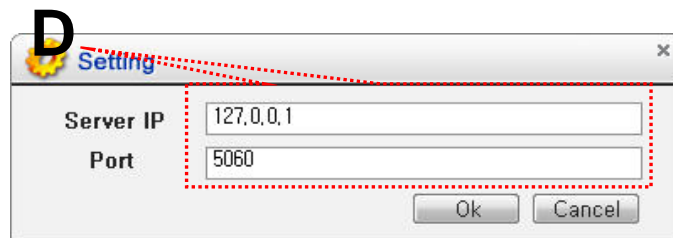

[Figure 2]



[Figure 3]

- Attendant Console Login
 - [Figure 1] shows the login picture of KTX Attendant Console program. “E” of [Figure3] is Icon of KTX Attendant Console Program.
 - When program is started initially, user should set the network configuration parameter such as IP address, Port number of Presence Server.[Figure2]
 - After inputting ID and Password, press the login button

Touch Screen based Attendant Console Main Screen –Call Control

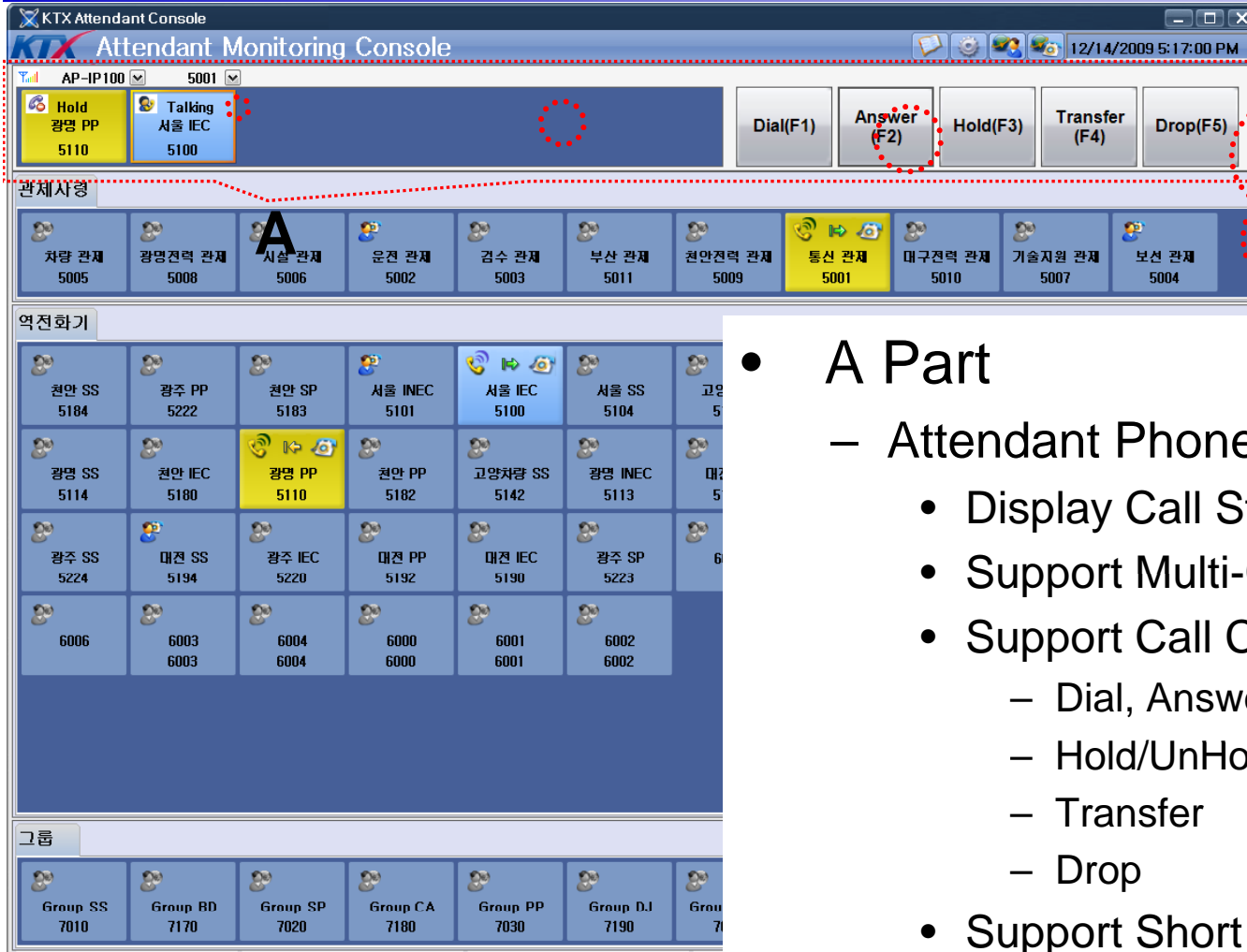

- A Part
 - Attendant Phone Call Control Part
 - Display Call Status
 - Support Multi-Call Display
 - Support Call Control Feature
 - Dial, Answer
 - Hold/UnHold
 - Transfer
 - Drop
 - Support Short Key Call Control

Touch Screen based Attendant Console Main Screen –Monitoring



• B Part

– Monitoring Group Part

- Support Various Group
 - Attendant and Direct Phone Group
 - Office Phone Group
- Support Group Management Feature
 - Add Group, Rename Group, Delete Group
 - Add User, Delete User
- Provide Various User Presence Status
 - » PC Online, PC-Phone Online, Phone Online
 - » Offline, Away, Absence
 - » Be in Conference, Call Busy
- Display Call Status



Touch Screen based Attendant Console Main Screen –Monitoring Group

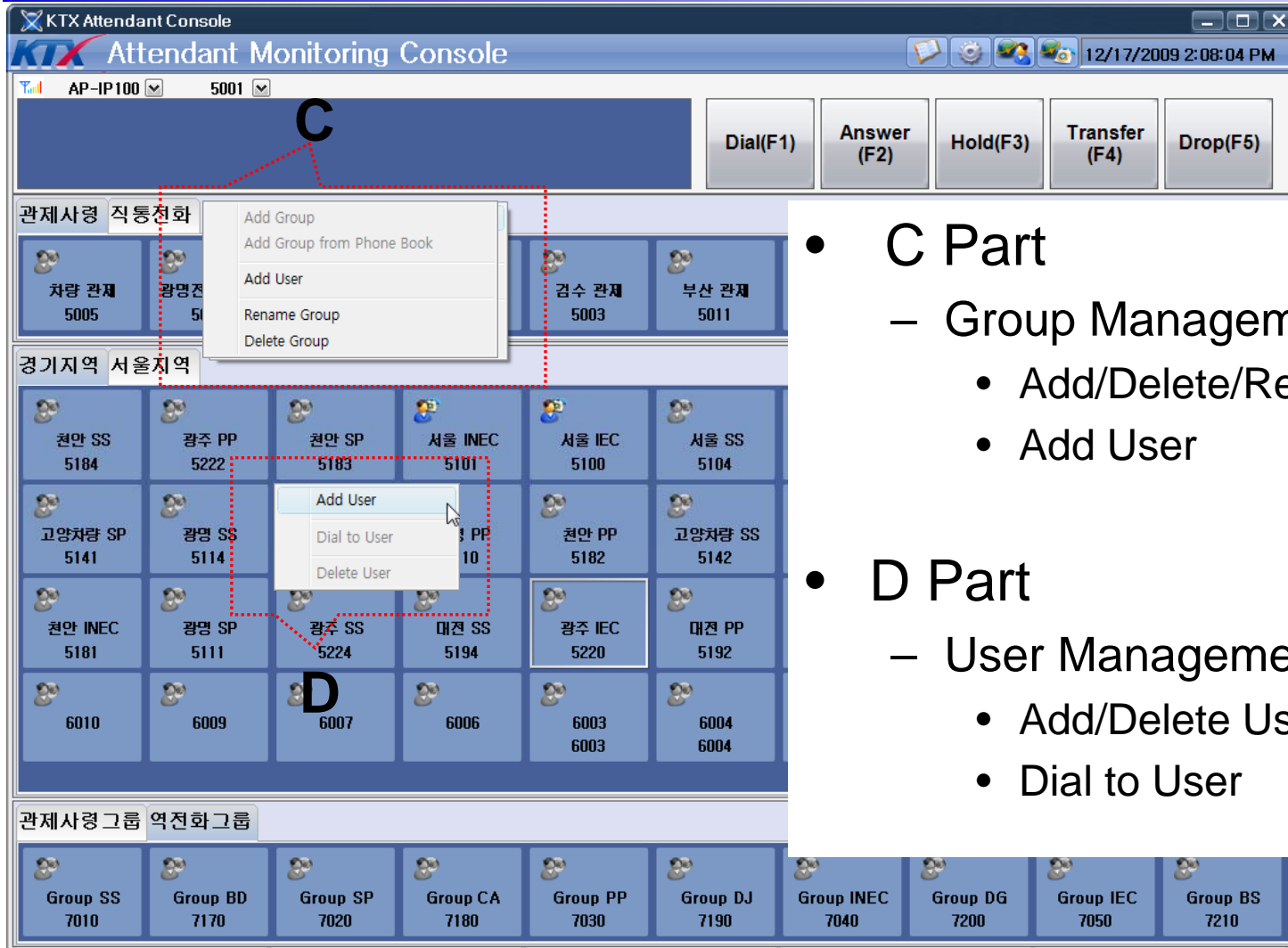

- C Part
 - Group Management Feature
 - Add/Delete/Rename Group
 - Add User

- D Part
 - User Management Feature
 - Add/Delete User
 - Dial to User

Touch Screen based Attendant Console Main Screen – Group Call

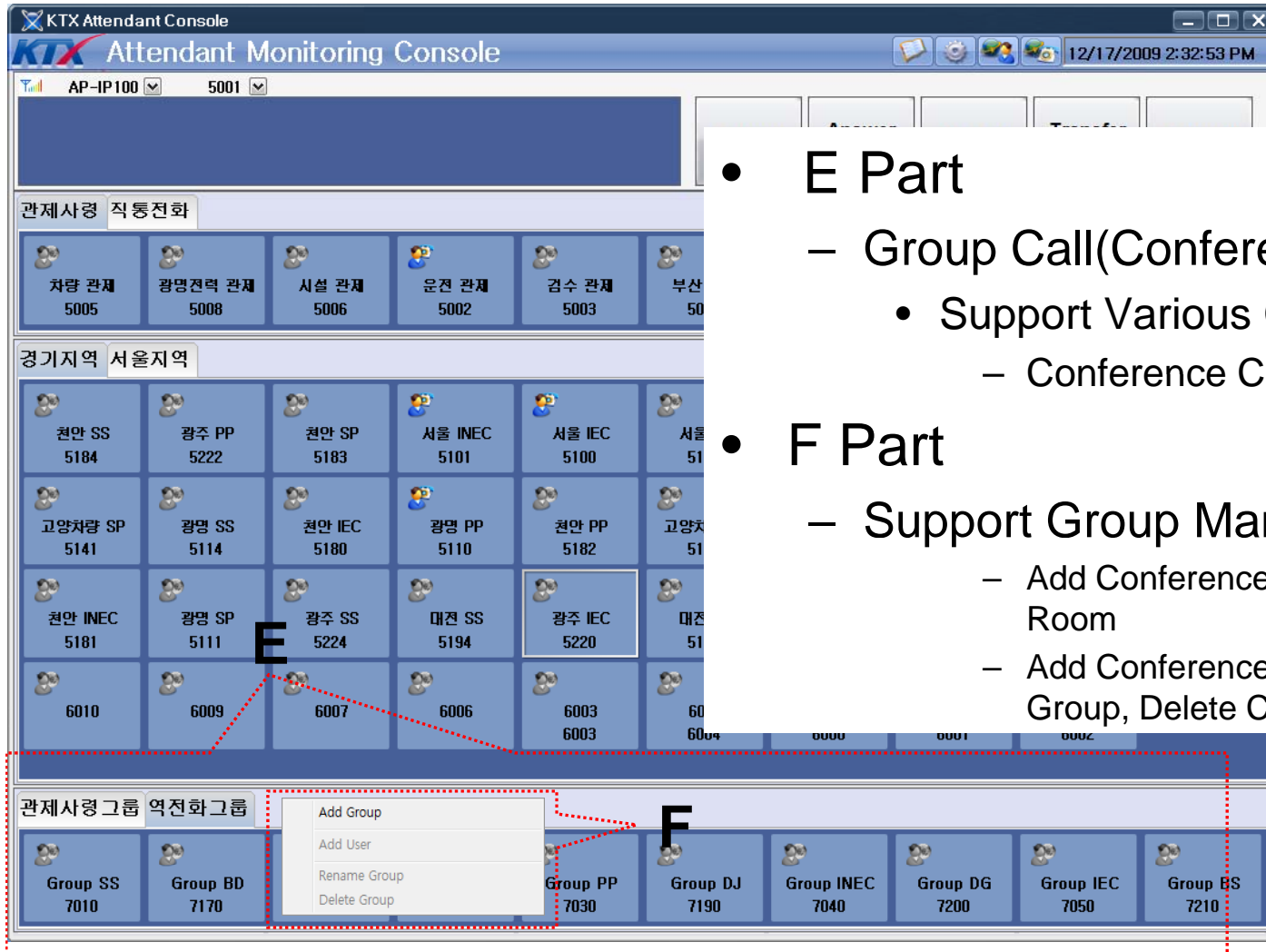

- E Part
 - Group Call(Conference) Part
 - Support Various Group
 - Conference Call Group
- F Part
 - Support Group Management Feature
 - Add Conference Room, Delete Conference Room
 - Add Conference Group, Rename Conference Group, Delete Conference Group



Smart NMS

Smart Network Management System

Main Features

- Web-based Management
- Network Resource Management
- Device Fault Management
- Device Fault History Management
- Device Status Information
- Notification Management
- Fault Statistics
- Model & Service Management

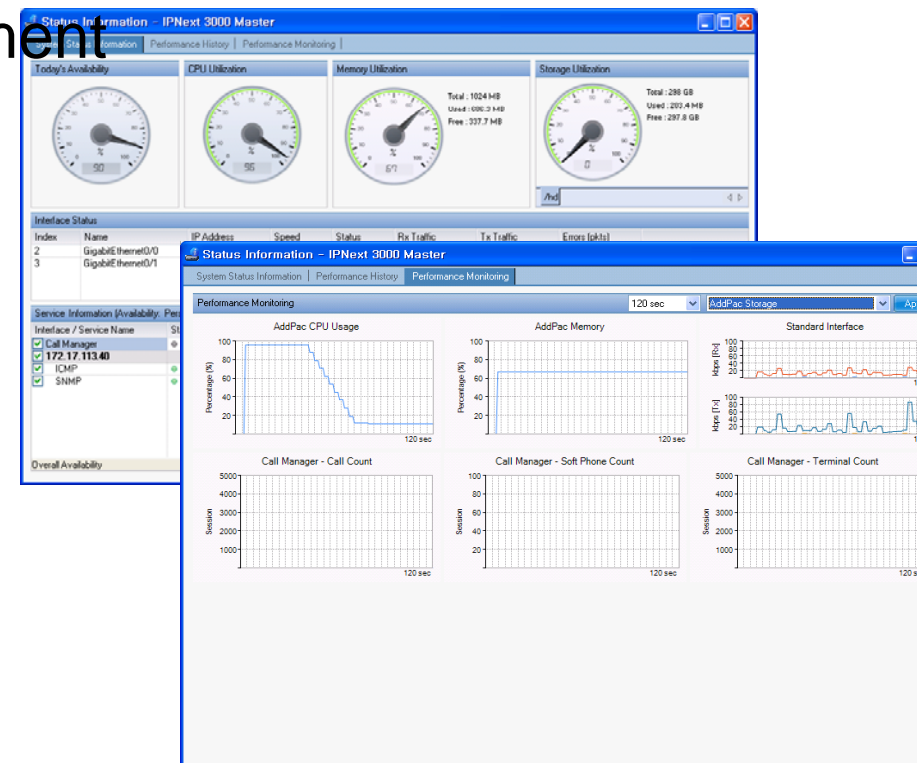



Thank you!

AddPac Technology Co., Ltd.
Sales and Marketing

Phone +82.2.568.3848 (KOREA)

FAX +82.2.568.3847 (KOREA)

E-mail sales@addpac.com