

# AP-VC2000™

## Video Conference Equipment

High Performance BcN Video Terminal Solution  
(BcN : Broadband Convergence Network)

### Video MCU Feature



**AddPac**

**AddPac Technology**

2006, Sales and Marketing

# Contents

AP-VC2000 MCU Video Phone

**AddPac**

- **Point-to-Point Communication Service**
- **AV Mixing Features for MCU Application**
  - Simplified AV Mixing Model
- **Conference Service Model**
- **Conference Service Type (H.323, SIP)**
  - Meet-Me (Dial-In) Conference
  - Ad Hoc (On-Demand) Conference
  - Dial Out Conference
- **View Mode Configuration**

# Point-to-Point Comm. Service

**AddPac**

## AP-VC2000 Video Conference Equipment

- **High-performance Video Codec Support**
  - H.263, MPEG-4, JPEG, and H.264
- **High-performance Audio Codec Support**
  - G.711, G.726, G.729, G.723.1, etc
- **Powerful Image Resolution Support**
  - QCIF(176x144), CIF(352x288), QVGA(320x240), and VGA(640x480)
- **Up to 30fps at 1Mbps with VGA-Resolution(MPEG-4)**
- **64Kbps to 2Mbps Operating Video Traffic Bandwidth**
- **Rate Control for Video Traffic QoS**
  - Ensuring Optimized Quality
  - Frame Rate with Limited Bandwidth
- **High-end Error Resilient Against Various Packet Error**
- **HD Display (720P, 480P)**

# AV Mixing Feature for MCU App.

**AddPac**

## Simplified Audio/Video Mixing Model

- **Single Video Codec : H.263 or MPEG4**
- **Voice Codec : G.711, G.726, etc**
- **Single Rate Control**
- **Asymmetric Rate Control between Encoder & Decoder**
- **Same Conference Layout for All Party**
- **HD Display (720P, 480P)**

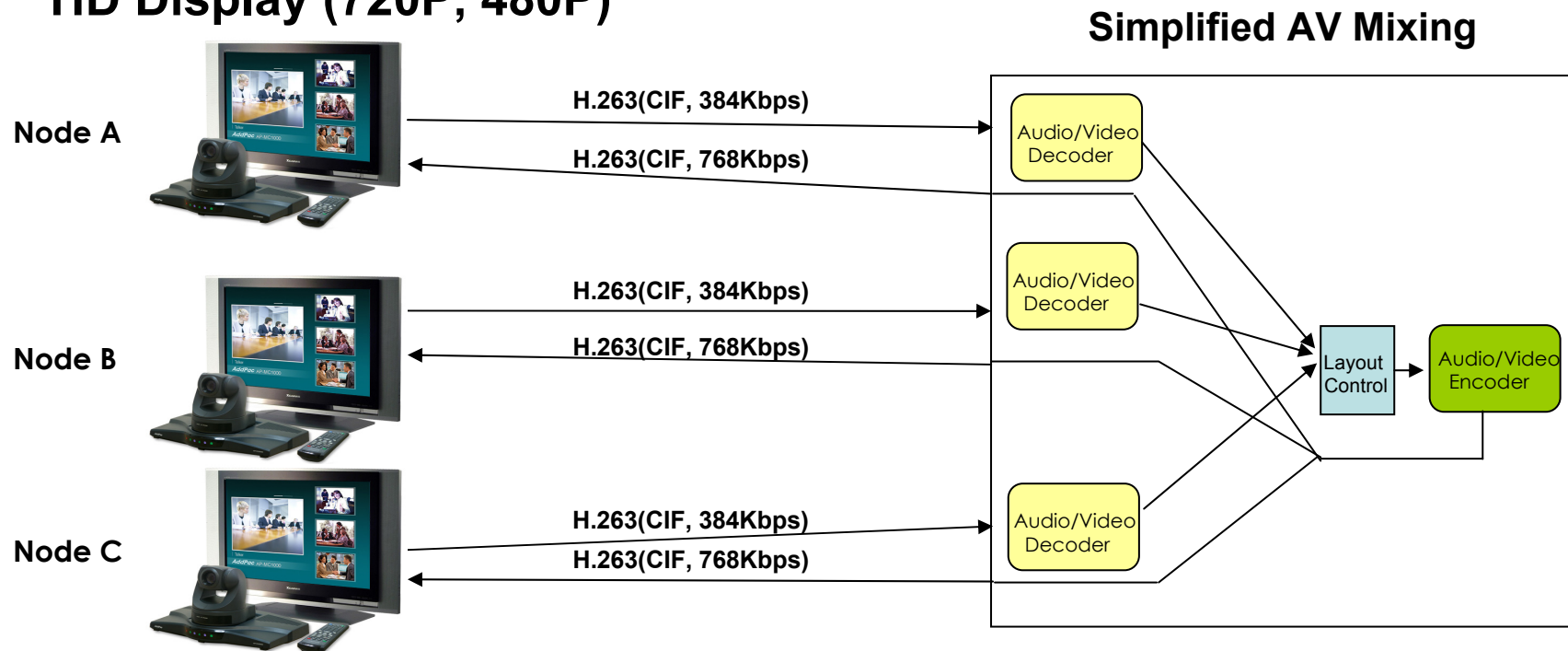

# Conference Service Model

AP-VC2000 Video Conference Equipment

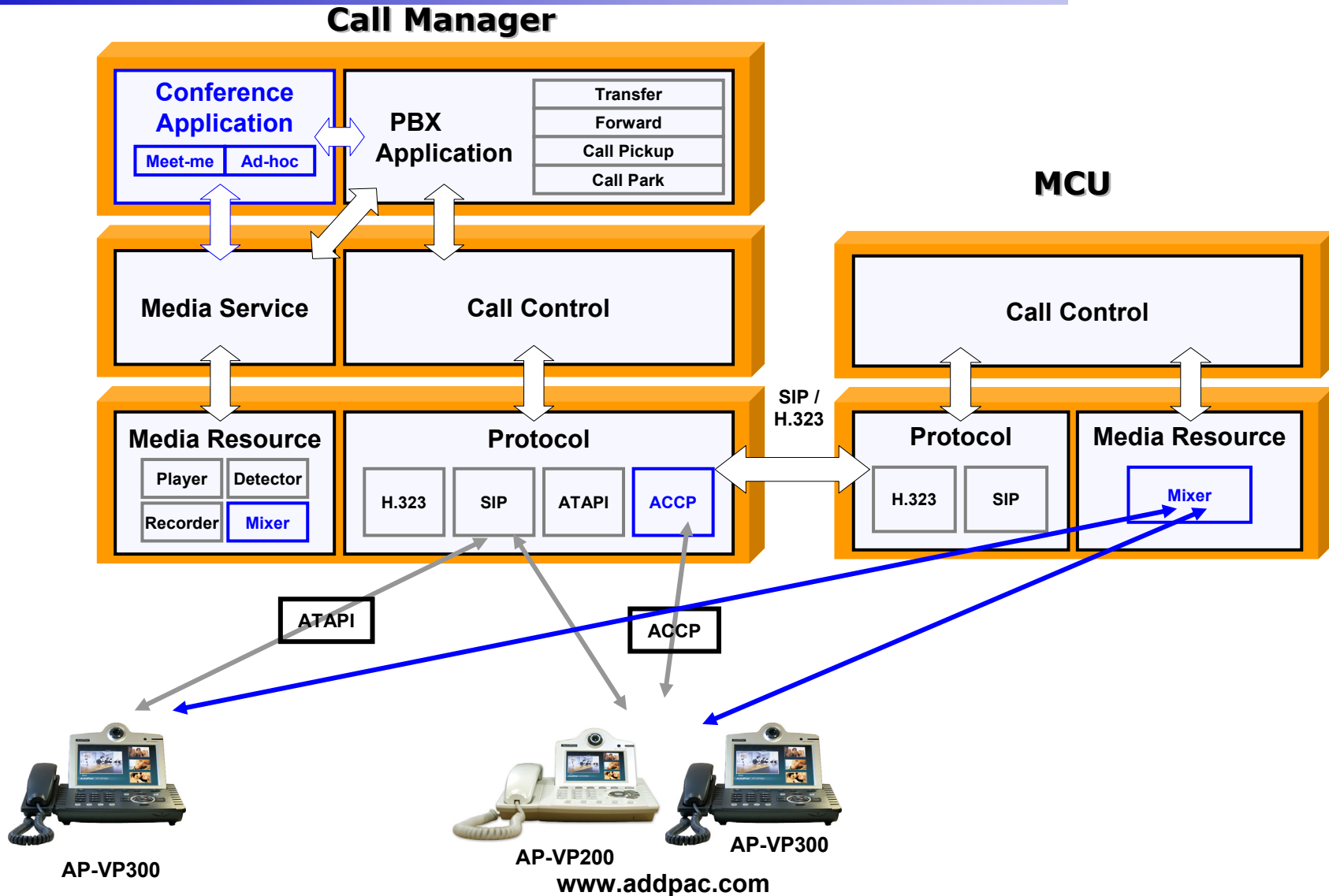

# Conference Service Model

AP-VC2000 Video Conference Equipment

**AddPac**

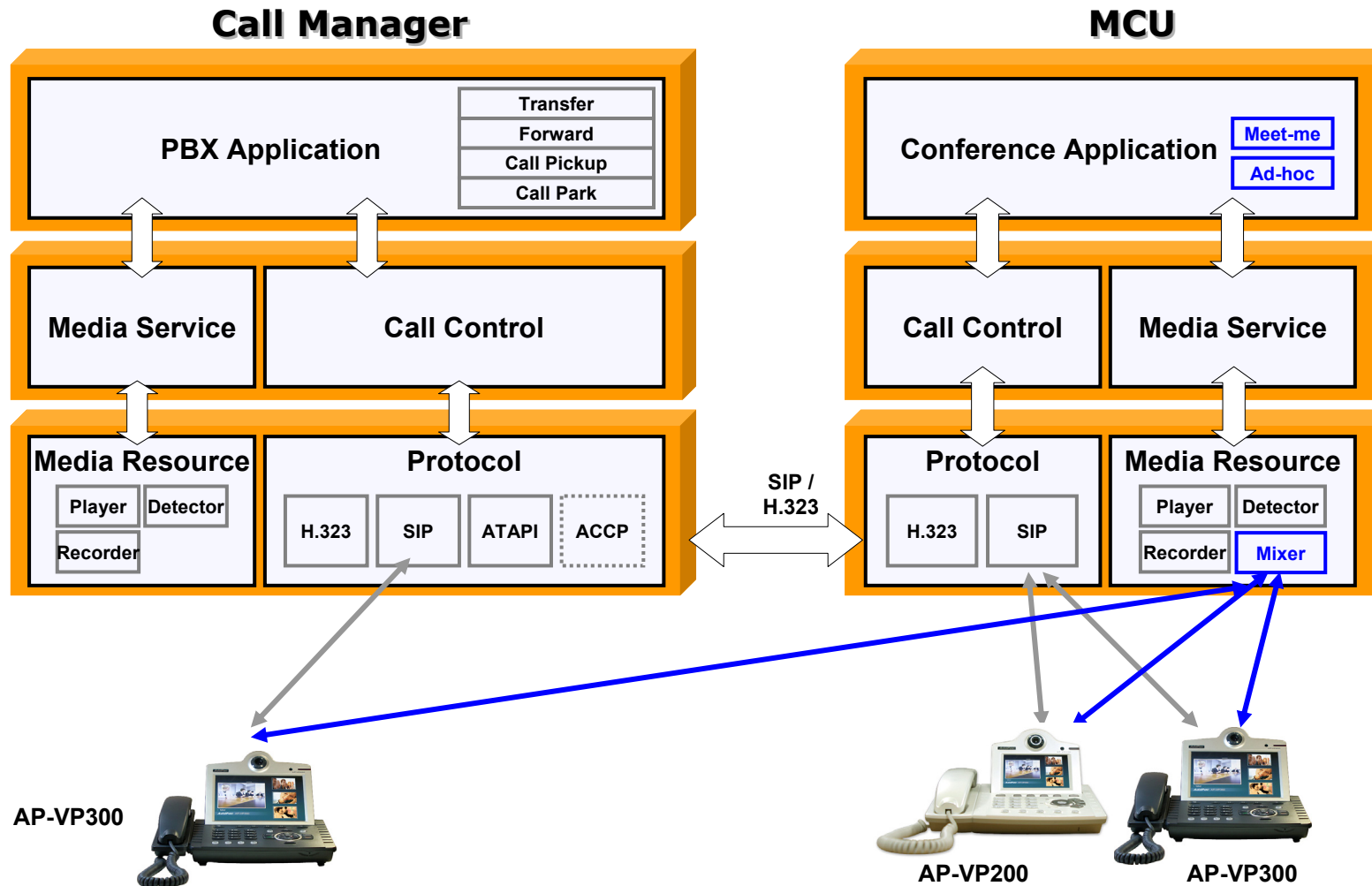

# Conference Service Type

AP-VC2000 Video Conference Equipment

**AddPac**

## Dial-Out Signaling

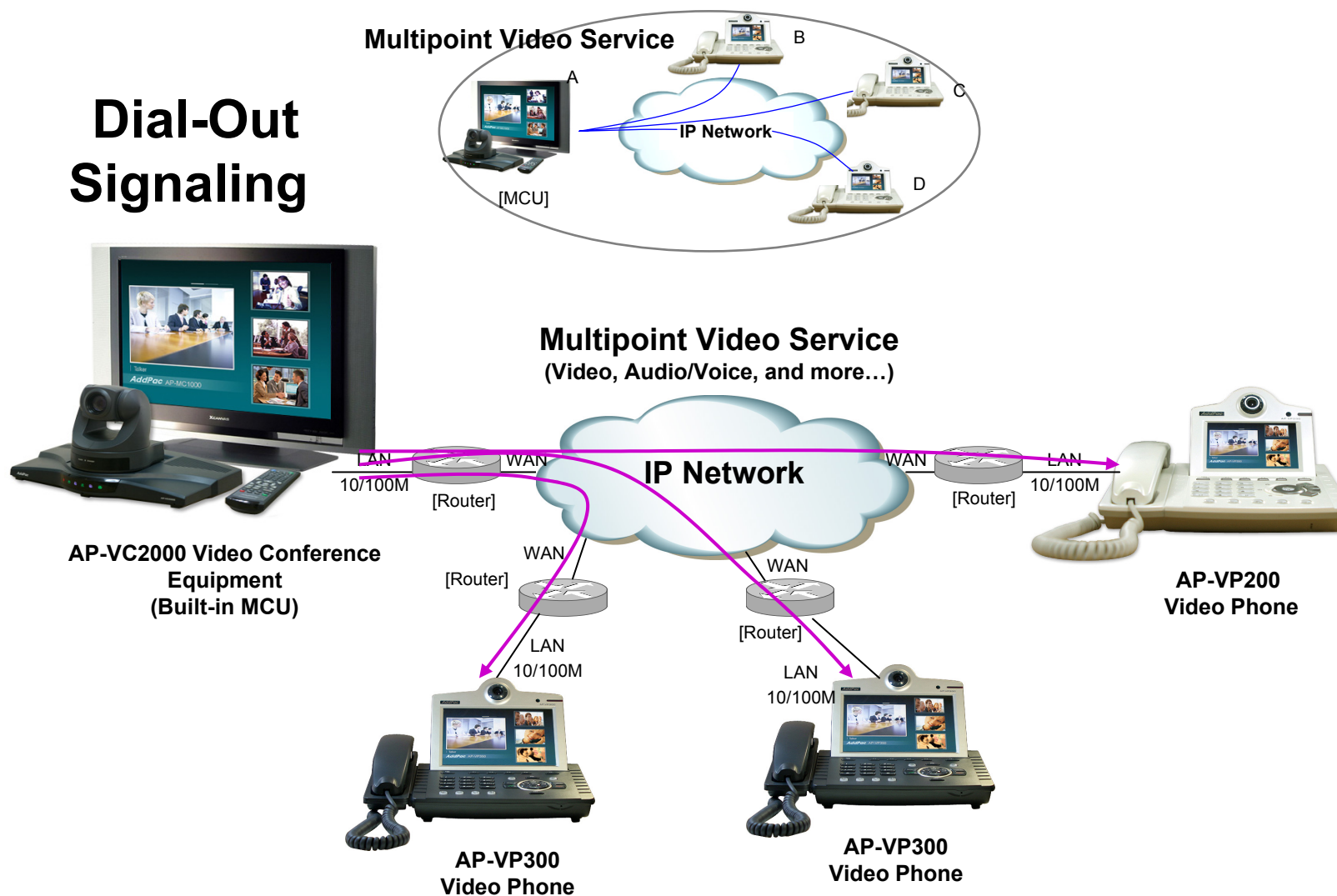

[www.addpac.com](http://www.addpac.com)

# Conference Service Type

AP-VC2000 Video Conference Equipment

**AddPac**

## Meet-Me Signaling

### Multipoint Video Service

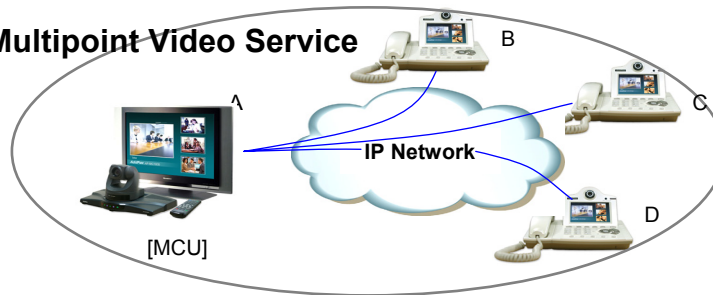

### Multipoint Video Service (Video, Audio/Voice, and more...)

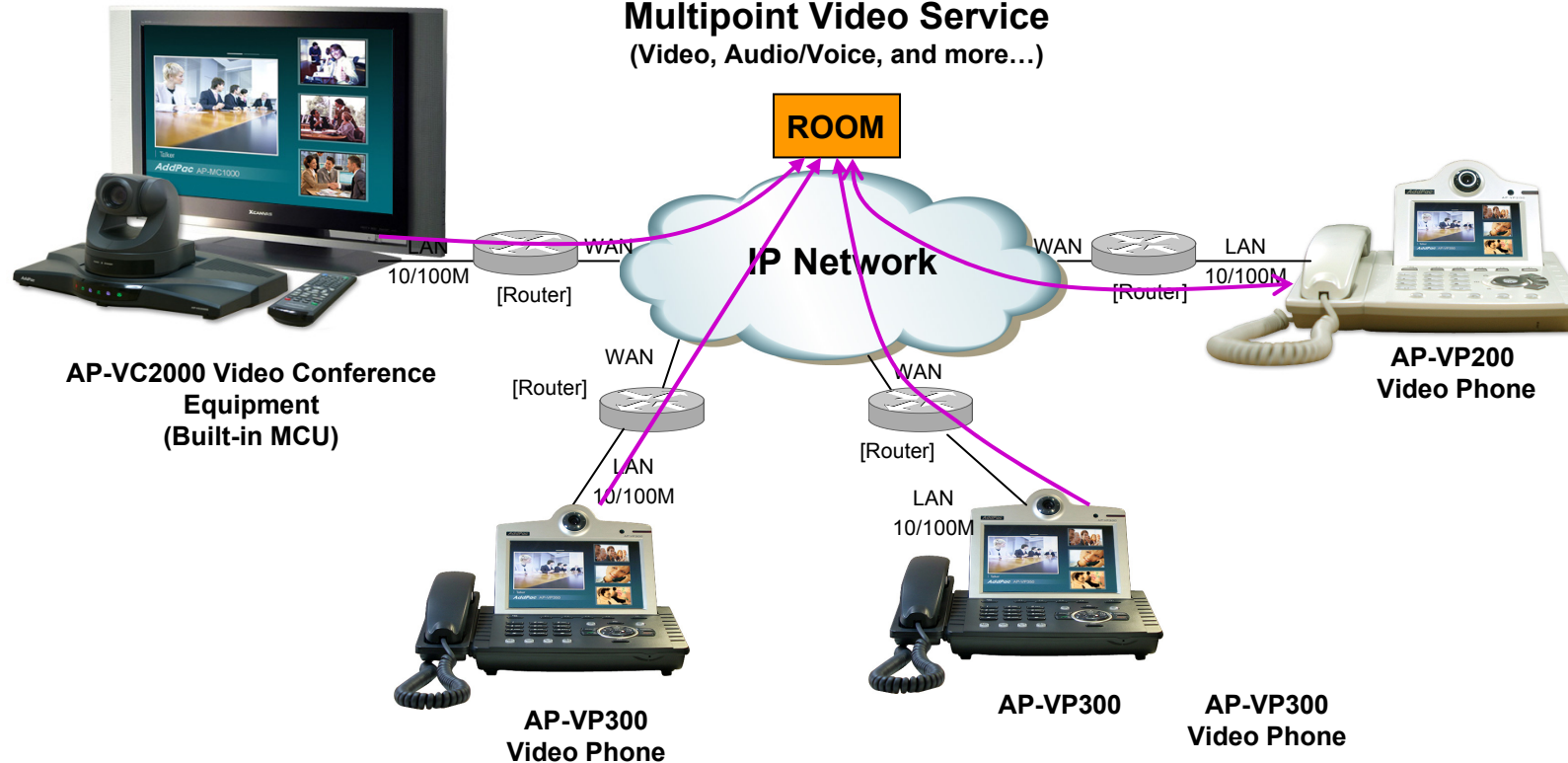

[www.addpac.com](http://www.addpac.com)



# Conference Service Type

AP-VC2000 Video Conference Equipment



## Add-Hoc Signaling

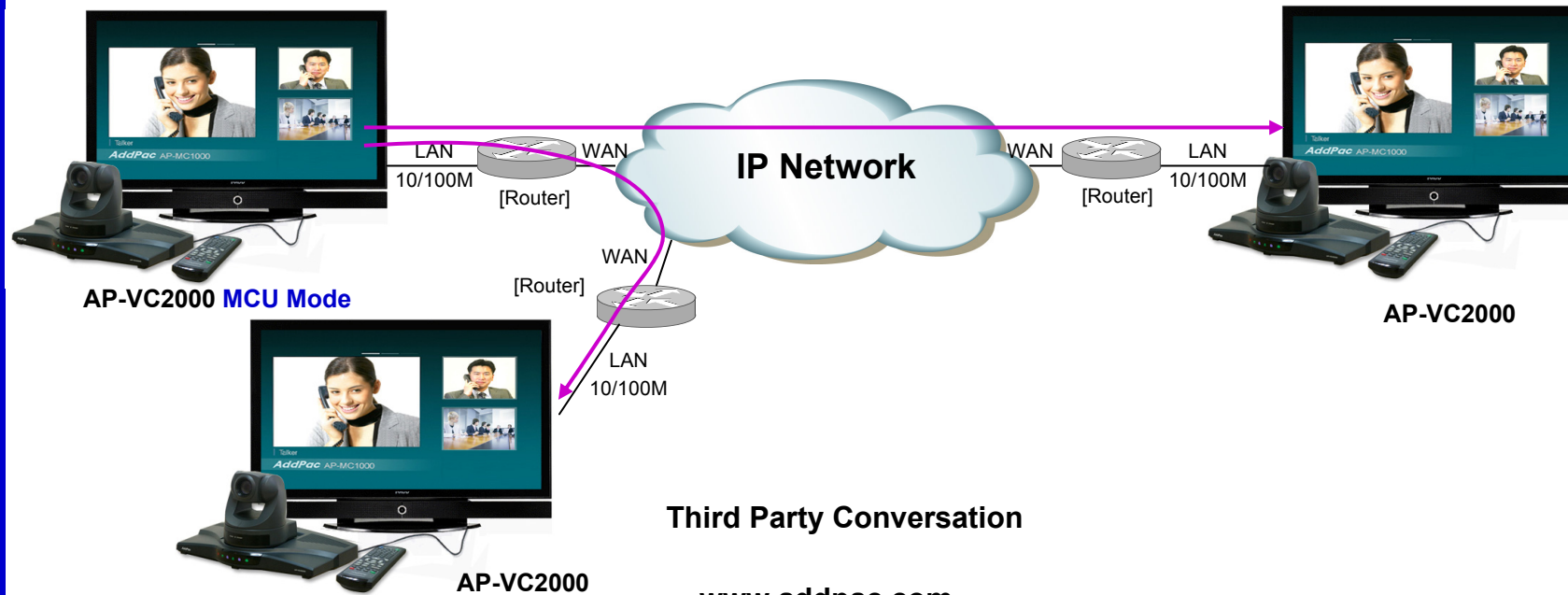
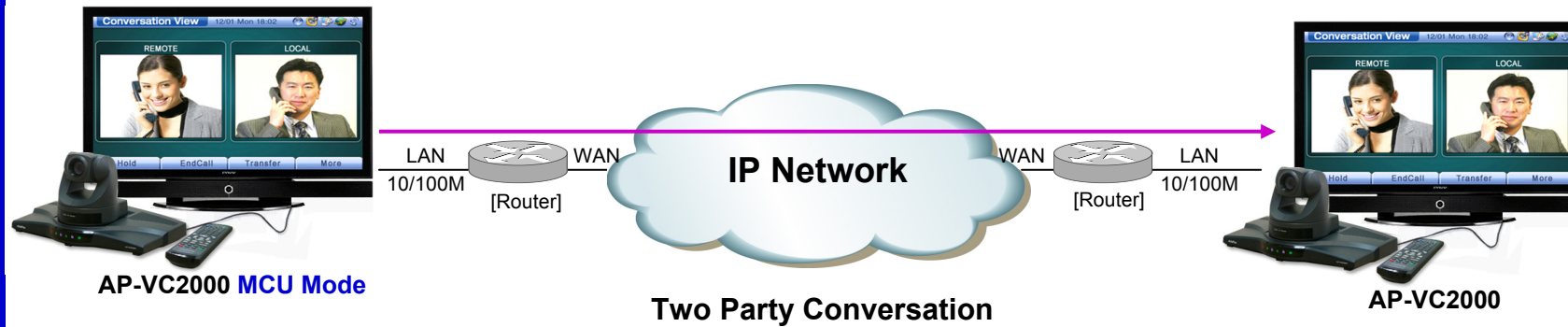

# Conference Service Type

AP-VC2000 Video Conference Equipment



## Add-Hoc Signaling

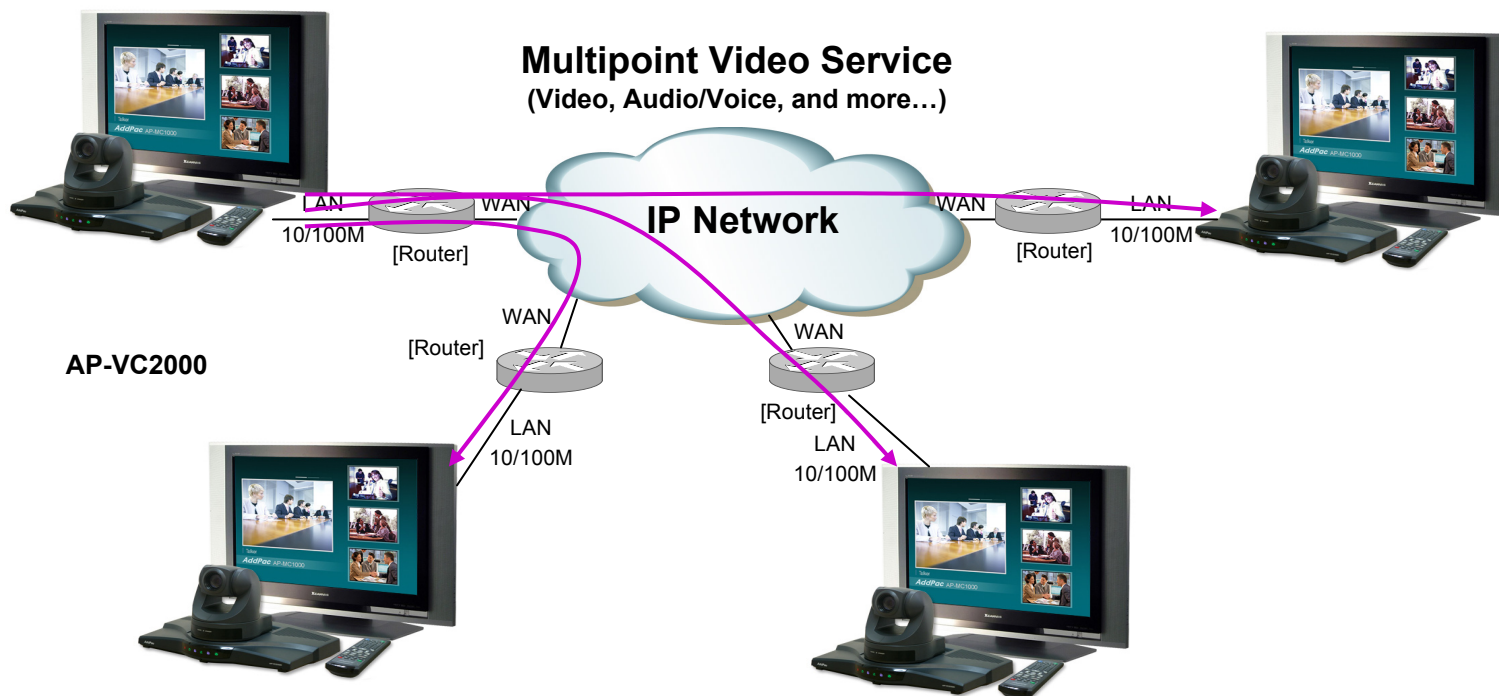

Four Party Conversation

# View Mode Configuration

AP-VC2000 Video Conference Equipment

**AddPac**



Thank you!

**AddPac Technology Co., Ltd.**  
Sales and Marketing

Phone +82.2.568.3848 (KOREA)

FAX +82.2.568.3847 (KOREA)

E-mail [sales@addpac.com](mailto:sales@addpac.com)