



# AP-MC3000

## IP Video MCU

High-performance Multipoint Video Mixing Solution



***AddPac***

**AddPac Technology**

Sales and Marketing

# Contents

- Product Overview
- Hardware Specification
- Software Service
- Video Service and Features
- Audio Service and Features
- Network Service and Features
- Conference Service and Features
- Application Area
- Ordering Information



# Product Overview

## AP-MC3000 Video MCU

- IP based Multipoint Audio/Video Mixing Solution
- Support Various Conference System Model
- Scalability and Flexibility
- High-performance Video, Audio, and Voice Service
- Firmware Upgradeable Architecture
- Video Solution with Outstanding Network Service Capability
- Audio/Video Privacy Protection

# Product Highlights

AP-MC3000 Video MCU

## IP based Multipoint Audio/Video Mixing Solution

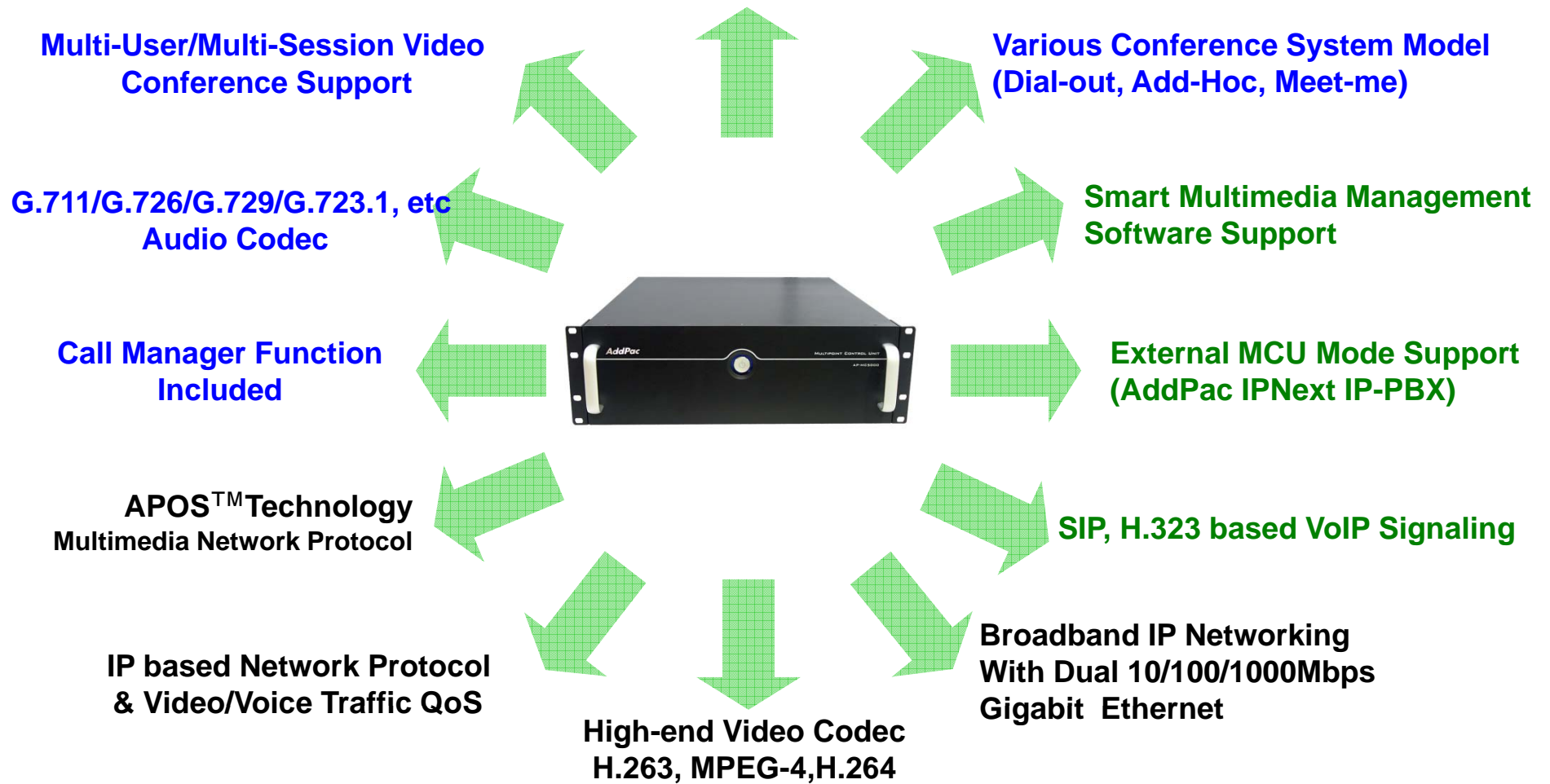

**AddPac**

[www.addpac.com](http://www.addpac.com)

# Hardware Specification

AP-MC3000 Video MCU

- **High Performance Computing Power**
- **Programmable Hardware Architecture**
- **Main Chassis**
  - **Network Interface**
    - Two(2) 10/100/1000Mbps Gigabit Ethernet
    - One(1) RS-232C Console (RJ45)



Power ON/OFF Switch

# Hardware Specification

AP-MC3000 Video MCU

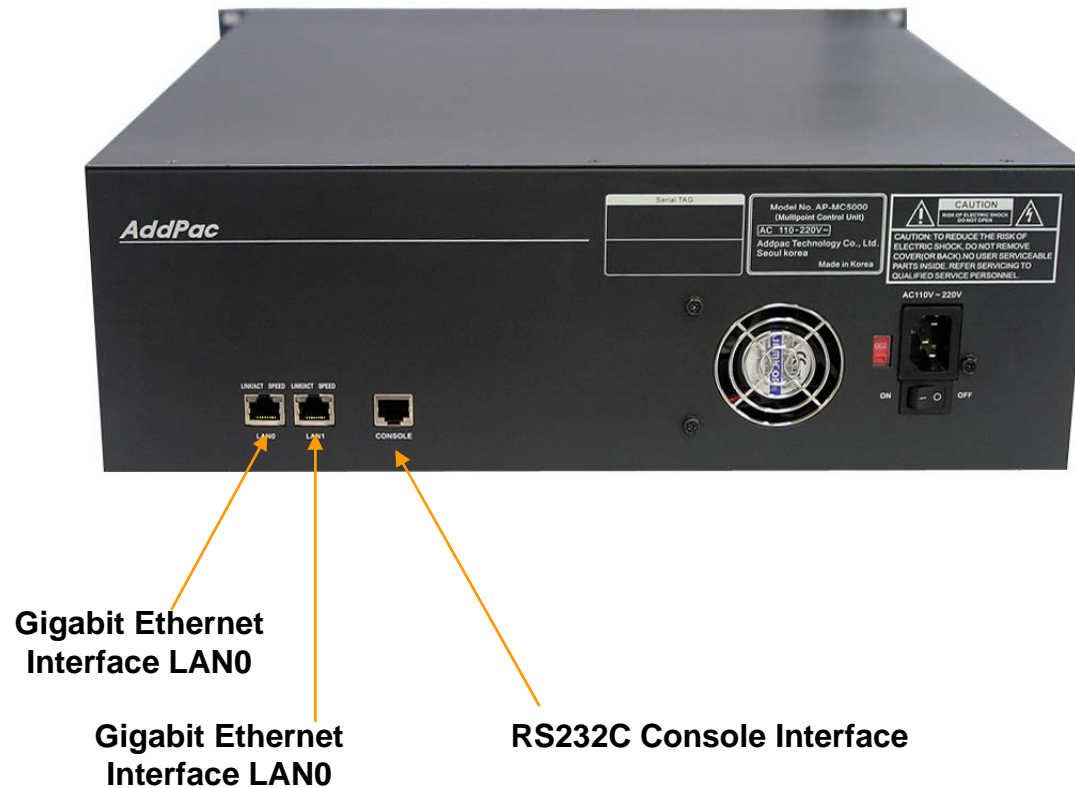

# Software Service

AP-MC3000 Video MCU

- **Built-in AddPac APOS Internetworking Software**
  - Scalability, Functionality, and Stability Features
  - Video Traffic QoS Control
- **Programmable Video, Audio, and Voice Services**
  - Video Codes, Audio, and Voice Codec
- **Firmware Upgradeable Architecture**
- **Function Support**
- **Industry Standard IP based Network Protocol Features**
- **SMM (Smart Multimedia Manager) Solution**
  - Server and Client Architecture
  - Intel Pentium Machine with MS Window Server OS and MS-SQL

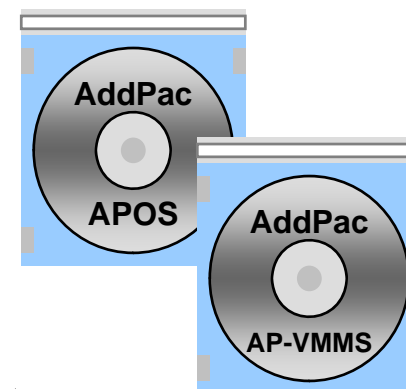

# Video Service and Features

AP-MC3000 Video MCU

- **High-performance Video Codec Support**
  - H.263, MPEG-4, H.264
- **Powerful Image Resolution Support**
  - QCIF(176x144), CIF(352x288), QVGA(320x240), and VGA(640x480), HD(1280x720), Full HD (1920x1080)
- **Up to 30fps with Full HD -Resolution(H.264)**
- **256Kbps to 15Mbps Operating Video Traffic Bandwidth**
- **Rate Control for Video Traffic QoS**
  - Ensuring Optimized Quality
  - Frame Rate with Limited Bandwidth
- **High-end Error Resilient Against Various Packet Error**



# Audio & Voice Service and Features

AP-MC3000 Video MCU

- **VoIP based Signaling Protocol Support**
  - SIP, H.323 based Signaling Protocol Stack
- **High-performance Audio & Voice Codec Support**
  - G.729.1, G.723.1, G.726, G.711, G.722, etc Audio Codec
- **Enhanced QoS Management Features for Voice Traffics**

# Network Service and Features (cont..)

AP-MC3000 Video MCU

- **Network Managements**
  - SNMPv2/SNMPv3 Support
  - Standard & Enterprise SNMP MIB Support
  - Web Based Management using HTTP/HTTPS
  - Console / Telnet / Rlogin / SSH Interface
- **Security Functions**
  - Standard & Extended IP Access List
  - HTTPS / SSH Interface
  - Auto-disconnect Telnet/Console Session
  - Access Control for Local Service (FTP/Telnet/HTTP.)
  - Enable/Disable Network Services
  - Multi-Level User Account Management

# Network Service and Features

AP-MC3000 Video MCU

- **Operation & Managements**

- Configuration Backup & Restore for APOS Managements
- Use Multiple APOS™ and Configuration
- Auto Upgrade via HTTP/HTTPS
- Debugging, System Auditing, and Diagnostics Support
- FTP/TFTP/Telnet/SSH Server and Client
- HTTP Server
- RADIUS Authentication / Account

- **Other Scalability Features**

- Network time Protocol(NTP) Support
- Cisco Style Command Line Interface (CLI)
- DHCP Server & Relay Functions
- DNS Server

# Conference Service and Features (cont..)

AP-MC3000 Video MCU

- Type of Conference
  - Meet-Me (Dial-In) Conference
    - Require that a *range of directory numbers* be allocated for exclusive use of the conference
  - Ad Hoc (On-Demand) Conference
    - using Conference and Join soft key
  - Scheduled Conference
    - Through compatible third-party scheduling applications
- View Mode Configuration

# Conference Service and Features (cont..)

AP-MC3000 Video MCU

## Conference System Model

### Call Manager controlled conference

(1)



MCU Integrated

(2)

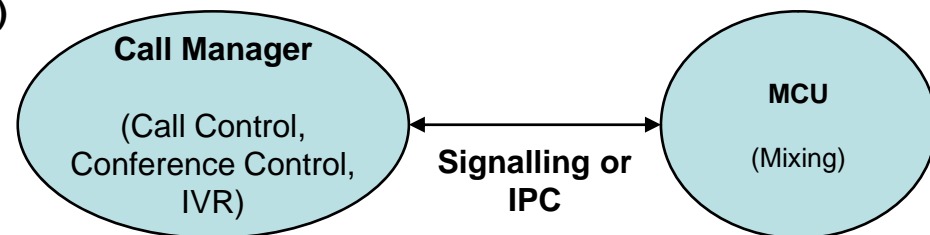

Using MCU as a Resource

### Interoperate with Stand-alone MCU

(3)

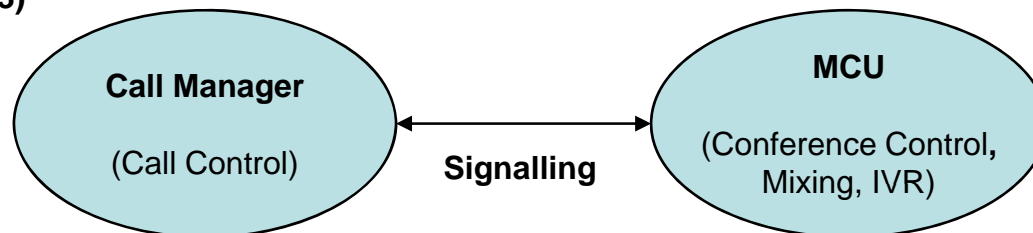

# Conference Service and Features (cont..)

AP-MC3000 Video MCU

## Call Manager + MCU

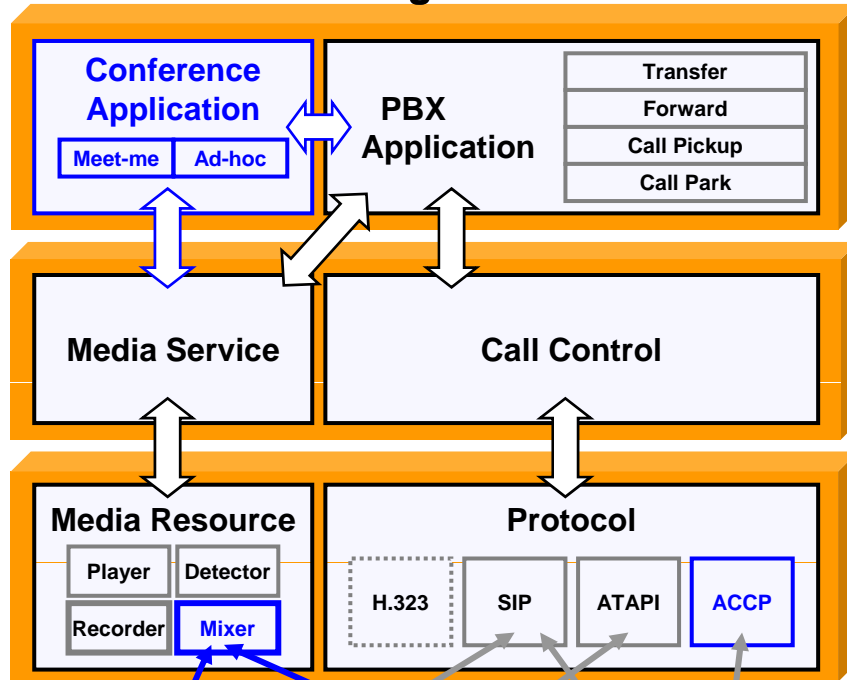

## MCU Integrated Model

\* ATAPI - AddPac Telephony API  
 \* ACCP - AddPac Client Control Protocol

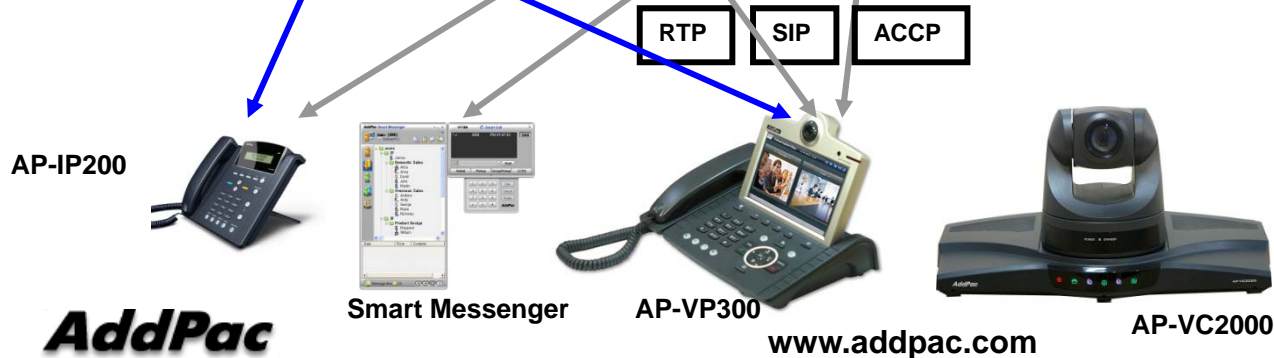

**AddPac**

Smart Messenger

AP-VP300

[www.addpac.com](http://www.addpac.com)

AP-VC2000

# Conference Service and Features (cont..)

AP-MC3000 Video MCU

## Call Manager

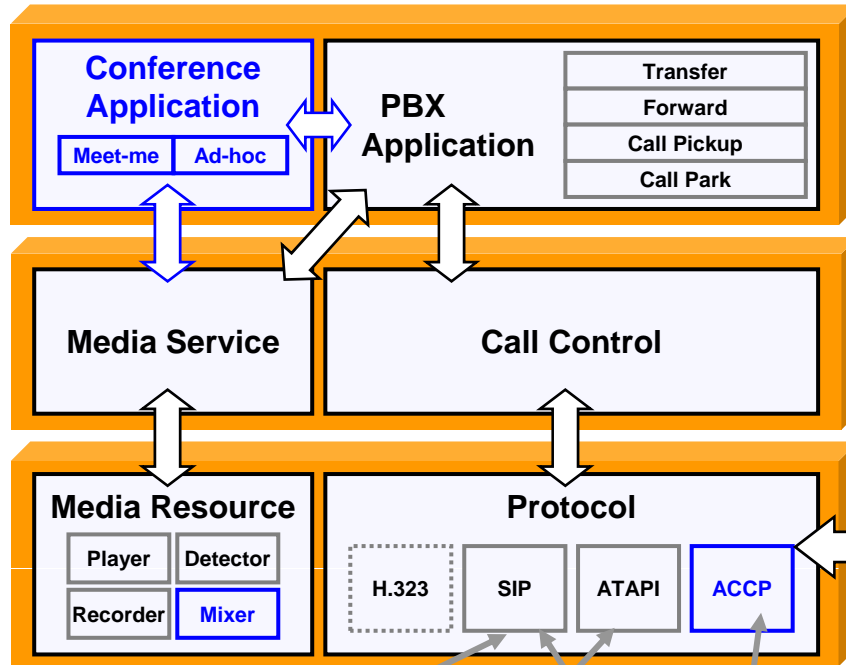

## Using MCU as a Resource

### MCU

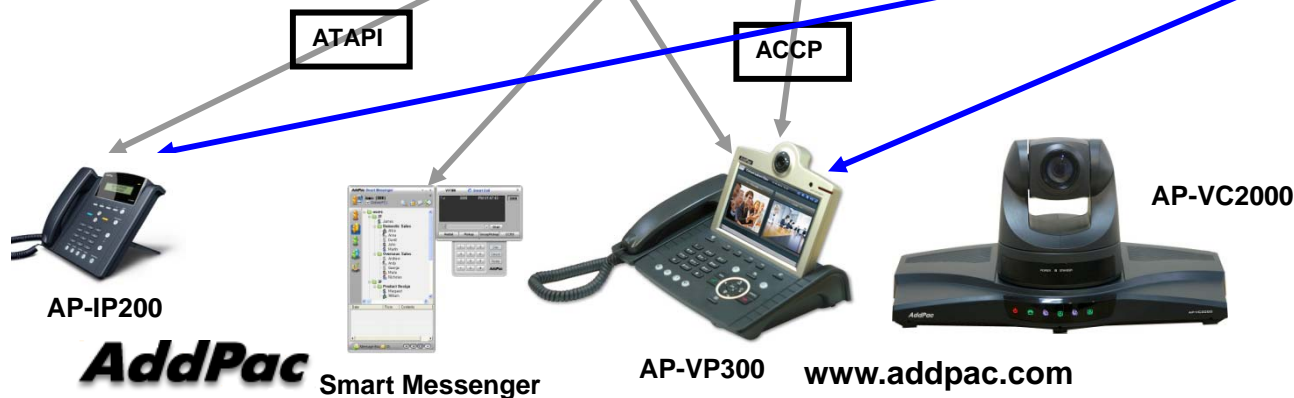
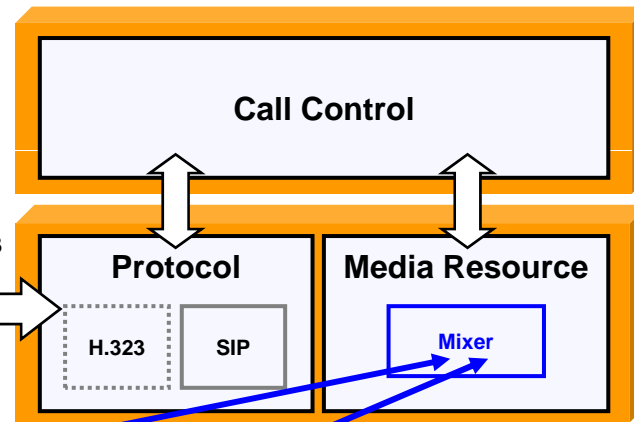

**AddPac**

Smart Messenger

AP-VP300

[www.addpac.com](http://www.addpac.com)

# Conference Service and Features

AP-MC3000 Video MCU

## Stand-alone MCU Model

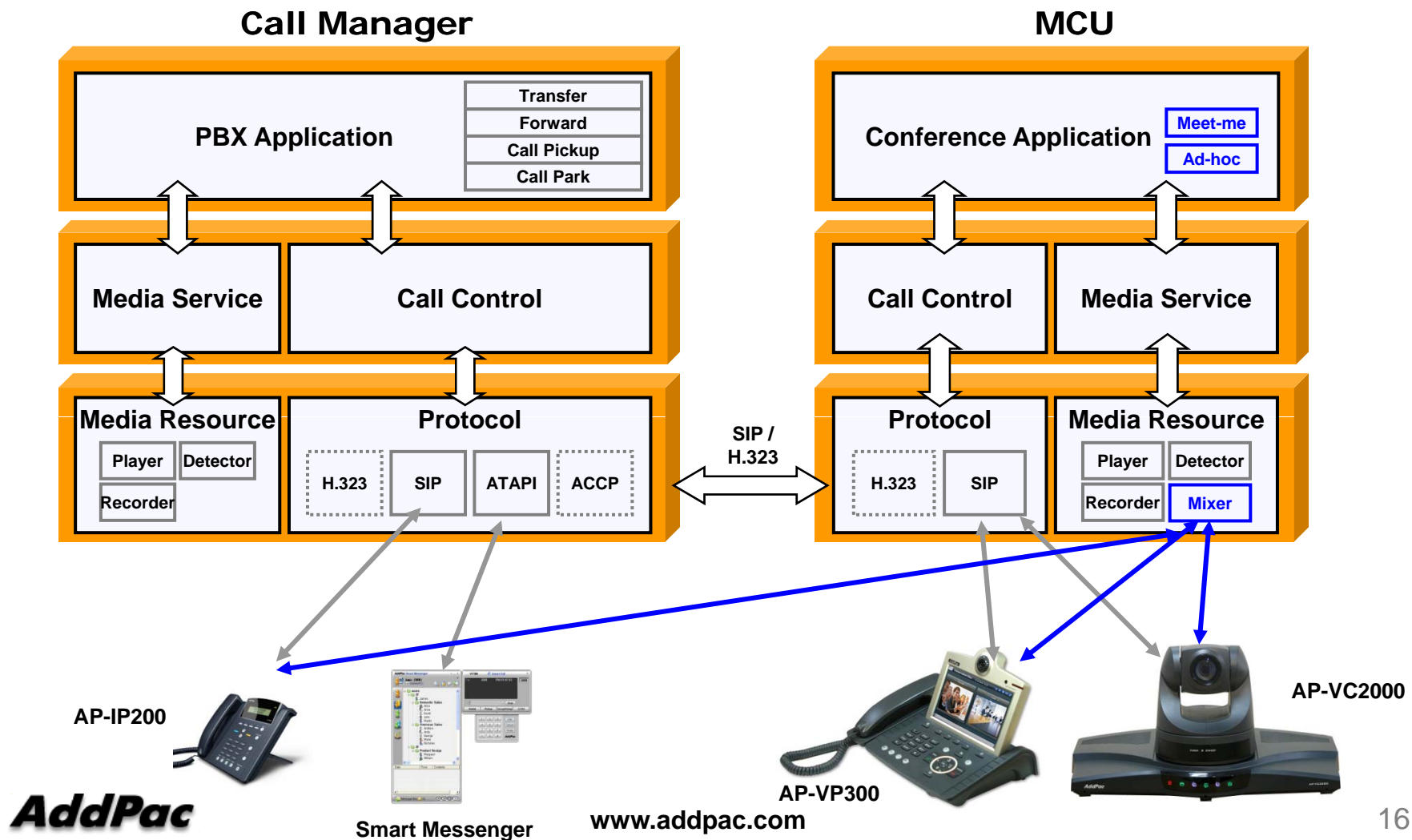



# AP-MC3000 Video MCU

## Network Diagram for Video Conference

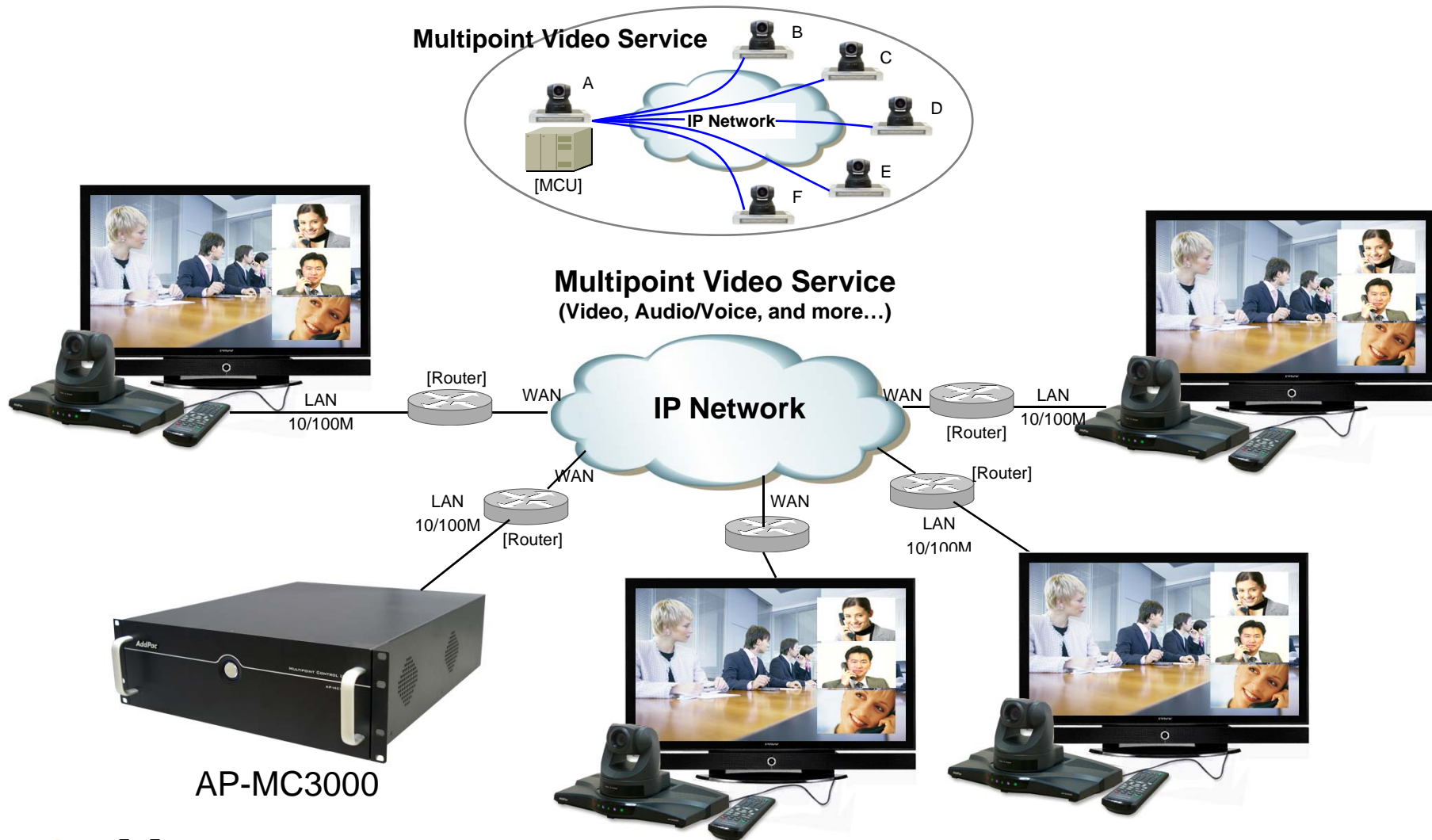

AP-MC3000

**AddPac**

[www.addpac.com](http://www.addpac.com)

# Ordering Information

- **AP-MC3000 Video MCU Hardware**
  - AP-MC3000 Video MCU Main Body
  - 2-port 10/100/1000Mbps Gigabit Ethernet and 1-port RS-232C Console(RJ45)
  - Including Network Cable Set
- **Built-in APOS Internetworking Software for AP-MC3000**
- **Including 1 Year Hardware Warranty**
- **Product Documents**
  - Install and Operation Guide (PDF)
- **Pricing**
  - AddPac Technology Regional Sales Manager
  - Authorized Sales and Marketing Representatives
  - Please Contact [www.addpac.com](http://www.addpac.com)



# Thank you!

**AddPac Technology Co., Ltd.**  
Sales and Marketing

Phone +82.2.568.3848 (KOREA)

FAX +82.2.568.3847 (KOREA)

E-mail [sales@addpac.com](mailto:sales@addpac.com)