

Hot-Swap Function for AP1800, AP2330, AP2340 VoIP Modules



AddPac

AddPac Technology

2011, Sales and Marketing

Contents



- AP1800, AP2330, AP2340, etc N1 Platform
- Hot-Swap VoIP Modules for N1 Platform
- Hot-Swap Function Overview
- System Architecture for Hot-Swap Service
- Example : AP2330 VoIP Module Exchange





AP1800, AP2330, AP2340 N1 Platform

AP1800, AP2330, AP2340 N1 Platform

	AP1800	AP2330	AP2340
Model			
Module Slot	2 Module Slot	3 Module Slots	4 Module Slots
Media Gateway Service Module	Digital E1/T1, 8-Port FXS, 8-Port FXO, 4-Port FXS/4-Port FXO, 4-Port E&M	8-Port FXS, 8-Port FXO, 4-Port FXS/4-Port FXO, 4-Port E&M	8-Port FXS, 8-Port FXO, 4-Port FXS/4-Port FXO, 4-Port E&M
Power Supply	Internal Power Module (AC)	Internal Power Module (AC)	Internal Power Module (AC)
Power Type	Built-In	Built-In	Built-In



VoIP Modules for N1 Platform

N1 Platform VoIP Modules

High-end
DSP

AP-N1-FXS8

8-Port FXS Voice Processing Module (8 x RJ11)



AP-N1-FXO8

8-Port FXO Voice Processing Module (8 x RJ11)



AP-N1-FXO4S4

4-Port FXO and 4-Port FXS Voice Processing Module (8 x RJ11)

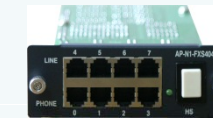

AP-N1-E1T1

1-Port VoIP Digital E1/T1 Interface Module(1xRJ45)



AP-N1-2E1T1

2-Port VoIP Digital E1/T1 Interface Module(1xRJ45)



N1 Platform VoIP Modules

High-end
DSP

AP-N1-E&M4

4-Port E&M Voice Processing Module (4 x RJ45)



Hot-Swap Function Overview

High-end
DSP

- Hot-Swap Function

- To insert/delete a new VoIP module while in-service state.
- Support push button switch for a VoIP module Hot-Swap
- Support status check LED

Example : AP1800 VoIP Gateway

Back Side



Hot-Swap Status LED

Push Button Switch for Hot-Swap

System Architecture for Hot-Swap Function



Hot-Swap Procedure

1. Hot-Swap LED ON
2. Push Hot-Swap Button
3. CPU Hot-Swap Register Polling
4. Bit High -> Low
5. Terminate Card Program
6. Hot-Swap LED OFF

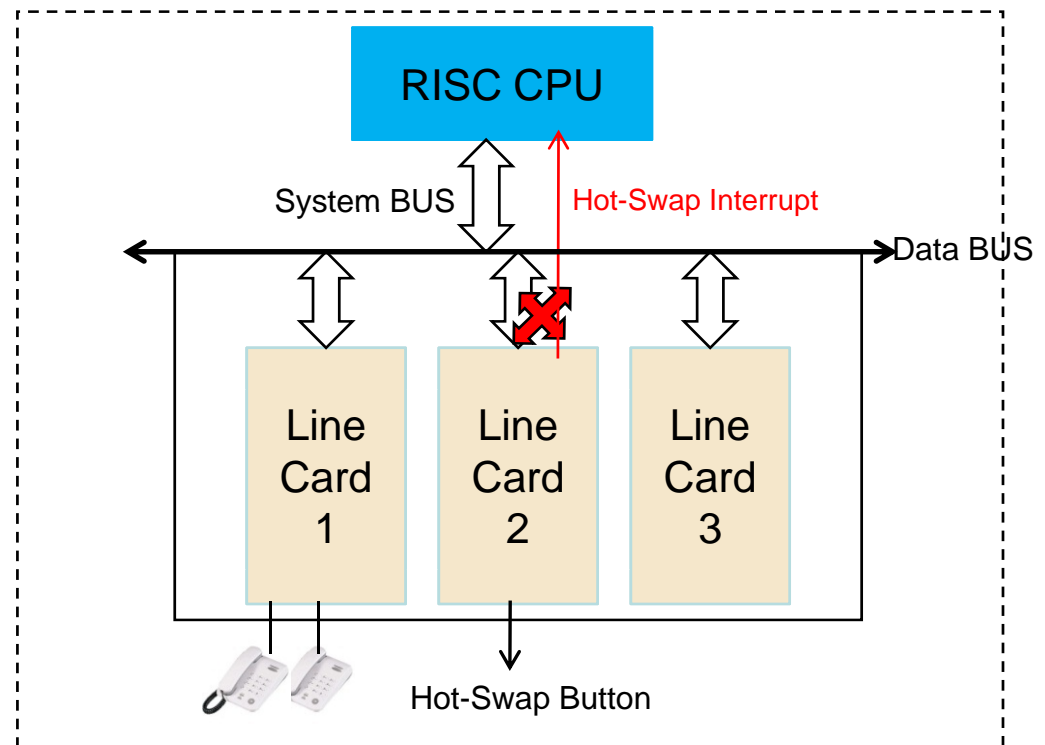
AddPac N1 Platform VoIP Gateway



Example : AP2330 VoIP Module Exchange

1		<p><Push Hot-Swap Button> Press Hot-Swap button for 3 seconds. LED will be turned off to remove the module.</p>
2		<p><Eject Module> Check the status of LED OFF. You may remove the module from VoIP Gateway safely.</p>
3		<p><Insert Module> You may install the module in VoIP gateway safely.</p>

VoIP Gateway Series

Thank you!

AddPac Technology Co., Ltd.
Sales and Marketing

Phone +82.2.568.3848 (KOREA)

FAX +82.2.568.3847 (KOREA)

E-mail sales@addpac.com