

BLF(Busy Lamp Field) Function



AddPac

AddPac Technology

2011, Sales and Marketing

Contents

- BLF Service Diagram
- BLF IP Phone Example
- BLF Protocols
- BLF Message Flow Example
- BLF Service IP Phone Comparison Table
- BLF Service IP Video Phone Comparison Table
- BLF IP Phones

BLF Service Diagram

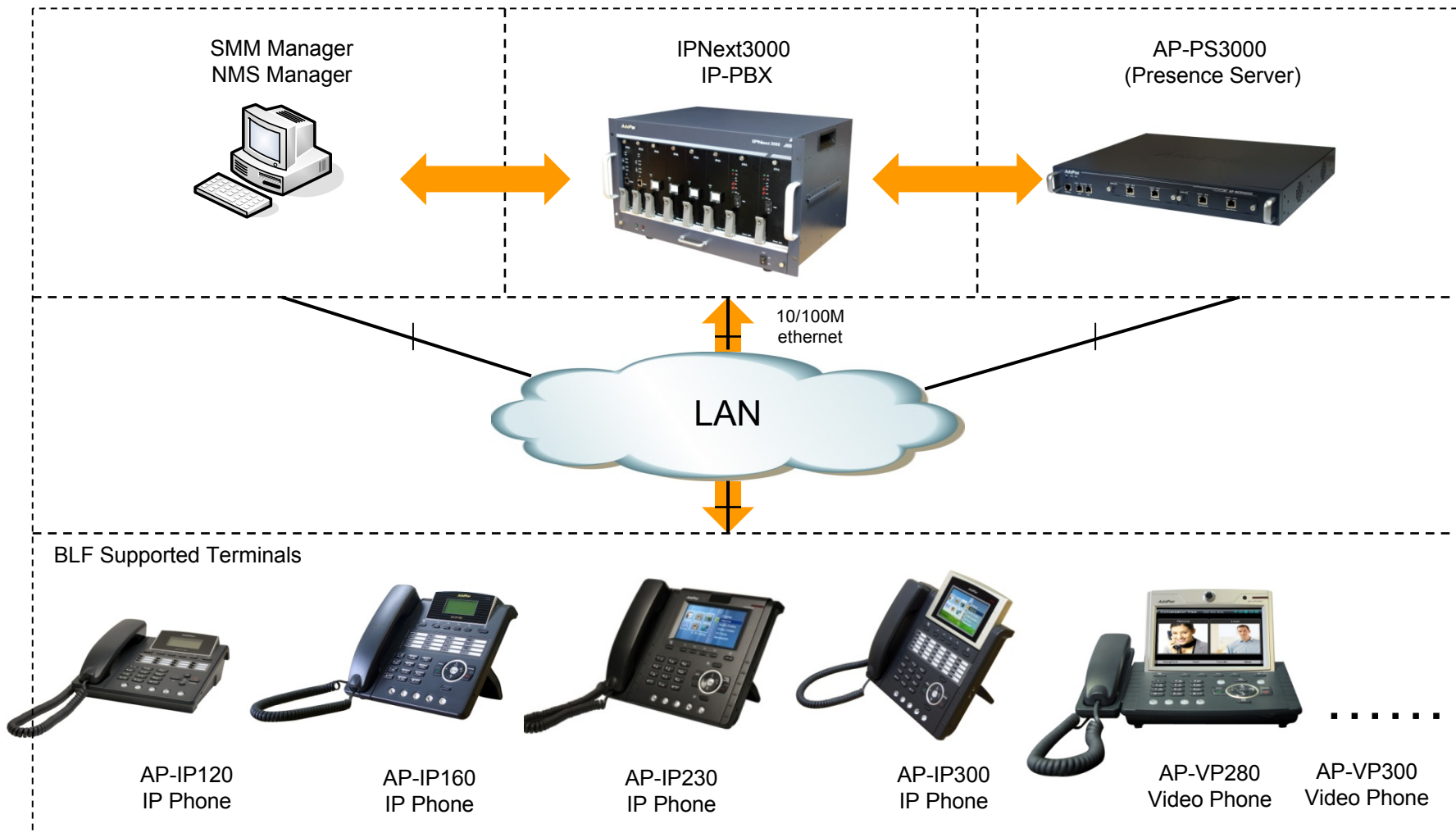

BLF IP-Phone Example (1/2)



BLF IP-Phone Example (2/2)

- **BLF (Busy Lamp Field)**

The Busy Lamp Field (BLF) feature allows you to program a key that monitors whether or not another user is on a call.

The BLF Key also acts as a Speed Dial key to the monitored user's number, and as a Call Pickup key on behalf of the monitored user.

The appearance of the LED indicator for the BLF key is as follows:

Line Status	BLF Indicator	Description
Idle (On hook)	Off	The user being monitored is not on a call, nor dialing a call. The BLF key can be used as a speed dial key to the monitored user.
Off hook/Outgoing call	Solid Red	The monitored user is in the process of placing a call. The BLF key can be used as a speed dial key to the monitored user.
Incoming call	Flashing Red	A call is incoming for the monitored user. Press the BLF key to pick up the call on behalf of the monitored user.
Connected call	Solid Red	The incoming call has been answered by the monitored user. The BLF key can be used as a speed dial key to the monitored user.

BLF Protocols

- **RFC 4235 – Dialog Event Package**

RFC 4235 defines the mechanism for an endpoint to subscribe to the state of any dialog involving another endpoint. RFC 4235 is an instantiation of the SIP Specific Event Notification Framework (RFC 3265) and defines the dialog event package. It also defines the behavior of the device (subscriber) and the Application Server in the context of subscriptions to the dialog event package.

- **RFC 4662– Resource Lists**

RFC 4662 defines an aggregating mechanism that allows for subscribing and notifying for a list of resources. This is useful in the context of the Attendant Console application whether the device needs to subscribe to a large number of resources.

- **Compatibility**

- AddPac IP-PBX
- Asterisk IP-PBX (*)
- BroadWorks IP-PBX



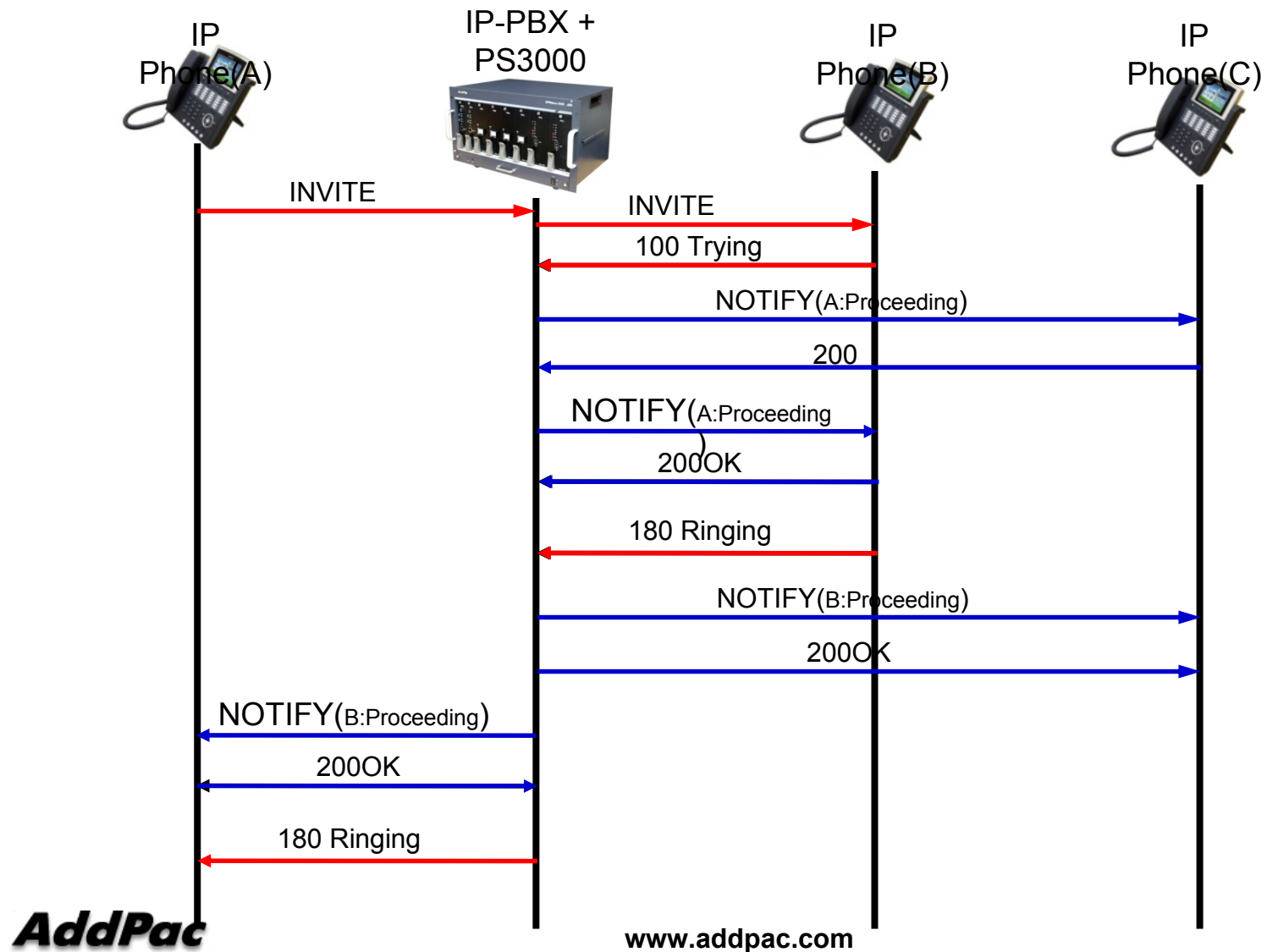



BLF Message Flow Example



BLF IP Phone Comparison Table

	AP-IP300	AP-IP230	AP-IP160	AP-IP120
				
LCD Size	4.3 Inch Color LCD	5 Inch Color LCD	4 Text Line Graphic LCD	4 Text Line Graphic LCD
Touch Screen	N/A	Support	N/A	N/A
Speed-Dial Keys	25 Key with Presence LED	Touch Screen based 25 Keys	16 Key with Presence LED	12 Key with Presence LED
Voice Codec	G.711/G.726/ G.729/G.723	G.711/G.726/ G.729/G.723	G.711/G.726/ G.729/G.723	G.711/G.726/ G.729/G.723
Signaling	H.323/SIP	H.323/SIP	H.323/SIP	H.323/SIP
3-Party Conversation	Support	Support	Support	Support
LAN Port	2	2	2	2
PoE(Optional)	Support	Support	Support	Support
FXO(Optional)	Support	Support	Support	Support

BLF IP Video Phone Comparison Table

	AP-VP500	AP-VP300N	AP-VP280	AP-VP250	AP-VP230	AP-VP120
						
LCD Size	12.1 Inch Touch Screen	7Inch Touch Screen	7Inch Touch Screen	4.3Inch Touch Screen	5Inch Touch Screen	4.3Inch
Camera	CCD	CCD	CMOS	CMOS	CMOS	CMOS
Video Codec	H.263 MPEG4 H.264	H.263 MPEG4 H.264	H.263 MPEG4 H.264	H.263 MPEG4 H.264	H.263 MPEG4 H.264	H.263 MPEG4 H.264
Signaling	H.323/SIP	H.323/SIP	H.323/SIP	H.323/SIP	H.323/SIP	H.323/SIP
Video MCU	N/A	N/A	N/A	N/A	N/A	N/A
Voice MCU	3-Party	3-Party	3-Party	3-Party	3-Party	3-Party
LAN Port	2	2	2	2	2	2
PoE	N/A	Support	N/A	Support	Support	Support



AP-IP300 IP Phone

IP Phone

AP-IP300 Premium IP Phone

Main Features

- 4.3 Inch Color LCD Display
- 25 Speed-Dial Keys with User Presence LED
- 4 Soft Key for Call Control
- Various Function Keys
- H.323/SIP Concurrent VoIP Signaling Stack Embedded
- High-performance Voice Codec Support
 - G.711/G.726/G.729/G.723, etc
- Two(2) 10/100Mbps Fast Ethernet (IP Share ,etc)
- High Quality Speaker Phone Features (Acoustic Echo Canceller)
- Powerful Network Protocols (PPPoE, DHCP, Static Routing, etc)
- Firmware Upgradeable Architecture
- VPMS (VoIP Plug&Play Management System) for Large Scale Deployment
- Advanced Voice QoS Mechanism

IP Phone

AP-IP300 Premium IP Phone

RISC
CPU

High-end
DSP

Hardware Specification

- RISC Microprocessor Computing Power
- 4.3 Color LCD
- 25 Speed Dial Keys with User Presence LED
- High-end Programmable DSP Hardware Architecture
- High quality Audio and Voice Interface
 - Stereo Audio Input & Output Connector
- Network Interface
 - Two(2) 10/100Mbps Fast Ethernet
 - One(1) USB 1.0 Interface
- PSTN Interface
 - One(1) FXO(RJ11) interface
- Power Supply
 - *External DC adaptor (5V)*
 - *Power Switch*
 - *PoE (Power over Ethernet)*

IP Phone

AP-IP300 Premium IP Phone

RISC
CPU

High-end
DSP

Hardware Specification



AddPac

www.addpac.com

IP Phone

AP-IP300 Premium IP Phone

Hardware Specification

RISC
CPU

High-end
DSP

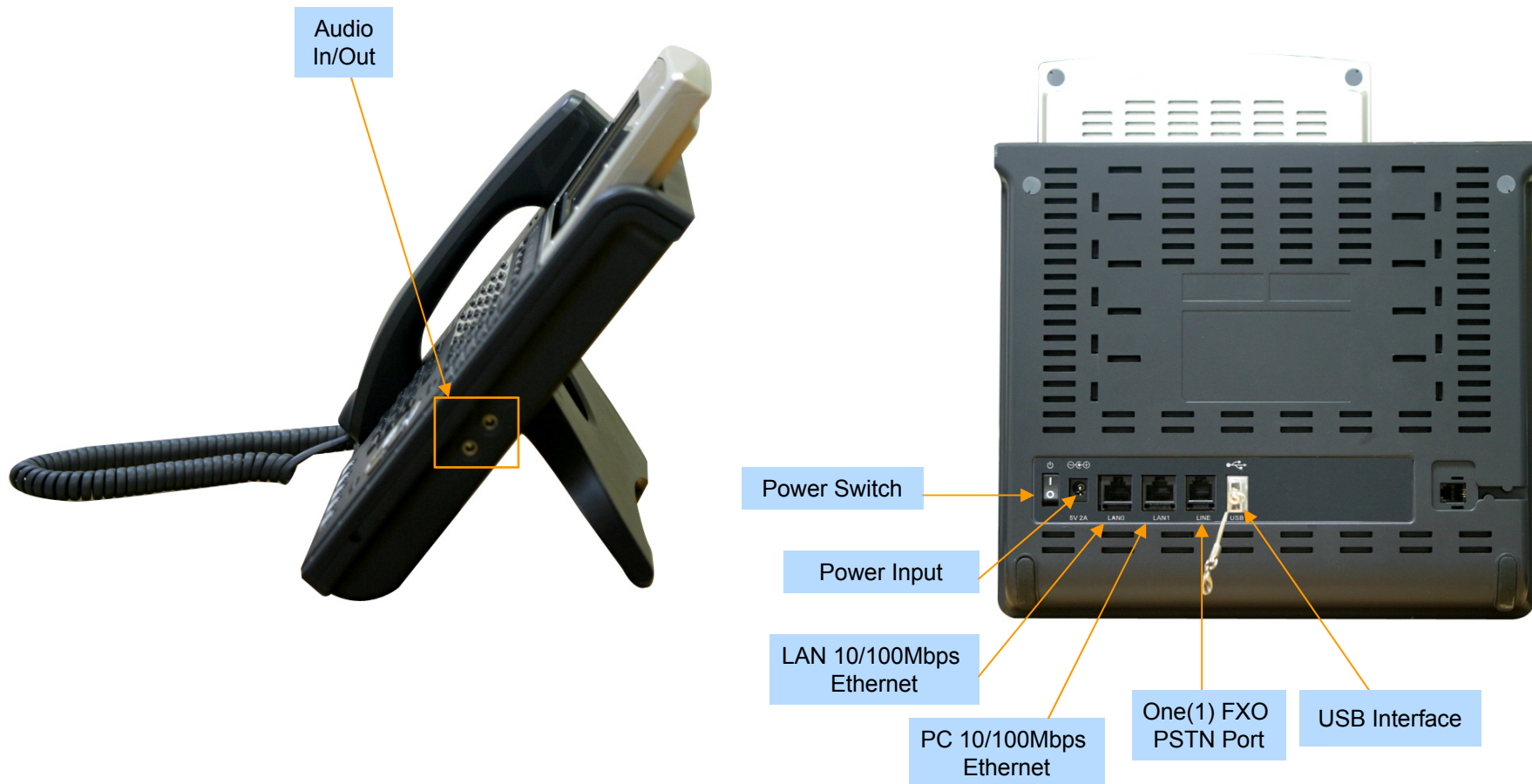



AP-IP230 IP Phone

IP Phone

AP-IP230 Premium IP Phone

Main Features

- 5 Inch Color LCD Display, Touch Screen
- Touch Screen based 25 Speed-Dial Keys
- 4 Soft Key for Call Control
- Various Function Keys
- H.323/SIP Concurrent VoIP Signaling Stack Embedded
- High-performance Voice Codec Support
 - G.711/G.726/G.729/G.723, etc
- Two(2) 10/100Mbps Fast Ethernet (IP Share ,etc)
- High Quality Speaker Phone Features (Acoustic Echo Canceller)
- Powerful Network Protocols (PPPoE, DHCP, Static Routing, etc)
- Firmware Upgradeable Architecture
- VPMS (VoIP Plug&Play Management System) for Large Scale Deployment
- Advanced Voice QoS Mechanism

IP Phone

AP-IP230 Premium IP Phone

RISC
CPU

High-end
DSP

Hardware Specification

- RISC Microprocessor Computing Power
- 5 Inch Color LCD with Touch Screen
- High-end Programmable DSP Hardware Architecture
- High quality Audio and Voice Interface
 - Stereo Audio Input & Output Connector
- Network Interface
 - Two(2) 10/100Mbps Fast Ethernet
 - One(1) USB 1.0 Interface
- PSTN Interface
 - One(1) FXO(RJ11) interface
- Power Supply
 - *External DC adaptor (5V)*
 - *Power Switch*
 - *PoE (Power over Ethernet)*

IP Phone

AP-IP230 Premium IP Phone

Hardware Specification

RISC
CPU

High-end
DSP

5 Inch
LCD with Touch
Screen



AddPac

www.addpac.com

IP Phone

AP-IP230 Premium IP Phone

RISC
CPU

High-end
DSP

Hardware Specification

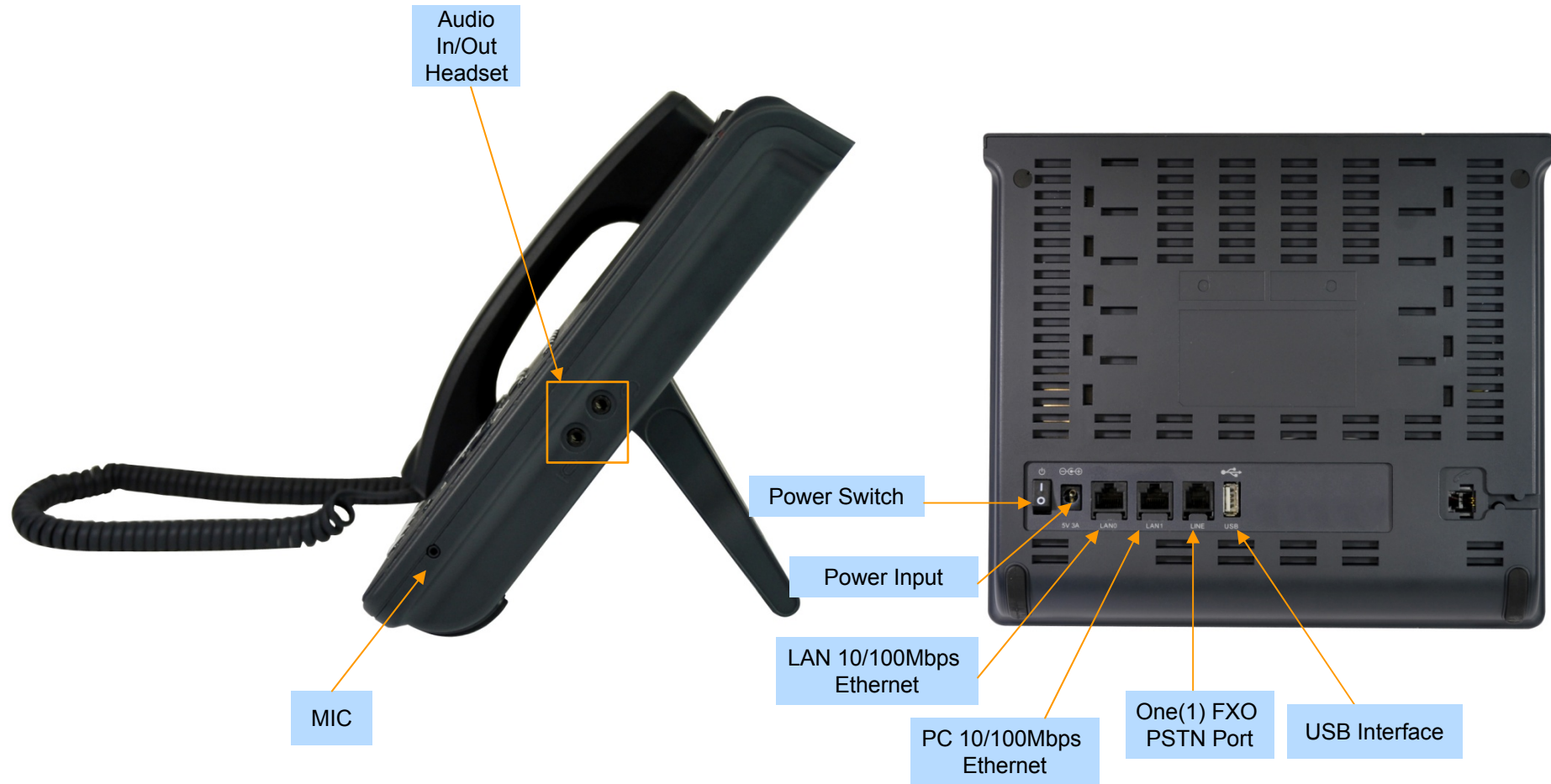



AP-IP160 IP Phone

IP Phone

AP-IP160 IP Phone

Main Features

- 4 Text Line Graphic LCD Display
- 16 Speed-Dial Keys with User Presence LED
- 4 Soft Key for Call Control
- Various Function Keys
- H.323/SIP Concurrent VoIP Signaling Stack Embedded
- High-performance Voice Codec Support
 - G.711/G.726/G.729/G.723, etc
- Two(2) 10/100Mbps Fast Ethernet (IP Share ,etc)
- High Quality Speaker Phone Features (Acoustic Echo Canceller)
- Powerful Network Protocols (PPPoE, DHCP, Static Routing, etc)
- Firmware Upgradeable Architecture
- VPMS (VoIP Plug&Play Management System) for Large Scale Deployment
- Advanced Voice QoS Mechanism

IP Phone

AP-IP160 IP Phone

RISC
CPU

High-end
DSP

Hardware Specification

- RISC Microprocessor Computing Power
- 4 Text Line Graphic LCD
- Navigation Key for Menu Search
- High-end Programmable DSP Hardware Architecture
- High quality Audio and Voice Interface
 - Stereo Audio Input & Output Connector
- Network Interface
 - Two(2) 10/100Mbps Fast Ethernet
- PSTN Interface
 - One(1) FXO(RJ11) interface
- Power Supply
 - *External DC adaptor (5V)*
 - *Power Switch*
 - *PoE (Power over Ethernet)*

IP Phone

AP-IP160 IP Phone

RISC
CPU

High-end
DSP

Hardware Specification



AddPac

www.addpac.com

IP Phone

AP-IP160 IP Phone

RISC
CPU

High-end
DSP

Hardware Specification

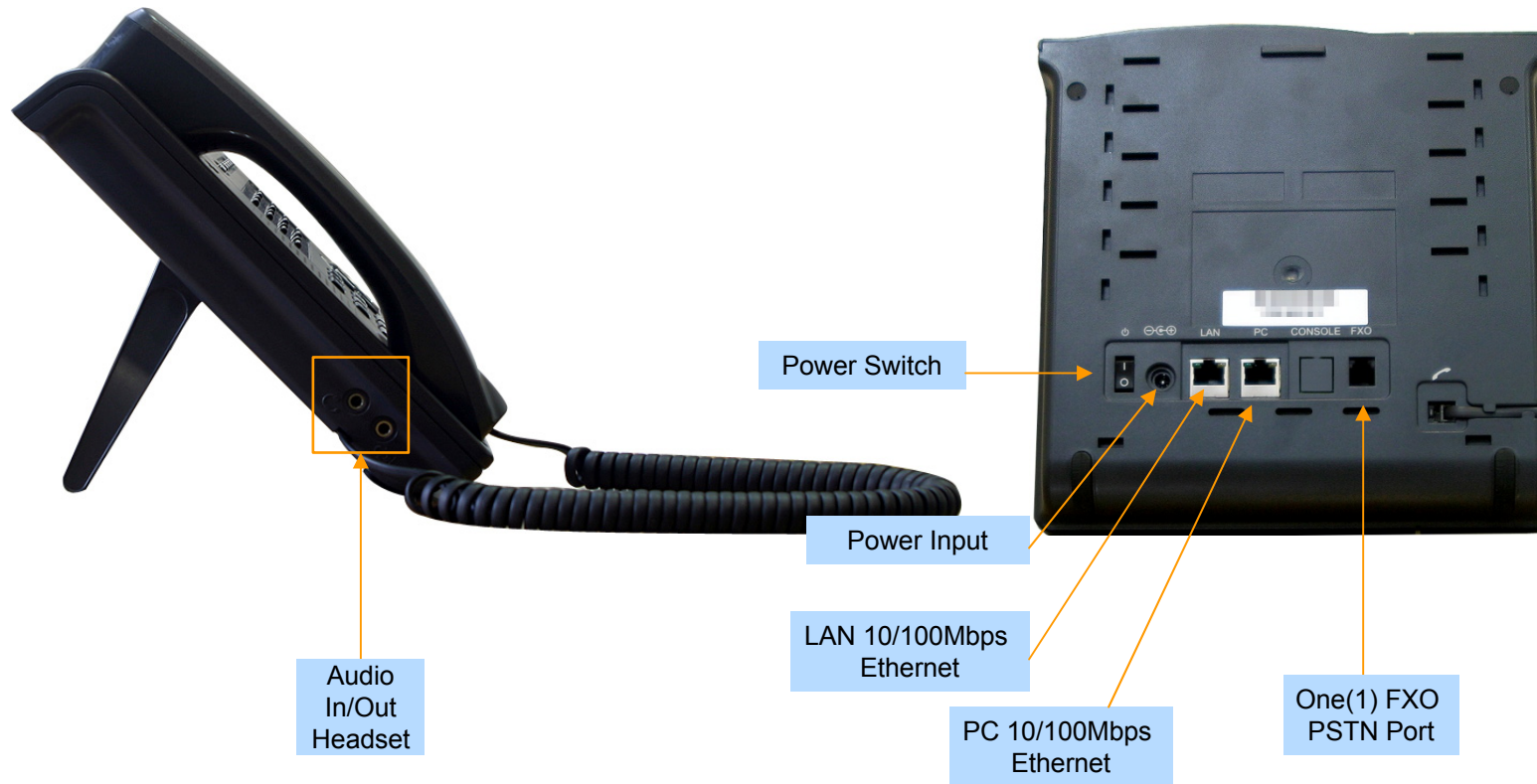



AP-IP120 IP Phone

IP Phone

AP-IP120 IP Phone

Main Features

- 4 Text Line Graphic LCD Display
- 12 Speed-Dial Keys with User Presence LED
- 4 Soft Key for Call Control
- Various Function Keys
- H.323/SIP Concurrent VoIP Signaling Stack Embedded
- High-performance Voice Codec Support
 - G.711/G.726/G.729/G.723, etc
- Two(2) 10/100Mbps Fast Ethernet (IP Share ,etc)
- High Quality Speaker Phone Features (Acoustic Echo Canceller)
- Powerful Network Protocols (PPPoE, DHCP, Static Routing, etc)
- Firmware Upgradeable Architecture
- VPMS (VoIP Plug&Play Management System) for Large Scale Deployment
- Advanced Voice QoS Mechanism

IP Phone

AP-IP120 IP Phone

RISC
CPU

High-end
DSP

Hardware Specification

- RISC Microprocessor Computing Power
- 4 Text Line Graphic LCD
- Navigation Key for Menu Search
- High-end Programmable DSP Hardware Architecture
- High quality Audio and Voice Interface
 - Stereo Audio Input & Output Connector
- Network Interface
 - Two(2) 10/100Mbps Fast Ethernet
- PSTN Interface
 - One(1) FXO(RJ11) interface
- Power Supply
 - *External DC adaptor (5V)*
 - *PoE (Power over Ethernet)*

IP Phone

AP-IP120 IP Phone

RISC
CPU

High-end
DSP

Hardware Specification





Thank you!

AddPac Technology Co., Ltd.
Sales and Marketing

Phone +82.2.568.3848 (KOREA)

FAX +82.2.568.3847 (KOREA)

E-mail : sales@addpac.com