

# GSM/CDMA Gateways

AVAYA PBX Trunk Interworking



**AddPac**

**AddPac Technology**

2011, Sales and Marketing

[www.addpac.com](http://www.addpac.com)

# Contents

- AVAYA GSM Interworking Network Diagram
- AVAYA GSM/CDMA Trunk Interface Network Diagram
- GSM/CDMA Gateways with Digital E1/T1 trunk
- GSM/CDMA/Digital Trunk Interface Module
- AP-GS3000 Platform Hardware Diagram
- AP-GS3000 Platform Module Combination Examples

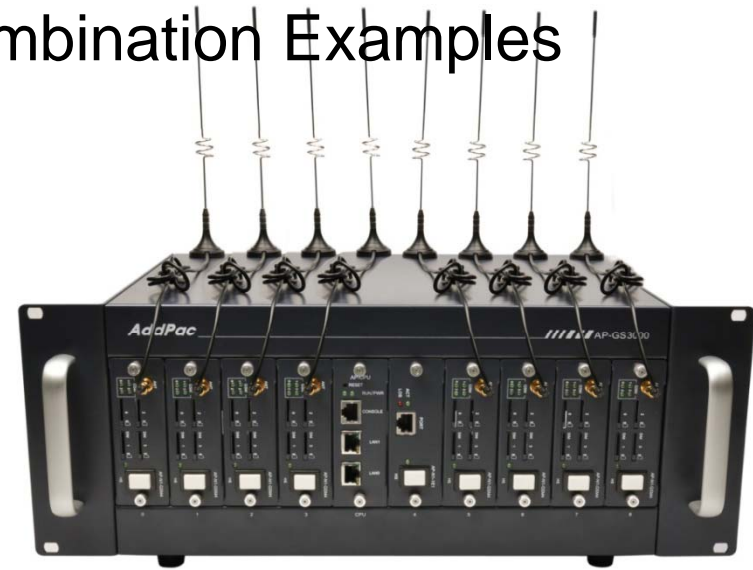

# AVAYA GSM Interworking Network Diagram



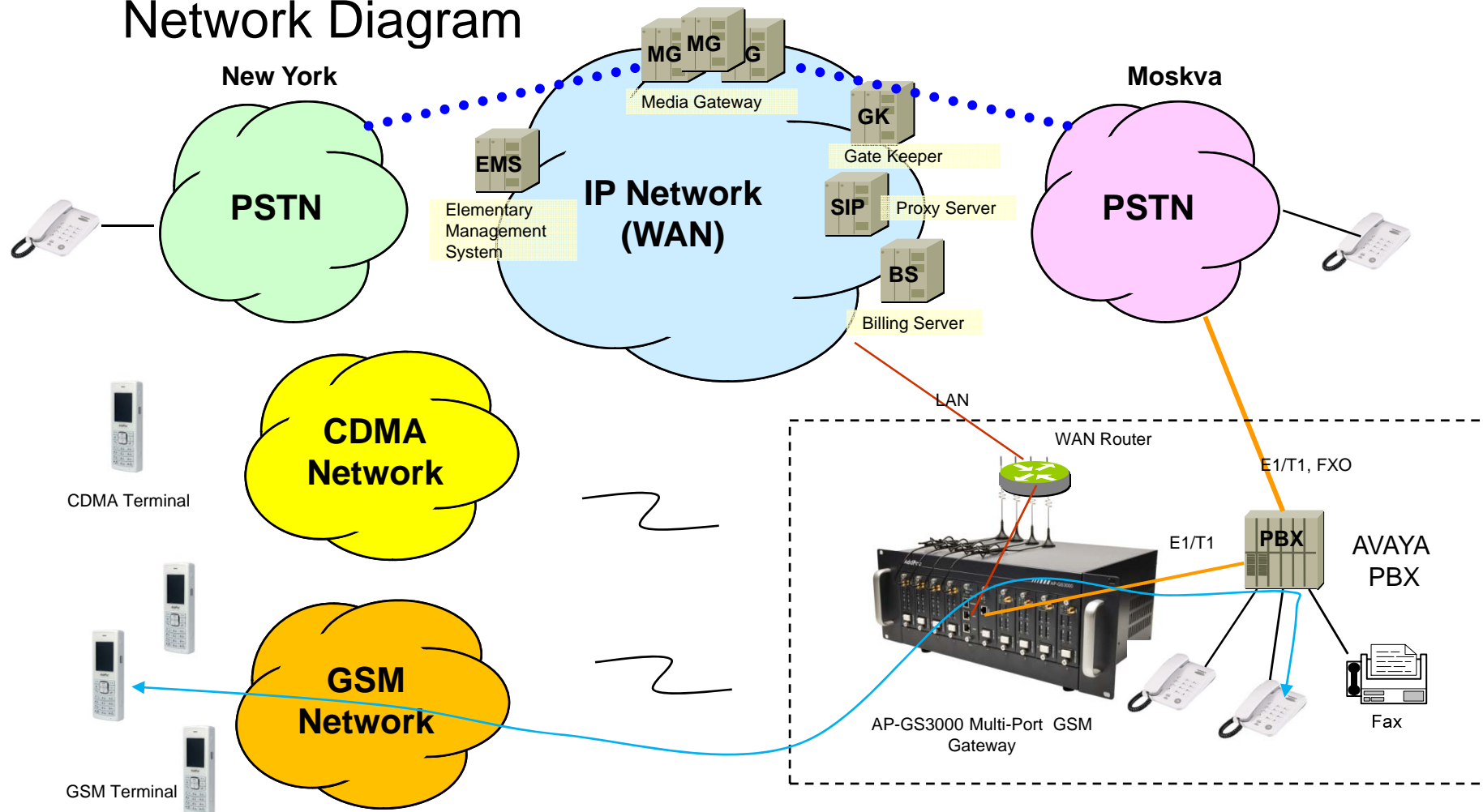

## Network Diagram

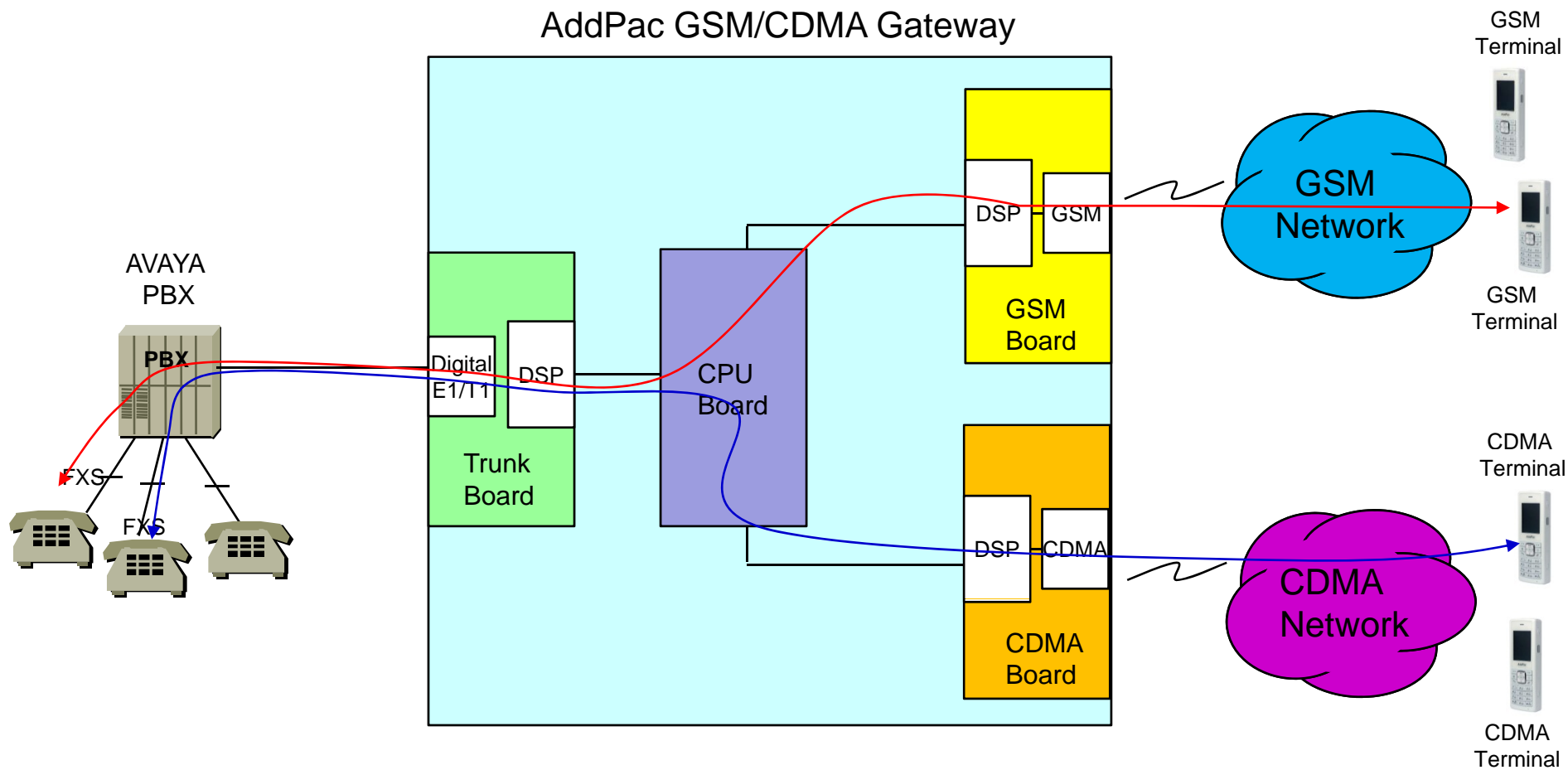

# GSM/CDMA Trunk Interface Network Diagram



# GSM/CDMA Gateways with Digital E1/T1 Trunk Interface

Model	AP-GS2500	AP-GS3000	AP-GS3500	AP-GS5000
				
Available Modules	AP-N1-GSM4 AP-N1-CDMA4 AP-N1-FXS8 AP-N1-FXO8 AP-N1-FXS4O4 AP-N1-E1	AP-N1-GSM4 AP-N1-CDMA4 AP-N1-FXS8 AP-N1-FXO8 AP-N1-FXS4O4 AP-N1-E1	AP-N1-GSM4 AP-N1-CDMA4 AP-N1-FXS8 AP-N1-FXO8 AP-N1-FXS4O4 AP-N1-E1	AP-N1-GSM8 AP-N1-FXS8 AP-N1-FXO8 AP-N1-E1 AP-N1-2E1
GSM Channel	Up to 16 Channel	Up to 36 Channel	Up to 36 Channel	Up to 80 Channel
GSM Antenna	One(1) / 4 Channel GSM Module (AP-N1-GSM4)	One(1) / 4 Channel GSM Module (AP-N1-GSM4)	One(1) / 4 Channel GSM Module (AP-N1-GSM4)	Two(2) / 8 Channel GSM Module(AP-N1-GSM8)
Module Slot	Four(4) Module Slots for GSM	Nine(9) Module Slots for GSM, E1/T1 Module Slot	Nine(9) Module Slots for GSM, E1/T1 Module Slot	Ten(10) Module Slots for GSM, E1/T1 Module Slot
LAN Port	2	2	2	2
Console	1	1	1	1
Power	Single PSU	Single PSU	Dual PSU(module)	Dual PSU (module)

# GSM/CDMA/Digital Trunk Interface Module

**AP-N1-GSM4** 4-Port GSM Module

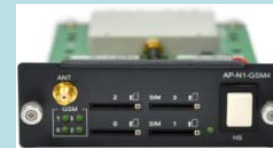

**AP-N1-CDMA4** 4-Port CDMA Module



**AP-N1-E1** 1-Port Digital E1/T1 Module



# AP-GS3000 GSM/CDMA/Digital Trunk Interface

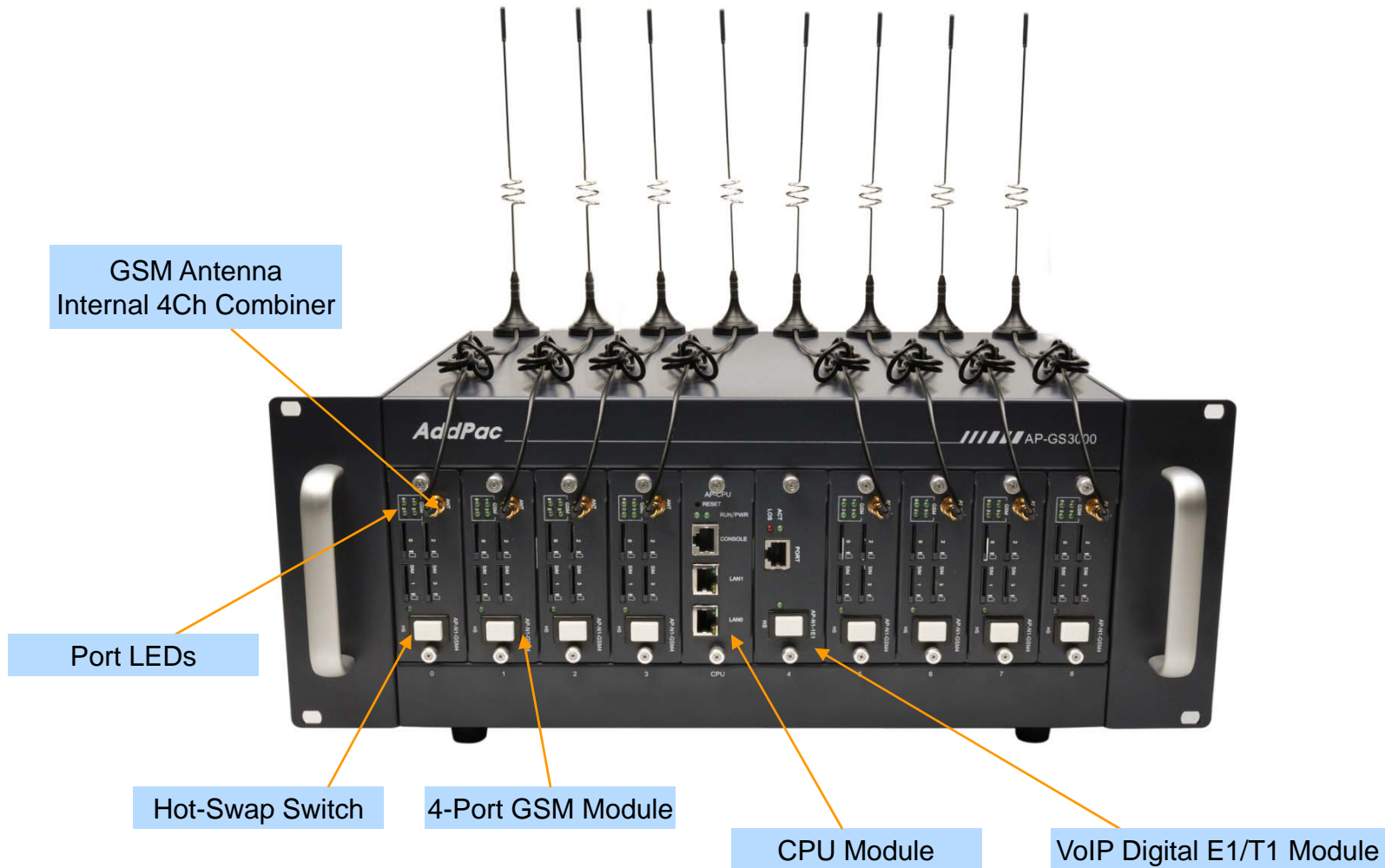

# AP-GS3000 Platform Module Combination Examples

High-end  
**DSP**

1x AP-N1-E1/T1 Module + 8xAP-N1-GSM4 Module = Digital E1 Interface + 32Port GSM Channel



1xAP-N1-E1/T1 Module + 8xAP-N1-CDMA4 Module = Digital E1 Interface + 32Port CDMA Channel



1xAP-N1-E1/T1 Module + 4xAP-N1-GSM4 Module + 4xAP-N1-CDMA4 Module = Digital E1 Interface + 16Port GSM Channel + 16Port CDMA Channel





# GSM/CDMA Gateway Series

# Thank you!

**AddPac Technology Co., Ltd.**  
Sales and Marketing

Phone +82.2.568.3848 (KOREA)

FAX +82.2.568.3847 (KOREA)

E-mail [sales@addpac.com](mailto:sales@addpac.com)