

# AP-GS1500

## Multi-Port GSM Gateway

High Performance GSM Gateway Solution

### Preliminary Product Overview

(Without notice, following described technical spec. can be changed)



# **AddPac**

**AddPac Technology**

Sales and Marketing

[www.addpac.com](http://www.addpac.com)

# Contents

## AP-GS1500 Multi-Port GSM Gateway

- Product Overview
- Hardware Specification
- GSM Module Specification
- APOS Technology
- VoIP (Voice over IP) service
- Advanced QoS Features
- Network Protocols
- Network Management
- Smart Web Management
- Security Management
- Application Service
- Ordering Information



# Product Overview

## AP-GS1500 Multi-Port GSM Gateway

- Two(2) Module Slots for 4-Port GSM Module, 8FXS/8FXO Analog Interface (Up to 8-Port GSM)
- H.323/SIP/MGCP Triple Concurrent Stack Embedded
- High Performance RISC & Programmable DSP Architecture
- G.711/G.726/G.723/G.729, T.38 Fax , VAD, etc
- Powerful Network Protocols (PPPoE, DHCP, Static Routing, etc)
- Two(2)10/100Mbps Fast Ethernet
- One(1) RS-232C Port for Command Line Interface
- Firmware Upgradeable Architecture
- VPMS (VoIP Plug&Play Management System) for Large Scale Deployment
- Advanced Voice QoS Mechanism
- Smart Web Manager
- Rack Mountable Chassis with Internal Power Supply

# Product Highlights

## AP-GS1500 Multi-Port GSM Gateway

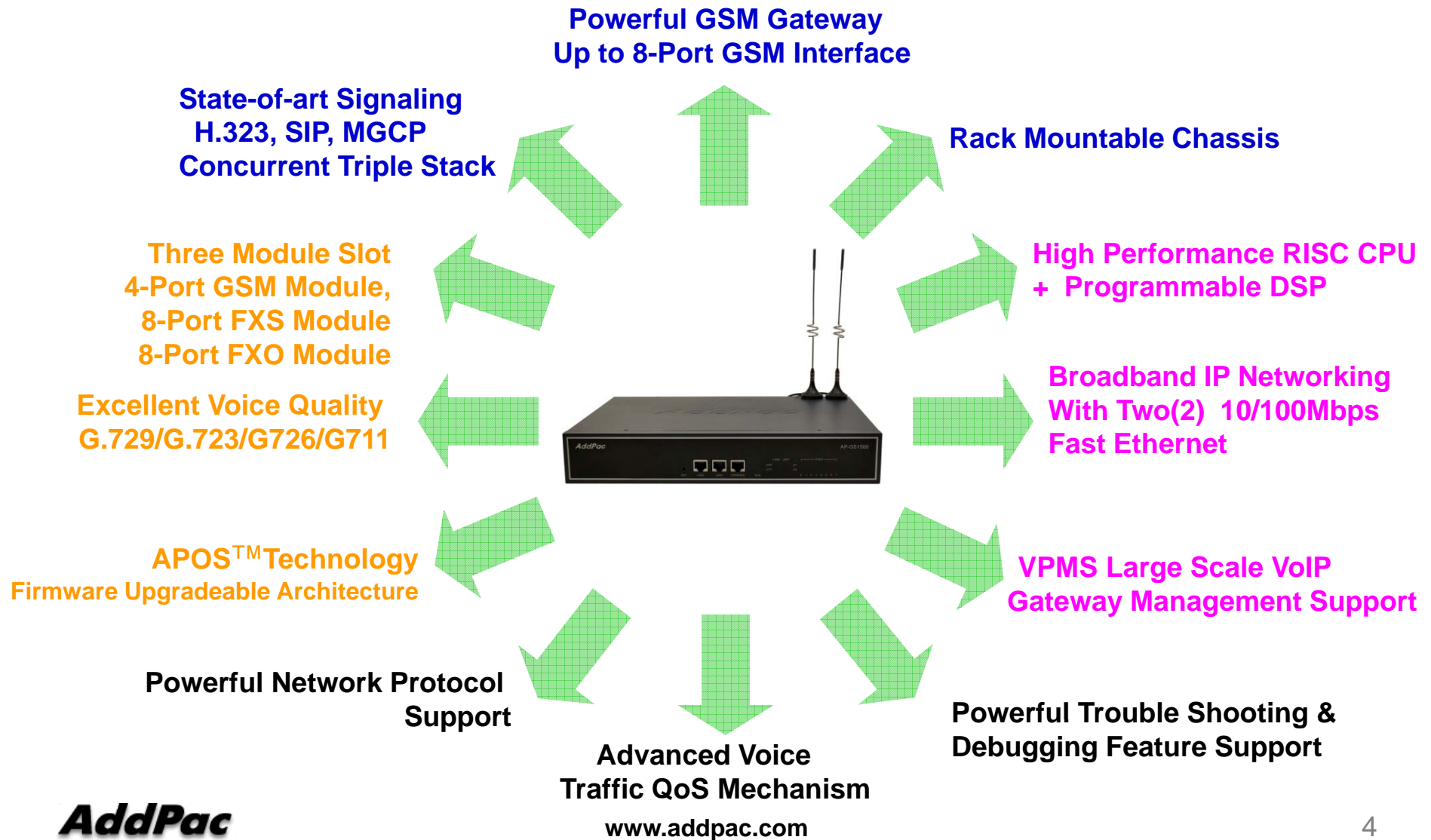

# APOS Technology

AP-GS1500 Multi-Port GSM Gateway

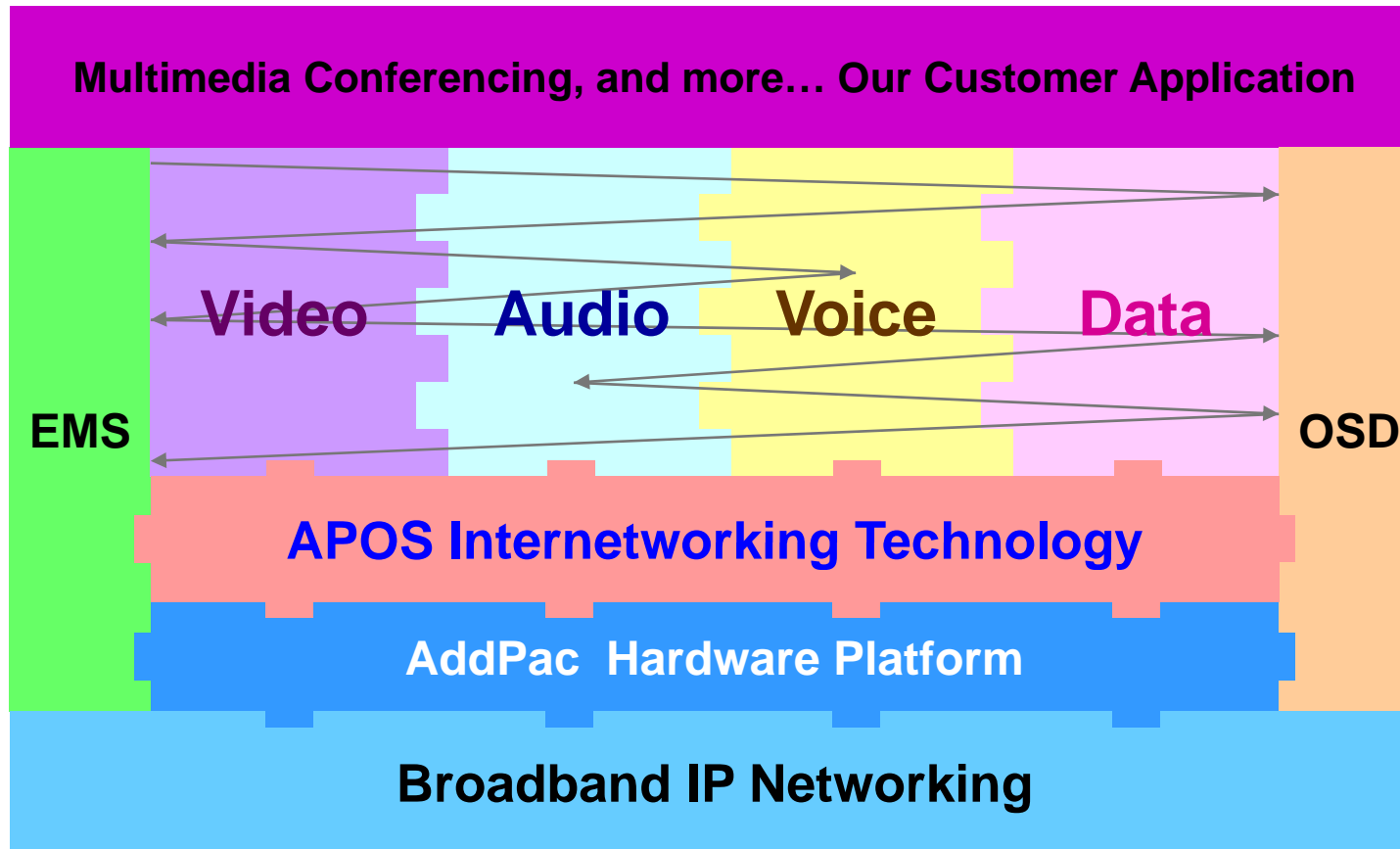

- APOS : AddPac Internetworking Operating System
- OSD : On- Screen Display
- EMS : Element Management System

# Hardware Specification

## AP-GS1500 Multi-Port GSM Gateway

RISC  
CPU

High-end  
DSP

- RISC Microprocessor Computing Power
- Two(2) Module Slot for GSM, Analog Interface
- 4-Port GSM Module(AP-N1-GSM4)
  - 4-Port SIM Card Slot
  - One(1) GSM Antenna Interface (Internal 4 Channel Combiner)
  - Hot-Swap
- VoIP Interface Module
  - 8-Port FXS Module (AP-N1-FXS8)
  - 8-Port FXO Module (AP-N1-FXO8)
  - Hot-Swap
- Network Interface
  - Two(2) 10/100Mbps Fast Ethernet (RJ45)
- RS232C Console Interface for CLI
- Run LED, LAN LED, Port LEDs
- Internal Power Supply



# Hardware Specification

AP-GS1500 Multi-Port GSM Gateway

RISC  
CPU

High-end  
DSP

## Hardware Specifications

AP-GS1500 GSM Gateway	Basic Specifications
GSM Interface	Two(2) GSM Module Slots
	AP-N1-GSM4, AP-N1-FXS8, AP-N1-FXO8, AP-N1-FXS4O4
Ethernet Interface	2-Ports 10/100Mbps Ethernet Interface(RJ-45)
Flash Memory	4Mbyte High-speed Flash Memory
Base Memory	32Mbyte High-speed SDRAM
Power Requirement	Power Supply / VAC 110~220V, 50/60Hz, 5V 8A
Operating Temperature	0°C ~ 45°C (32 °F ~ 122°F)
Storage Temperature	-40°C ~ 85°C (-40°C ~ 185°F)
Relative Humidity	5% ~ 95% (Non-condensing)
Dimensions	W×D×H (340×267×55mm)
Weight(kg)	2.5 Kg

# Hardware Specification

AP-GS1500 Multi-Port GSM Gateway

RISC  
CPU

High-end  
DSP

## Front Side View

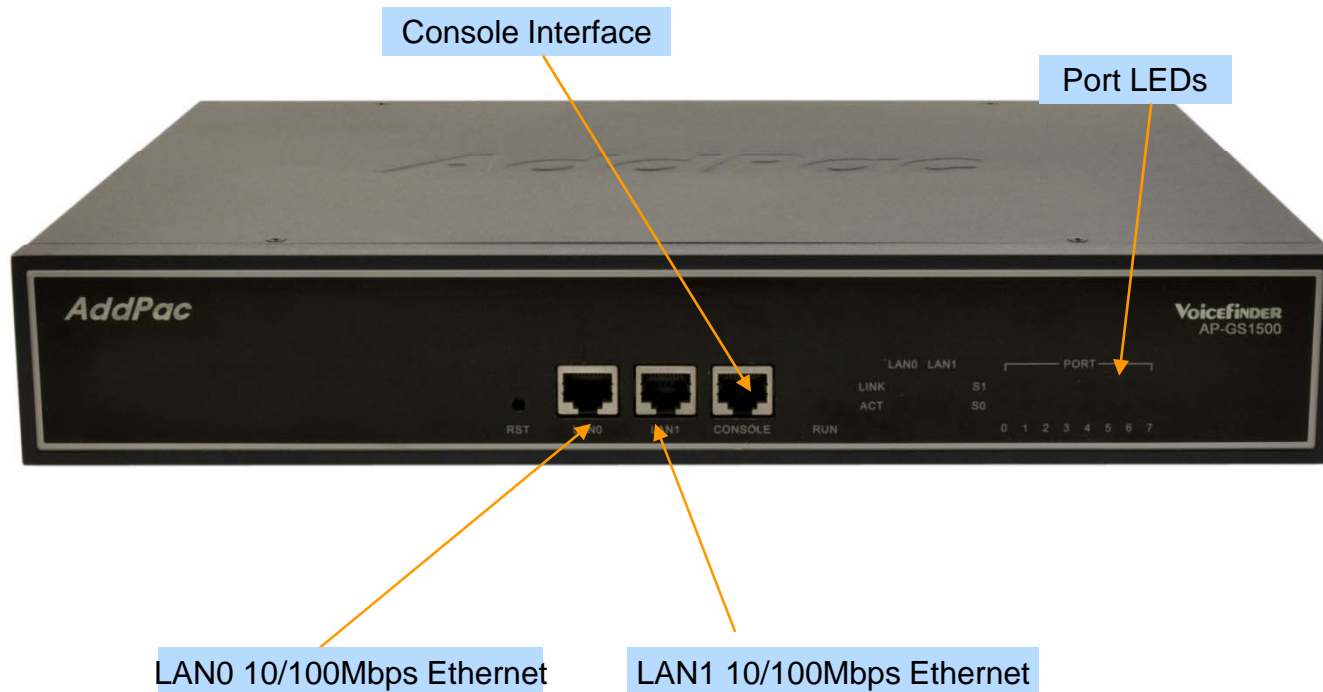



# Hardware Specification

AP-GS1500 Multi-Port GSM Gateway

RISC  
CPU

High-end  
DSP

## Back Side View

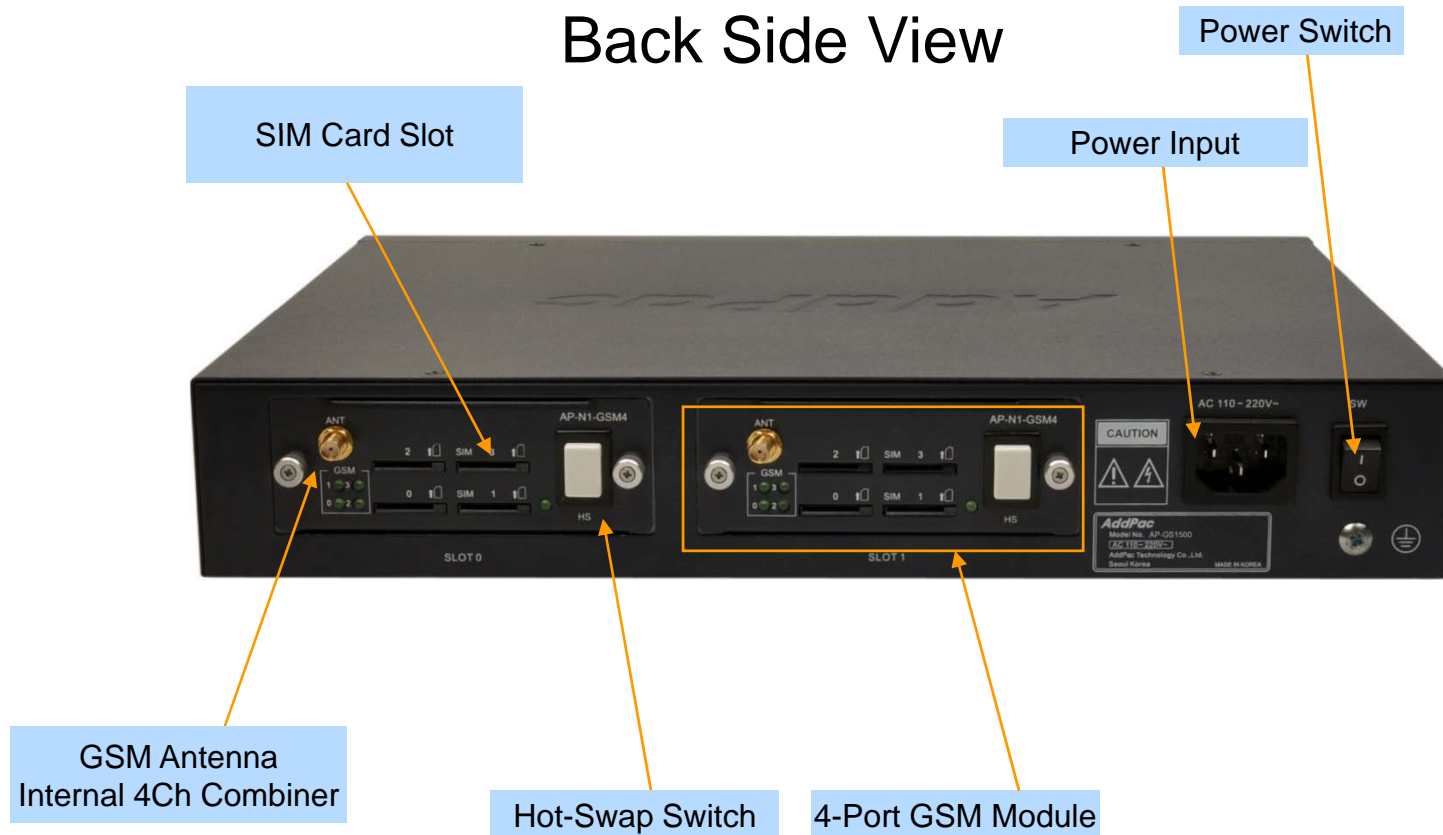

# Hardware Specification

AP-GS1500 Multi-Port GSM Gateway

RISC  
CPU

High-end  
DSP

SIM Card Slot



AP-N1-GSM4  
(4-Port GSM Module)

GSM Antenna  
Internal 4Ch Combiner

Hot-Swap Switch

Port LEDs

# Hardware Specification

AP-GS1500 Multi-Port GSM Gateway

RISC  
CPU

High-end  
DSP



AP-N1-FXS8  
(8-Port FXS Module)

AP-N1-FXO8  
(8-Port FXO Module)

# Hardware Specification

AP-GS1500 Multi-Port GSM Gateway

RISC  
CPU

High-end  
DSP

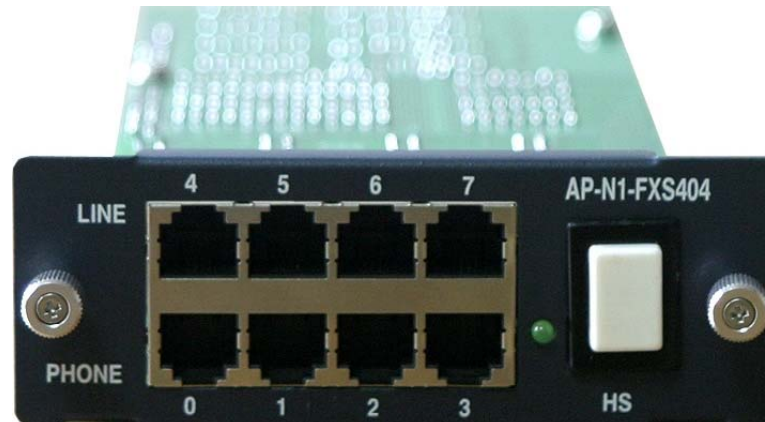

AP-N1-FXS404  
(4-Port FXS-  
4-Port FXO Module)

# Hardware Specification

AP-GS1500 Multi-Port GSM Gateway

RISC  
CPU

High-end  
DSP

## GSM Gateway Service Diagram

AP-N1-GSM4 4-Port GSM Module Internal H/W Block Diagram

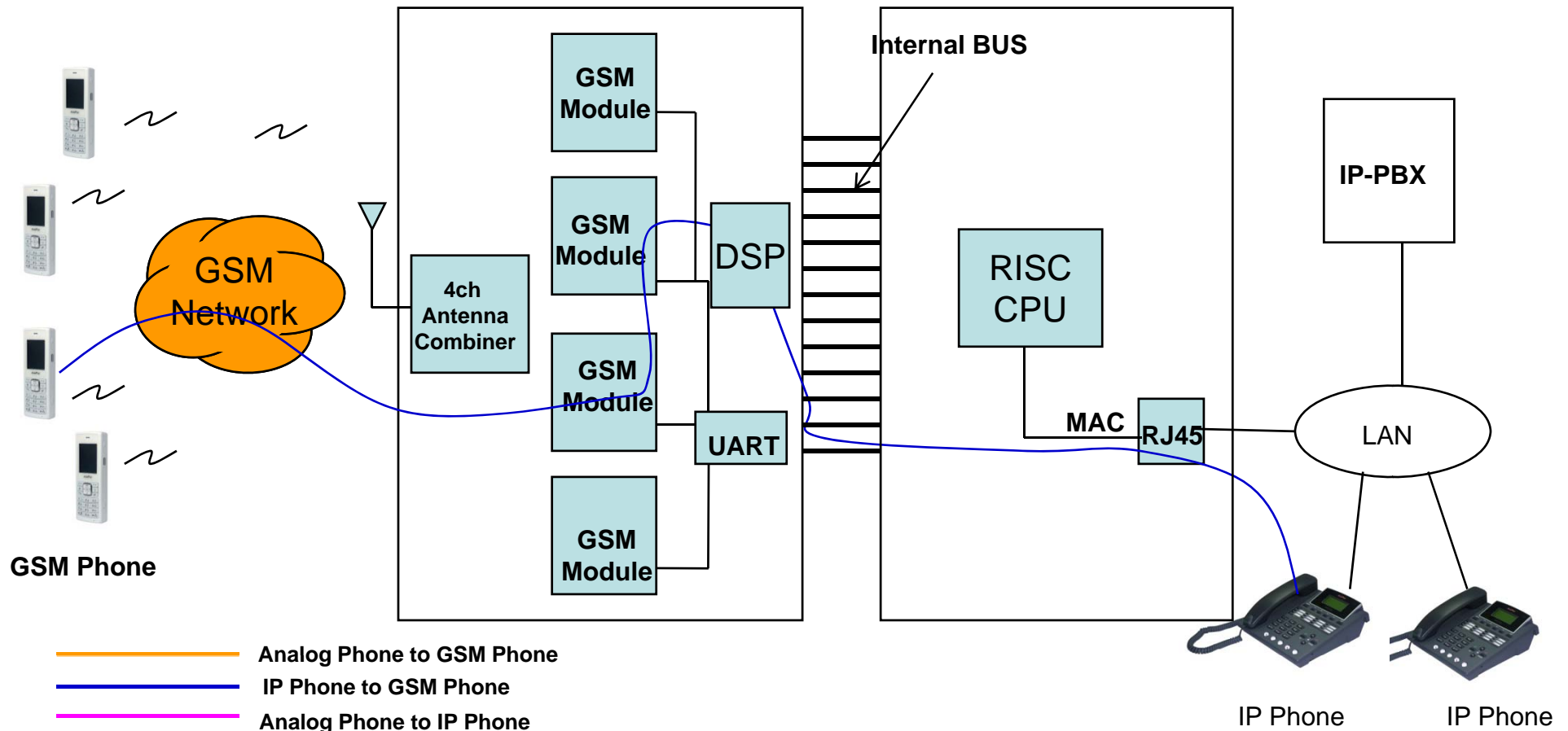

# Hardware Specification

AP-GS1500 Multi-Port GSM Gateway

RISC  
CPU

High-end  
DSP

## GSM Gateway Service Diagram

8-Port GSM Gateway Service Diagram

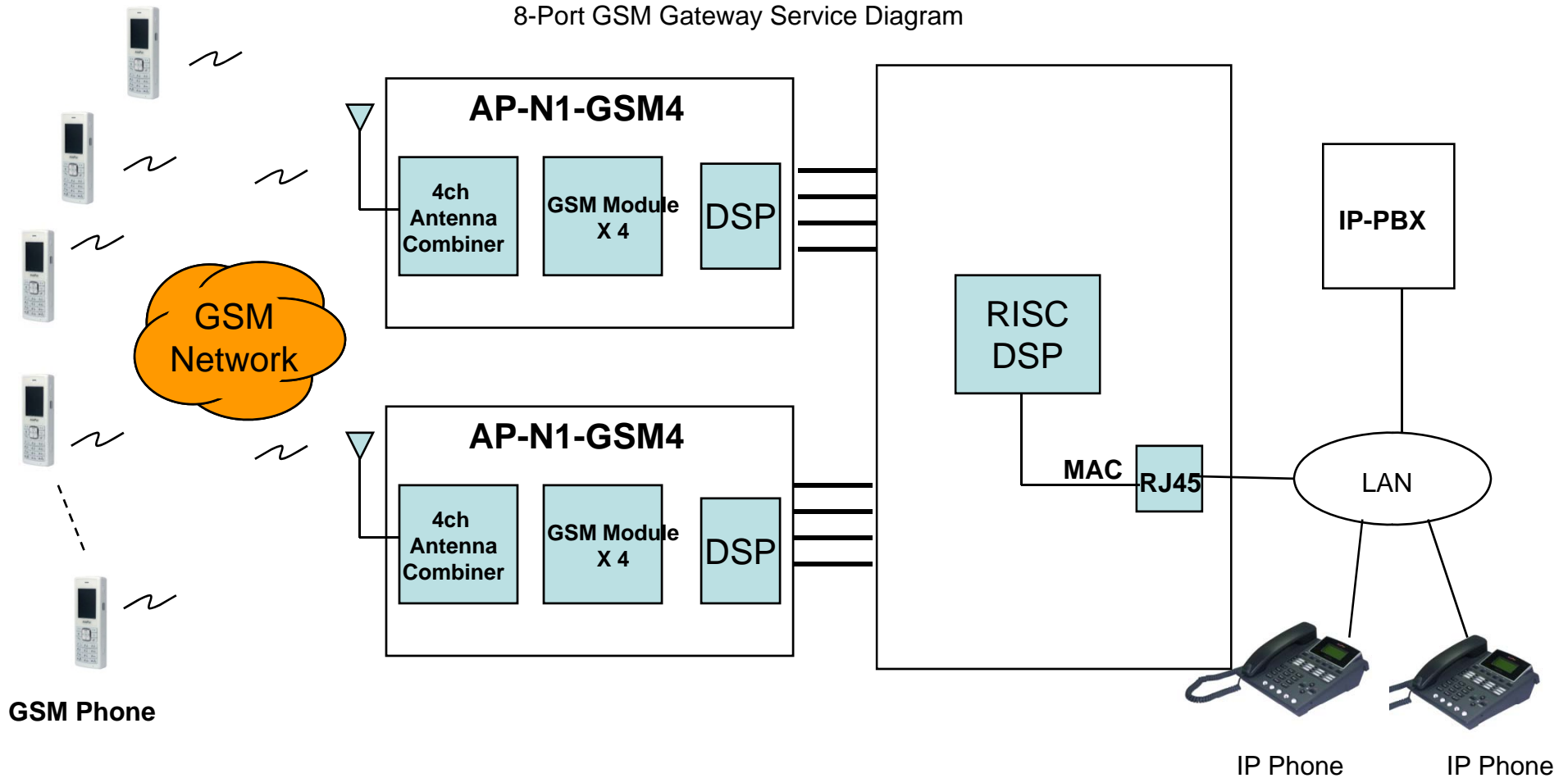

GSM Phone

IP Phone

IP Phone

# Hardware Specification

AP-GS1500 Multi-Port GSM Gateway

RISC  
CPU

High-end  
DSP

## GSM Gateway Service Diagram

4-Port GSM + 8-Port FXS Gateway Service Diagram

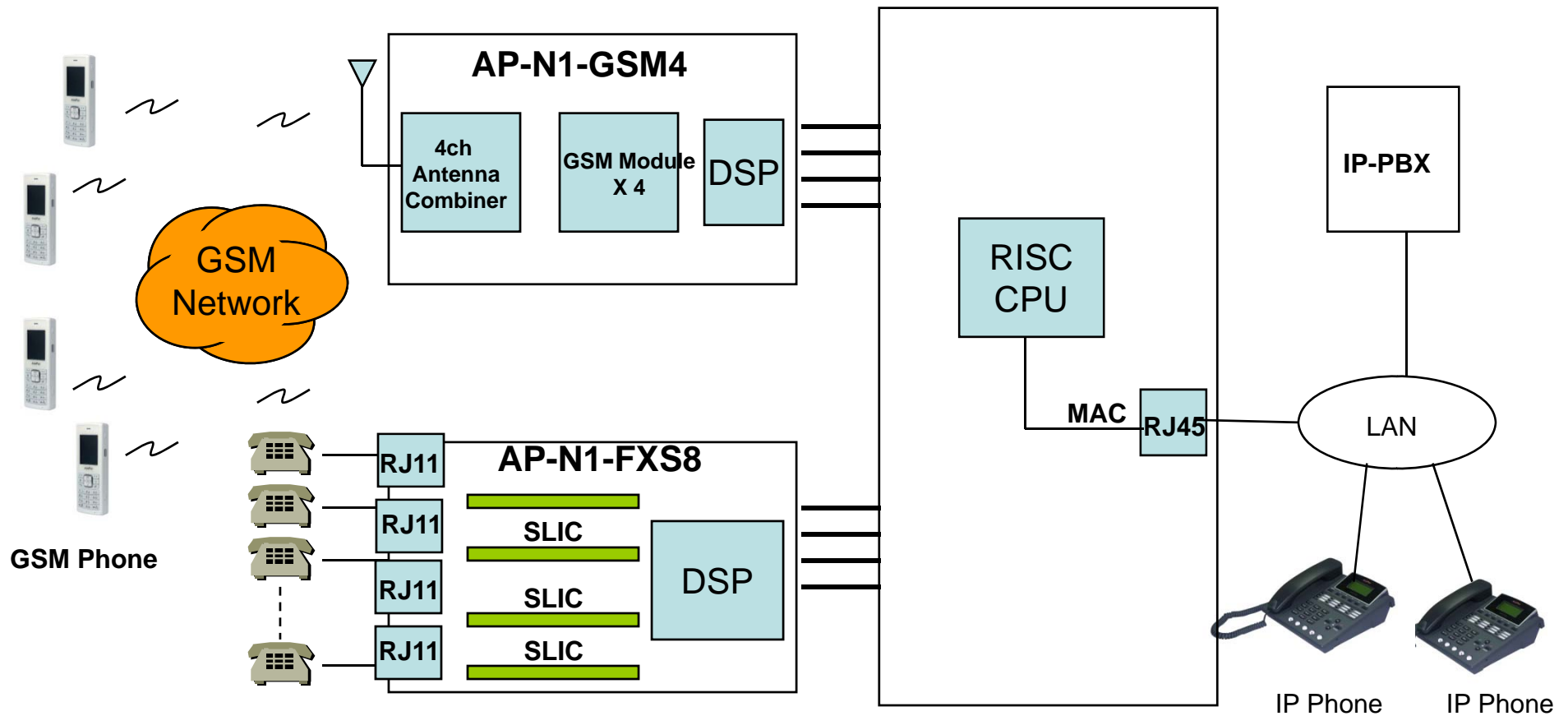

# GSM Module Specification

## AP-GS1500 Multi-Port GSM Gateway

- Bearers : GSM + GPRS class 10
- Quad-Band EGSM 850/900/1800/1900MHz
- Normal Sensitivity
  - 850MHz Rx           -104 dBm
  - 900MHz Rx           -104 dBm
  - 1800MHz Rx         -102 dBm
  - 1900MHz Rx         -102 dBm
- Tx Performances
  - 850MHz Tx           +33 dBm
  - 900MHz Tx           +33 dBm
  - 1800MHz Tx         +30 dBm
  - 1900MHz Tx         +30 dBm
- Power Consumption
  - 17 uA Sleep Mode, 1.7mA Idle Mode, 400mA GPRS class10 (33 dBm)
- Codec
  - FR-EFR-HR-AMR



# VoIP (Voice over IP) Service

## AP-GS1500 Multi-Port GSM Gateway

- **H.323, SIP, and MGCP Triple Stack**
- **H.323**
  - ITU-T Standard H.323 v3 Support
  - Support H.245 Tunneling
  - Including H.235 Security Features
- **SIP**
  - IETF RFC3261 or RFC2543 SIP Standard
- **MGCP**
  - IETF RFC2705bis-02 Standard MGCP 1.0

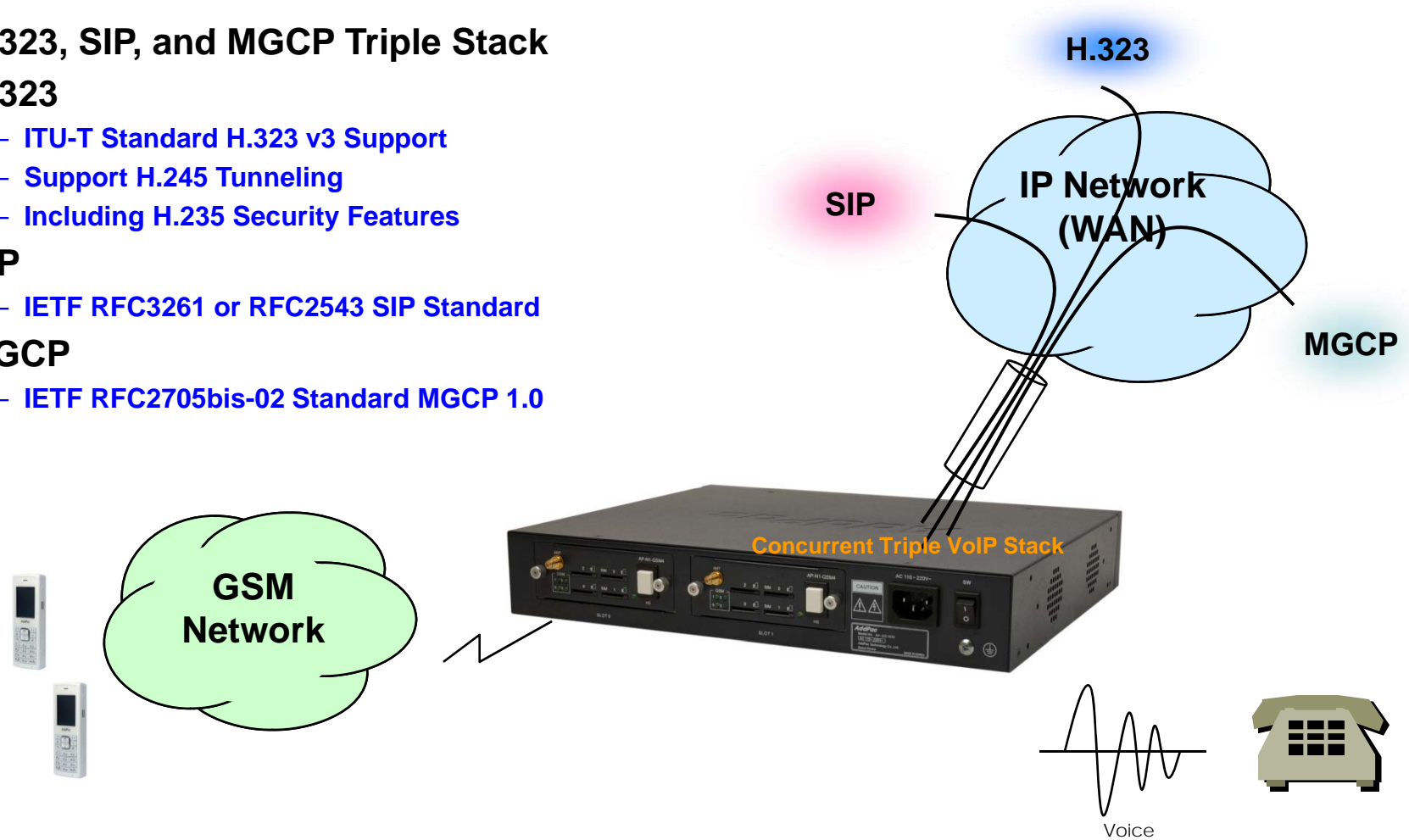

# VoIP (Voice over IP) Service

## AP-GS1500 Multi-Port GSM Gateway

- **H.323**

- Fast connect, normal connect support
- H.245 tunneling support
- Q.931 response message setting for inbound VoIP calls
- H.245 logical channel open timing selection function
- Start H.245 procedure support
- DTMF / Hook flash relay with H.245 alphanumeric / signal
- Secondary gatekeeper support
- Gatekeeper assignment according to the domain name
- Gatekeeper discovery with multicast
- Lightweight RRQ support
- Signaling TCP port assignment
- Resource threshold setting with RAI
- H.235 clear-token, crypto-token support
- canMapAlias support
- Technical prefix (supported prefix) support
- Public IP assignment in NAT environment

- **SIP**

- Gateway-based / Endpoint-based registration support
- Secondary proxy-server assignment function
- SIP signaling port change function
- SIP proxy server assignment according to the domain name
- T.38 real-time fax relay support
- DTMF relay support with RFC2833 / OPTION message
- Re-INVITE support

- **MGCP**

- Secondary call agent assignment function
- Default package assignment
- Announcement Server Package, Generic Media Package, Handset Package, Line Package, Trunk Package support
- MGCP call agent assignment according to the domain name
- T.38 real-time fax relay support
- DTMF relay support based on RFC2833

# VoIP (Voice over IP) Service

## AP-GS1500 Multi-Port GSM Gateway

- **Voice Codec**

- G.711 A-Law, G.711 U-Law
- G.726 r16, G.726 r32
- G.729A
- G.723.1 r63, G.723.1 r53
- VAD (Voice Activity Detection) function support
- DTMF relay support (H.323, SIP, MGCP common) based on RFC2833

- **RTP**

- Redundant RTP packet transmission in case of severe packet loss
- Dynamic jitter buffer management and RTP packet jitter and loss compensation with heuristic & DSP error concealment
- Static jitter buffer setting support
- Voice frame per RTP packet number control for each codec
- In-band ring-back tone support
- Virtual ring-back tone support
- Tone parameter change support

- **FAX**

- Fax relay mode supporting T.38, inband-T.38, bypass mode
- Lost packet compensation with redundant setting in case of T.38 fax relay
- Fax relay mode, rate setting for remote end

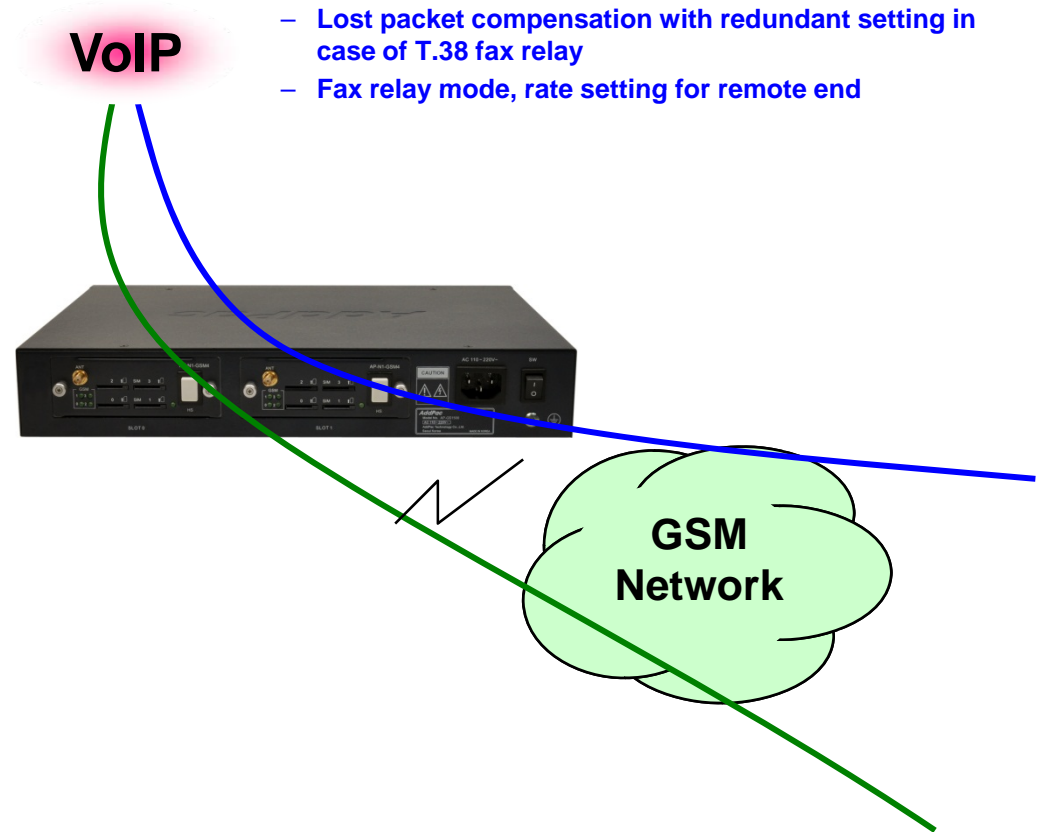

# VoIP (Voice over IP) Service

## AP-GS1500 Multi-Port GSM Gateway

### • VoIP Call Controls

- Hot line connection function with PLAR (Private Line Auto Ring Down)
- Leased line emulation function
- Connection monitoring function
- Fault tolerant with Redundancy and Call Distribution among Gateways for load balancing
- Call attempt with IP address
- H.323, SIP, MGCP inbound call connection for each voice port
- Multiple E.164 setting for one voice port
- One E.164 or digit pattern can be assigned to more than one voice port
- Hunting with Longest match/ priority/ sequence/ random
- One stage call setup by Digit forwarding
- Call barring with specific digit patterns
- Calling and called number conversion for PSTN outbound calls
- PSTN rerouting in case of VoIP call attempt failure

### • VoIP Call Controls (cont.)

- Call transfer for internal calls
- Call pickup for internal calls
- Calling and called number conversion for VoIP outbound calls
- Calling and called number conversion for VoIP inbound calls
- Fax broadcasting call control

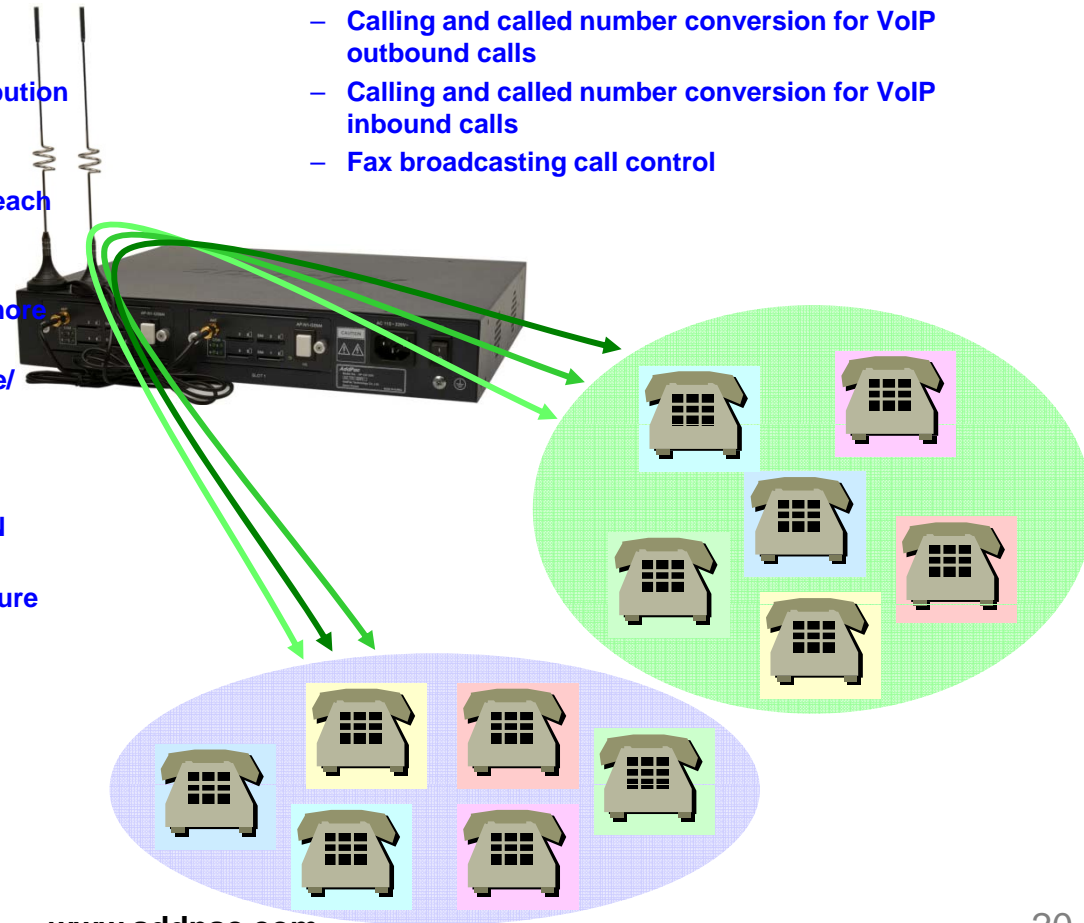

# Advanced QoS Features

## AP-GS1500 Multi-Port GSM Gateway

- Enhances **Transmit** Voice QoS Features
  - Voice Traffic Priority Queuing
  - QoS Service Profiling
  - Providing Virtual Network Transmit Algorithm
  - Real-time Voice Traffic QoS Support
  - RTP Packet Transmit Interval Control
  - Supporting RTP Packet Redundancy Scheme
  - IP Header Control such as ToS, Diffserv
- Enhances **Receive** Voice QoS Features
  - Dynamic Jitter Buffer Management
  - Error Concealment
  - Support T.38 FAX Data Error Recovery Scheme

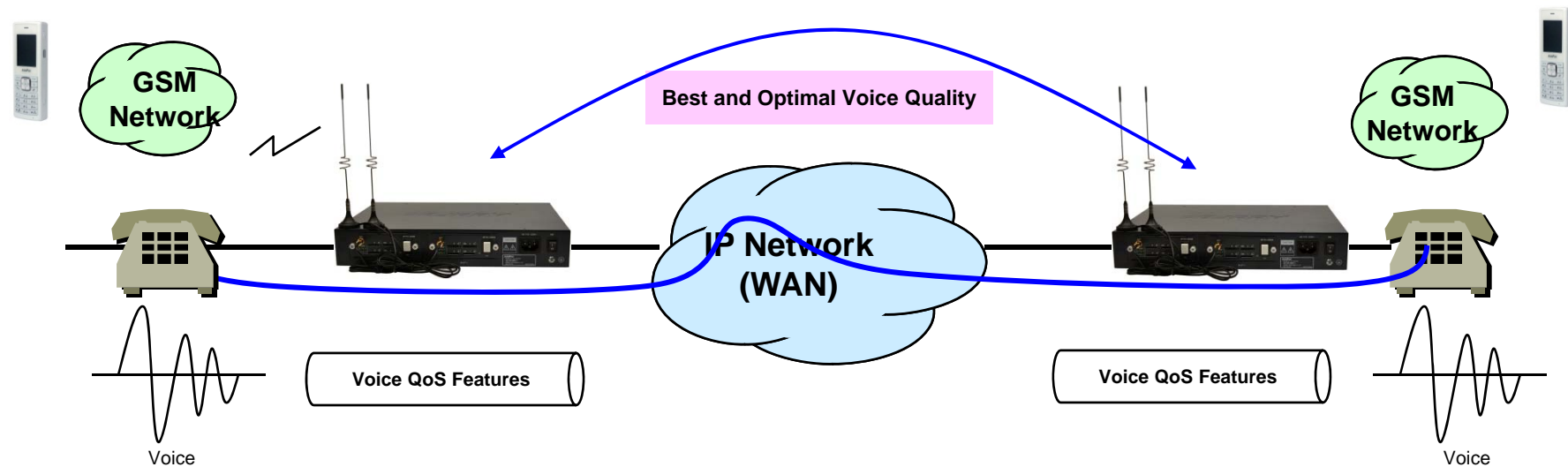

# Network Protocols

AP-GS1500 Multi-Port GSM Gateway

## Basic Network Protocols

- ARP, IPv4, TCP, UDP, ICMP, SCTP, IGMP, MLD

## Routing Protocol

- IPv4 : Static

## Service Protocol

- FTP, Telnet, TFTP, DHCP Server/Relay, SNMP Server
- CDP (Cisco Discovery Protocol)
- DNS Resolver , DDNS(nsupdate)
- Bridge
- Syslog

## IPv4 Address Configuration

- Fixed (Static)
- DHCP
- PPPoE

## Miscellaneous

- Cisco Style CLI
- Standard & Extended IPv4 Access List
- Multi-level User Account Management
- IP accounting
- STUN Client

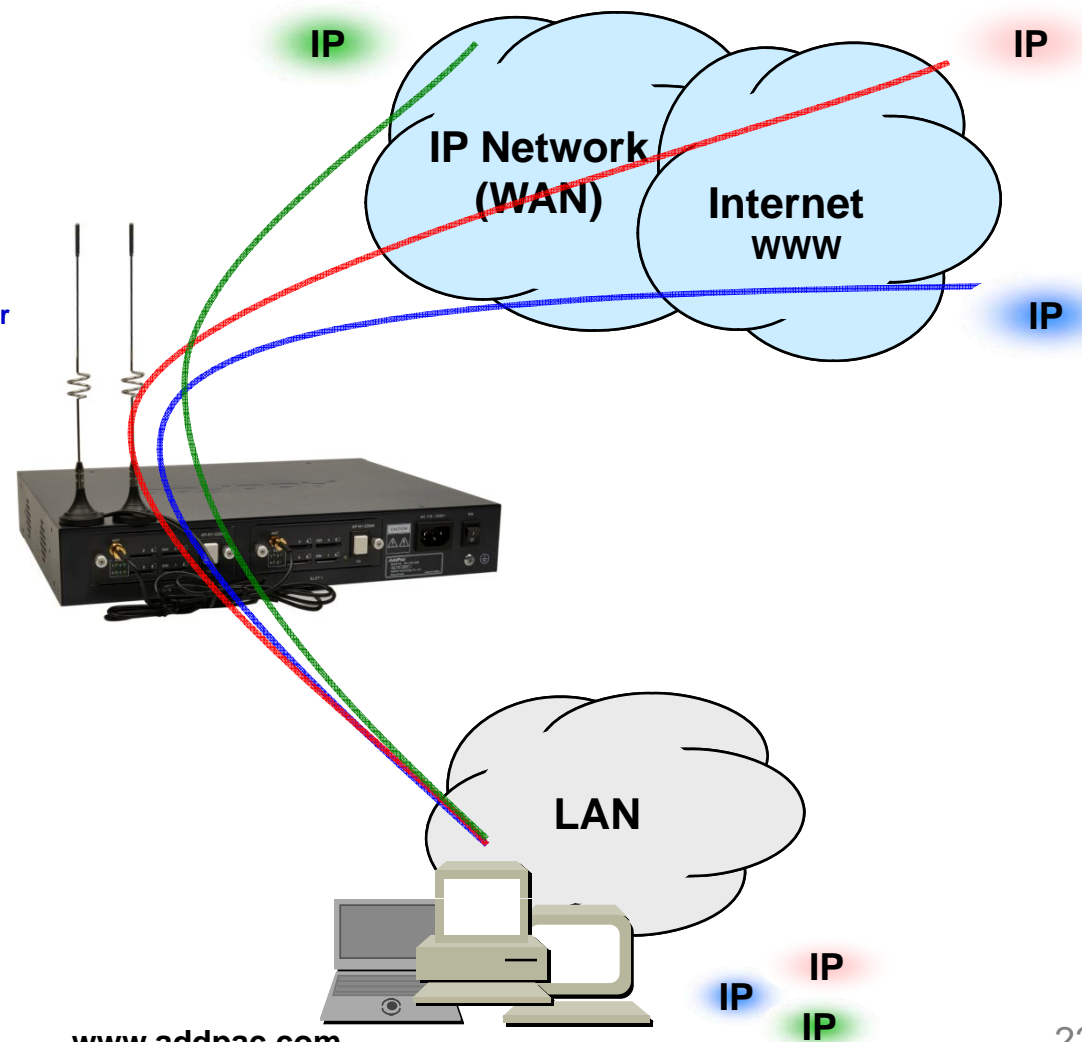

# Network Management

## AP-GS1500 Multi-Port GSM Gateway

- **SNMP**
  - Standard Simple Network Management Protocol( SNMP) Agent support
  - MIB v1 and v2 Support
- **Web-based Management**
  - Smart Easy Setup
  - Standard Voice Interface
  - Standard PSTN Back-up Interface
- **Watch-dog Function**
  - Hardware, Software watch-dog services
- **Remote Management**
  - Telnet
  - Rlogin
- **Auto Upgrade Service**
  - HTTP server based APOS image and configuration file auto-upgrade support
- **Batch Job Function**
  - Text based script downloading
- **Interoperable with AP-VPMS Service**
  - AddPac VoIP Plug & Play Management System (AP-VPMS)

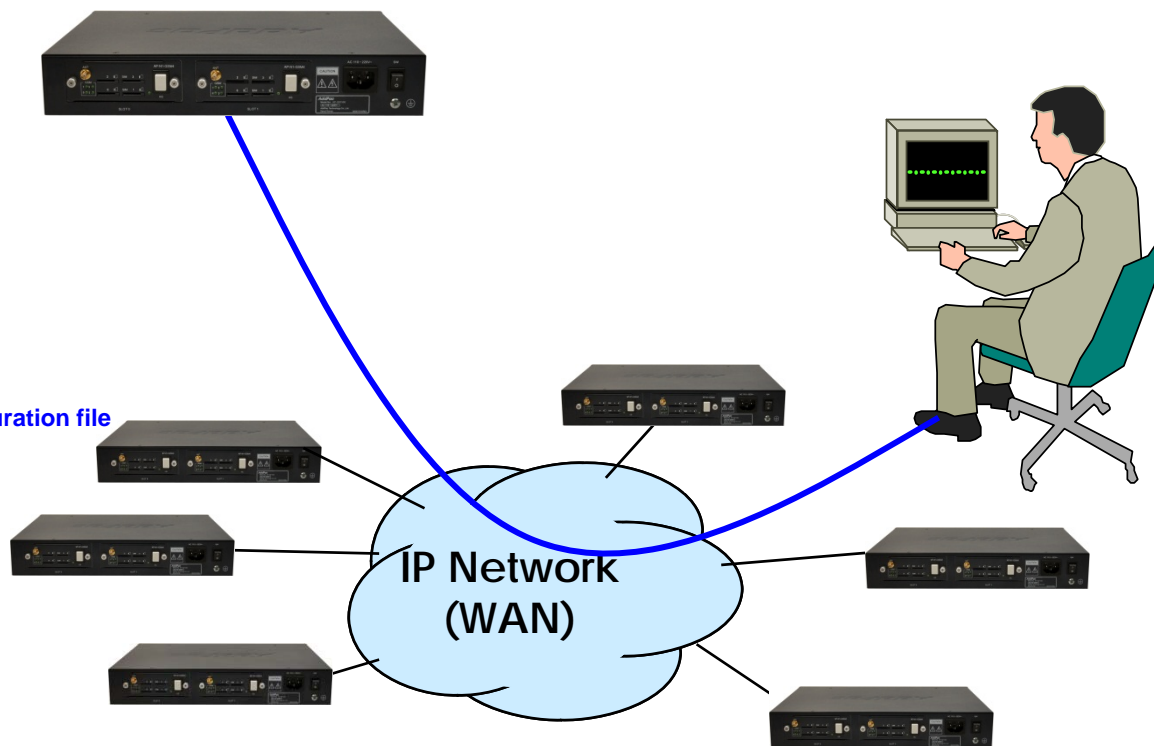

# Smart Web Manager

## AP-GS1500 Multi-Port GSM Gateway

- **System Configuration**
  - Network Setup, Language, NAT, PPTP, NTP
- **Basic Configuration**
  - Protocol, SIP Server , FXS Extension, GSM Extension
  - DTMF/CODEC, VoIP Dial Plan, GSM Dial Plan, Static Routing, Hot Line
- **Advanced Configuration**
  - Gain/CID, GSM PINs, FAX, Service, Filtering, Security
  - GSM Web Callback, GSM Callback
- **Miscellaneous Configuration**
  - Call Status, System Status, Alarm Status, GSM Status
  - Call Log, System Log, Ping, BTS Selection, GSM BTS Info
- **LCR(Least Cost Routing)**
  - Black & White List, Time Interval, Tariff Group, LCR Test
- **SMS**
  - Inbox, SMS New Message



# Smart Web Manager : Main Page Layout

## AP-GS1500 Multi-Port GSM Gateway

**Main Menu**  
For easy system setup, provide the various menu and category

- System
  - Network Setup
  - Language
  - NAT
  - PPTP
  - NTP
- Basic
  - Protocol
  - Server SIP
  - SIP Registration
  - FXS Extension
  - GSM Extension
  - DTMF/CODEC
  - VoIP Dial Plan
  - GSM Dial Plan
  - Static Route
  - Hot Line
- Advanced
  - Gain & CID
  - GSM PINs
  - Fax
  - Service
  - Filtering
  - Security
  - SNMP
  - WEB Callback
  - GSM Callback

**Tool Bar**  
Provide frequently used tools like as System Update, Configuration Backup, Initialization, Restart, Telnet

**System Information**

H/W Version	2.0
SW Version	8.00d
MAC Address	0002.a400.0000
VoIP Protocol	SIP
Voice Interface Module	G(2)S(2)
Registration Status	Registered
Supported Codec List	
Network Information	Static 172.16.9.16
WAN LINK Status	100Mbps FULL Duplex Link UP
LAN LINK Status	Link Down
Current Time	Fri Jan 1 01:49:57 2010
System Startup Time	Fri Jan 1 00:00:00 2010
	0 days 01:49:57
	0

**Information**  
Display the current system version and status summary

AddPac Technology  
Model : GS1002\_G2  
H/W Version : 2.0  
S/W Version : 8.00d  
Smart Web Version : 0.4  
Smart Web Build : Mar 24 2010  
Voice Interface  
G(2)S(2)  
Protocol : SIP  
Status : Registered  
CurrentCalls: 0 Call  
Network : Static 172.16.9.16  
Mac Address: 0002.a400.0000  
Unread Message:  
P0:0(0)  
P0:1(0)

**Description**  
Display the help message if you move mouse over main menu

**Workspace**  
Workspace for detailed action

# Smart Web Manager : System – Network Setup

## AP-GS1500 Multi-Port GSM Gateway

**Host Name**  
Create a representative name for the site to be installed

**Static IP**  
This is static IP mode. Specify the addressed IP from the service provider

**PPPoE**  
This is ADSL mode. This mode is used for addressing IP though authentication from the modem. At this time, the modem must be configured in a way that the device can be authenticated.

**DHCP**  
This is dynamic IP mode which is set at default. The IP can be addressed from the external DHCP server.

**VLAN**  
Configure VLAN mode and ID.

**WAN Link**  
Controls and recognizes WAN port. Specify the connection speed of WAN port. connection automatically.

**MAC**  
Change MAC address of WAN interface. Without address entry, use the basic MAC Address.

**Network Setup**

Hostname: GS1002

Static IP

IP Address: 172.16.9.16 (A.B.C.D)

Network Mask: 255.255.0.0 (A.B.C.D)

Default Router: 172.16.1.1 (A.B.C.D)

DNS Server: [ ] Primary DNS Server

[ ] Secondary DNS Server

PPPoE(ADSL)

Username: [ ]

Password: [ ]

DHCP

VLAN

ID: [0]

Auto

Speed:  100  10

Duplex:  full  half

WAN Link Control:  Manual

MAC(Hardware) Address: [ ]-[ ]-[ ]-[ ]-[ ]-[ ]

Apply

**Information**

AddPac Technology  
Model : GS1002\_G2  
H/W Version : 2.0  
S/W Version : 8.00d  
Smart Web Version : 0.4  
Smart Web Build : Mar 24 2010  
Voice Interface  
G(2)S(2)  
Protocol : SIP  
Status : Registered  
CurrentCalls : 0 Call  
Network : Static 172.16.9.16  
Mac Address : 0002.a400.0000  
Unread Message:  
P0:0(0)  
P0:1(0)

**Description**

This command sets up WAN port. The static IP address is to be assigned to the WAN port. The static IP address can be changed. MAC Address change can be used only when necessary. It is recommended to use the address created by the user not the address of the device

**UnRead SMS Messages**

# Smart Web Manager : Basic – GSM Extension

## AP-GS1500 Multi-Port GSM Gateway

**Port Information**  
voice port type & physical port

**GSM Extension**  
Configure GSM phone-number for receiving a call  
(usually 'T' is used for each port)

**GSM Extension with Translation**  
Used to GSM callback  
- The Received CID is not real serving number.  
- The specified translation rule is applied.

**Smart Web Manager**  
www.addpac.com

**System**

- Network Setup
- Language
- NAT
- PPTP

**Advanced**

- Gain & CID
- GSM PINs
- Fax
- Service
- Filtering
- Security
- SNMP
- WEB Callback
- GSM Callback

**Miscellaneous**

- Call Status
- System Status
- Alarm Status
- GSM Status
- Call Log
- System Log
- Ping
- BTS Selection
- GSM BTS Info

**GSM Extension**

**Port Information**

Port	P0	P1	P2	P3
SLOT0	GSM	GSM	FXS	FXS

**GSM Extension Configuration**

Index	Port	Numbers	Preference	HuntStop	Select
0	0/0	T	0	X	<input type="checkbox"/>

**GSM Extension with Translation**

Port	Destination Pattern	Digits to Insert	Number of Digits to Delete
P0:0	33	8	1
P0:1			0

**Information**

AddPac Technology  
Model : GS1002\_G2  
H/W Version : 2.0  
S/W Version : 8.00d  
Smart Web Version : 0.4  
Smart Web Build : Mar 24 2010  
Voice Interface  
G(2)S(2)  
Protocol : SIP  
Status : Unregistered  
CurrentCalls : 0 Call  
Network : Static 172.16.9.16  
Mac Address: 0002.a400.0000  
Unread Message:  
P0:0(0)  
P0:1(0)

**Description**

Set up for using GSM port to extension number (forwarding No)

# Smart Web Manager : Miscellaneous – GSM BTS Info

## AP-GS1500 Multi-Port GSM Gateway

Smart Web Manager

www.addpac.com

⚙️
📶
🖨️
📄

- System
- Network Setup
- Language
- NAT
- PPTP
- NTP

- Basic
- Protocol
- Server SIP
- SIP Registration
- FXS Extension
- GSM Extension
- DTMF/CODEC
- VoIP Dial Plan
- GSM Dial Plan
- Static Route
- Hot Line

- Advanced
- Gain & CID
- GSM PINs
- Fax
- Service
- Filtering
- Security
- SNMP
- WEB Callback
- GSM Callback

- Miscellaneous
- Call Status
- System Status
- Alarm Status
- GSM Status
- Call Log
- System Log
- Ping
- BTS Selection
- GSM BTS Info

### GSM BCCH Cell Information

PORT 0:0

PORT 0:1

**BCCH Cell Information**  
Shows serving cell information ( center circle) and neighboring cell information.  
 \* LAC : Location Area Code  
 \* CI : Cell ID  
 \* BSIC : Basic Station ID Code  
 \* BCCH : Broadcast Control Channel  
 \* RSSI : Receiver Signal Strength

Information

AddPac Technology  
 Model : GS1002\_G2  
 HW Version : 2.0  
 SW Version : 8.00d  
 Smart Web Version : 0.4  
 Smart Web Build : Mar 24 2010  
 Voice Interface  
 G(2)S(2)  
 Protocol : SIP  
 Status : Unregistered  
 CurrentCalls : 0 Call  
 Network : Static 172.16.9.16  
 Mac Address: 0002.a400.0000  
 Unread Message:  
 P0:0(0)  
 P0:1(0)

Description

Verify GSM wireless signal status

# Security Management

## AP-GS1500 Multi-Port GSM Gateway



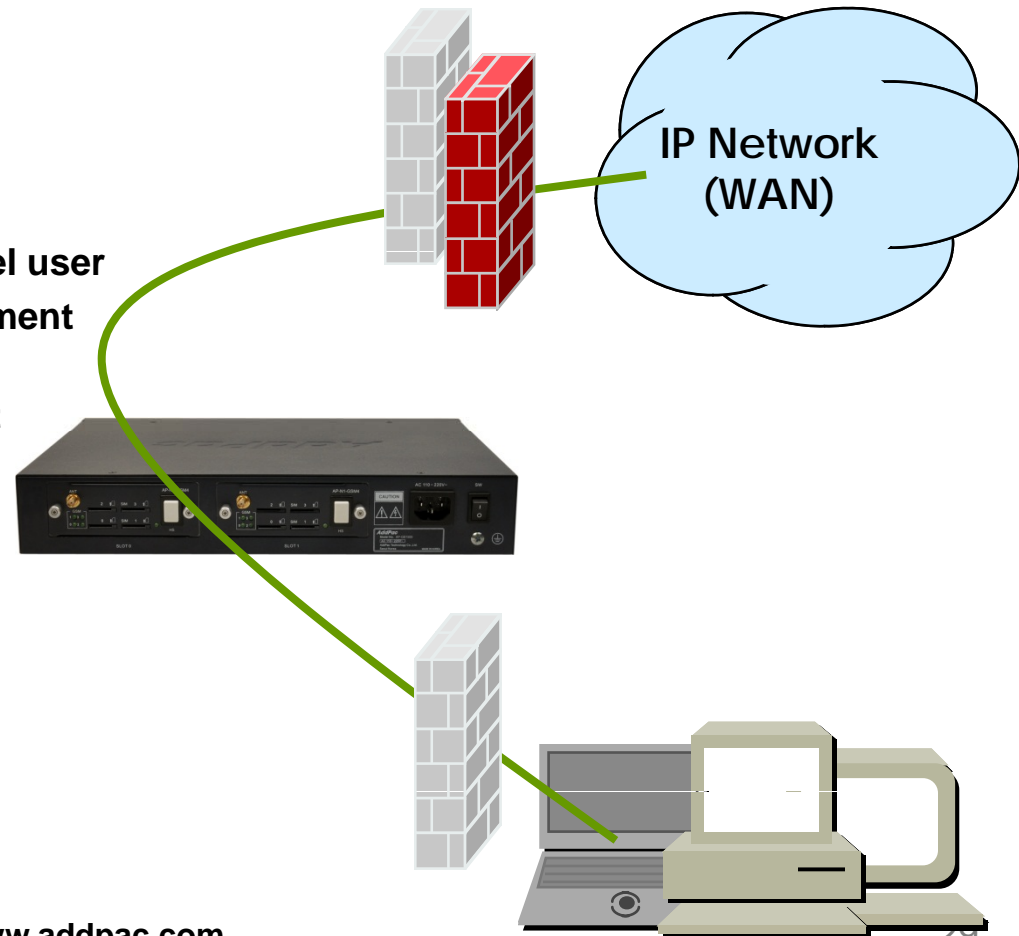

- IP packet filtering
- IP access list
- User authentication function
  - Password Authentication Protocol (PAP)
  - Challenge Handshake Authentication Protocol (CHAP)
- Enable/Disable specific protocols
- Auto-square connect of Telnet session
- Account Management function for multi-level user
- SNMP/TELNET/FTP/HTTP/TFTP port assignment function
- SNMP/TELNET/FTP access list management
- Boot mode security checking function



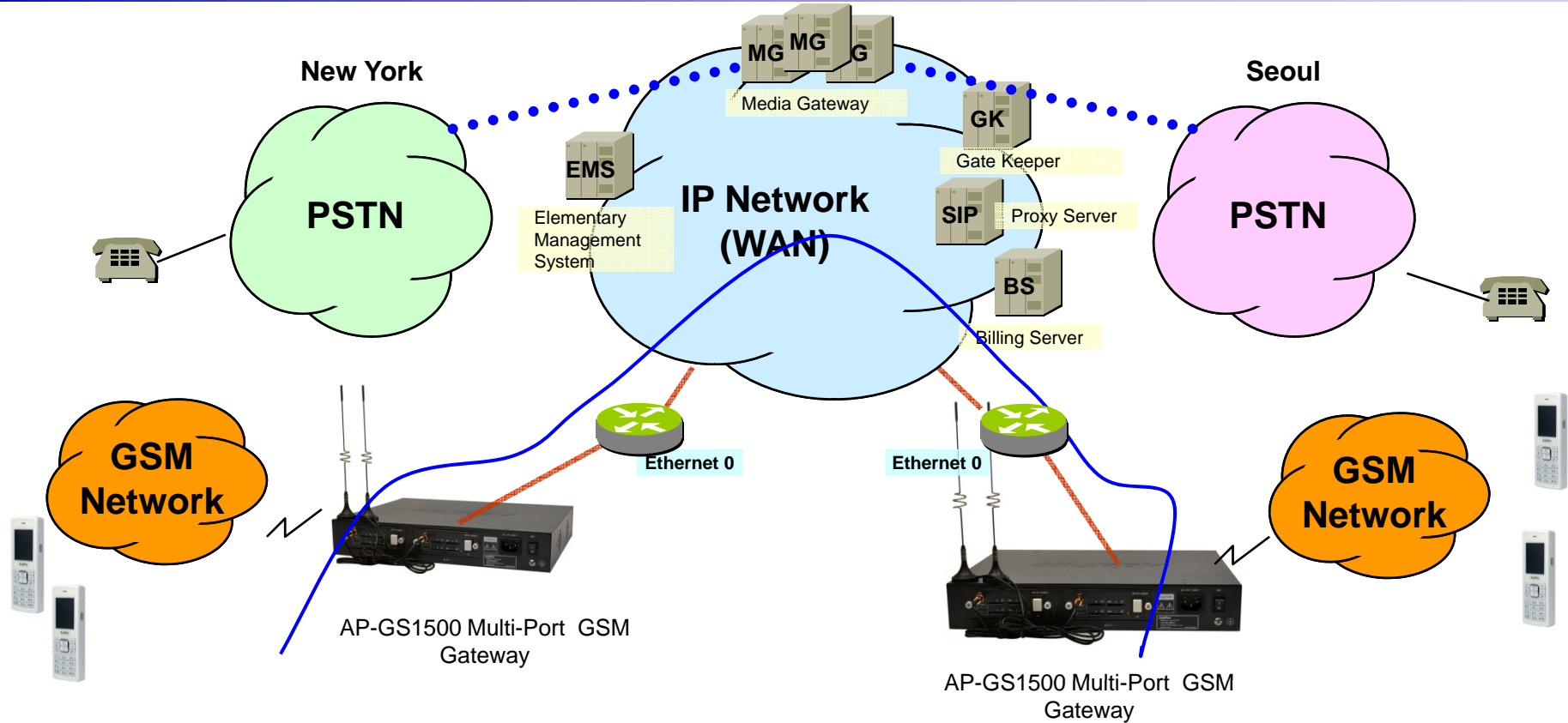

# Standard Application

## AP-GS1500 Multi-Port GSM Gateway



-  FXS Analog Voice Interface
-  FXO Analog Voice Interface
-  Voice+Data, Ethernet or WAN Interface
-  TRUNK n x E1 Voice Interface for PSTN Inter-working

-  Leased Line/ATM/Frame-Relay/IP Router, xDSL/Cable Modem, etc.
-  AddPac AP-GS1500 Multi-Port GSM Gateway
-  Analog Phone

# Ordering Information

- **AP-GS1500 GSM Gateway Hardware**
  - AP-GS1500 GSM Gateway Main Body (Two(2) Module Slots)
  - RISC Microprocessor with High-end Programmable DSP Architecture
  - 2-port 10/100Mbps Fast Ethernet(RJ45)
  - 1-Port RS232C Console Interface(RJ45)
  - Option Module : AP-N1-GSM4, AP-N1-FXS8, AP-N1-FXO8,etc
  - Including Network Cable, Antenna & Power Supply Cable, etc.
- **Built-in APOS Internetworking Software for AP-GS1500**
- **Including 1 Year Hardware Warranty**
- **Product Documents**
  - Install and Operation Guide (PDF)
- **Pricing**
  - AddPac Technology Regional Sales Manager
  - Authorized Sales and Marketing Representatives
  - Please Contact [www.addpac.com](http://www.addpac.com)

# GSM Gateway Series

# Thank you!

**AddPac Technology Co., Ltd.**  
Sales and Marketing

Phone +82.2.568.3848 (KOREA)

FAX +82.2.568.3847 (KOREA)

E-mail [sales@addpac.com](mailto:sales@addpac.com)