



# AP-LMR2000

## LMR(Land-to-Mobile Radio) Gateway

High Performance LMR Gateway Solution

## Product Overview



**AddPac**

**AddPac Technology**

Sales and Marketing

[www.addpac.com](http://www.addpac.com)

# Contents

## AP-LMR2000 LMR Gateway

- Product Overview
- Hardware Specification
- APOS Technology
- LMR(Land-to-Mobile Radio) Service
- RoIP System Message Flow Diagram
- TLS/SRTP Secure Service
- VoIP (Voice over IP) Service
- Advanced QoS Features
- Network Protocols
- Network Management
- Security Management
- Application Service
- Ordering Information

# Product Overview

## AP-LMR2000 LMR Gateway

- Radio over IP Service Support
- Radio Systems(Motorola, etc) are Extended to IP Network
- High Performance RISC & Programmable DSP Architecture
- Two(2) 10/100Mbps Fast Ethernet (IP Share ,etc)
- High Performance LAN-to-LAN Routing Capability
- Two(2) Module Slots for Radio Interface (E&M, etc)
- VoIP Codec : G.711/G.726/G.723/G.729, VAD, etc
- Powerful Network Protocols (PPPoE, DHCP, Static Routing, etc)
- IPv4/IPv6 Dual Stack Support
- SIP/H.323 Dual Concurrent Signaling Protocols
- TLS/SRTP VoIP Secure Protocol Support (AES, 3DES, etc)
- Firmware Upgradeable Architecture
- Advanced Voice QoS Mechanism
- Powerful Web based Management
- RS232C Port Support for Command Line Interface

# Product Highlights

AP-LMR2000 LMR Gateway

## LMR(Land-to-Mobile Radio) Gateway Solution

State-of-art Signaling  
H.323, SIP  
Concurrent Dual Stack

High Performance  
Radio over IP Service

Excellent Voice Quality  
G.729/G.723/G726/G711

High Performance RISC CPU  
+ Programmable DSP

Two(2) Module  
Slot for Radio Interface,  
Internal Power Supply

Broadband IP Networking  
With dual 10/100Mbps  
Fast Ethernet

APOS™Technology  
Firmware Upgradeable Architecture

High Performance  
LAN-to-LAN Packet Routing  
Processing

Powerful Network Protocol  
Support

Powerful Trouble Shooting &  
Debugging Feature Support

Advanced Voice  
Traffic QoS Mechanism

**AddPac**

[www.addpac.com](http://www.addpac.com)

# APOS Technology

AP-LMR2000 LMR Gateway

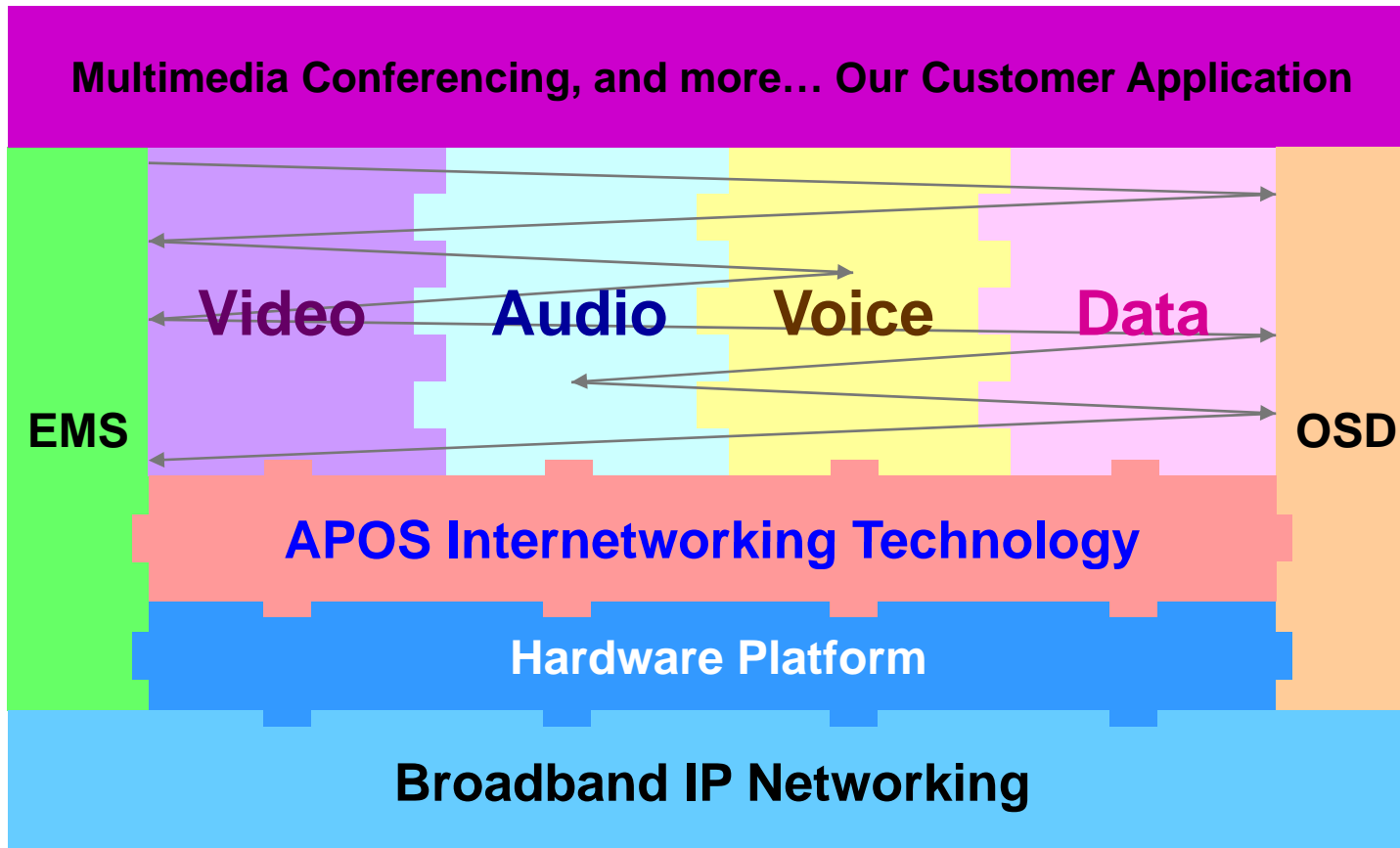

- APOS : AddPac Internetworking Operating System
- OSD : On- Screen Display
- EMS : Element Management System

# Hardware Specification

AP-LMR2000 LMR Gateway

RISC  
CPU

High-end  
DSP

- RISC Microprocessor Computing Power
- Main Chassis
  - Network Interface
    - Two(2) 10/100Mbps Fast Ethernet
    - One(1) RS-232C Console (RJ45)
  - Two(2) Radio Module Slots for E&M, etc
  - Internal Power Supply

# Hardware Specification

## AP-LMR2000 LMR Gateway

### AP-LMR2000 Back Side

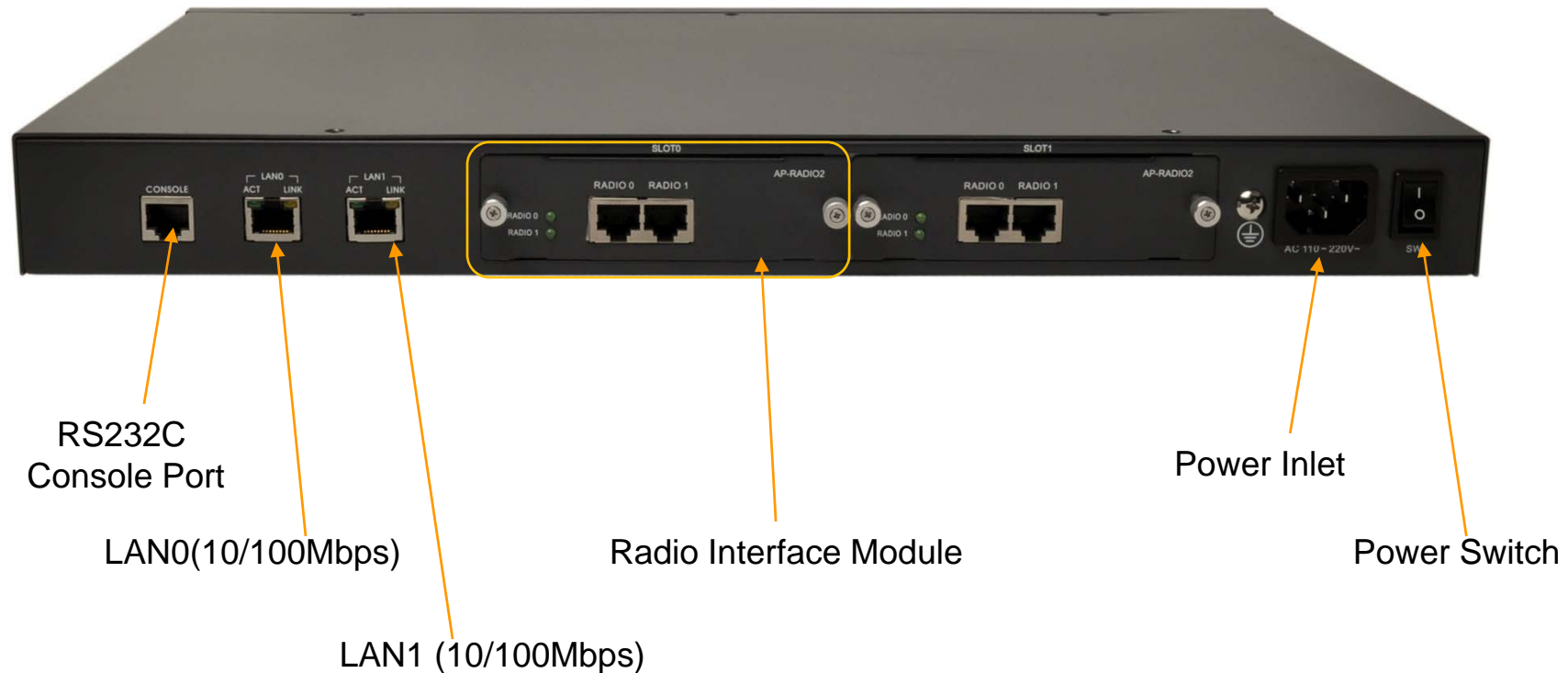

# Hardware Specification

AP-LMR2000 LMR Gateway

Example : AP-RADIO2 Interface Module for Radio Interworking





# Hardware Specification

## AP-LMR2000 LMR Gateway

### Example : E&M Interface for Radio Interworking

Lead Name	Pin	Description
E (Ear or Earth)	Pin 7	Signal wire asserted by the router toward the connected device. Typically mapped to the push-to-talk (PTT) lead on the radio.
M (Mouth or Magnet)	Pin 2	Signal wire asserted by the router toward the connected device. Typically mapped to the push-to-talk (PTT) lead on the radio.
SG (Signal Ground)	Pin 8	Used on E&M signaling Types II, III, and IV.
SB (Signal Battery)	Pin 1	Used on E&M signaling Types II, III, and IV.
<b>Two-Wire Mode</b>		
T1/R1 (Tip-1/Ring-1)	Pin 4,5	In two-wire operation, the T1/R1 leads carry the full-duplex audio path.
<b>Four-Wire Mode</b>		
T/R (Tip/Ring)	Pin6,3	In a four-wire operation configuration, this pair of leads carries the audio in from the radio to the router and would typically be connected to the line out or speaker of the radio.
T1/R1 (Tip-1/Ring-1)	Pin5,4	In a four-wire operation configuration, this pair of leads carries the audio out from the router to the radio and would normally be connected to the line in or microphone on the radio

# LMR Service

## AP-LMR2000 LMR Gateway

- LMR system overview
  - A LMR(Land Mobile Radio) system is a collection of portable and stationary radio units designed to communicate with each other.
  - LMR is deployed wherever organizations need to have instant communication between geographically dispersed and mobile personnel.
  - Typical LMR system users are public safety organizations (ex: police departments, fire departments, etc).
  - The systems are extended the range of communications by repeaters.
  - The systems are required interoperability with IP network.

# LMR Service

## AP-LMR2000 LMR Gateway

- **AddPac RoIP Solution Features**
  - LMR Gateway(AP-LMR2000) joins the LMR systems to the IP network through open SIP standard and RTP.
  - The radios are connected to LMR gateway through AddPac radio interface (reference LMR signal).
  - AddPac IP PTT terminals (AP-IP230, AP-IP300 IP Phones, AP-WP100 WiFi-Phone, etc) support the traditional radio user interface(PTT).
  - AddPac IP PTT terminals easy PTT group management user interface.
  - IP-PBX support call management, PTT group management, PTT control and various additional service.
  - PTT Server(AP-PTS3000) support powerful media data relay, broadcasting, multicasting and PTT group management.
  - RoIP Solution supports emergency and group PTT service.

# LMR Service Examples

## AP-LMR2000 LMR Gateway

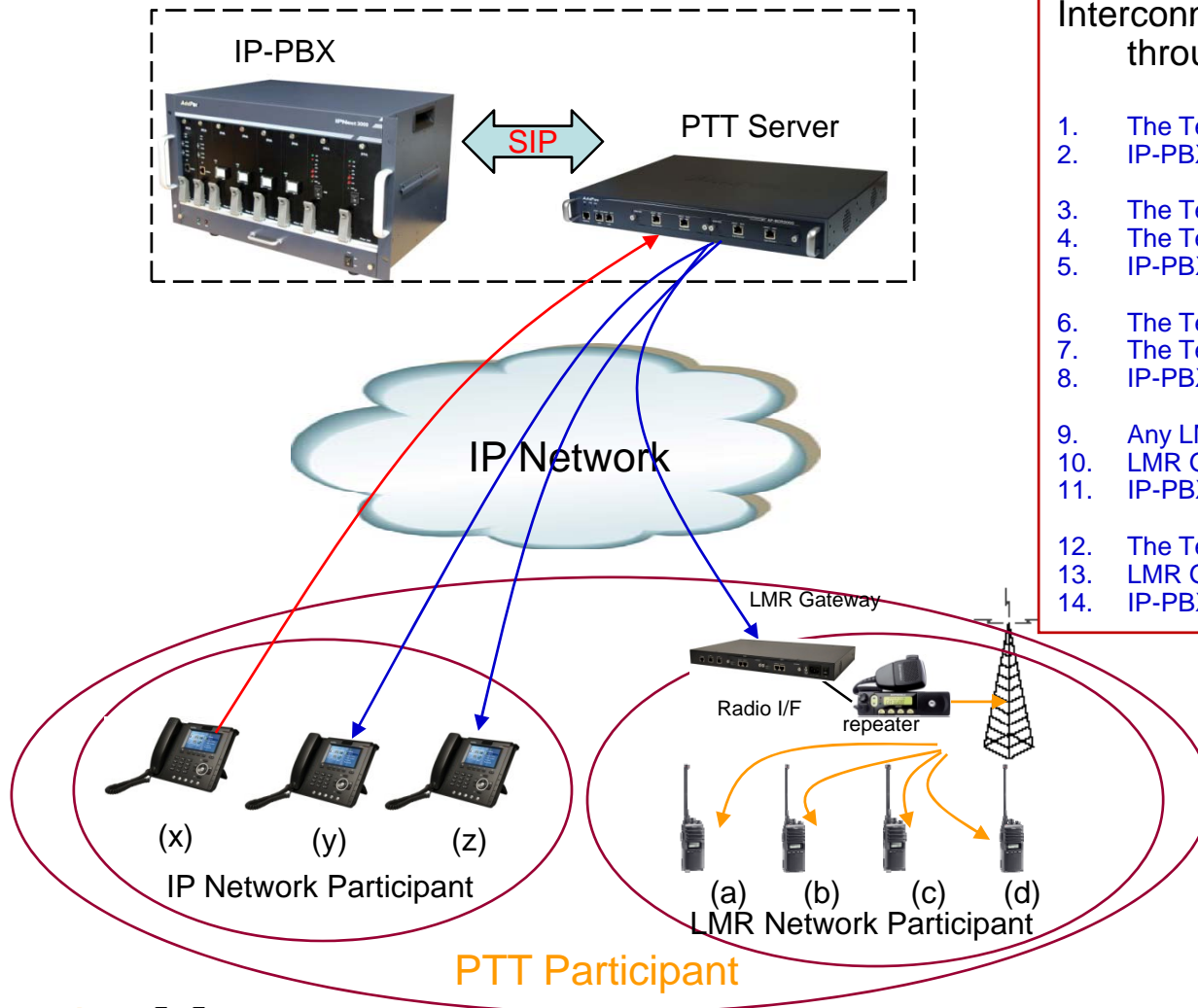

- Interconnection LMR systems to IP network through AddPac RoIP solution.
1. The Terminal(x) originate a PTT conference.
  2. IP-PBX send invitation message to all participant.
  3. The Terminal(x) presses the 'floor button' to talk.
  4. The Terminal(x) send a 'floor-request' message.
  5. IP-PBX and PTT servers control media-relay.
  6. The Terminal(x) releases the 'floor button'.
  7. The Terminal(x) send a 'release-request' message.
  8. IP-PBX and PTT servers control media-relay.
  9. Any LMR Terminal(a~d) presses the 'floor button' to talk.
  10. LMR Gateway send a 'floor-request' message.
  11. IP-PBX and PTT servers control media-relay.
  12. The Terminal(a) releases the 'floor button'.
  13. LMR Gateway send a 'release-request' message.
  14. IP-PBX and PTT servers control media-relay.

<span style="color: red;">—</span>	RTP (floor)
<span style="color: blue;">—</span>	RTP(Participant)
<span style="color: yellow;">—</span>	Radio(Participant)

# RoIP System Message Flow

## AP-LMR2000 LMR Gateway

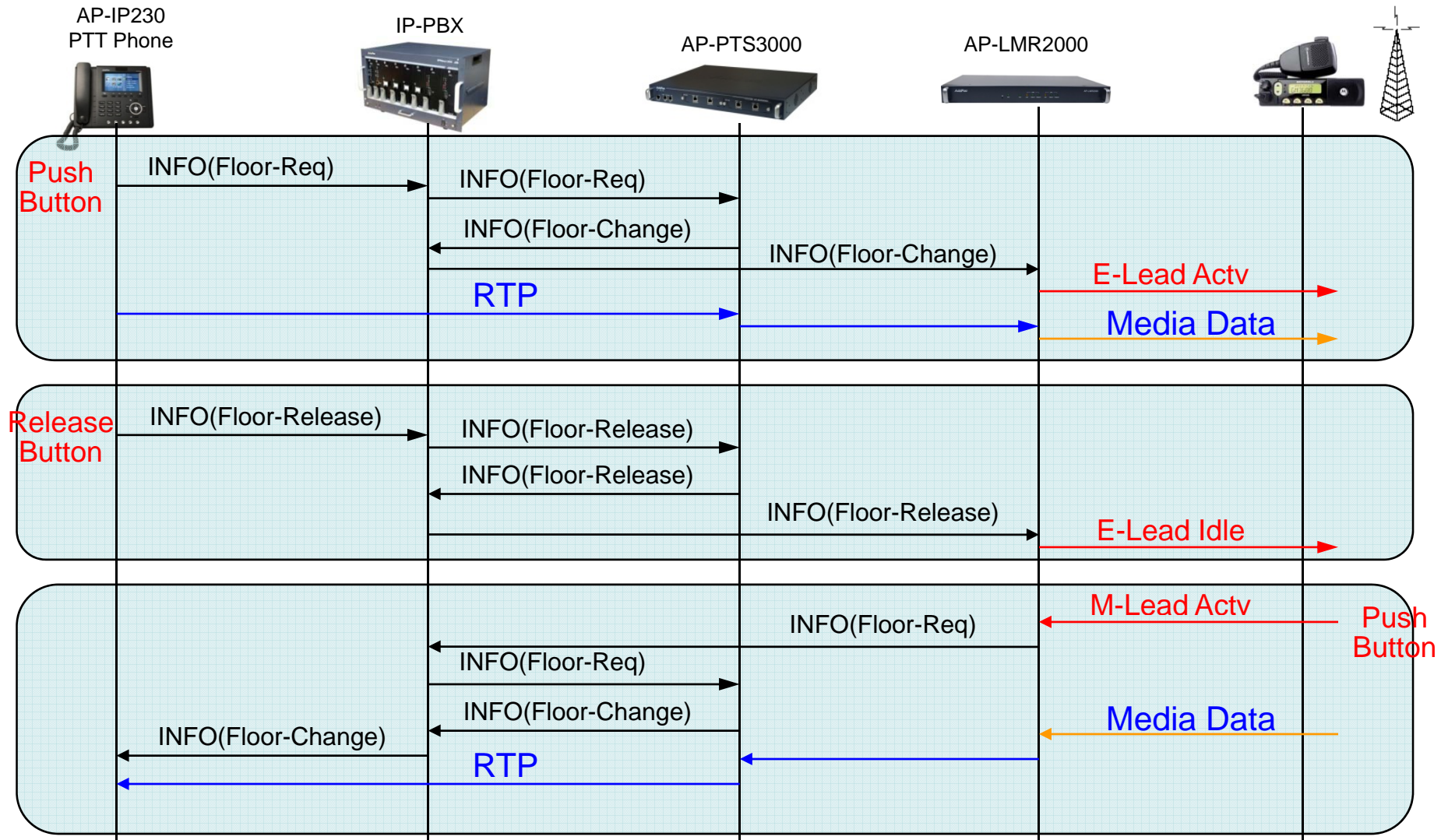

# VoIP (Voice over IP) Service

AP-LMR2000 LMR Gateway

- **H.323, SIP Dual Stack**
- **H.323**
  - ITU-T Standard H.323 v3 Support
  - Support H.245 Tunneling
  - Including H.235 Security Features
- **SIP**
  - IETF RFC3261 or RFC2543 SIP Standard

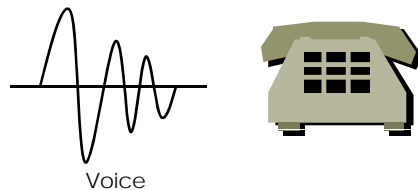
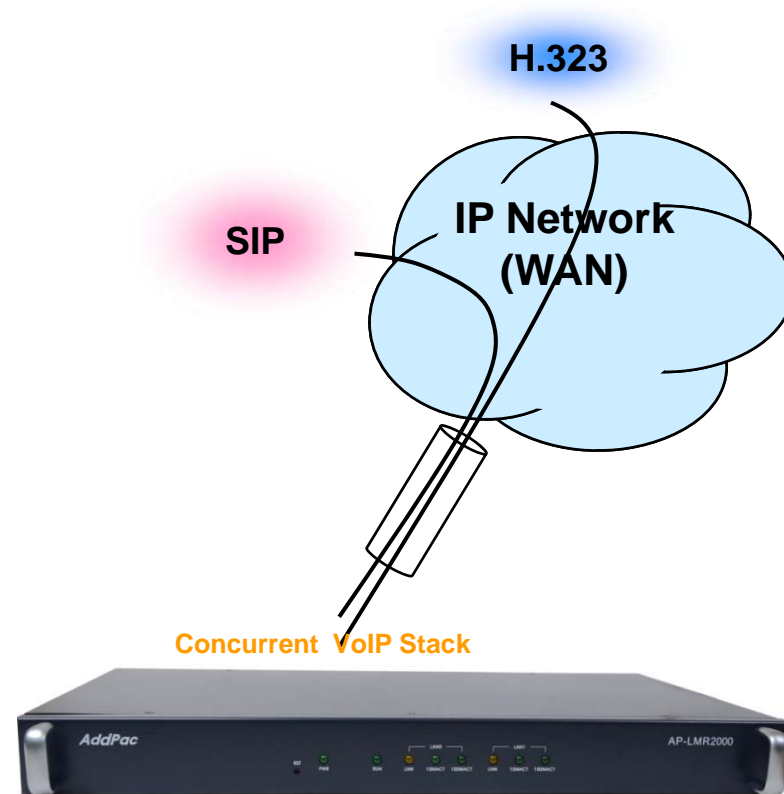

# VoIP (Voice over IP) Service

## AP-LMR2000 LMR Gateway

- **H.323**

- Fast connect, normal connect support
- H.245 tunneling support
- Q.931 response message setting for inbound VoIP calls
- H.245 logical channel open timing selection function
- Start H.245 procedure support
- DTMF / Hook flash relay with H.245 alphanumeric / signal
- Secondary gatekeeper support
- Gatekeeper assignment according to the domain name
- Gatekeeper discovery with multicast
- Lightweight RRQ support
- Signaling TCP port assignment
- Resource threshold setting with RAI
- H.235 clear-token, crypto-token support
- canMapAlias support
- Technical prefix (supported prefix) support
- Public IP assignment in NAT environment

- **SIP**

- Gateway-based / Endpoint-based registration support
- Secondary proxy-server assignment function
- SIP signaling port change function
- SIP proxy server assignment according to the domain name
- T.38 real-time fax relay support
- DTMF relay support with RFC2833 / OPTION message
- Re-INVITE support

# VoIP (Voice over IP) Service

## AP-LMR2000 LMR Gateway

- **Voice Codec**

- G.711 A-Law, G.711 U-Law
- G.726 r16, G.726 r32
- G.729A
- G.723.1 r63, G.723.1 r53
- VAD (Voice Activity Detection) function support
- DTMF relay support (H.323, SIP, MGCP common) based on RFC2833

- **RTP**

- Redundant RTP packet transmission in case of severe packet loss
- Dynamic jitter buffer management and RPT packet jitter and loss compensation with heuristic & DSP error concealment
- Static jitter buffer setting support
- Voice frame per RTP packet number control for each codec
- In-band ring-back tone support
- Virtual ring-back tone support
- Tone parameter change support

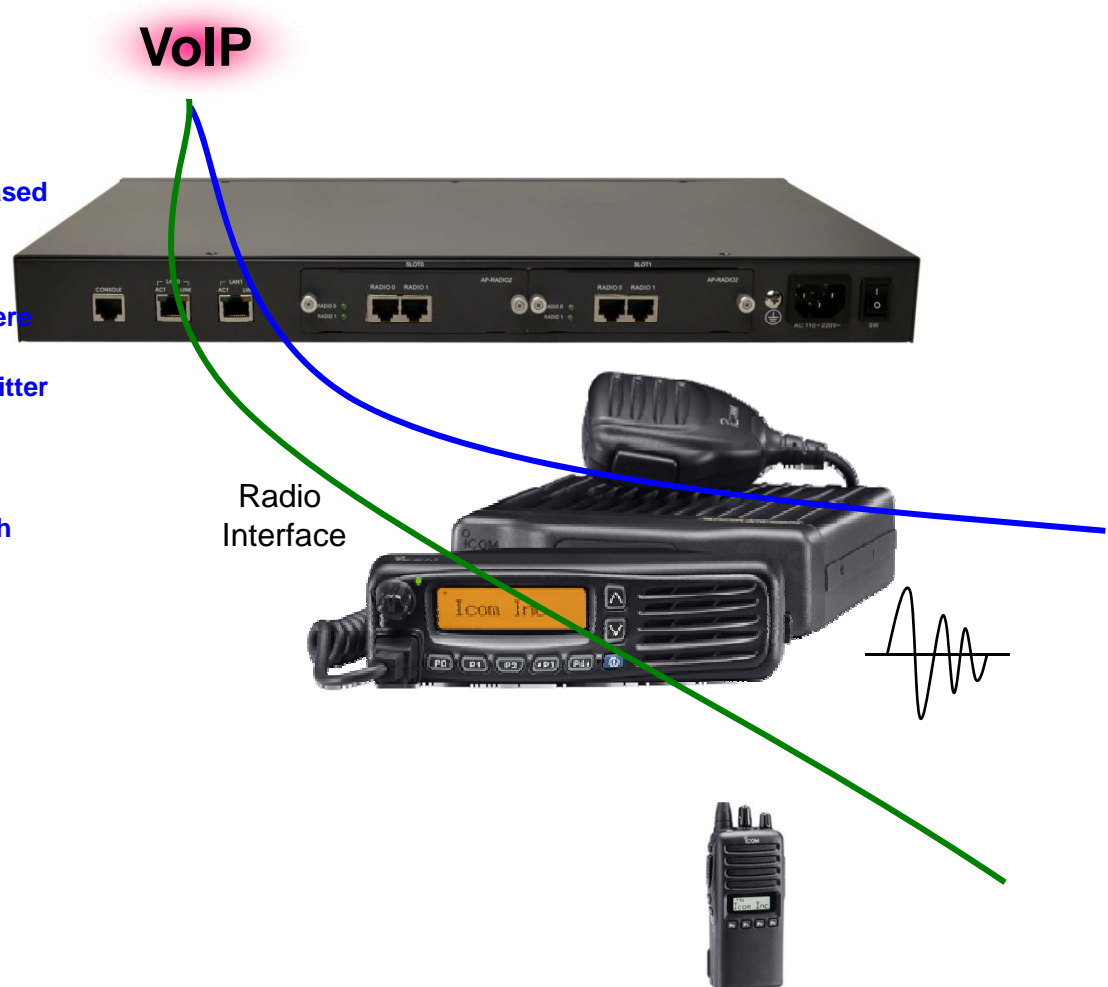



# VoIP (Voice over IP) Service

## AP-LMR2000 LMR Gateway

### • VoIP Call Controls

- Hot line connection function with PLAR (Private Line Auto Ring Down)
- Leased line emulation function
- Connection monitoring function
- Fault tolerant with Redundancy and Call Distribution among Gateways for load balancing
- Call attempt with IP address
- H.323, SIP, MGCP inbound call connection for each voice port
- Multiple E.164 setting for one voice port
- One E.164 or digit pattern can be assigned to more than one voice port
- Hunting with Longest match/ priority/ sequence/ random
- One stage call setup by Digit forwarding
- Call barring with specific digit patterns
- Calling and called number conversion for PSTN outbound calls
- PSTN rerouting in case of VoIP call attempt failure

### • VoIP Call Controls (cont.)

- Call transfer for internal calls
- Call pickup for internal calls
- Calling and called number conversion for VoIP outbound calls
- Calling and called number conversion for VoIP inbound calls
- Fax broadcasting call control

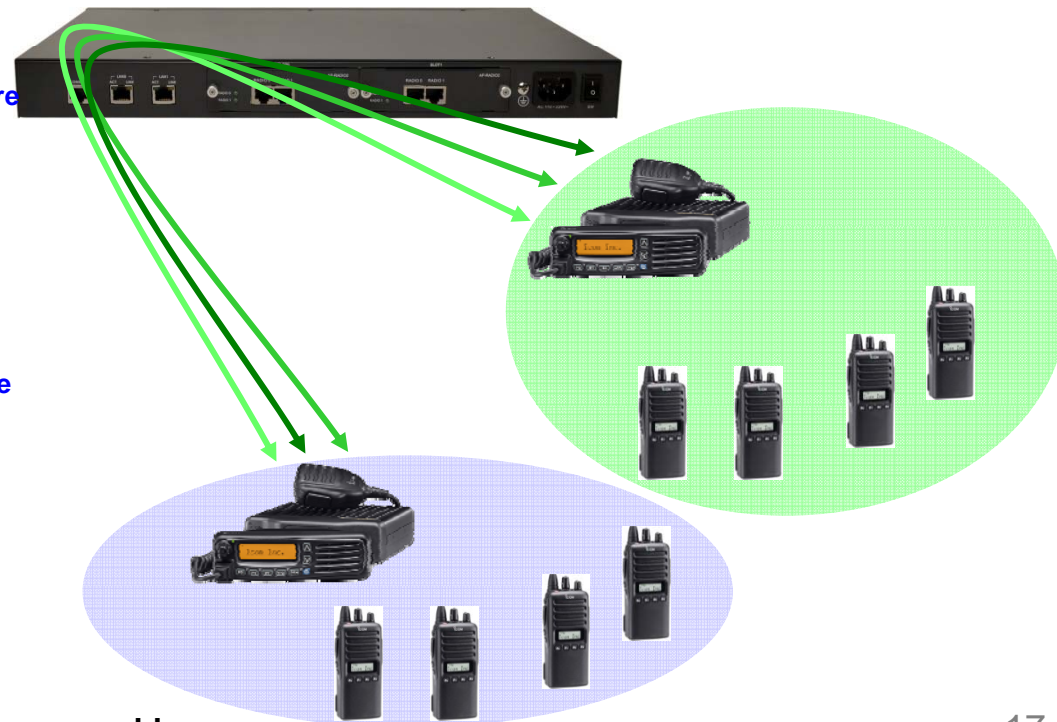

# Advanced QoS Features

## AP-LMR2000 LMR Gateway

- Enhances **Transmit** Voice QoS Features
  - Voice Traffic Priority Queuing
  - QoS Service Profiling
  - Providing Virtual Network Transmit Algorithm
  - Real-time Voice Traffic QoS Support
  - RTP Packet Transmit Interval Control
  - Supporting RTP Packet Redundancy Scheme
  - IP Header Control such as ToS, Diffserv
- Enhances **Receive** Voice QoS Features
  - Dynamic Jitter Buffer Management
  - Error Concealment
  - Support T.38 FAX Data Error Recovery Scheme

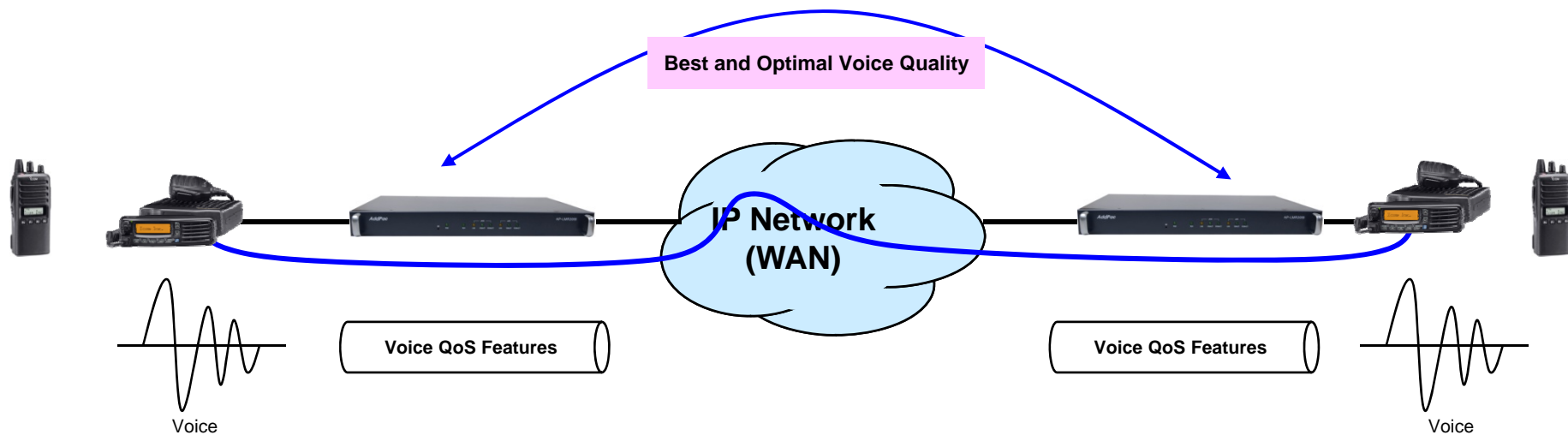

# TLS Features

## AP-LMR2000 LMR Gateway

- Support for TLS 1.1, TLS 1.0 and SSL 3.0 protocols
- Since SSL 2.0 is insecure it is not supported.
- TLS 1.2 is supported but disabled by default.
- Support for TLS extensions: server name indication, max record size, opaque PRF input, etc.
- Support for authentication using the SRP protocol.
- Support for authentication using both **X.509 certificates** and OpenPGP keys.
- Support for TLS Pre-Shared-Keys (PSK) extension.
- Support for Inner Application (TLS/IA) extension.
- Support for X.509 and OpenPGP certificate handling.
- Support for X.509 Proxy Certificates (RFC 3820).
- Supports all the strong encryption algorithms (including SHA-256/384/512), including Camellia (RFC 4132).
- Supports compression (optional).
- CRLs
  - CRL (Certificate Revocation List)
  - OCSP (Online Certificate Status Protocol, RFC2560) (via HTTP)
- Hash Algorithm : SHA-1, MD5

# SSL/TLS Protocol Layers

AP-LMR2000 LMR Gateway

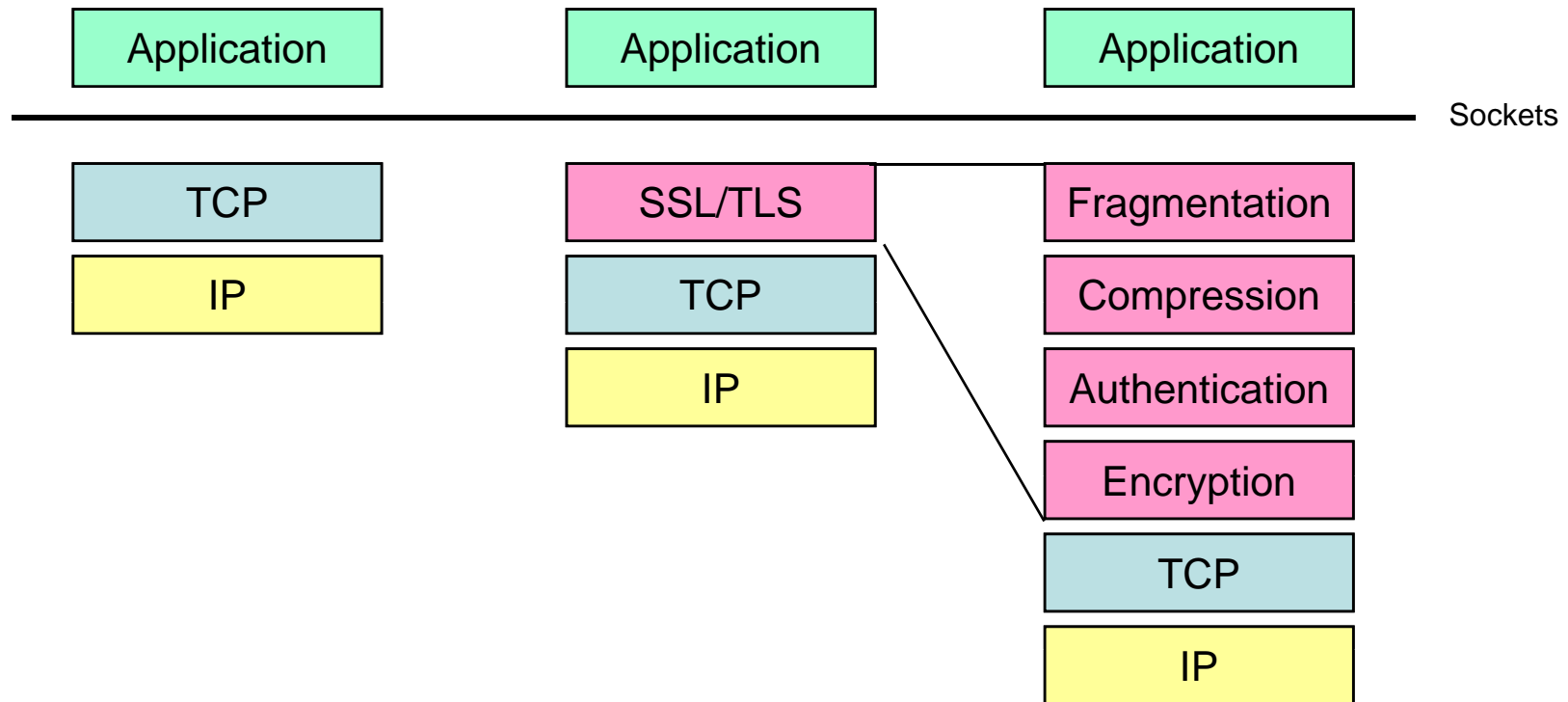

# SSL/TLS Handshake

AP-LMR2000 LMR Gateway

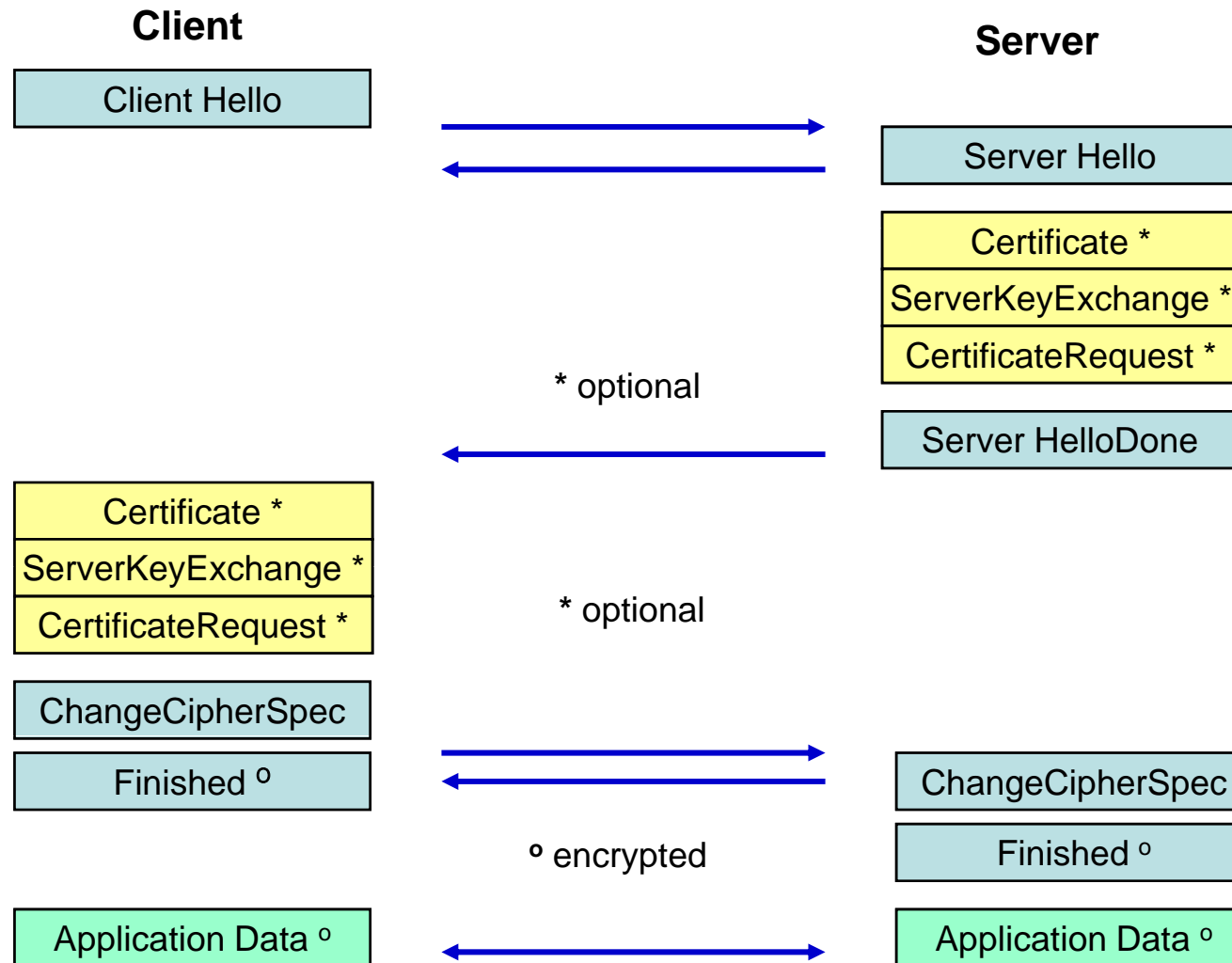

# TLS Comparison with OpenSSL

## AP-LMR2000 LMR Gateway

### • Protocol Support

	SSLv2.0	SSLv3.0	TLSv1.0	TLSv1.1	TLSv1.2
AddPac	No	Yes	Yes	Yes	Yes
OpenSSL	Yes	Yes	Yes	No	No

### • Key Exchange Algorithms

	Anon-RSA	RSA	RSA Export	DHE-RSA	DHE-DSS	SRP-DSS	SRP-RSA	SRP	PSK	ECC
AddPac	Yes	Yes	Yes	Yes	Yes	Yes	Yes	Yes	Yes	No
OpenSSL	Yes	Yes	Yes	Yes	Yes	No	No	No	No	Yes

### • Encryption Algorithms

(\*1) 40-bit encryption is insecure

	AES-256-CBC	AES-128-CBC	3DES-CBC	DES-CBC	RC4-128-CBC	RC4-40(*1)	RC2-40(*1)	Camellia
AddPac	Yes	Yes	Yes	Yes	Yes	Yes	Yes	Yes
OpenSSL	Yes	Yes	Yes	Yes	Yes	Yes	Yes	Yes

# SRTP (Secure Real-time Transport Protocol) Features

AP-LMR2000 LMR Gateway

- [RFC4568](#), Standards Track, Session Description Protocol (SDP) Security Descriptions for Media Streams
- [RFC 3711](#), Proposed Standard, The Secure Real-time Transport Protocol (SRTP)
- [RFC 3551](#), Standard 65, RTP Profile for Audio and Video Conferences with Minimal Control
- [RFC 3550](#), Standard 64, RTP: A Transport Protocol for Real-Time Applications
- [RFC 2104](#), Informational, HMAC: Keyed-Hashing for Message Authentication
- Cipher Algorithm : AES, DES(\*), 3DES(\*)

\* Support at AddPac Specific SRTP

# Network Protocols

AP-LMR2000 LMR Gateway

## Basic Network Protocols

- ARP, IPv4, TCP, UDP, ICMP, SCTP, IGMP, MLD

## Routing Protocol

- IPv4 : Static

## Service Protocol

- FTP, Telnet, TFTP, DHCP Server/Relay, SNMP Server
- CDP (Cisco Discovery Protocol)
- DNS Resolver , DDNS(nsupdate)
- Bridge
- Syslog

## IPv4 Address Configuration

- Fixed (Static)
- DHCP
- PPPoE

## Miscellaneous

- Cisco Style CLI
- Standard & Extended IPv4 Access List
- Multi-level User Account Management
- IP accounting
- STUN Client

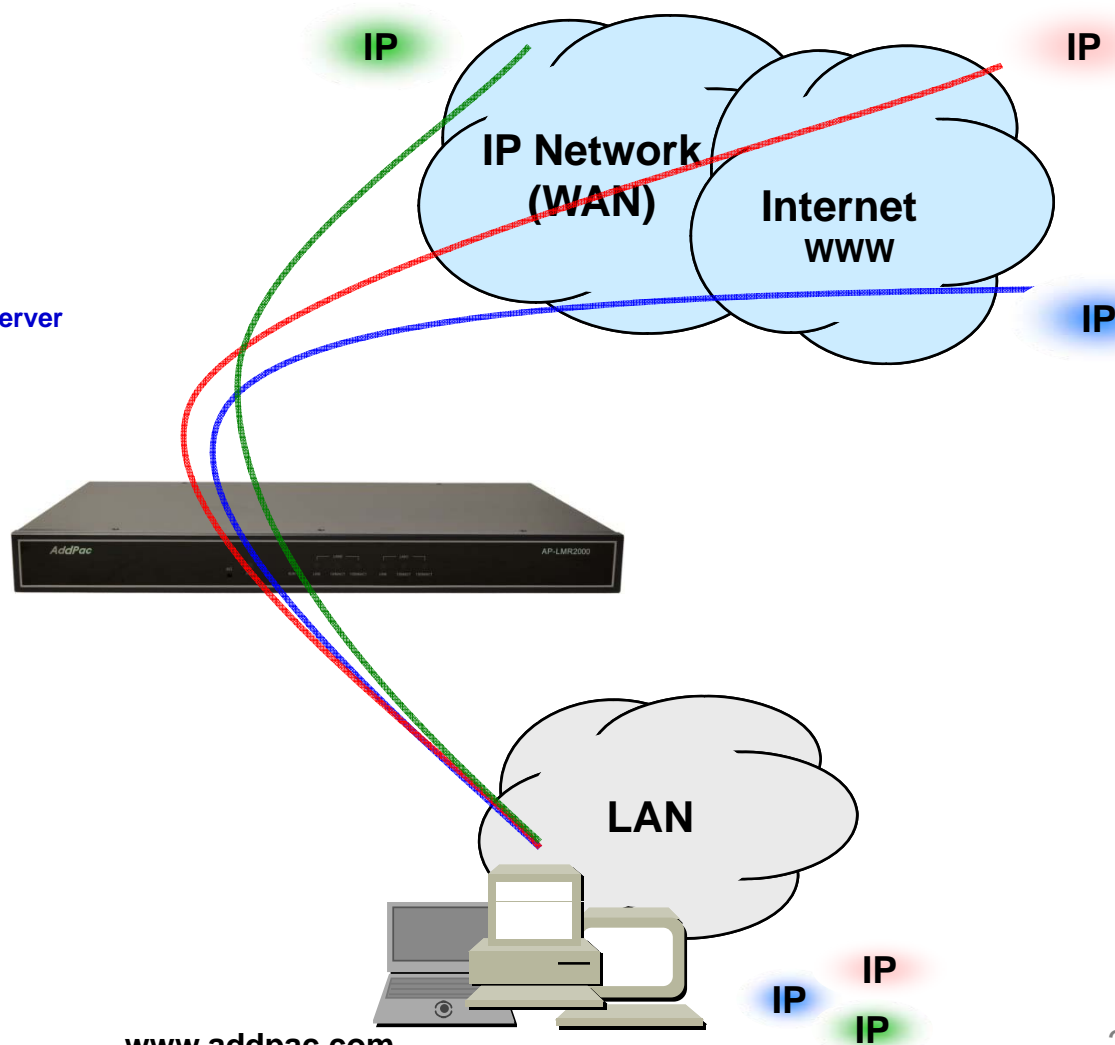



# Network Management

## AP-LMR2000 LMR Gateway

- **SNMP**

- Standard Simple Network Management Protocol( SNMP) Agent support
- MIB v1 and v2 Support

- **Web-based Management**

- Smart Easy Setup
- Standard Voice Interface
- Standard PSTN Back-up Interface

- **Watch-dog Function**

- Hardware, Software watch-dog services

- **Remote Management**

- Telnet
- Rlogin

- **Auto Upgrade Service**

- HTTP server based APOS image and configuration file auto-upgrade support

- **Batch Job Function**

- Text based script downloading

- **Interoperable with AP-VPMS Service**

- AddPac VoIP Plug & Play Management System (AP-VPMS)

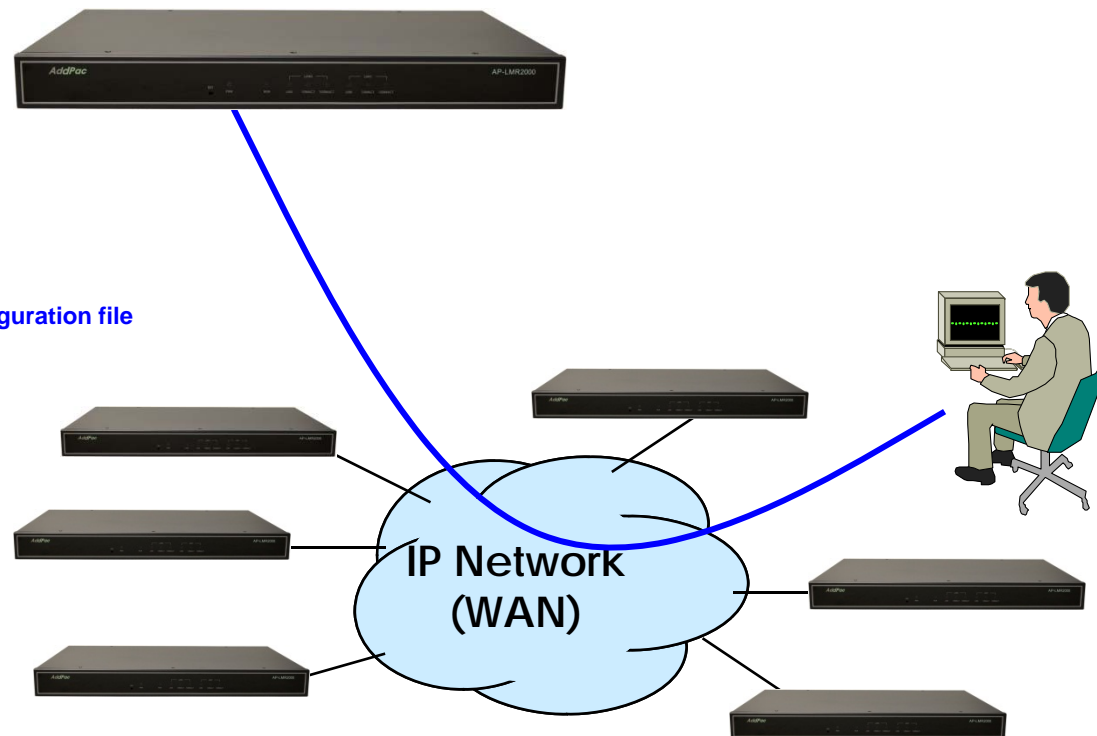

# RoIP Network Diagram

AP-LMR2000 LMR Gateway

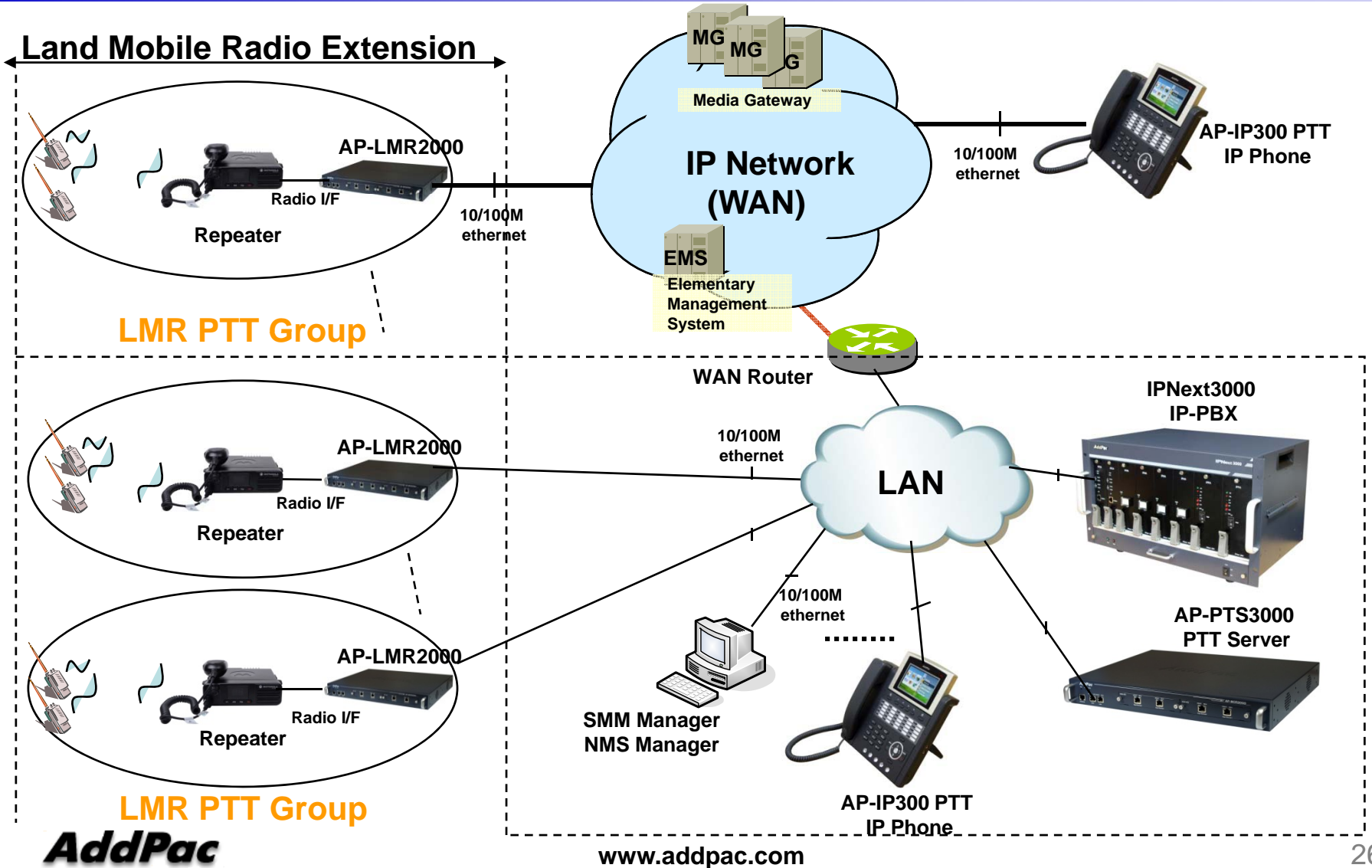

# Security Management

## AP-LMR2000 LMR Gateway

- IP packet filtering
- IP access list
- User authentication function
  - Password Authentication Protocol (PAP)
  - Challenge Handshake Authentication Protocol (CHAP)
- Enable/Disable specific protocols
- Auto-square connect of Telnet session
- Account Management function for multi-level user
- SNMP/TELNET/FTP/HTTP/TFTP port assignment function
- SNMP/TELNET/FTP access list management
- Boot mode security checking function

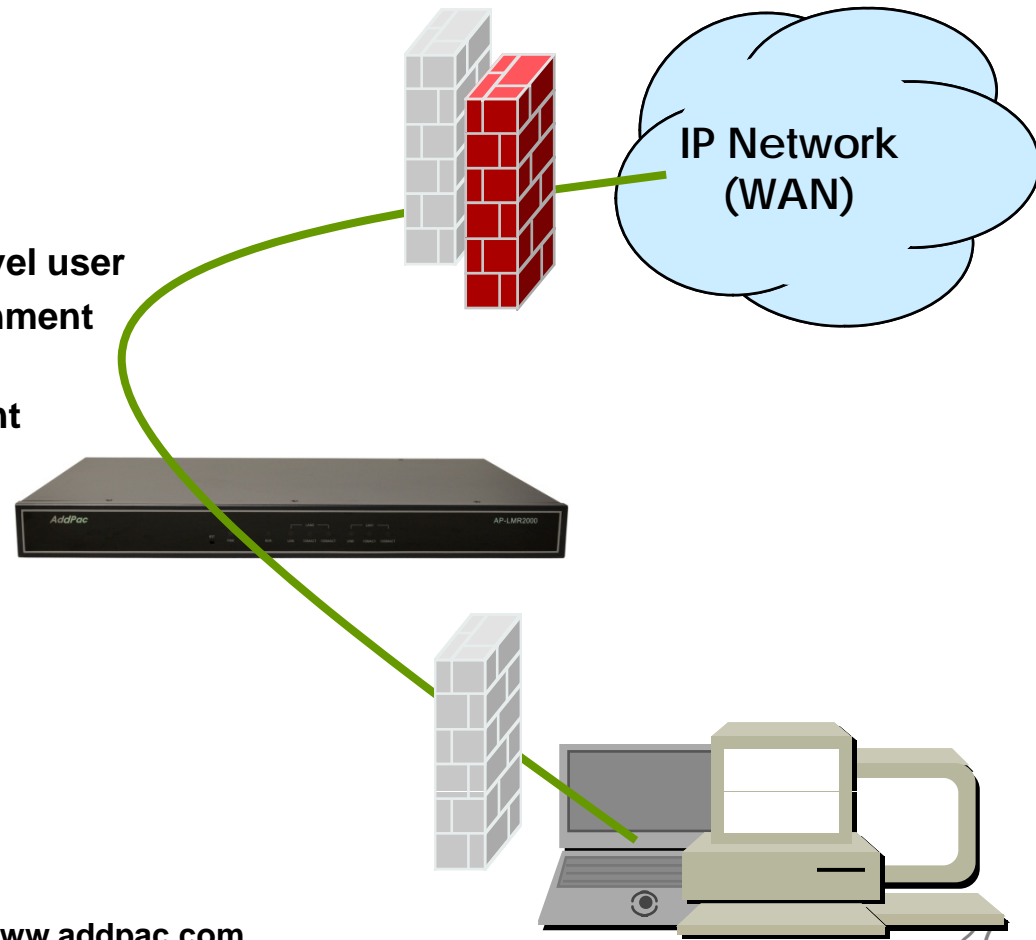

# Ordering Information

- **AP-LMR2000 LMR Gateway Hardware**
  - AP-LMR2000 Main Body
  - RISC Microprocessor with High-end Programmable DSP Architecture
  - Two(2) Module Slots for Radio Interface
  - 2-ports 10/100Mbps Fast Ethernet(RJ45)
  - Option Module: AP-RADIO2, etc
  - Including Network Cable & Ext. Power Supply, etc.
- **Built-in APOS Internetworking Software for AP-LMR2000**
- **Including 1 Year Hardware Warranty**
- **Product Documents**
  - Install and Operation Guide (PDF)
- **Pricing**
  - AddPac Technology Regional Sales Manager
  - Authorized Sales and Marketing Representatives
  - Please Contact [www.addpac.com](http://www.addpac.com)



# Thank you!

**AddPac Technology Co., Ltd.**  
Sales and Marketing

Phone +82.2.568.3848 (KOREA)

FAX +82.2.568.3847 (KOREA)

E-mail [sales@addpac.com](mailto:sales@addpac.com)