

# AV3000

## HD Video Codec Module

High-performance Network Surveillance Solution

HD/D1/CIF Triple Video Encoding  
Service Features for 3G Smart Phone

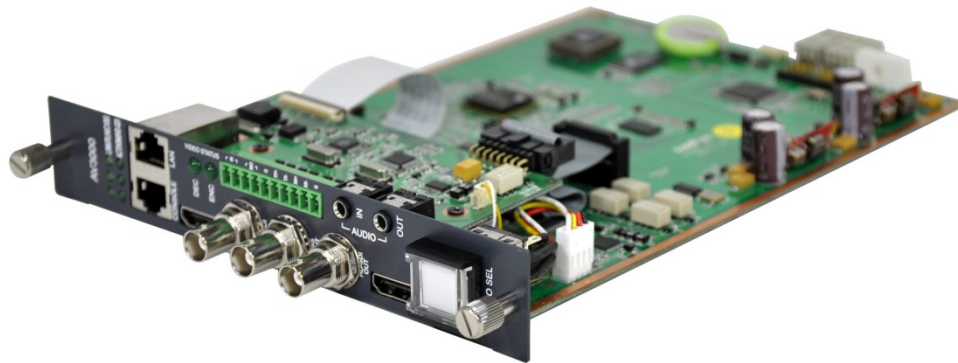

# **AddPac**

**AddPac Technology**

2011, Sales and Marketing

[www.addpac.com](http://www.addpac.com)



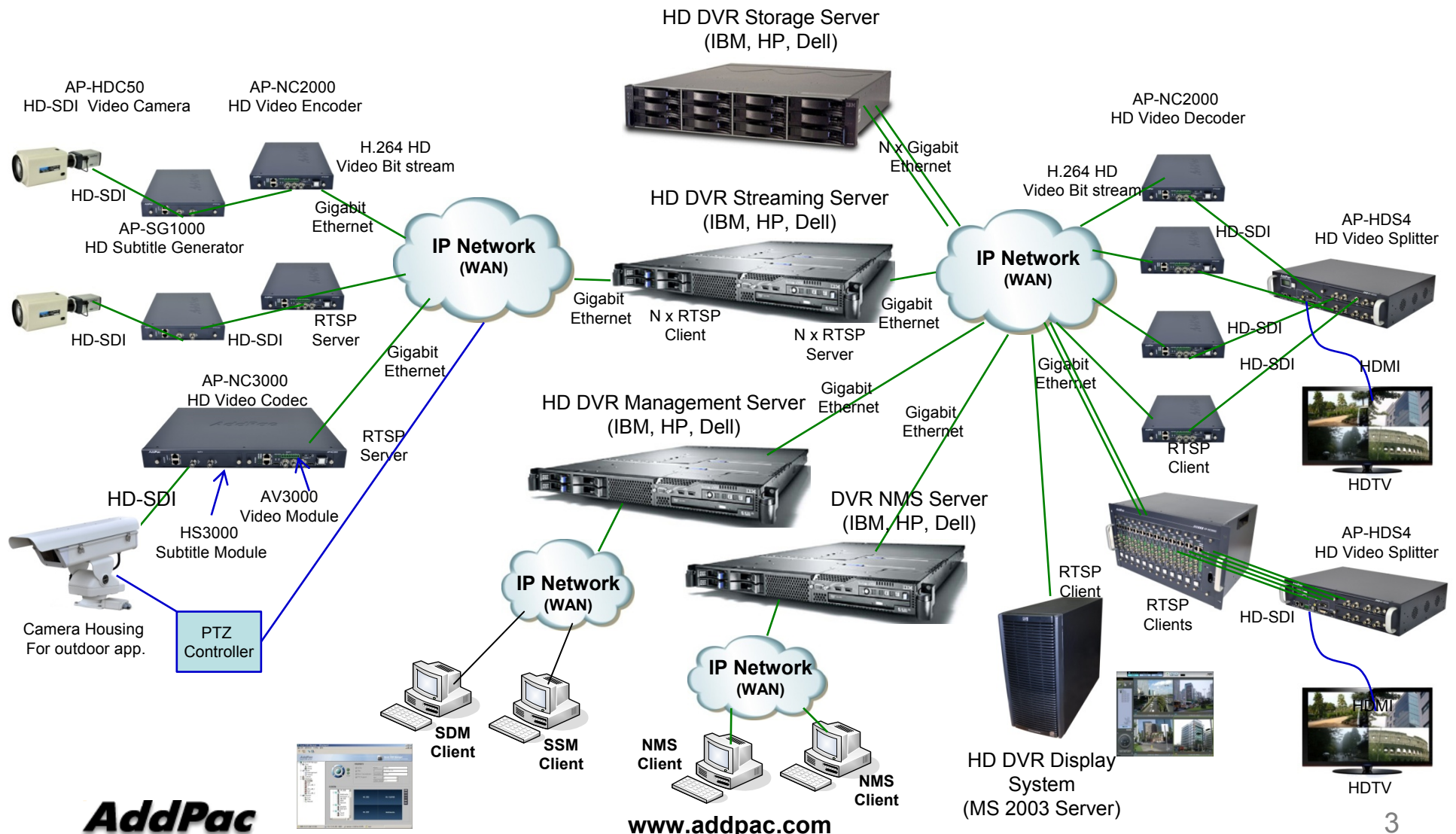

# Contents

- HD Network DVR Service Diagram
- AP-NC2000, AP-NC3000, AP-NC5000 Platform
- AV3000 Main Features
- AV3000 Hardware Specification
- AV3000 RSTP Service
- Video Codec Service Features

# HD Network DVR Service Diagram



# AP-NC2000, AP-NC3000, AP-NC5000 Platform

	AP-NC2000D	AP-NC2000	AP-NC3000	AP-NC5000
Model				
Module Slot	1 Module Slot	1 Module Slot	2 Module Slots	10 Module Slots
Power Supply	External Power Supply(DC)	Internal Power Module (AC)	Internal Power Module (AC)	Internal Power Module (AC)
Power Type	Power Adaptor	Built-In	Built-In	Module Type

# AV3000 HD Video Codec Modules

High-end  
**DSP**

## Main Features

- IP based HD Video Encoding/Decoding Solution
- H.264 Video Codec : Dual Encoding(720P, D1 Dual Encoding)
- RTSP, TCP/UDP Protocol Support
- RTP/RTCP Protocol Support
- One(1) Gigabit Ethernet Interface
- RS232/RS422/RS485 Interface for Camera Control
- Up to HD Video Resolution, Up to 30 frame/sec, Up to 8Mbps bandwidth
- IP based Network Surveillance Solution
- High-performance Video, Audio, and Voice Service
- Firmware Upgradeable Architecture
- Video Solution with Outstanding Network Service Capability

# AV3000 HD Video Codec Modules

High-end  
**DSP**

## Hardware Specification

- High-end Video Processor Architecture
- Network Interface
  - One(1) 10/100/1000Mbps Gigabit Ethernet (RJ45)
- Command Line Interface
  - One(1) RS-232C Interface (RJ45)
- Powerful Video Interface
  - Video Input : HD-SDI Input, HDMI Input, CVBS Video Input(BNC)
  - Video Output : HD-SDI Output, HDMI Output, CVBS Video Output(BNC)
- High quality Audio Interface
  - One(1) Audio Stereo Input, Output channel
- Camera Control Interface
  - One(1) RS-232C, RS422, RS485 Interface for External Camera Control
- I/O Interface
  - 2 Alarm Input, 1 Relay Out

# AV3000 HD Video Codec Modules

## Hardware Module Specification

AV3000 HD Video Encoder/Decoder Module(H.264)

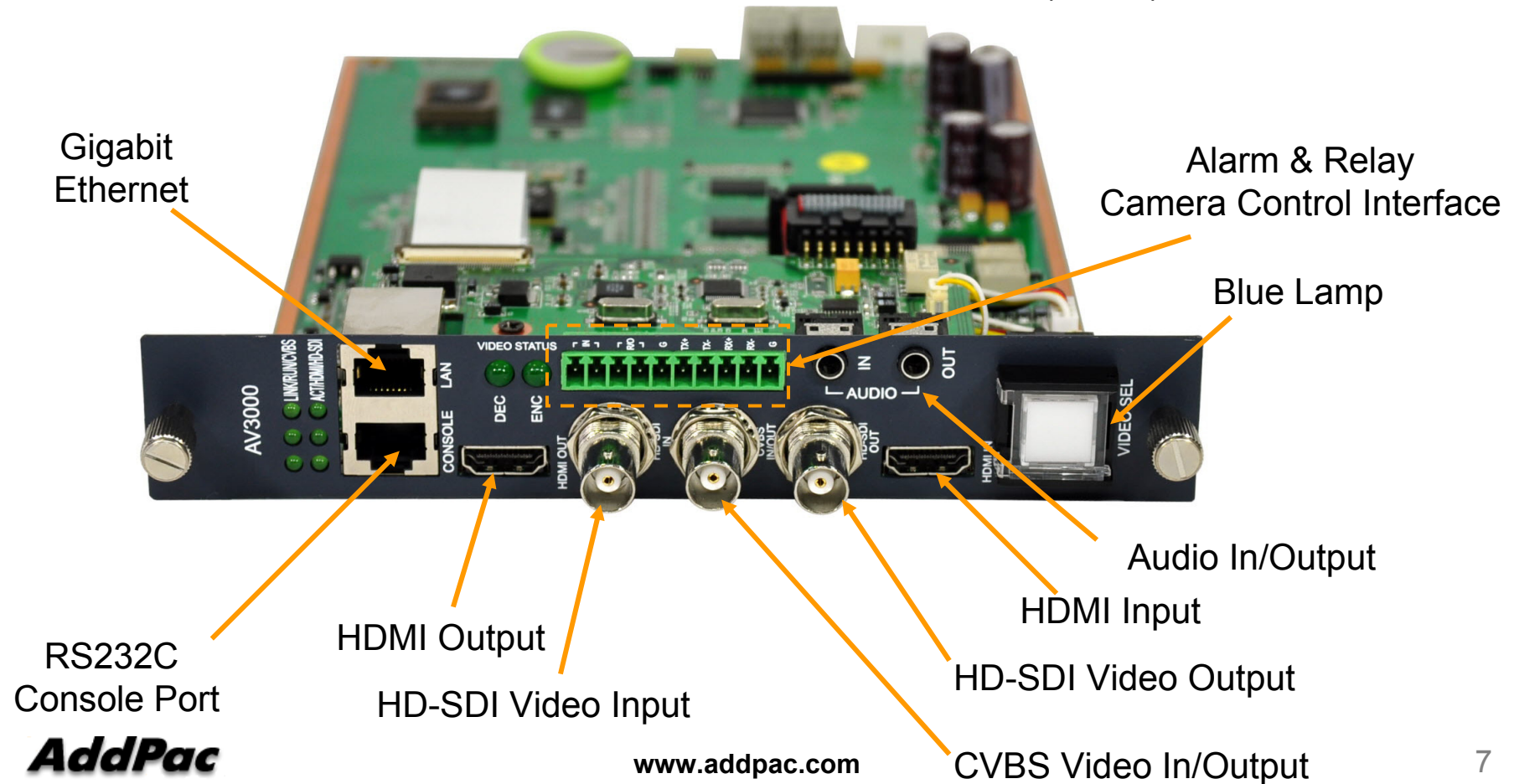

# AV3000 HD Video Codec Module

High-end  
**DSP**

## Triple Video Encoding Bit Stream Matrix

Video Input	Concurrent Video Encoding Bit Stream		
	CIF	D1	HD(720P)
Analog Video Input (NSTC/PAL)	Available	Available	N/A
HD-SDI Video Input (720P)	Available	Available	Available



# RTSP Service Network Diagram

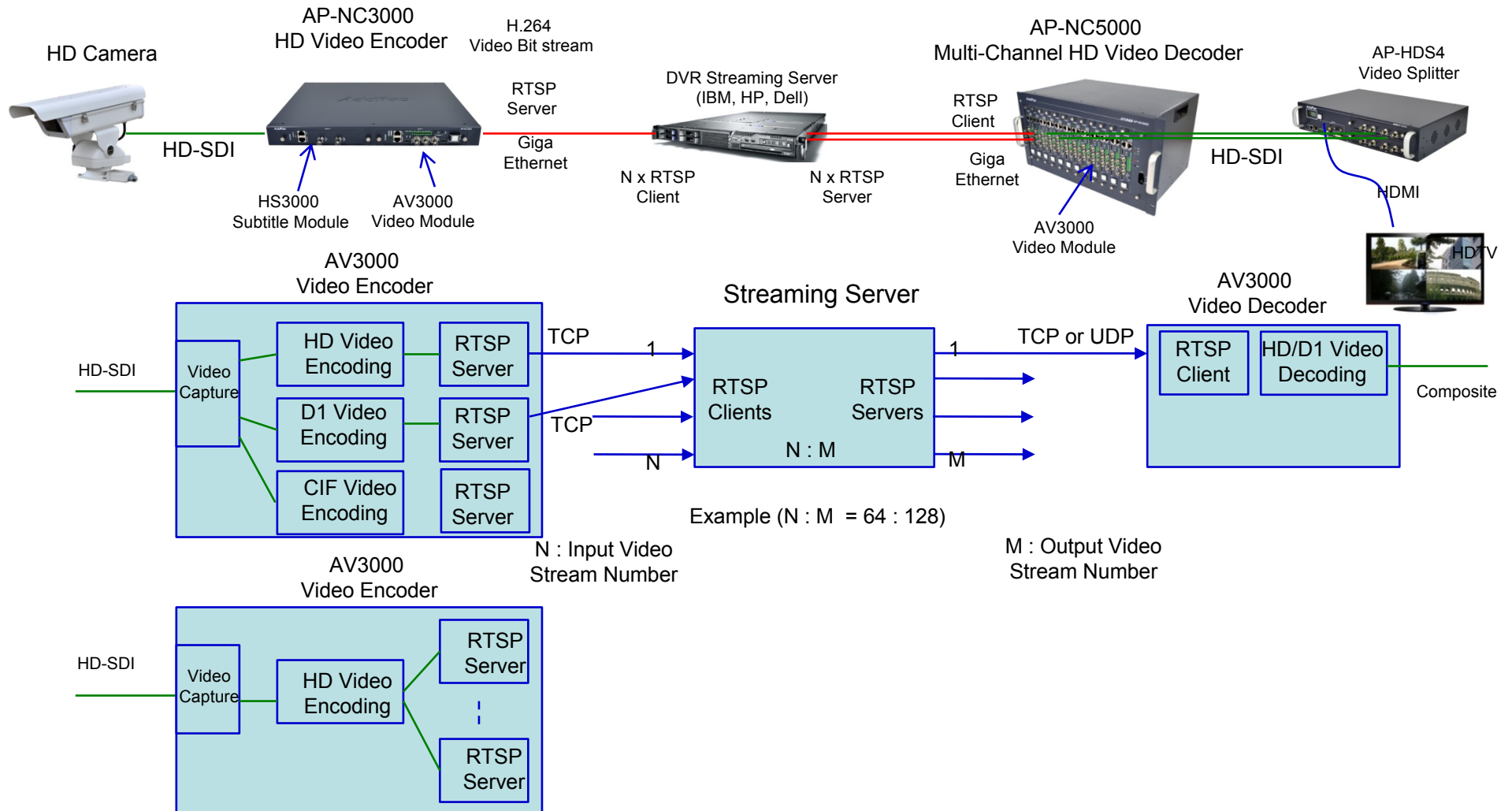

# RTSP Service Features

- Video Encoder Mode
  - RTSP Server Mode
  - Multi-Channel RTSP Server Mode  
(HD, D1, CIF Triple Video Encoding Mode, etc)
  - RTSP, TCP Protocol Support for Error Robust Service
- Video Decoder Mode
  - RTSP Client Mode
  - RTSP/TCP or RTSP/UDP Mode Support

# Video Codec Service Features

- AV3000 Video Encoder Mode
  - H.264 HD(720P) Single Encoding
  - H.264 D1(720x480) Single Encoding
  - H.264 CIF(352x288) Single Encoding
  - H.264 HD, D1 Dual Encoding
  - H.264 HD, D1, H.264 CIF Triple Encoding
- AV3000 Video Decoder Mode
  - H.264 HD
  - H.264 D1

# Video Codec Service Features

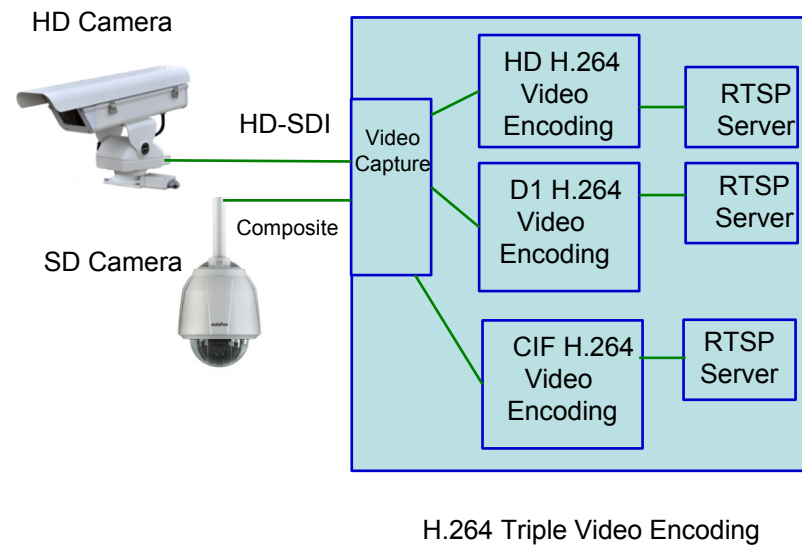
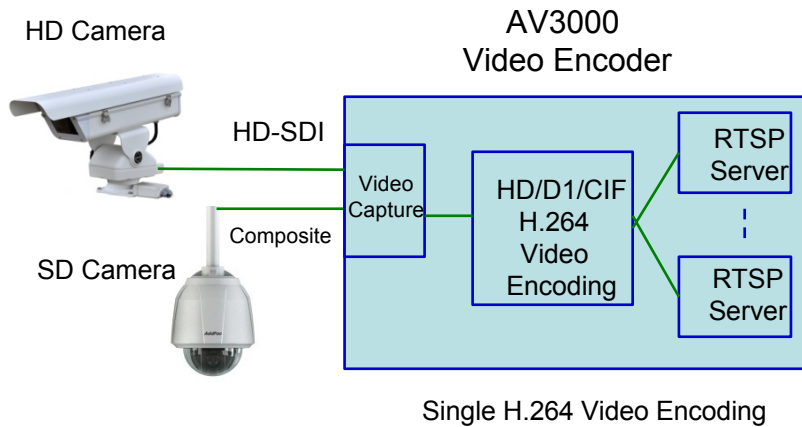

# Video Codec Service Features

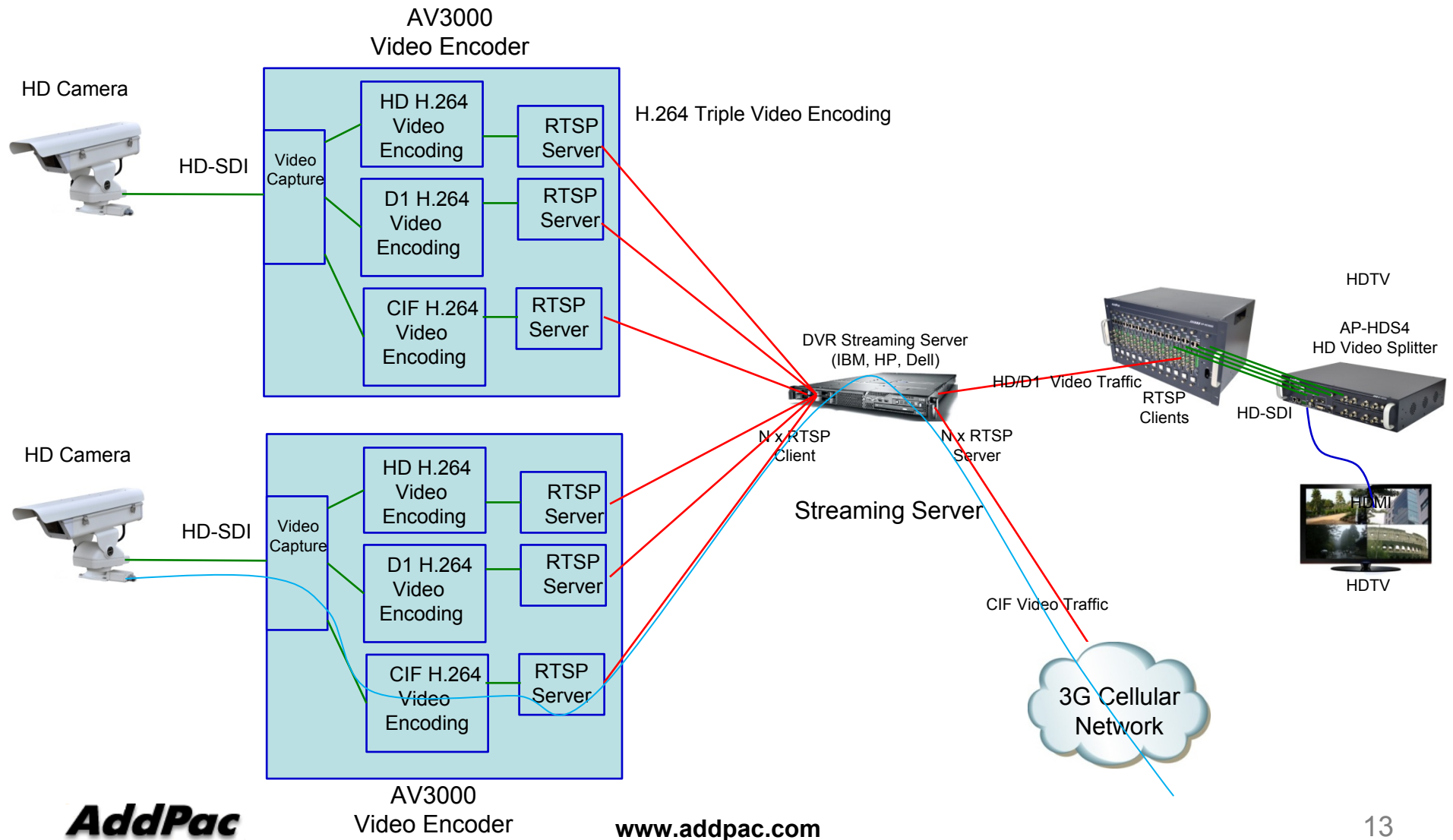



# Thank you!

**AddPac Technology Co., Ltd.**  
Sales and Marketing

Phone +82.2.568.3848 (KOREA)

FAX +82.2.568.3847 (KOREA)

E-mail [sales@addpac.com](mailto:sales@addpac.com)