



AP2650PMG

PTT Media Gateway

High Performance PTT Media Gateway Solution

Product Overview



AddPac

AddPac Technology

2011, Sales and Marketing

www.addpac.com

Contents

- Product Overview
- APOS Technology
- Hardware Specification
- PTT Service over Circuit Switch Network
- LMR Service Examples
- RoIP System Message Flow Diagram
- PTT Media Gateway Message Flow Diagram
- VoIP (Voice over IP) Service
- Advanced QoS Features
- Network Protocols
- Network Management
- Security Management
- Application Service
- Ordering Information

Product Overview

AP2650PMG PTT Media Gateway

- PTT over IP Service Support
- Radio Systems(Motorola, etc) are Extended to Circuit Switch Network(PSTN, Cellular) via IP Network
- High Performance RISC & Programmable DSP Architecture
- Two(2) 10/100Mbps Fast Ethernet (IP Share ,etc)
- High Performance LAN-to-LAN Routing Capability
- Four(4) Module Slots for PTT Media Gateway Service
- VoIP Codec : G.711/G.726/G.723/G.729, VAD, etc
- Powerful Network Protocols (PPPoE, DHCP, Static Routing, etc)
- IPv4/IPv6 Dual Stack Support
- SIP/H.323 Dual Concurrent Signaling Protocols
- Firmware Upgradeable Architecture
- Advanced Voice QoS Mechanism
- Powerful Web based Management
- RS232C Port Support for Command Line Interface
- Dual Power Supply for Redundancy

Product Highlights

AP2650PMG PTT Media Gateway

PTT Media Gateway Solution for Circuit Switch Network (PSTN, Cellular)

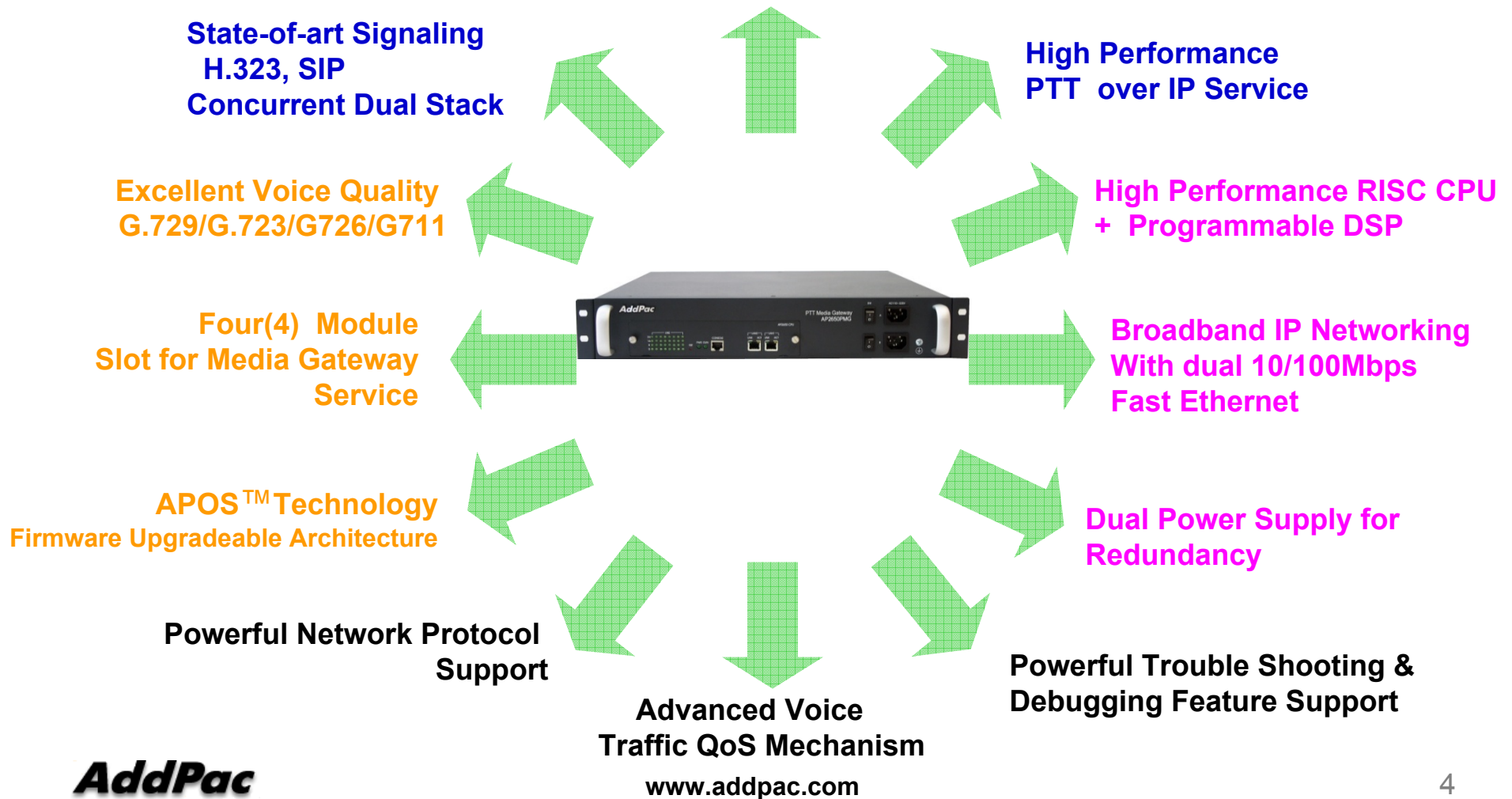

APOS Technology

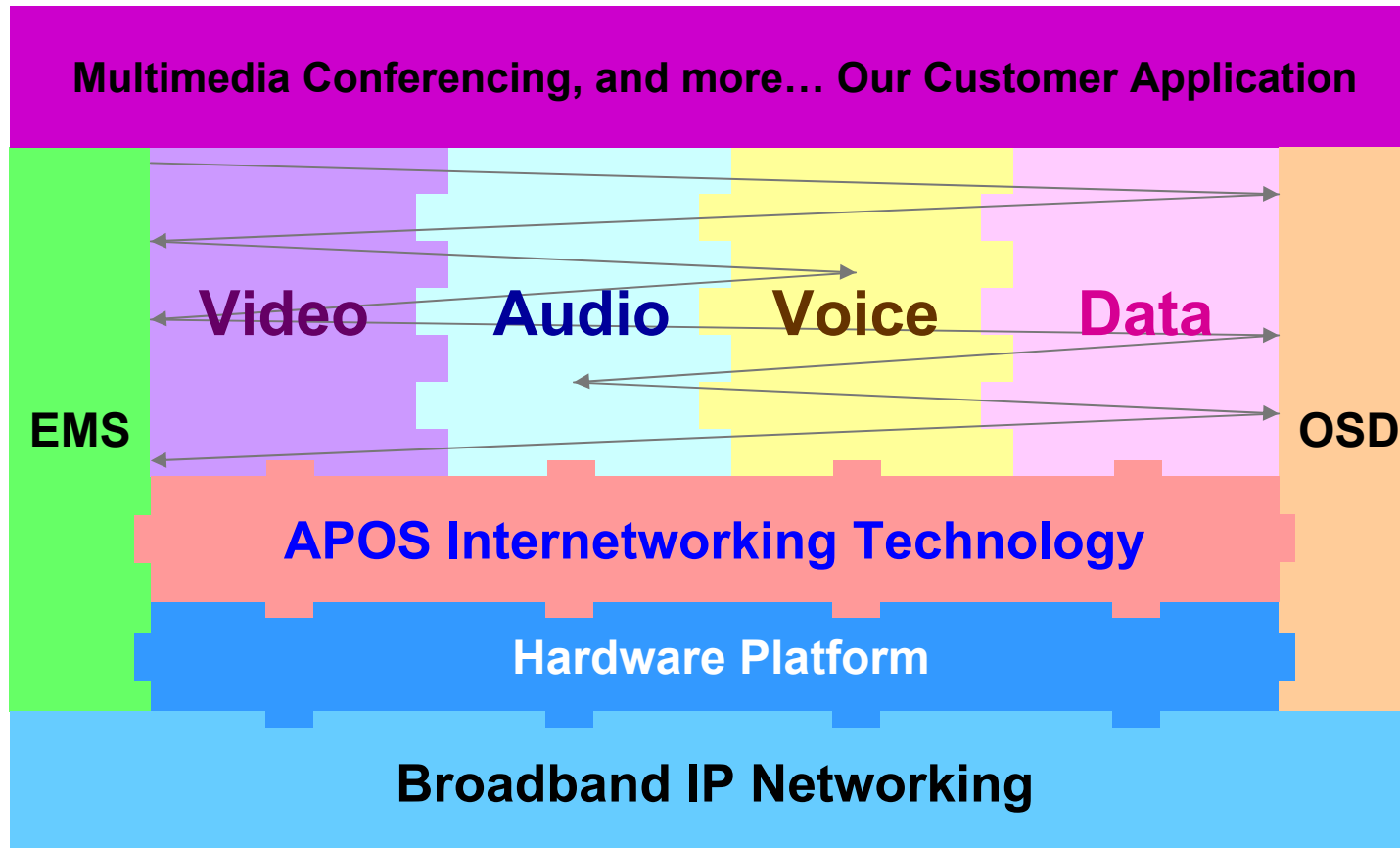

- APOS : AddPac Internetworking Operating System
- OSD : On- Screen Display
- EMS : Element Management System

Hardware Specification

AP2650PMG PTT Media Gateway

RISC
CPU

High-end
DSP

- RISC Microprocessor Computing Power
- Main Chassis
 - Module Type System Processor Interface
 - Two(2) 10/100Mbps Fast Ethernet
 - One(1) RS-232C Console (RJ45)
 - Four(4) Module Slots for FXS, FXO, Digital E1/T1, etc
 - Dual Power Supply



RS232C
Console Port

LAN0(10/100Mbps)

LAN1 (10/100Mbps)

Power Switch

Power Inlet

AddPac

www.addpac.com

Hardware Specification





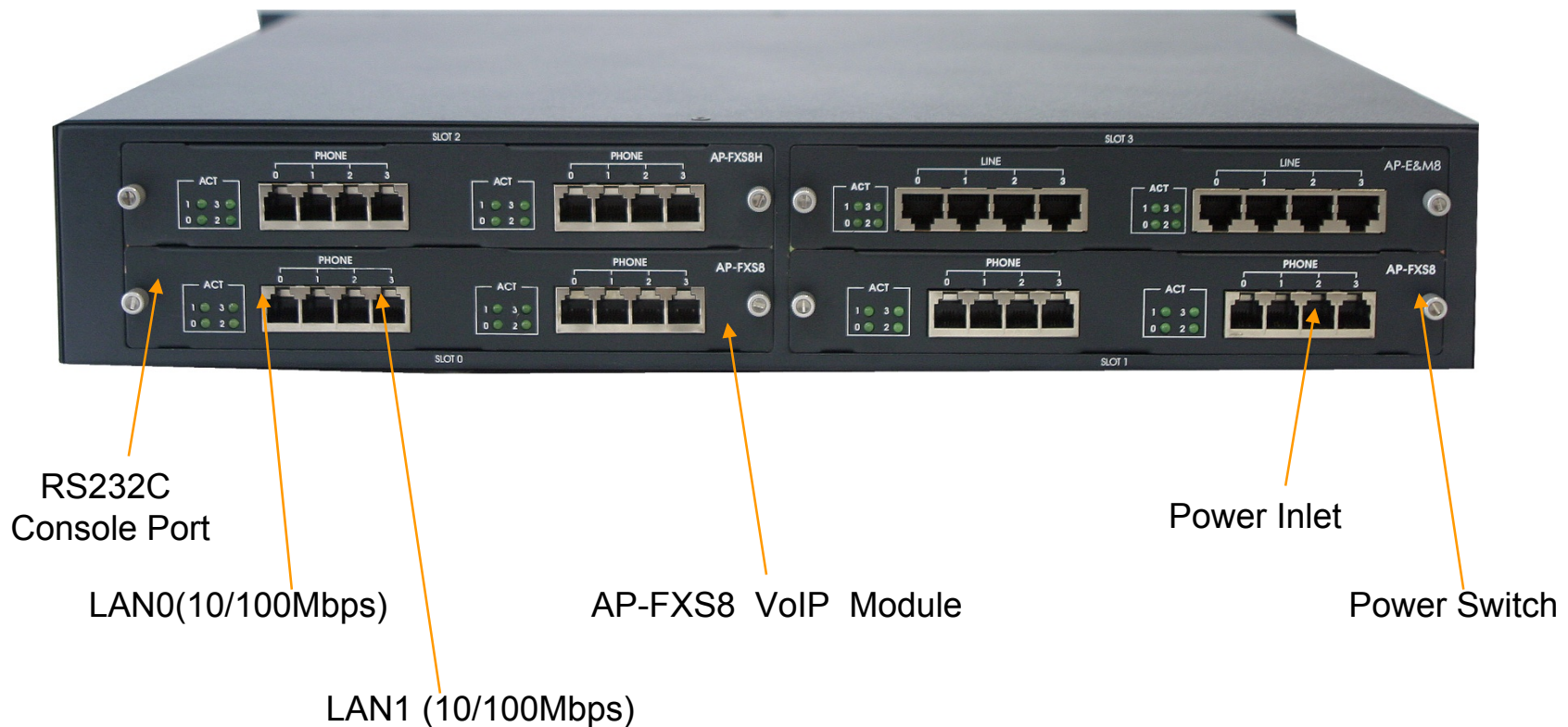

AP2650PMG PTT Media Gateway

AP2650PMG Back Side



Hardware Specification

AP2650PMG PTT Media Gateway

| Target | VoIP Modules | Module Features | Module Picture |
|-----------------------------|--------------------|------------------------------|---|
| AP2120N AP2640 AP2650 | AP-FXS8 | 8-Port FXS Module |  |
| AP2120N AP2640 AP2650 | AP-FXO8 | 8-Port FXS Module |  |
| AP2120N AP2640 AP2650 | AP-FXS4O4 | 4-Port FXS&4-Port FXO Module |  |
| AP2120N AP2640 AP2650 | AP-E&M8 | 8-Port E&M Module |  |
| AP2640 AP2650 | AP-E1 | 1-Port Digital E1/T1 Module |  |
| AP2640 AP2650 | AP-2E1 | 2-Port Digital E1/T1 Module |  |

PTT Service over Circuit Switch Network

AP2650PMG PTT Media Gateway

- **AddPac PTT Service Solution Features**
 - PTT Media Gateway(AP2650PMG) joins the PSTN analog phones, Cellular Phones to the IP network through open SIP standard and RTP.
 - Analog phones, Cellular phones are connected to PTT media gateway through Circuit Switch Network such as PSTN, Cellular Network, etc.
 - AddPac IP PTT terminals (AP-IP230, AP-IP300 IP Phones, AP-WP100 WiFi-Phone, etc) support the traditional analog phone user interface(PTT).
 - AddPac IP PTT terminals easy PTT group management user interface.
 - IP-PBX support call management, PTT group management, PTT control and various additional service.
 - PTT Server(AP-PTS3000) support powerful media data relay, broadcasting, multicasting and PTT group management..

LMR Service Examples

AP2650PMG PTT Media Gateway

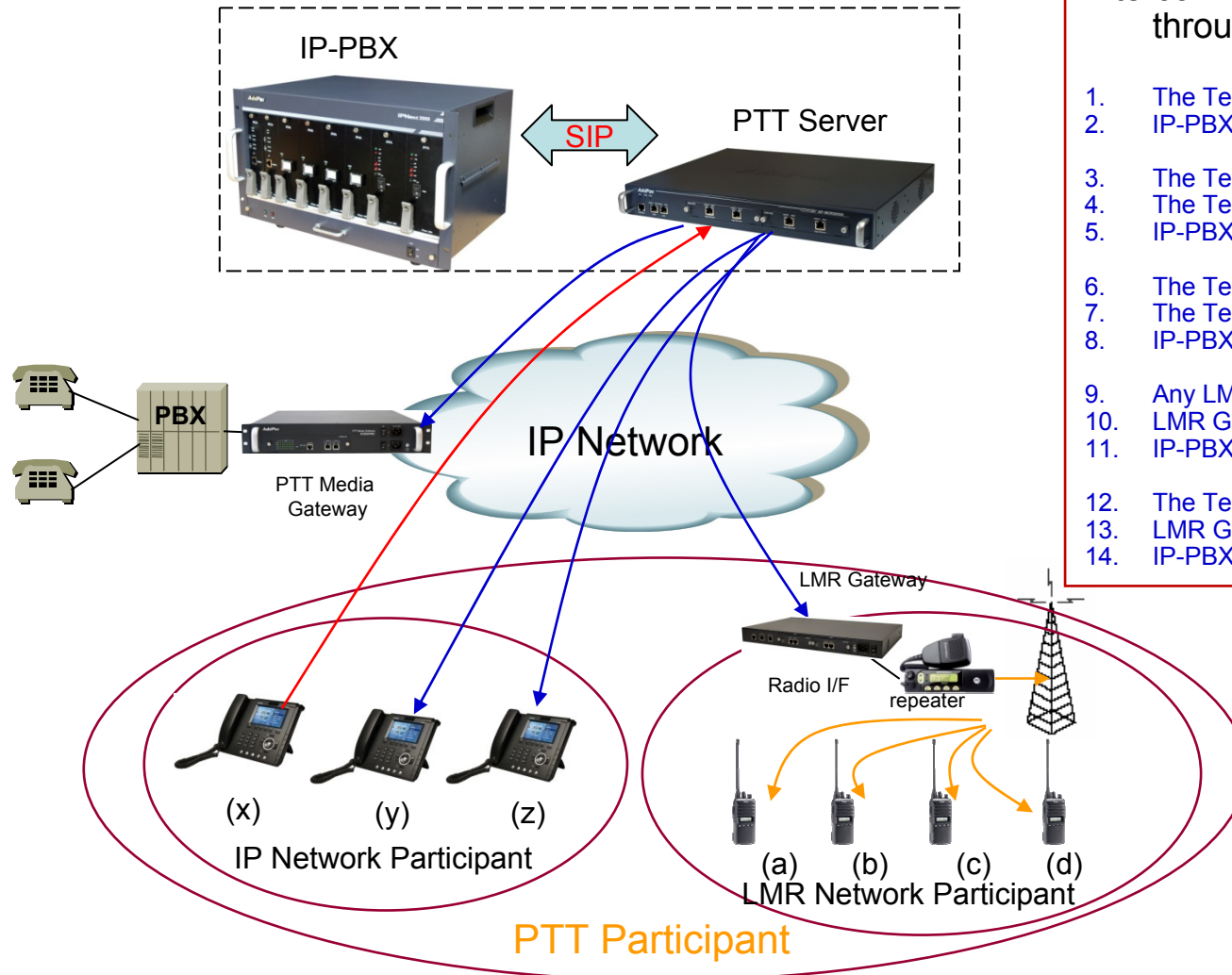

Interconnection LMR systems to IP network through AddPac RoIP solution.

1. The Terminal(x) originate a PTT conference.
2. IP-PBX send invitation message to all participant.
3. The Terminal(x) presses the 'floor button' to talk.
4. The Terminal(x) send a 'floor-request' message.
5. IP-PBX and PTT servers control media-relay.
6. The Terminal(x) releases the 'floor button'.
7. The Terminal(x) send a 'release-request' message.
8. IP-PBX and PTT servers control media-relay.
9. Any LMR Terminal(a~d) presses the 'floor button' to talk.
10. LMR Gateway send a 'floor-request' message.
11. IP-PBX and PTT servers control media-relay.
12. The Terminal(a) releases the 'floor button'.
13. LMR Gateway send a 'release-request' message.
14. IP-PBX and PTT servers control media-relay.

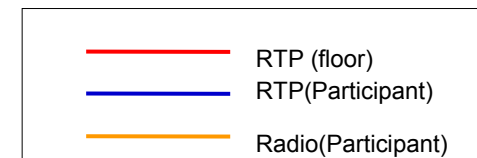

RoIP System Message Flow

AP2650PMG PTT Media Gateway

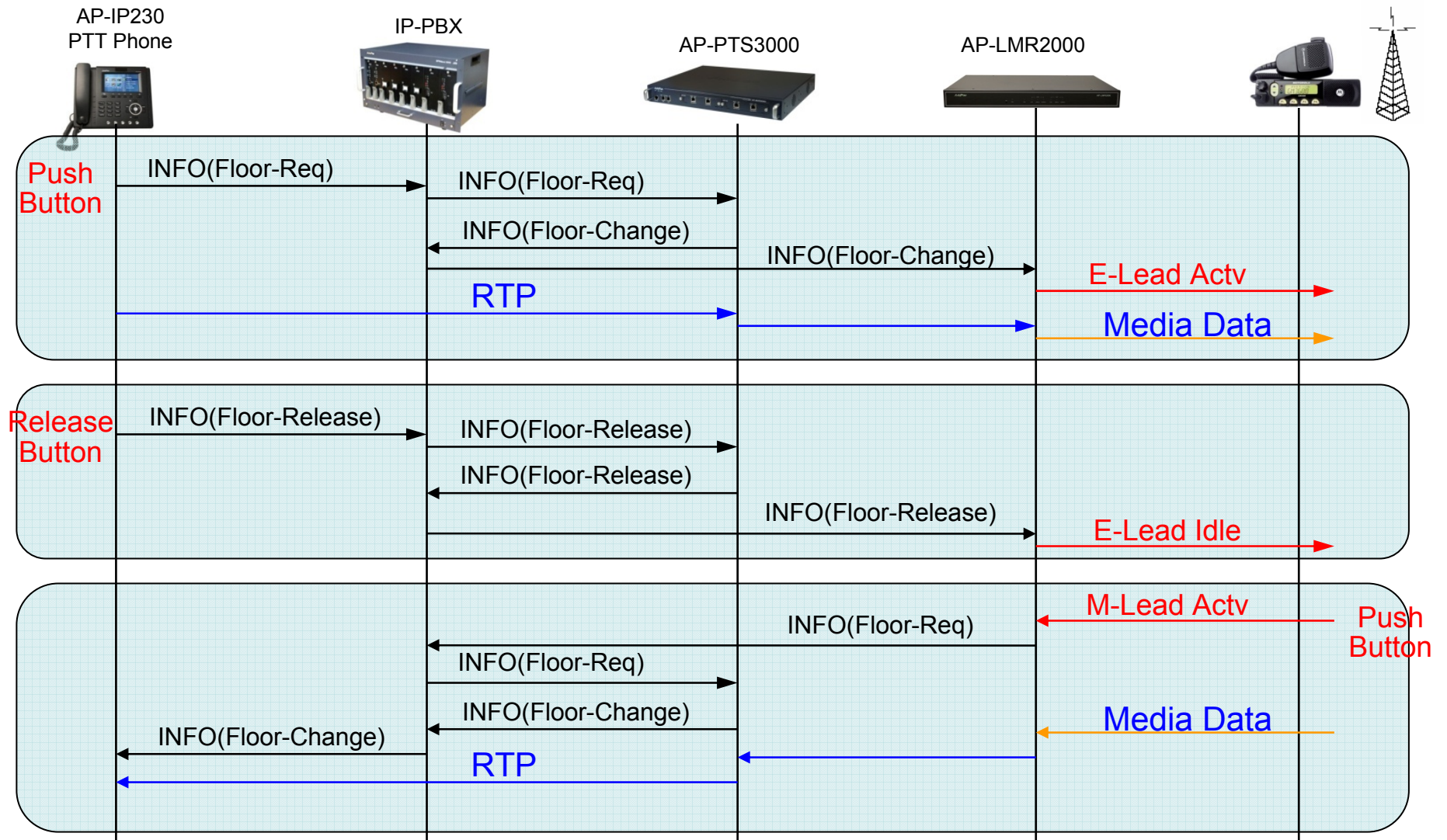

PMG System Message Flow

AP2650PMG PTT Media Gateway

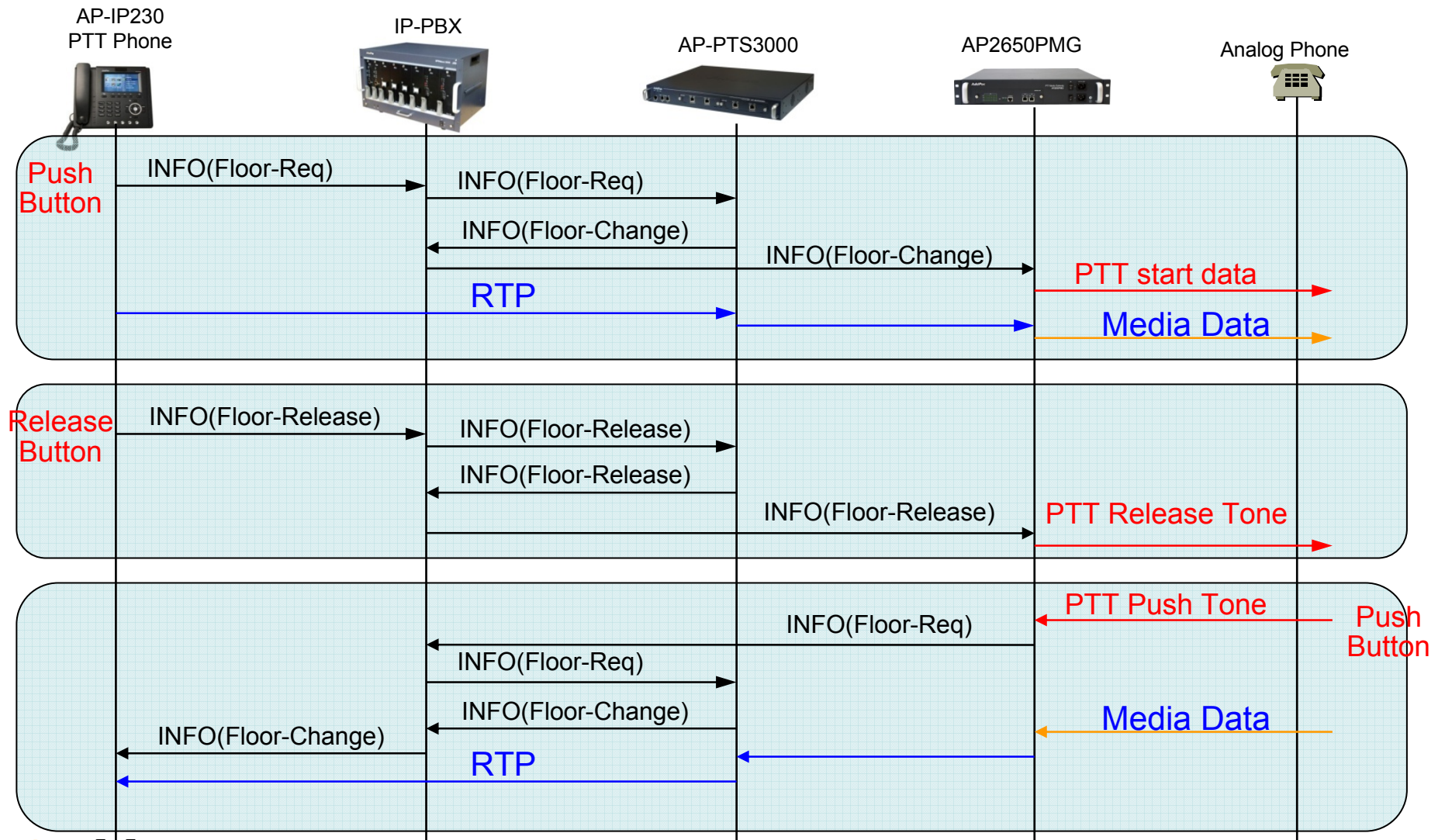

VoIP (Voice over IP) Service

AP2650PMG PTT Media Gateway

- **H.323, SIP Dual Stack**
- **H.323**
 - ITU-T Standard H.323 v3 Support
 - Support H.245 Tunneling
 - Including H.235 Security Features
- **SIP**
 - IETF RFC3261 or RFC2543 SIP Standard

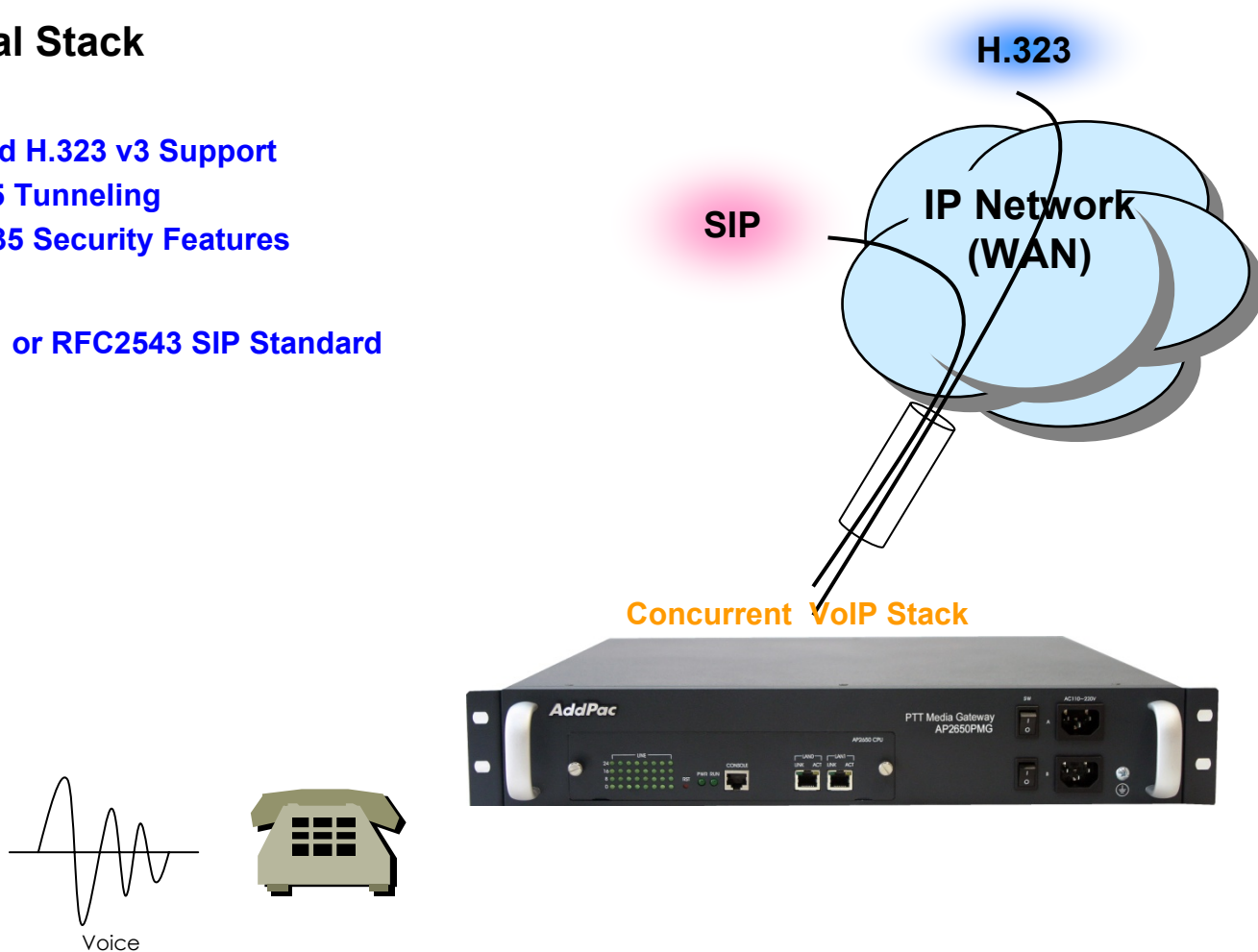

VoIP (Voice over IP) Service

AP2650PMG PTT Media Gateway

- **H.323**

- Fast connect, normal connect support
- H.245 tunneling support
- Q.931 response message setting for inbound VoIP calls
- H.245 logical channel open timing selection function
- Start H.245 procedure support
- DTMF / Hook flash relay with H.245 alphanumeric / signal
- Secondary gatekeeper support
- Gatekeeper assignment according to the domain name
- Gatekeeper discovery with multicast
- Lightweight RRQ support
- Signaling TCP port assignment
- Resource threshold setting with RAI
- H.235 clear-token, crypto-token support
- canMapAlias support
- Technical prefix (supported prefix) support
- Public IP assignment in NAT environment

- **SIP**

- Gateway-based / Endpoint-based registration support
- Secondary proxy-server assignment function
- SIP signaling port change function
- SIP proxy server assignment according to the domain name
- T.38 real-time fax relay support
- DTMF relay support with RFC2833 / OPTION message
- Re-INVITE support

VoIP (Voice over IP) Service

AP2650PMG PTT Media Gateway

- **Voice Codec**

- G.711 A-Law, G.711 U-Law
- G.726 r16, G.726 r32
- G.729A
- G.723.1 r63, G.723.1 r53
- VAD (Voice Activity Detection) function support
- DTMF relay support (H.323, SIP, MGCP common) based on RFC2833

- **RTP**

- Redundant RTP packet transmission in case of severe packet loss
- Dynamic jitter buffer management and RPT packet jitter and loss compensation with heuristic & DSP error concealment
- Static jitter buffer setting support
- Voice frame per RTP packet number control for each codec
- In-band ring-back tone support
- Virtual ring-back tone support
- Tone parameter change support



VoIP (Voice over IP) Service

AP2650PMG PTT Media Gateway

• VoIP Call Controls

- Hot line connection function with PLAR (Private Line Auto Ring Down)
- Leased line emulation function
- Connection monitoring function
- Fault tolerant with Redundancy and Call Distribution among Gateways for load balancing
- Call attempt with IP address
- H.323, SIP, MGCP inbound call connection for each voice port
- Multiple E.164 setting for one voice port
- One E.164 or digit pattern can be assigned to more than one voice port
- Hunting with Longest match/ priority/ sequence/ random
- One stage call setup by Digit forwarding
- Call barring with specific digit patterns
- Calling and called number conversion for PSTN outbound calls
- PSTN rerouting in case of VoIP call attempt failure

• VoIP Call Controls (cont.)

- Call transfer for internal calls
- Call pickup for internal calls
- Calling and called number conversion for VoIP outbound calls
- Calling and called number conversion for VoIP inbound calls
- Fax broadcasting call control

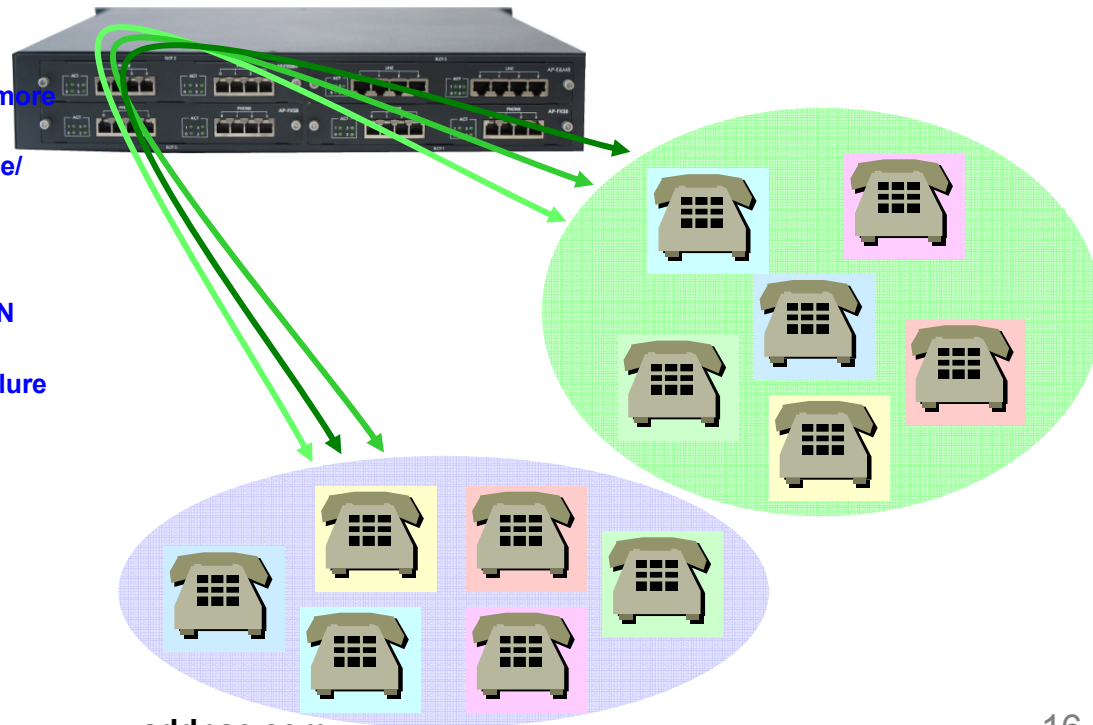

Advanced QoS Features

AP2650PMG PTT Media Gateway

- Enhances **Transmit** Voice QoS Features
 - Voice Traffic Priority Queuing
 - QoS Service Profiling
 - Providing Virtual Network Transmit Algorithm
 - Real-time Voice Traffic QoS Support
 - RTP Packet Transmit Interval Control
 - Supporting RTP Packet Redundancy Scheme
 - IP Header Control such as ToS, Diffserv
- Enhances **Receive** Voice QoS Features
 - Dynamic Jitter Buffer Management
 - Error Concealment
 - Support T.38 FAX Data Error Recovery Scheme

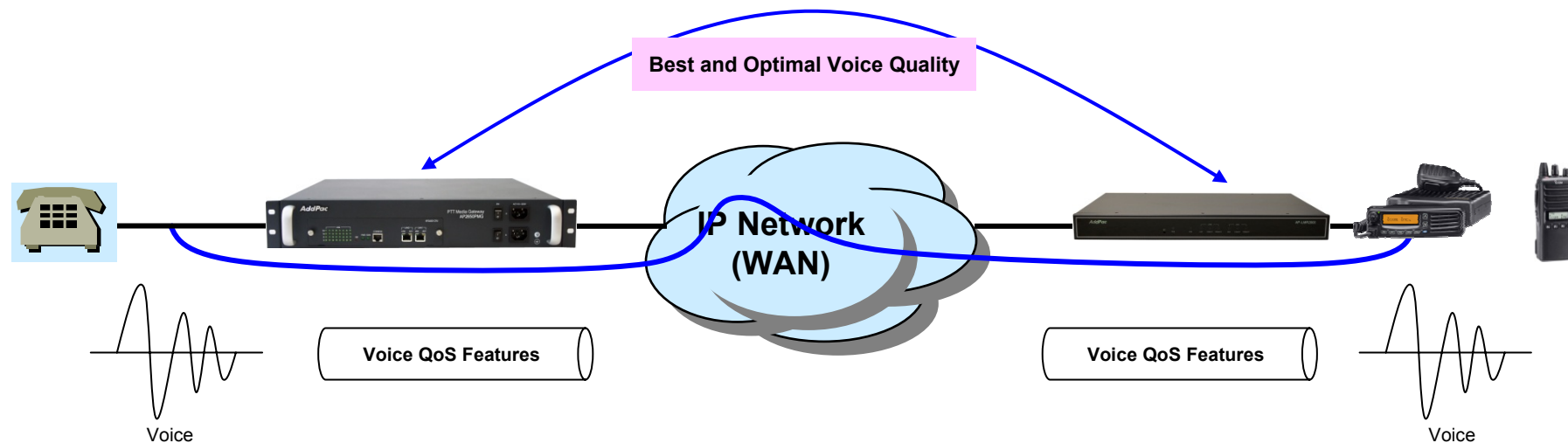

Network Protocols

AP2650PMG PTT Media Gateway

Basic Network Protocols

- ARP, IPv4, TCP, UDP, ICMP, SCTP, IGMP, MLD

Routing Protocol

- IPv4 : Static

Service Protocol

- FTP, Telnet, TFTP, DHCP Server/Relay, SNMP Server
- CDP (Cisco Discovery Protocol)
- DNS Resolver , DDNS(nsupdate)
- Bridge
- Syslog

IPv4 Address Configuration

- Fixed (Static)
- DHCP
- PPPoE

Miscellaneous

- Cisco Style CLI
- Standard & Extended IPv4 Access List
- Multi-level User Account Management
- IP accounting
- STUN Client

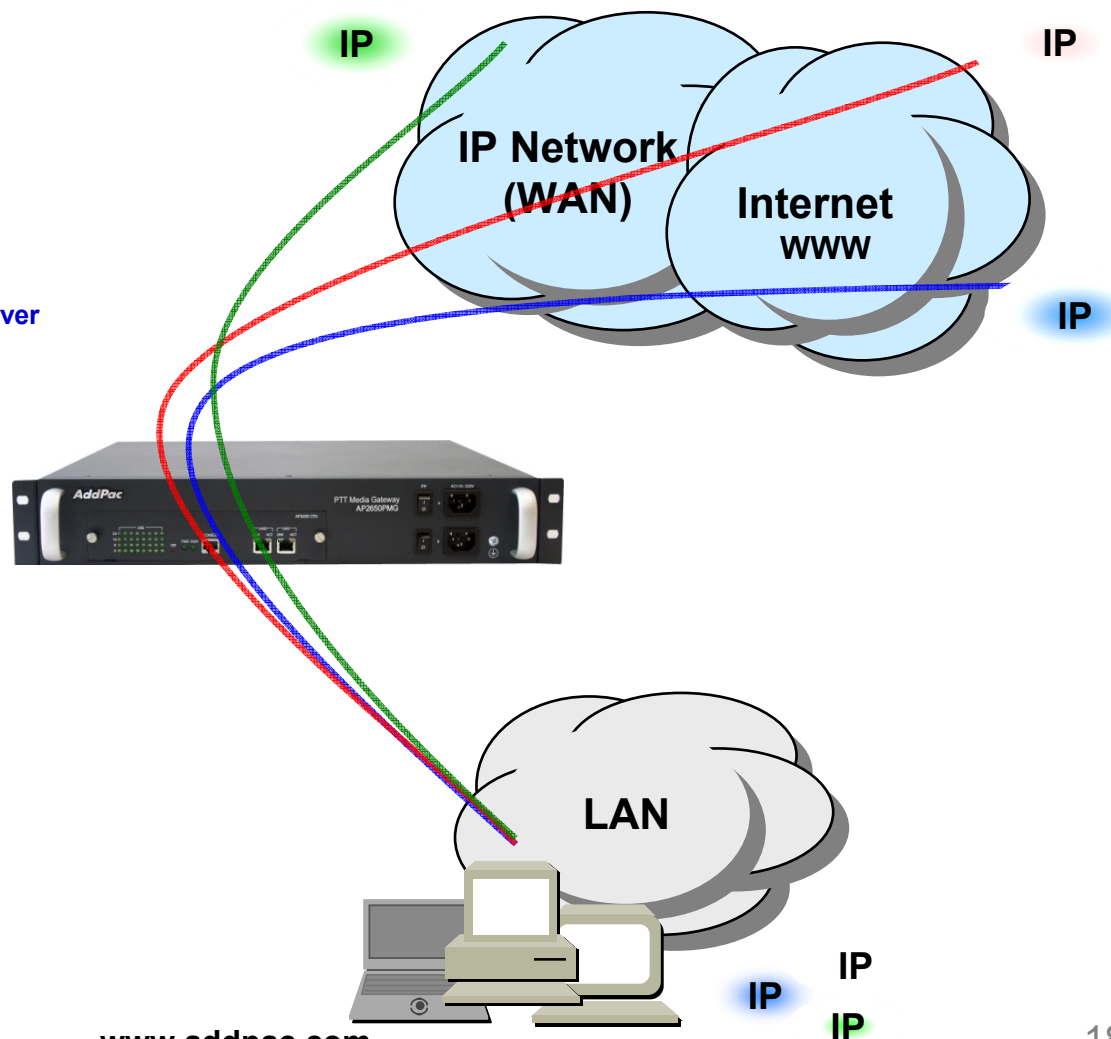

Network Management

AP2650PMG PTT Media Gateway

- **SNMP**
 - Standard Simple Network Management Protocol(SNMP) Agent support
 - MIB v1 and v2 Support
- **Web-based Management**
 - Smart Easy Setup
 - Standard Voice Interface
 - Standard PSTN Back-up Interface
- **Watch-dog Function**
 - Hardware, Software watch-dog services
- **Remote Management**
 - Telnet
 - Rlogin
- **Auto Upgrade Service**
 - HTTP server based APOS image and configuration file auto-upgrade support
- **Batch Job Function**
 - Text based script downloading
- **Interoperable with AP-VPMS Service**
 - AddPac VoIP Plug & Play Management System (AP-VPMS)

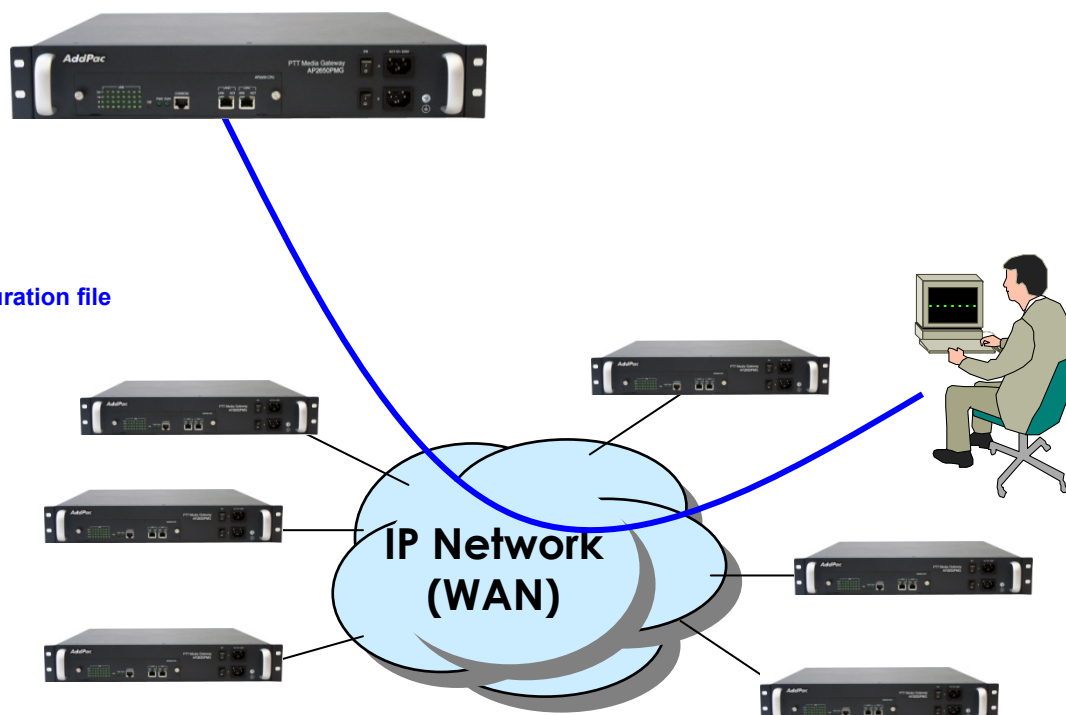

Security Management

AP2650PMG PTT Media Gateway

- IP packet filtering
- IP access list
- User authentication function
 - Password Authentication Protocol (PAP)
 - Challenge Handshake Authentication Protocol (CHAP)
- Enable/Disable specific protocols
- Auto-square connect of Telnet session
- Account Management function for multi-level user
- SNMP/TELNET/FTP/HTTP/TFTP port assignment function
- SNMP/TELNET/FTP access list management
- Boot mode security checking function

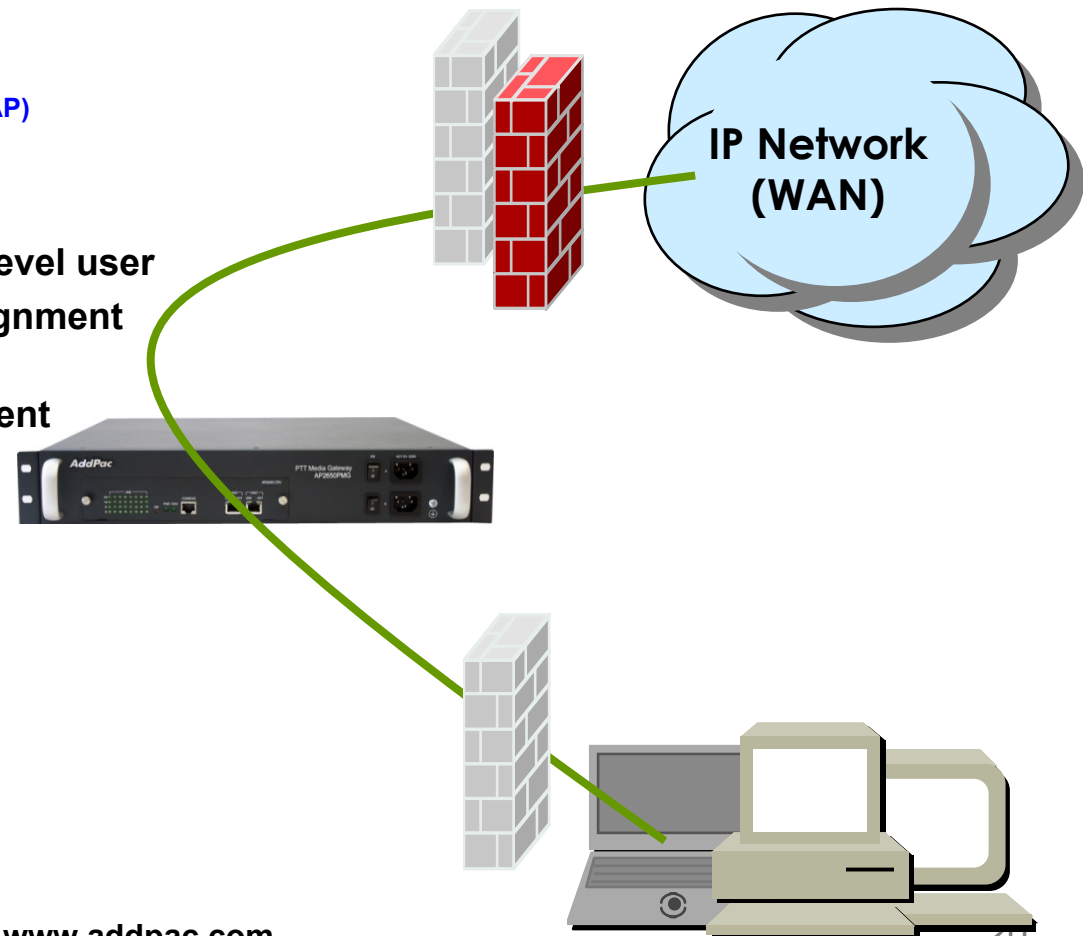

Standard Application

AP-LMR2000 LMR Gateway

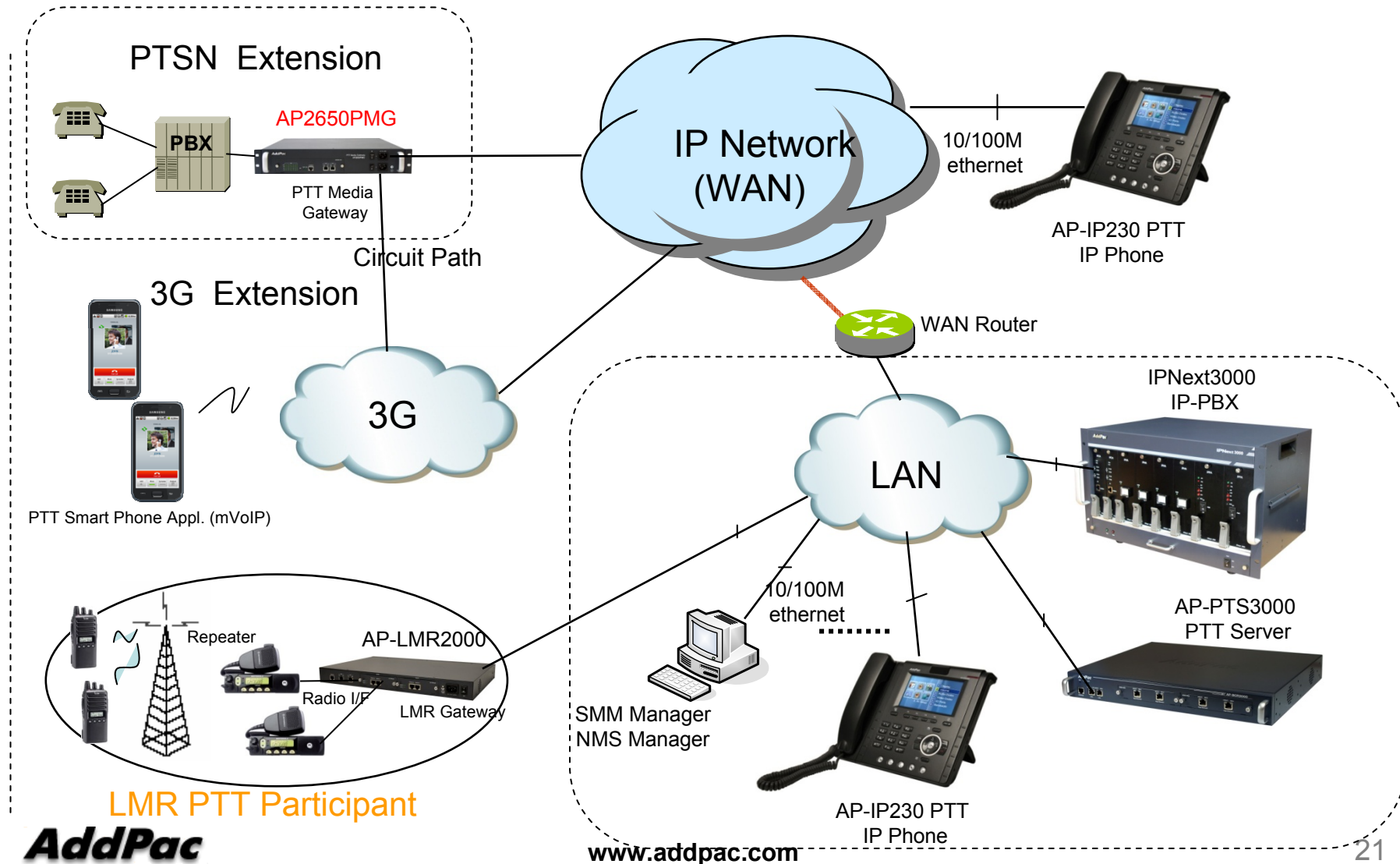

Ordering Information

- **AP2650PMG PTT Media Gateway Hardware**
 - AP2650 Main Body
 - RISC Microprocessor with High-end Programmable DSP Architecture
 - Four(4) Module Slots for Media Interface
 - 2-ports 10/100Mbps Fast Ethernet(RJ45)
 - Option Module: AP-FXS8, AP-FXO8, AP-E1/T1, etc
 - Including Network Cable & Ext. Power Supply, etc.
- **Built-in APOS Internetworking Software for AP2650PMG**
- **Including 1 Year Hardware Warranty**
- **Product Documents**
 - Install and Operation Guide (PDF)
- **Pricing**
 - AddPac Technology Regional Sales Manager
 - Authorized Sales and Marketing Representatives
 - Please Contact www.addpac.com



Thank you!

AddPac Technology Co., Ltd.
Sales and Marketing

Phone +82.2.568.3848 (KOREA)

FAX +82.2.568.3847 (KOREA)

E-mail sales@addpac.com