



AP-MC1800™

Video MCU

High-performance Video MCU Solution

H.323 Conference Features



AddPac

AddPac Technology

2011, Sales and Marketing

www.addpac.com

H.323 Conference Feature

- H.243 Support for Conference Control
- H.224 Relay for Remote Camera Control
- H.239 Support for Presentation
- Compatibility



H.243 Support for Conference Control

- **General**
 - Participants: show participants in conference
 - Chair Request
 - Floor Request, Floor Release
- **Chair control**
 - Give Floor, Take Floor
 - Remove terminal
 - Chair Release

Conference Init



Show Participants

Request Floor

Request Chair

Next Menus

Participants (of general participant)



Exit Participants

Participants (of chair)



Drop the Selected Terminal

Give Floor to the Selected Terminal

Exit Participants

Floor given by chair



Take Floor from the Selected Terminal

When floor, can release the floor

Remote View 10/19 Fri 10:28

Floor Mark

Participants Rel. Floor Req. Chair >>

Release floor

When chair, can release the chair



Release Chair

Next Menus (of general participants)



H.239 Presentation

Call Status Information

Return to Initial Menus

Next Menus (of Chair)



Quit This Conference

H.224 Relay for Remote Camera Control

- **H.224 Relay**
 - H.281(FECC) message relay on H.224 channel
 - Each terminal which supports FECC can control cameras of other terminals which also support FECC via AP-MC3000 H.224 relay channel
- **FECC functions**
 - Terminal selection to control
 - Pan
 - Tilt
 - Zoom
 - Focus
 - Camera selection to control
 - Preset

Remote Terminal Selection

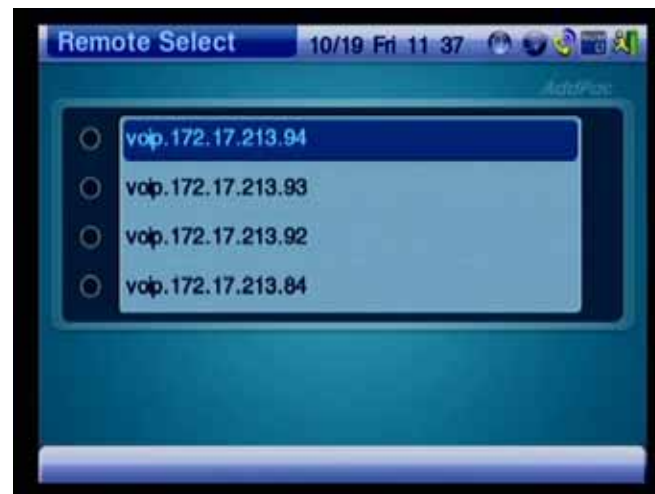
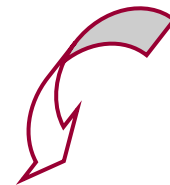

Camera Selection



Camera Select



Main

Auxiliary

Document

VCR

Document Auxiliary

Pan, Tilt, Zoom



PTZ

Use remote controller to control

PTZ status mark



Set Preset



Set Preset



AddPac

Edit Preset Name

www.addpac.com



Result

Display Preset



Display Preset

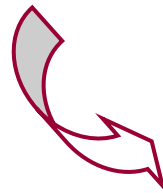

H.239 Support for Presentation

- **Presentation via Dual Video Channel**
 - Each terminal which supports H.239 can make a second video channel with AP-MC3000 Video MCU
 - Each participant can see main primary video and presentation video at the same time
 - Right now, H.263 supported only

Presentation Init

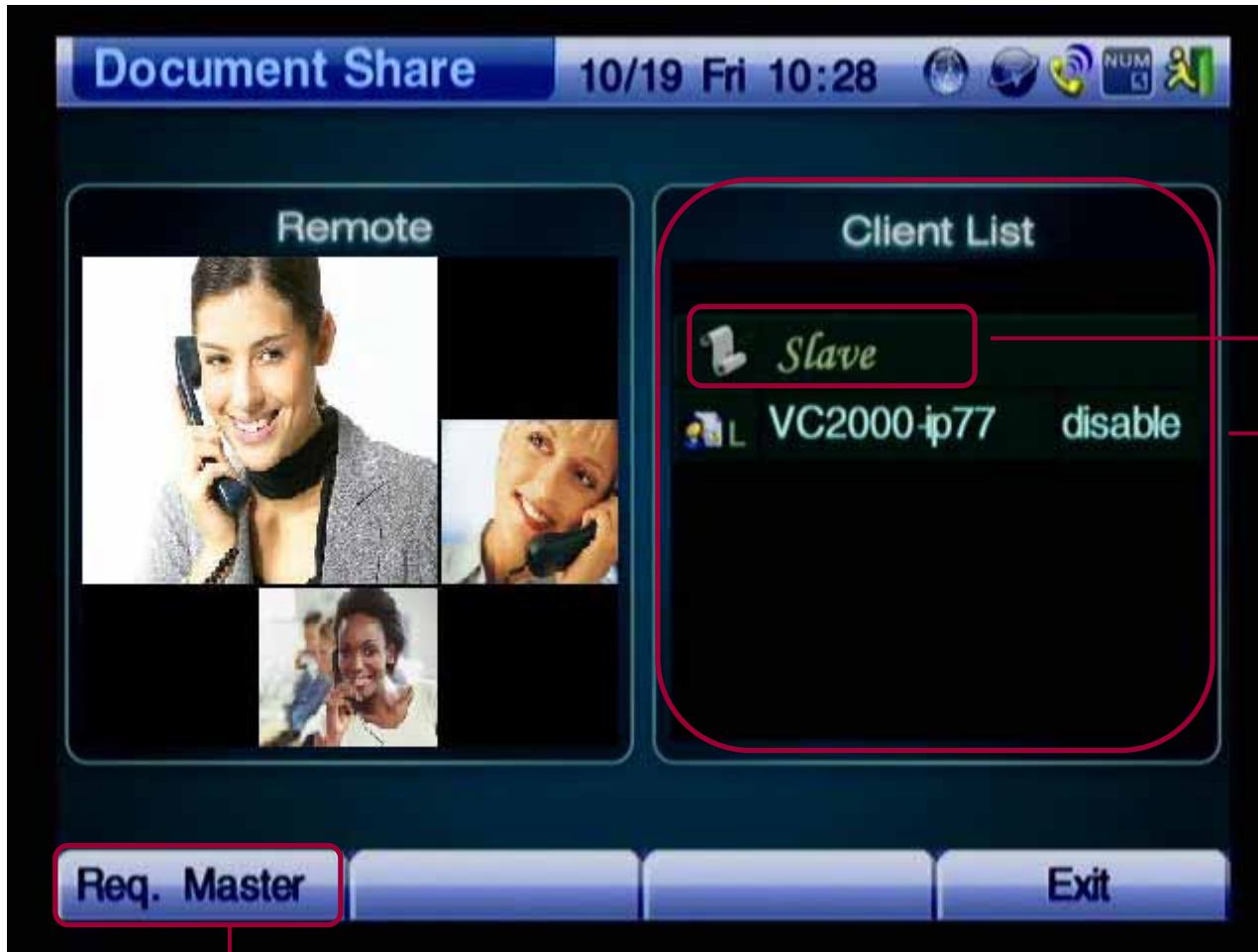

Slave Status Initially

Presentation Sources

Token Request to Start Presentation

AddPac

www.addpac.com

Master status



Master Status

Ready to activate

Activate a Client(Source)

Active Status



Master Status

Active Status

Now other terminals
can see a
presentation video
from this source

Deactivate a Client(Source)

H.239 Service Model

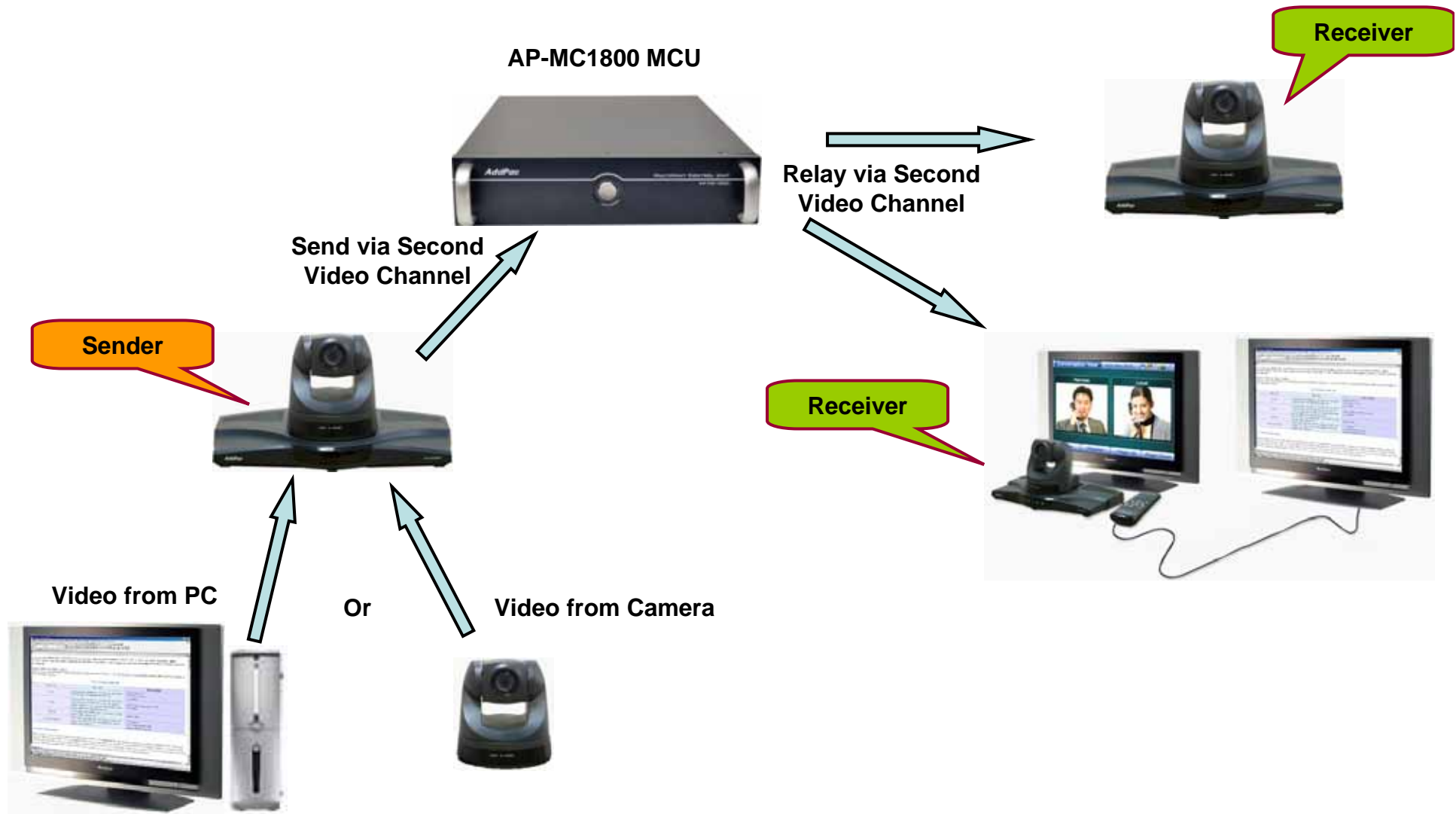

AddPac

www.addpac.com

H.239 Message Flow

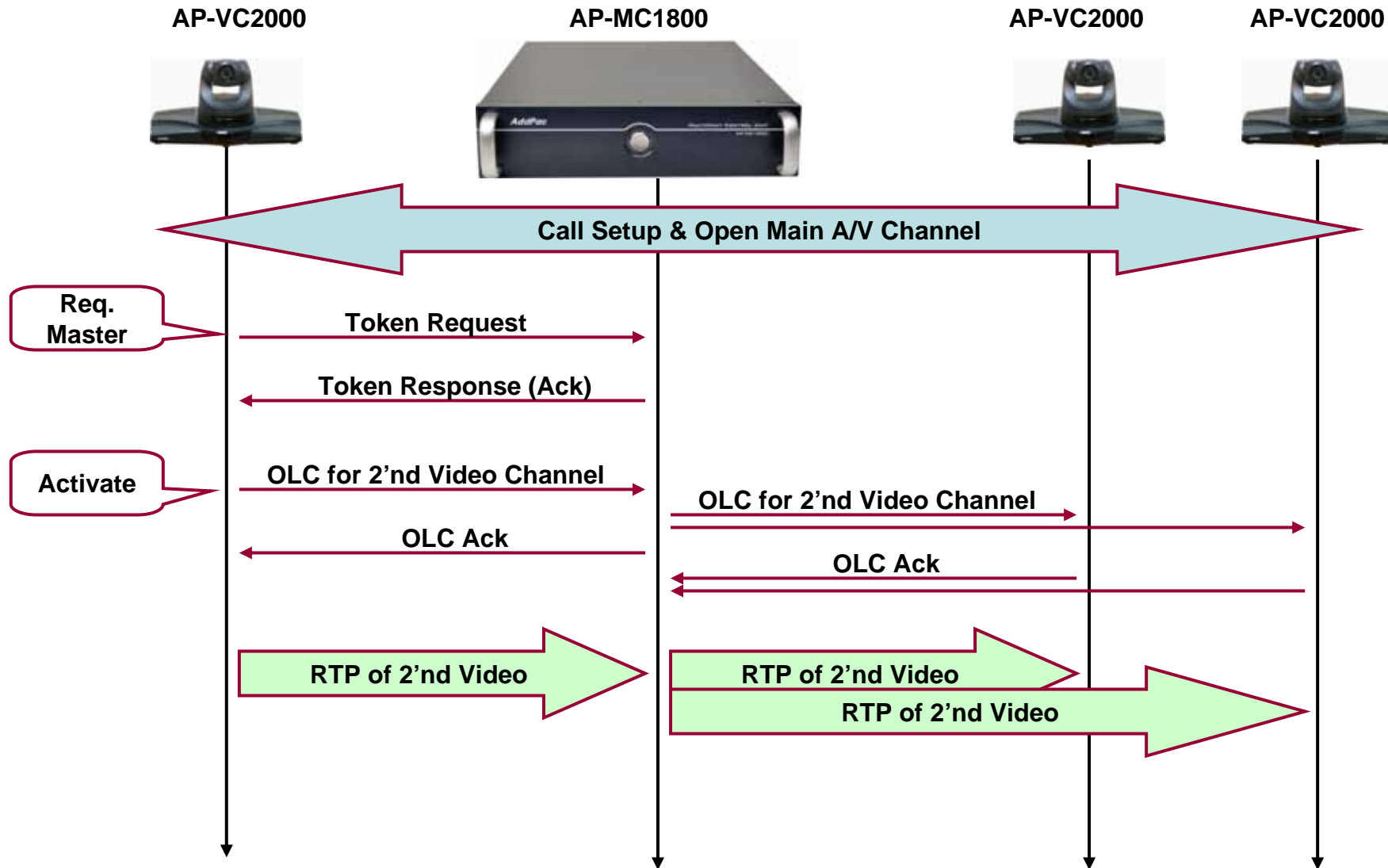

Compatibility Test

- **Tested Products for Compatibility**



Tandberg(TTC7-08)



Athera (Vega Star Silver)

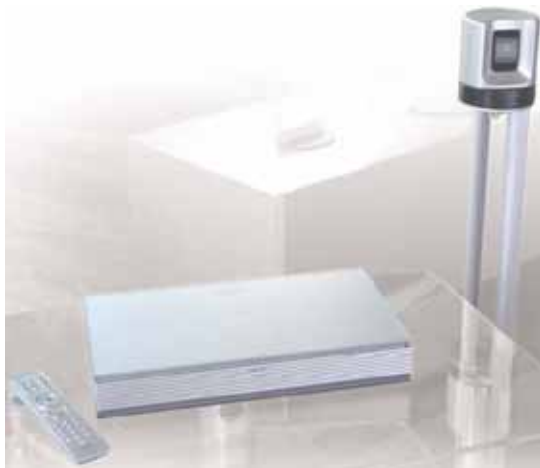

Sony(PCS-G50)



Emblaze-Vcon(vPoint 7.1)

Test Result

-: Not Supported, ?: Supported but Not Tested, O: Tested & Work, X: Tested but Not Work

Item		Tandberg	Sony	Vega Star	vPoint
Audio		O	O	O	O
Video		O	O	O	O
H.243	Chair	-	-	?	-
	Floor	O	-	?	-
H.239	Send	O	O	?	?
	Receive	O	O	?	?
FECC	Control	O	O	?	O
	Be controlled	O	O	?	?



Thank you!

AddPac Technology Co., Ltd.
Sales and Marketing

Phone +82.2.568.3848 (KOREA)

FAX +82.2.568.3847 (KOREA)

E-mail sales@addpac.com