

# Smart AV Controller Solution for Video Decoder



Smart AV Controller



**AddPac**

**AddPac Technology**

Sales and Marketing

[www.addpac.com](http://www.addpac.com)

# Contents

- Smart AV Controller Network Diagram
- Smart AV Controller Overview
- Smart AV Controller GUI Examples
  - Login Home
  - Dial Pad
- Default Web Page
- HD Video Codec Platform
- HD Video Codec Modules

# Smart AV Controller Network Diagram

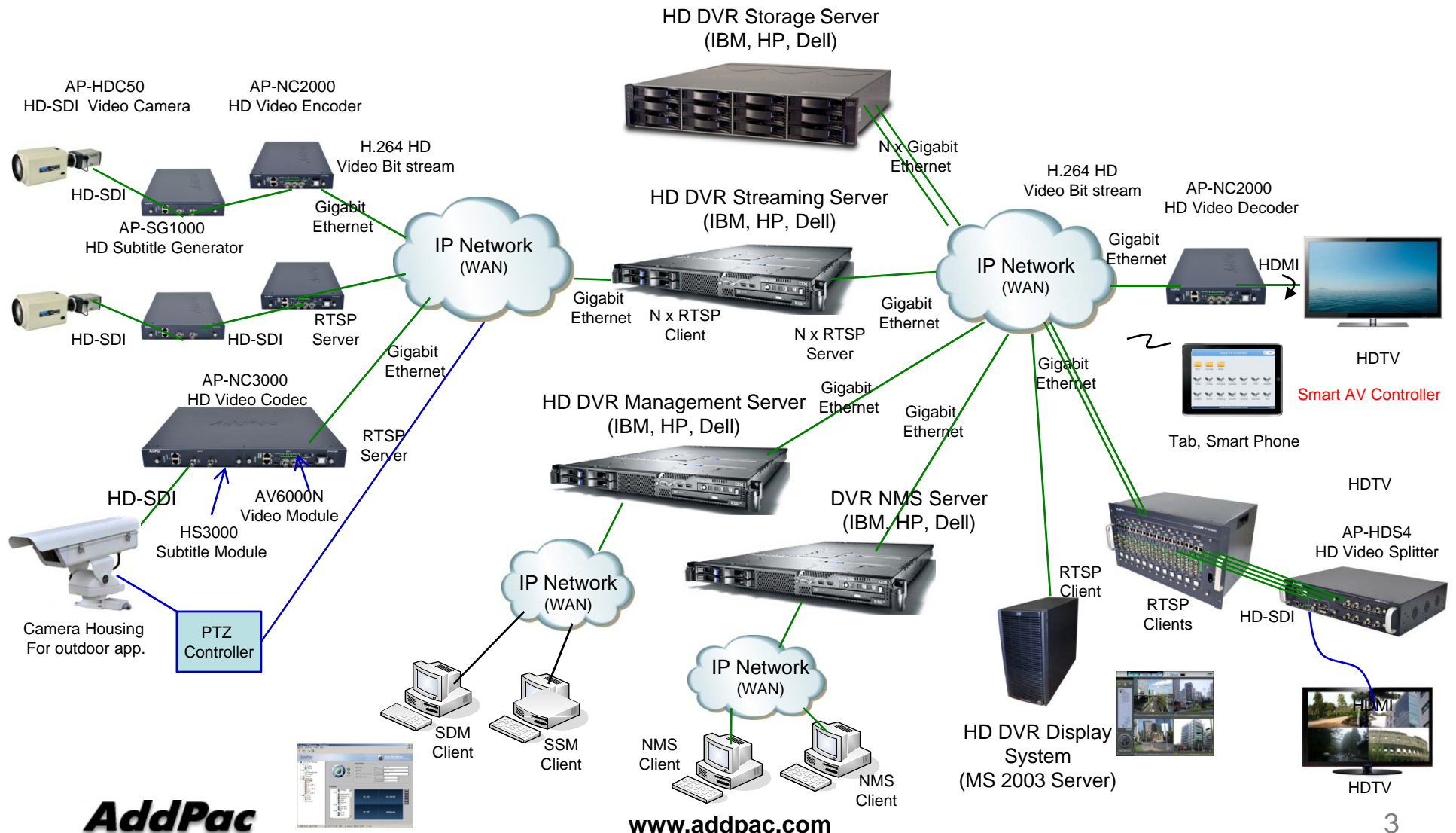

# Smart AV Controller Overview

- Pure Web based Smart Controller for AddPac Network DVR HD Video Decoder Control
- Support Various Web Brower
  - PC(or Notebook) based Internet Explorer, Chrome, etc
  - Android based Web Browser like as Galaxy Tab, etc
  - Safari Web Browser like as Apple IPAD, etc
- Landscape Orientation View Mode Optimized (Tab, IPAD)
- IP based Remote HD Video Decoder Control using PC(or Notebook), Tab, PAD, etc Instead of legacy IrDA Remote Controller by OSD

# Smart AV Controller Main Functions

Login Home



Camera(Video Encoder) Add



Decoder Sequence Display Start

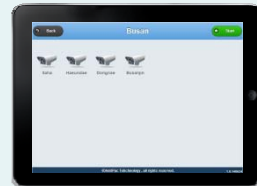

Camera Edit (Video Encoder Edit)



Decoder Sequence Display Stop

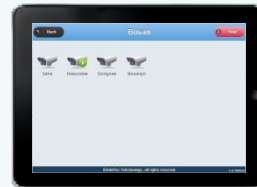

Decoder Sequence Display Add



Editing Mode



Decoder Sequence Display Edit



# Login Home

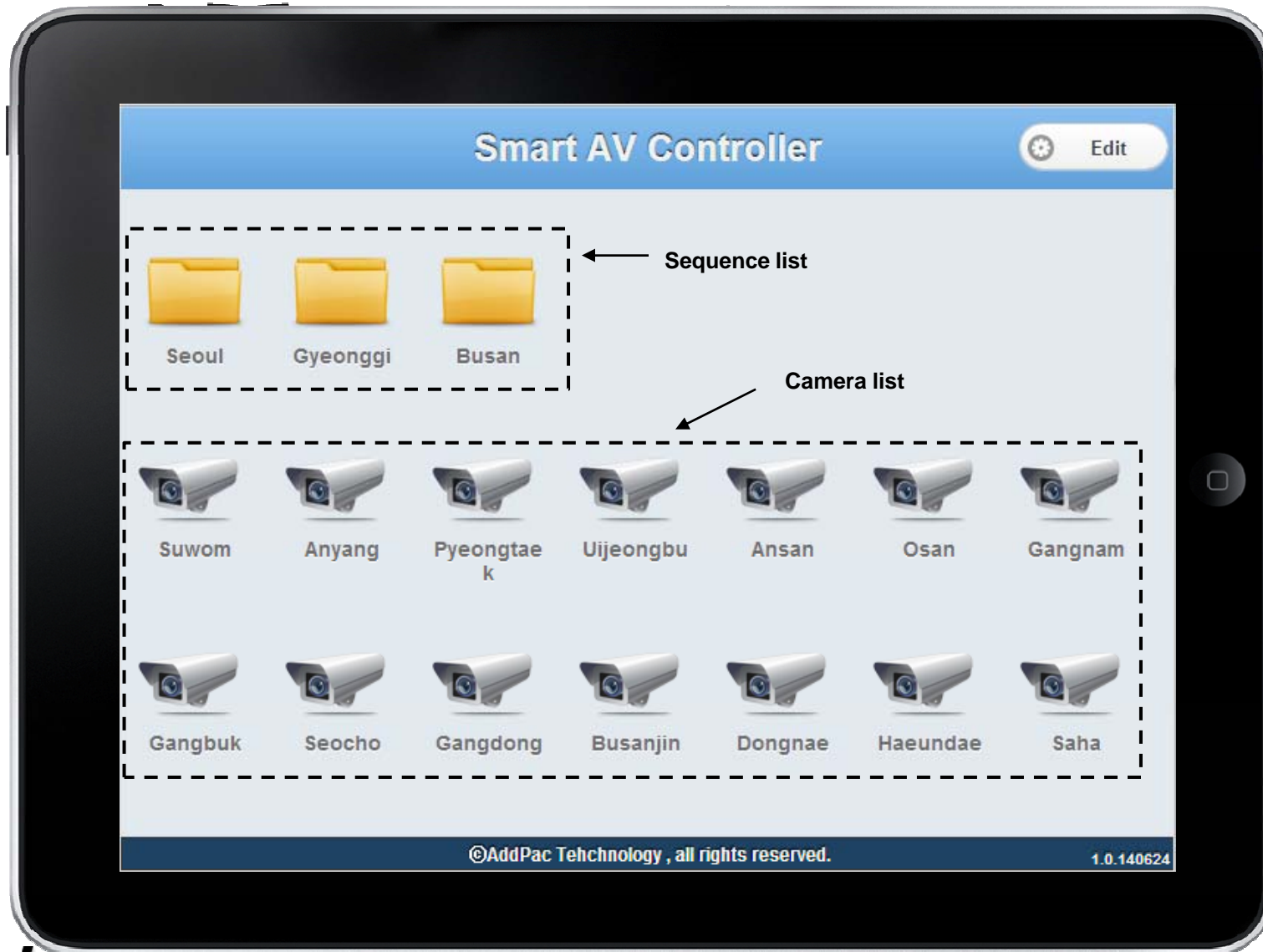

# Decoder Sequence Display Start

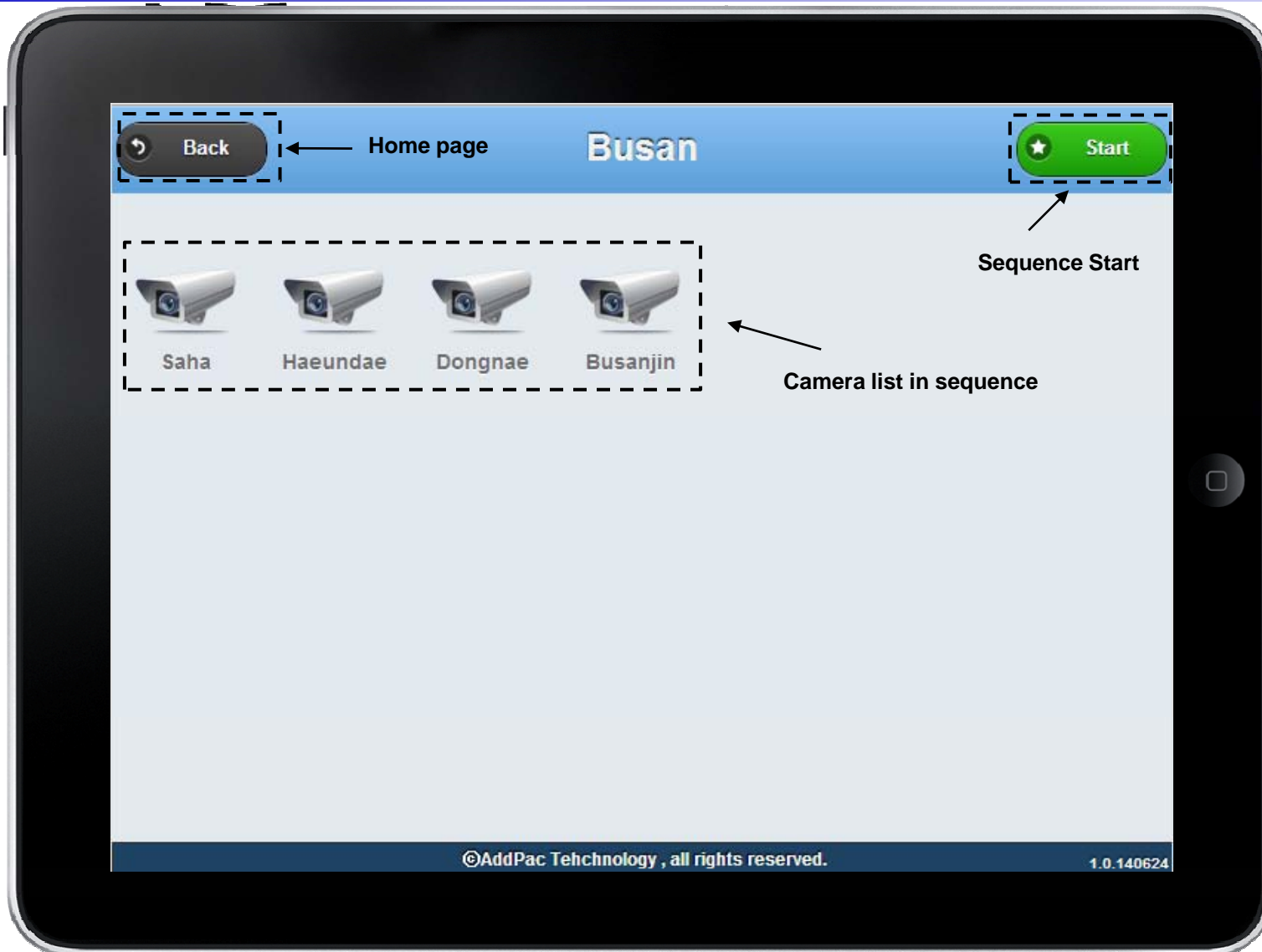

# Decoder Sequence Display Stop

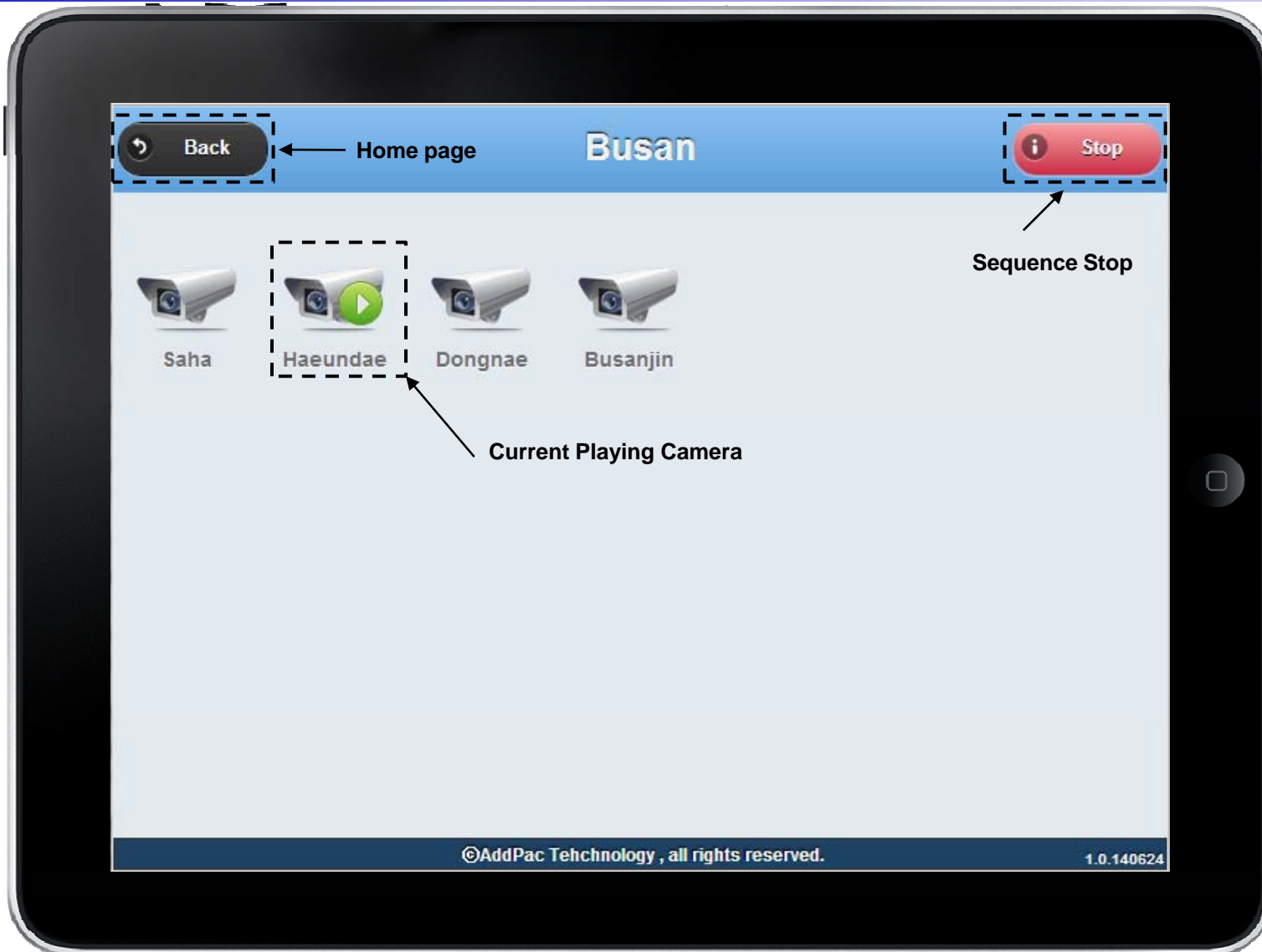



# Editing Mode

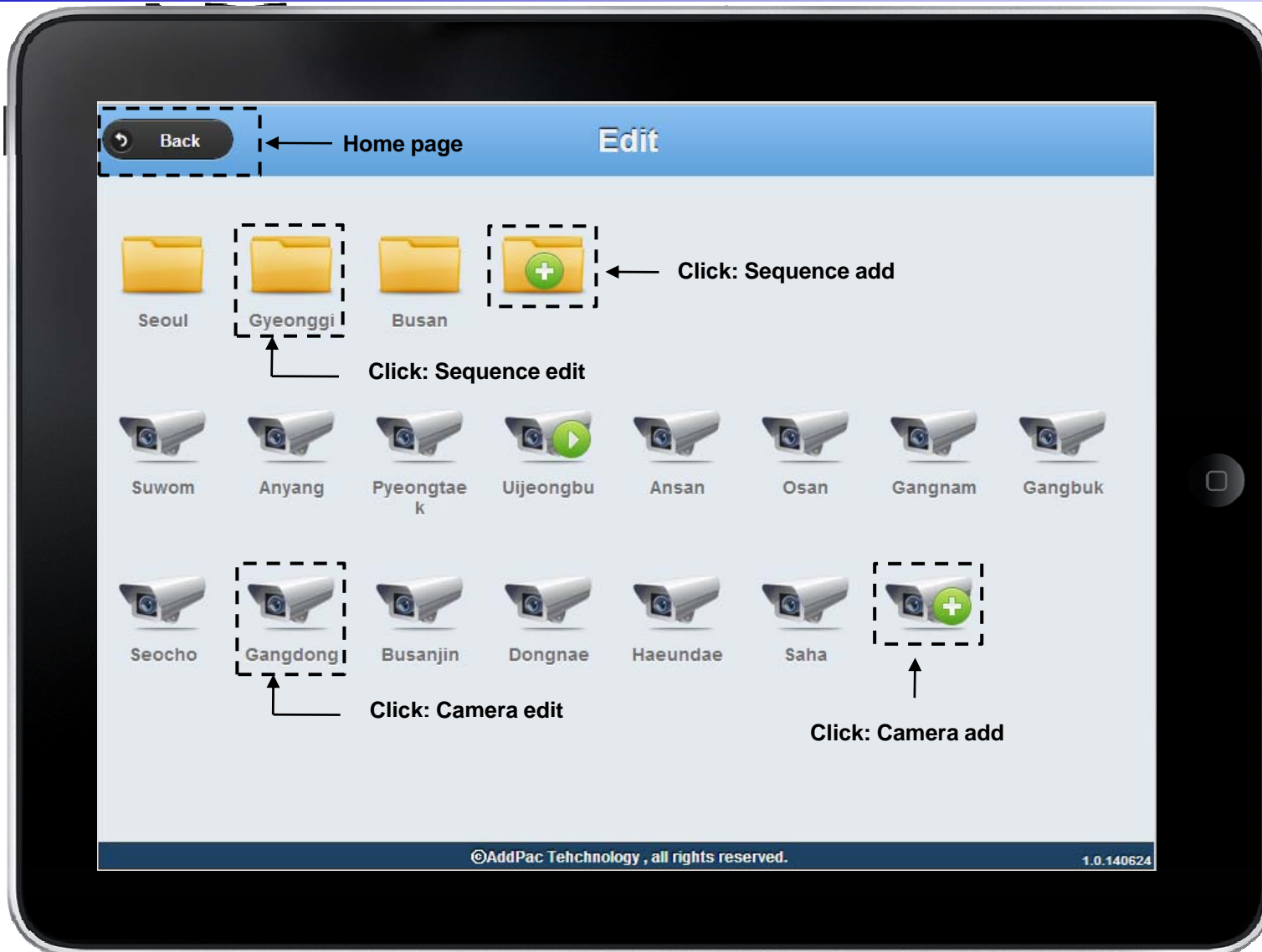

# Camera (Video Encoder) Add

Back Edit page Add Encoder OK

Save

Name \* Gangdong

Url \* rtsp://172.16.23.32/gangdong

Protocol \* RTP over RTSP

ID gangdong

Password .....

©AddPac Tehchnology , all rights reserved. 1.0.140624

# Camera (Video Encoder) Edit

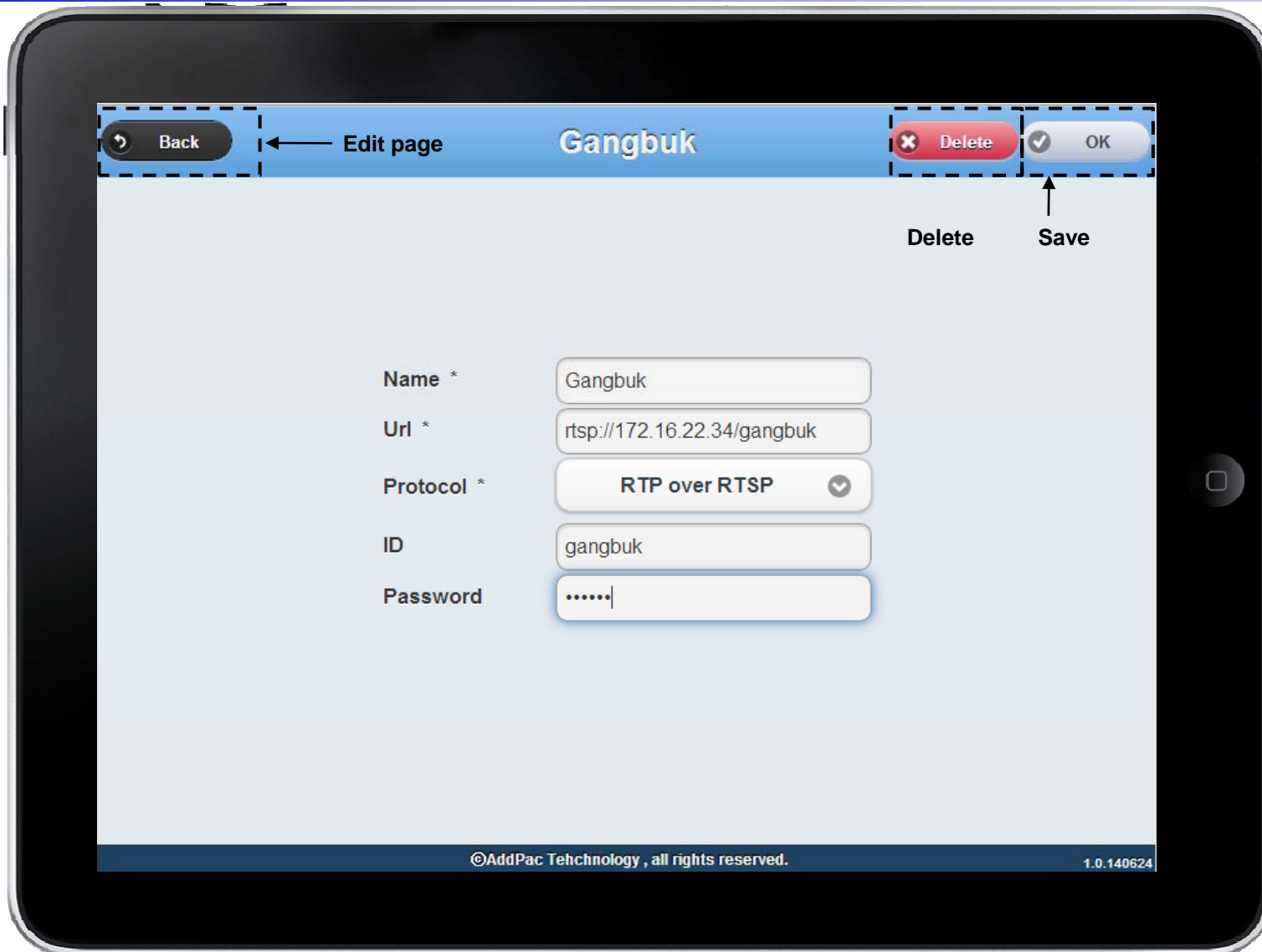

# Sequence Add

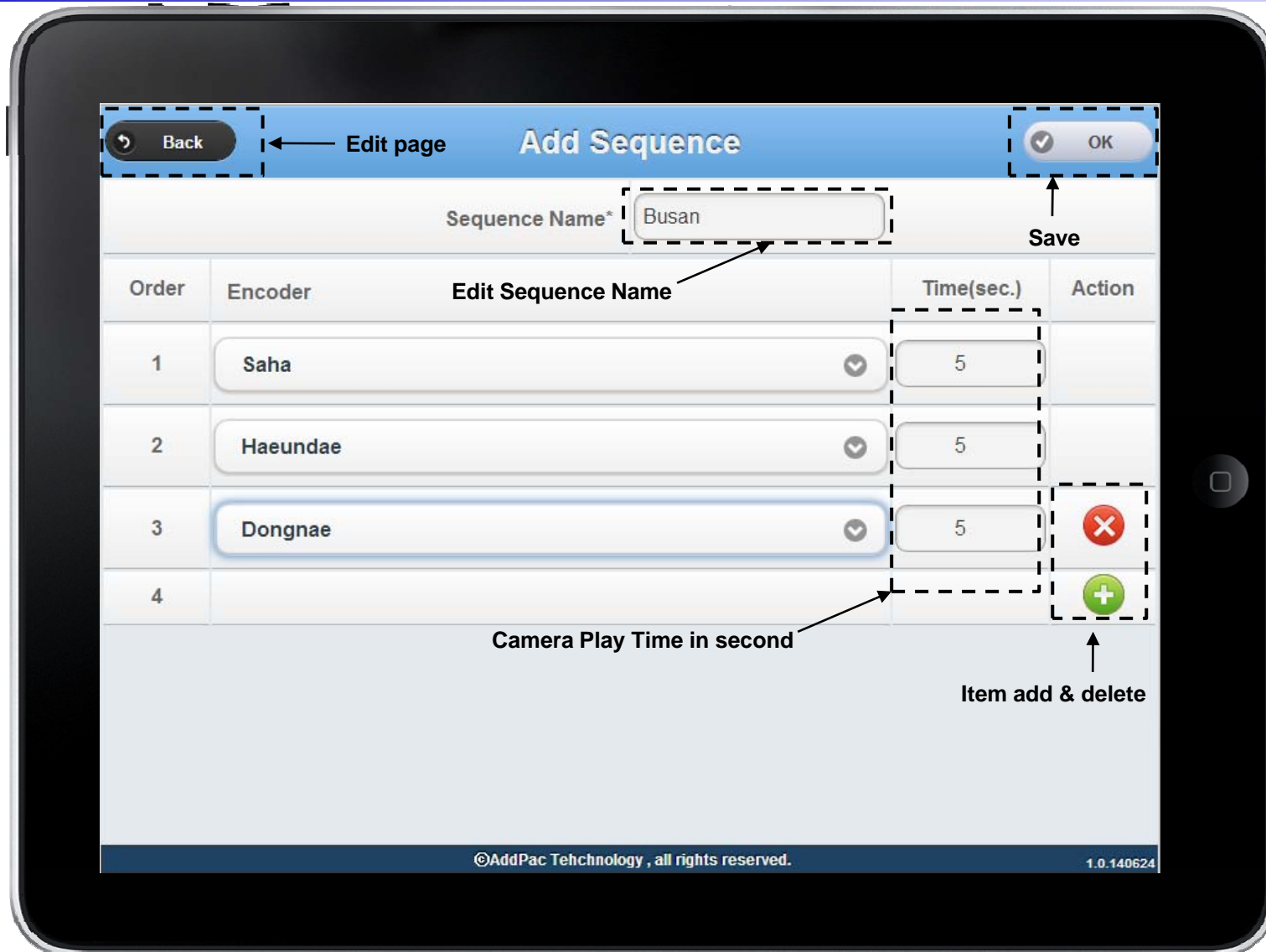

# Sequence Edit

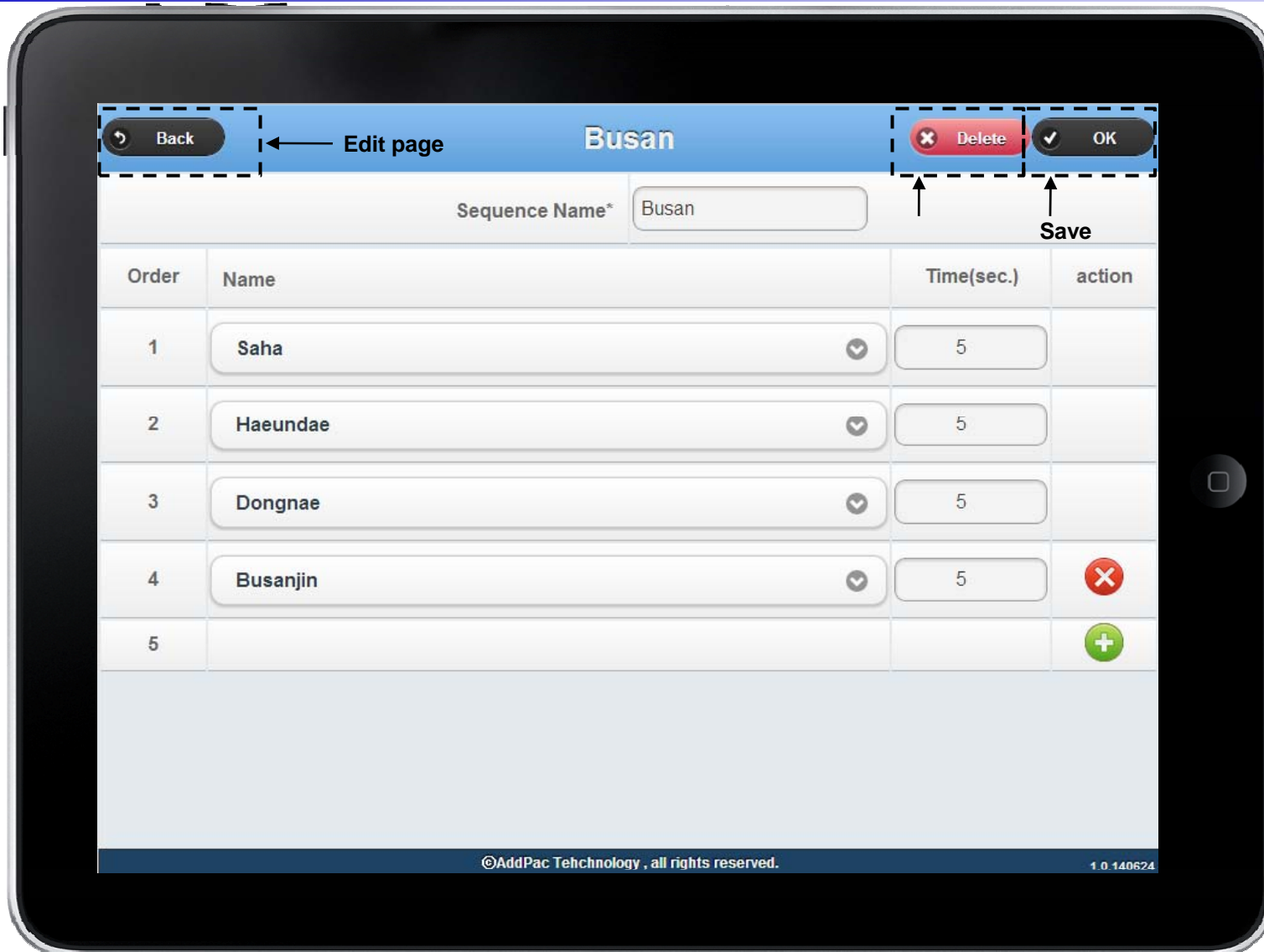

# Default web page





- Direct connection
  - ip\_address/**smartweb**
  - ip\_address/**smartcontroller**

The screenshot displays the 'Smart Web Manager' web interface. The left sidebar contains navigation menus for 'System', 'Basic', 'Advanced', and 'Miscellaneous'. The main content area is titled 'Service' and includes a table of application services with checkboxes for 'Enable Telnet', 'Enable HTTP', and 'Enable FTP', along with their respective server and control/data ports. Below this table, the 'Default web page' is set to 'AV Controller' (selected with a radio button), while 'Web Manager' is unselected. A dashed box highlights this section, with an arrow pointing to it and the text 'Default web page setting'. An 'Apply' button is visible at the bottom left of the configuration area. On the right, an 'Information' panel shows device details like 'AddPac Technology', 'Model: AV6000N\_G2', and 'Smart Web Version: 8.41.0.3'. A 'Description' panel at the bottom right explains the function of the service settings.



# HD Video Codec Platform

# HD Video Codec Platform Comparison Table

	AP-NC2000D	AP-NC2000	AP-NC3000	AP-NC3500	AP-NC5000
Model					
Module Slot	1 Module Slot	1 Module Slot	2 Module Slots	4 Module Slots	10 Module Slots
Power Supply	External Power Supply(DC)	Internal Power Module (AC)	Internal Power Module (AC)	Internal Power Module (AC)	Internal Power Module (AC)
Power Type	Power Adaptor	Built-In	Built-In	Module Type	Module Type





# AP-NC5000

## Multichannel HD Video Codec

# Main Features

- IP based Audio/Video Encoding/Decoding Solution
- Ten(10) Module Slots for HD Video Modules
- HD Video Encoder Modules
- HD Video Decoder Module
- IP based Network Surveillance Solution
- High-performance Video, Audio, and Voice Service
- Firmware Upgradeable Architecture
- Dual Power Supply Module for Redundancy
- Video Solution with Outstanding Network Service Capability
- Audio/Video Privacy Protection

# Hardware Specification

High-end  
DSP

- High-end Programmable DSP Hardware Architecture
- Ten(10) Video Module Slots
- HD Video Encoder/Decode Module (Ex : AV3000)
  - Network Interface
    - One(1) 10/100/1000Mbps Gigabit Ethernet
    - One(1) Console Port
  - Powerful Video Input/output Interface
    - HD-SDI, HDMI, Analog
  - High quality Audio and Voice Interface
    - Stereo Audio Input/Output Connector
  - Camera Control Interface
    - One(1) RS-232C, RS422, RS485 Interface for Camera Control
  - I/O Interface
    - 2 Alarm Input, 1 Relay
- Module Type Dual Power Supply

# Hardware Specification

High-end  
DSP

AP-NC5000 Front View



HD Video Encoder Module

Power Supply Module



# AP-NC3500

## Multichannel HD Video Codec

# Main Features

- IP based Audio/Video Encoding/Decoding Solution
- Four(4) Module Slots for HD Video Modules
- HD Video Encoder Module
- HD Video Decoder Module
- IP based Network Surveillance Solution
- High-performance Video, Audio, and Voice Service
- Firmware Upgradeable Architecture
- Video Solution with Outstanding Network Service Capability
- Internal Power Supply
- Audio/Video Privacy Protection

# Hardware Specification

High-end  
DSP

- High-end Programmable DSP Hardware Architecture
- Four(4) Video Module Slots
- HD Video Encoder/Decode Module (Ex : AV3000)
  - Network Interface
    - One(1) 10/100/1000Mbps Gigabit Ethernet
    - One(1) Console Port
  - Powerful Video Input/output Interface
    - HD-SDI, HDMI, Analog
  - High quality Audio and Voice Interface
    - Stereo Audio Input/Output Connector
  - Camera Control Interface
    - One(1) RS-232C, RS422, RS485 Interface for Camera Control
  - I/O Interface
    - 2 Alarm Input, 1 Relay
- Internal Power Supply

# Hardware Specification

High-end  
DSP

AP-NC3500 Front Side View



HD Video Encoder Module



# Hardware Specification

High-end  
DSP

## AP-NC3500 Back Side View





# AP-NC3000

## Two(2) Channel HD Video Codec

# Main Features

- IP based Audio/Video Encoding/Decoding Solution
- Two(2) Module Slots for HD Video Modules
- HD Video Encoder Module
- HD Video Decoder Module
- IP based Network Surveillance Solution
- High-performance Video, Audio, and Voice Service
- Firmware Upgradeable Architecture
- Video Solution with Outstanding Network Service Capability
- Internal Power Supply
- Audio/Video Privacy Protection

# Hardware Specification

High-end  
DSP

- High-end Programmable DSP Hardware Architecture
- Two(2) Video Module Slots
- HD Video Encoder/Decode Module (Ex : AV3000)
  - Network Interface
    - One(1) 10/100/1000Mbps Gigabit Ethernet
    - One(1) Console Port
  - Powerful Video Input/output Interface
    - HD-SDI, HDMI, Analog
  - High quality Audio and Voice Interface
    - Stereo Audio Input/Output Connector
  - Camera Control Interface
    - One(1) RS-232C, RS422, RS485 Interface for Camera Control
  - I/O Interface
    - 2 Alarm Input, 1 Relay
- Internal Power Supply

# Hardware Specification

High-end  
DSP

AP-NC3000 Front View



HD Video Encoder Module





# AP-NC2000

## One(1) Channel HD Video Codec

# Main Features

- IP based Audio/Video Encoding/Decoding Solution
- Single Slot for HD Video Modules
- HD Video Encoder Module
- HD Video Decoder Module
- IP based Network Surveillance Solution
- High-performance Video, Audio, and Voice Service
- Firmware Upgradeable Architecture
- Video Solution with Outstanding Network Service Capability
- Internal Power Supply
- Audio/Video Privacy Protection

# Hardware Specification

High-end  
DSP

- High-end Programmable DSP Hardware Architecture
- One(1) Video Module Slots
- HD Video Encoder/Decode Module (Ex : AV3000)
  - Network Interface
    - One(1) 10/100/1000Mbps Gigabit Ethernet
    - One(1) Console Port
  - Powerful Video Input/output Interface
    - HD-SDI, HDMI, Analog
  - High quality Audio and Voice Interface
    - Stereo Audio Input/Output Connector
  - Camera Control Interface
    - One(1) RS-232C, RS422, RS485 Interface for Camera Control
  - I/O Interface
    - 2 Alarm Input, 1 Relay
- Internal Power Supply



# Hardware Specification

High-end  
DSP

AP-NC2000 Front View



HD Video Encoder Module



# Hardware Specification

High-end  
DSP

AP-NC2000D Front View



AV3000 HD Video Encoder/Decoder Module





# Video Modules

# Video Modules

High-end  
DSP

AV6000N Full HD Video Codec Module  
(H.264 1080i, 720P Dual Encoding)



HS3000 HD-SDI Subtitle Generator Module





# Error Robust Full HD Video Codec Module AV6000N

# Product Overview

- Full HD (1080i) Video Encoding/Decoding Service Features
- Video Codec : H.264 HP/MP/BP AVC Video Codec
- **Robust H.264 Temporal Domain SVC(Scalable Video Codec) Support**
- Video Input Interface : HDMI, HD-SDI, Analog (NTSC, PAL)
- Video Output Interface : HDMI, HD-SDI, Analog (NTSC, PAL)
- Dual Bit Streaming Support
- RTSP/RTP, TCP/UDP Protocol Support
- IP based Network Surveillance Solution
- High-performance Video, Audio, and Voice Service
- Firmware Upgradeable Architecture
- Video Solution with Outstanding Network Service Capability
- Web based Management Service
- AP-NC2000D, AP-NC2000, AP-NC3000, AP-NC5000 Platform Available

# Hardware Specification

RISC  
CPU

High-End  
VP

- RISC + Video Processor Computing Power
- AV6000N Video Module
  - Network Interface
    - One(1) 10/100/1000Mbps Gigabit Ethernet
  - Video Interface
    - One(1) Channel HD-SDI Input
    - One(1) Channel HDMI Input
    - One(1) Channel CVBS Input or Output (selected by DIP Switch)
    - One(1) Channel HD-SDI Output
    - One(1) Channel HDMI Output
  - One(1) RS-232 Console Interface (RJ45)
  - Camera Control Interface
    - One(1) RS-232C, RS422, RS485 Interface for External Camera Control
  - I/O Interface
    - Two(2) Alarm Input /One(1) Relay Out

# Hardware Specification

RISC  
CPU

High-End  
VP

## Hardware Module Specification

AV6000N HD Video Encoder/Decoder Module(H.264)

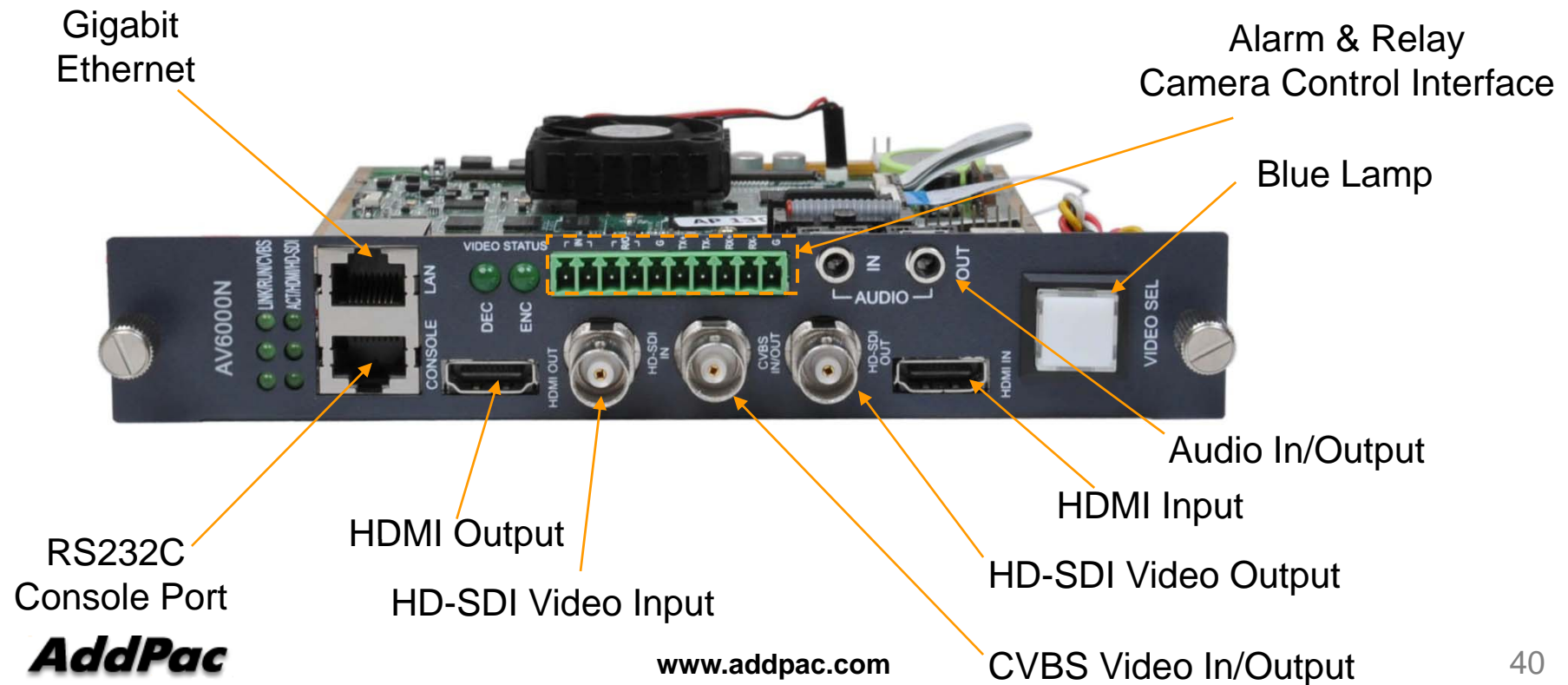



# Hardware Specification

## Hardware Specification

AP-NC2000D Front View



AV6000N HD Video Module



Power On/Off Switch  
[www.addpac.com](http://www.addpac.com)

DC Power Supply

# Software Service

- Built-in AddPac APOS Internetworking Software
  - Scalability, Functionality, and Stability Features
  - Full HD Video Encoding/Decoding Service Features
  - Video Upscale and Downscaling Service
- Firmware Upgradeable Architecture
- Industry Standard Network Protocol Features
- Highly User Friendly Management Features
  - Smart DVR Manager
  - Telnet or RS-232C based Command Line Interface

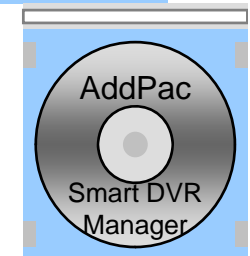
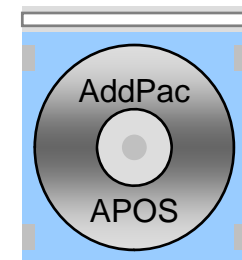

# Concurrent Triple Bit Stream Matrix

## Triple Video Encoding Bit Stream Matrix

Video Input	Concurrent Video Encoding Bit Stream			
	CIF	D1	HD(720P)	FULL HD (1080i)
Analog Video Input (NSTC/PAL)	Available	Available	N/A	N/A
HD-SDI Video Input (720P)	Option	Available	Available	N/A
HD-SDI Video Input (1080i)	Option	Available	Available	Available

# RTSP Service Network Diagram

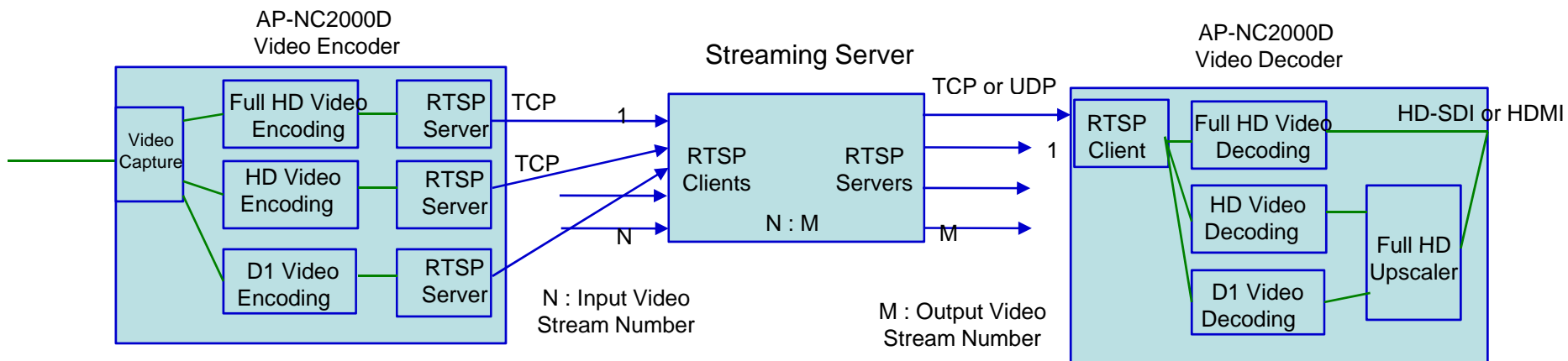
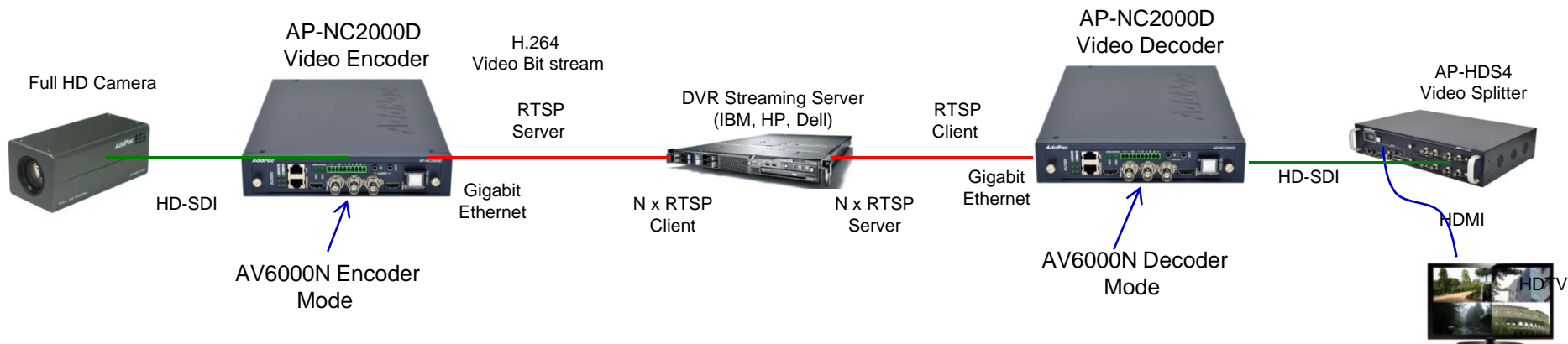

Example (N : M = 64 : 128)

# RTSP Service Features

- AV6000N Video Encoder Mode
  - RTSP Server Mode
  - Multi-Channel RTSP Server Mode  
(Full HD, HD, D1 Triple Encoding Mode or Dual Full HD, HD, etc)
  - RTSP, TCP Protocol Support for Error Robust Service
- AV6000N Video Decoder Mode
  - RTSP Client Mode
  - RTSP/TCP or RTSP/UDP Mode Support

# Video Codec Service Features

- AV6000N Video Encoder Mode
  - H.264 Full HD(1080i) Single Encoding (HD-SDI Input)
  - H.264 HD(720P) Single Encoding (HD-SDI Input)
  - H.264 D1(720x480) Single Encoding(Analog Input, HD-SDI Input 720P)
  - H.264 Full HD, HD Dual Encoding(HD-SDI Input)
  - **H.264 Full HD, HD, D1 Triple Encoding (HD-SDI Input)**
  - H.264 Full HD, D1 Dual Encoding (HD-SDI Input)
  - H.264 HD, D1 Dual Encoding (HD-SDI Input)
- AV6000N Video Decoder Mode
  - H.264 Full HD
  - H.264 HD, Upscale to Full HD
  - H.264 D1, Upscale to Full HD

# Video Codec Service Features

AP-NC2000D  
Video Encoder

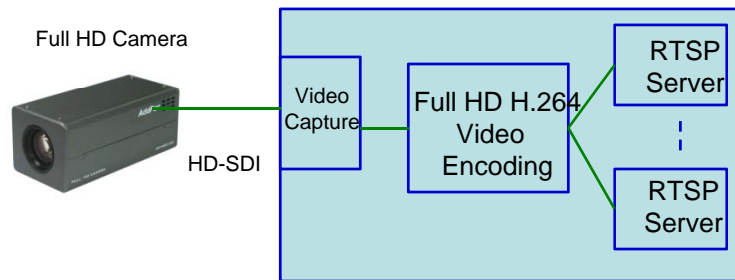

Single Full HD H.264 Video Encoding

AP-NC2000D  
Video Encoder

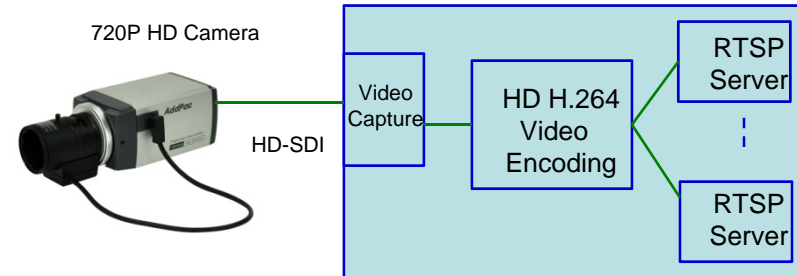

Single HD H.264 Video Encoding

AP-NC2000D  
Video Encoder

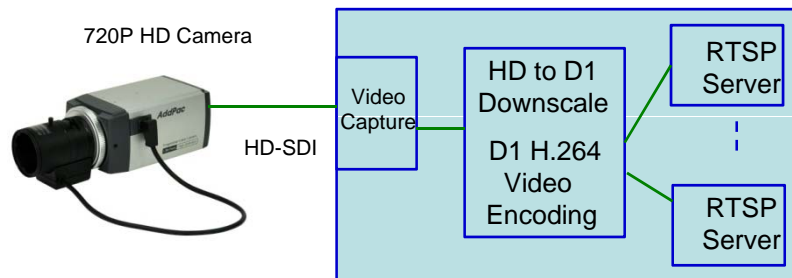

Single D1 H.264 Video Encoding

AP-NC2000D  
Video Encoder

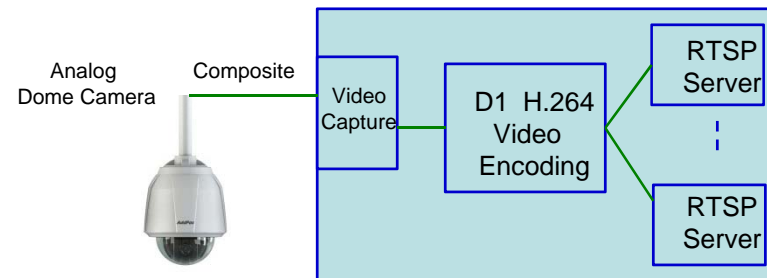

Single D1 H.264 Video Encoding

# Video Codec Service Features

AP-NC2000D  
Video Encoder

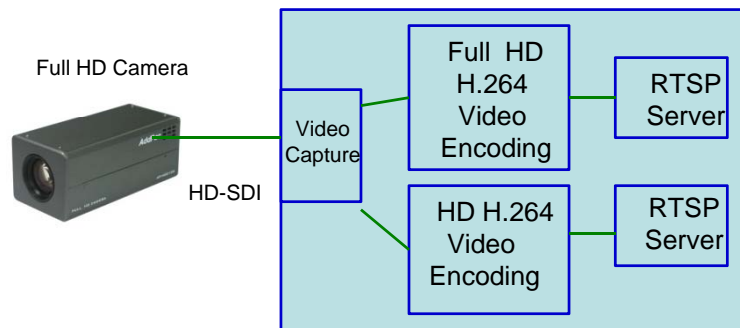

H.264 Full HD, HD Dual Video Encoding

AP-NC2000D  
Video Encoder

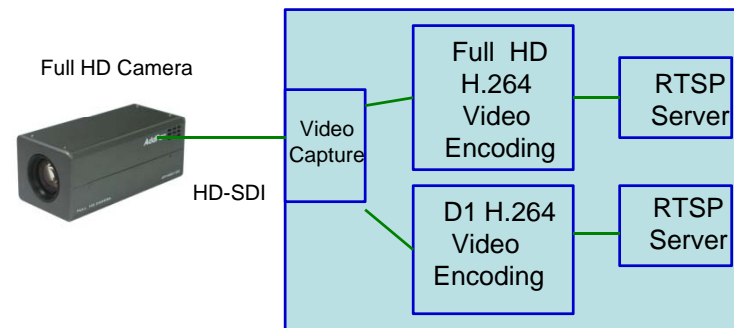

H.264 Full HD, D1 Dual Video Encoding

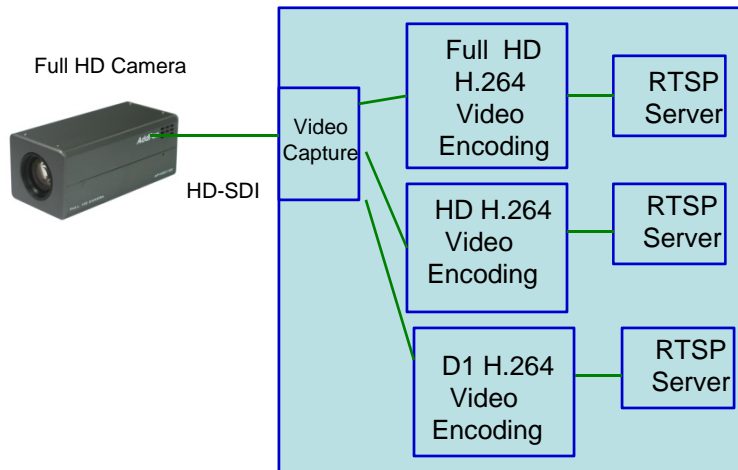

H.264 Full HD, HD, D1 Triple Video Encoding

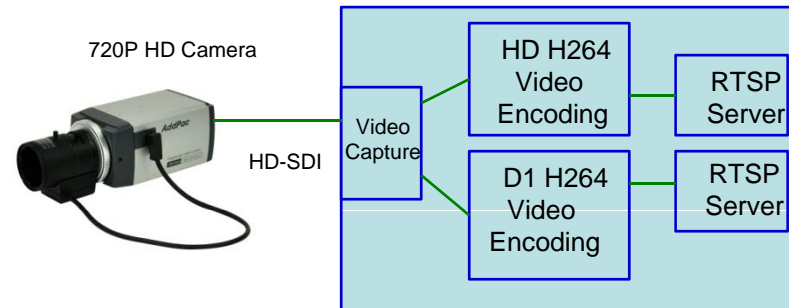

H.264 HD, D1 Dual Video Encoding



# Temporal Domain SVC Overview

## Encoding/Decoding Order for Hierarchical-P

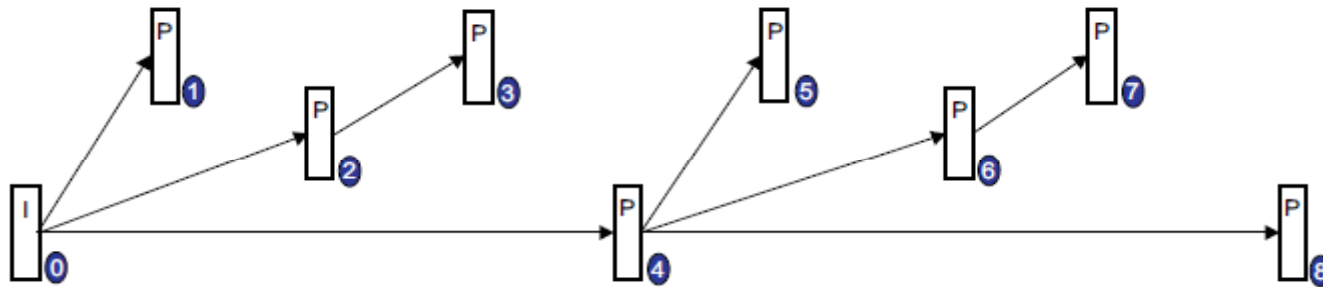

## Temporal Layers

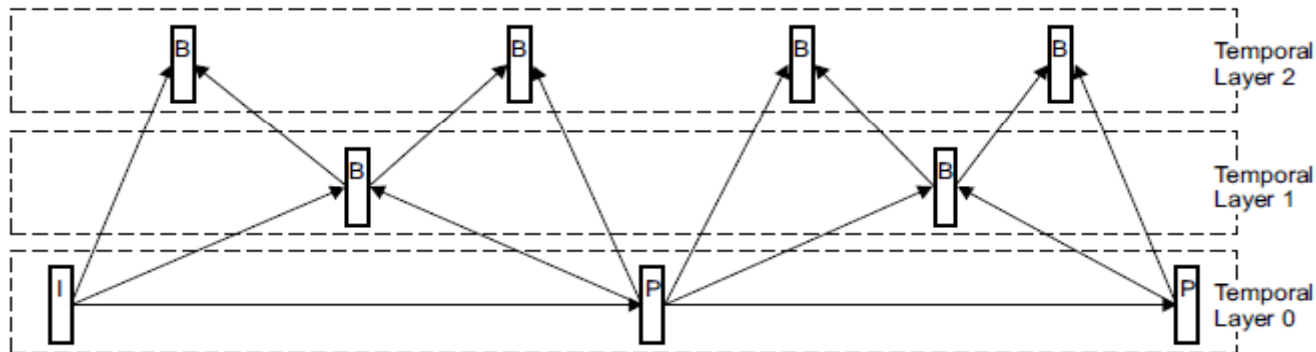

## Prefix NAL Unit Syntax as Specified by SVC

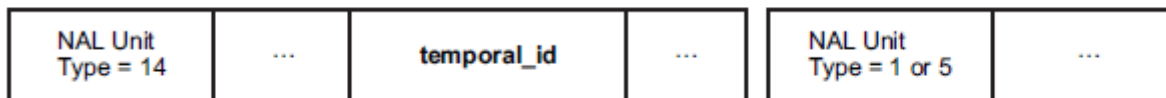

Prefix NAL Unit

H.264/AVC NAL Unit

# Temporal Domain SVC Overview

## SVC: temporal scalability scenario

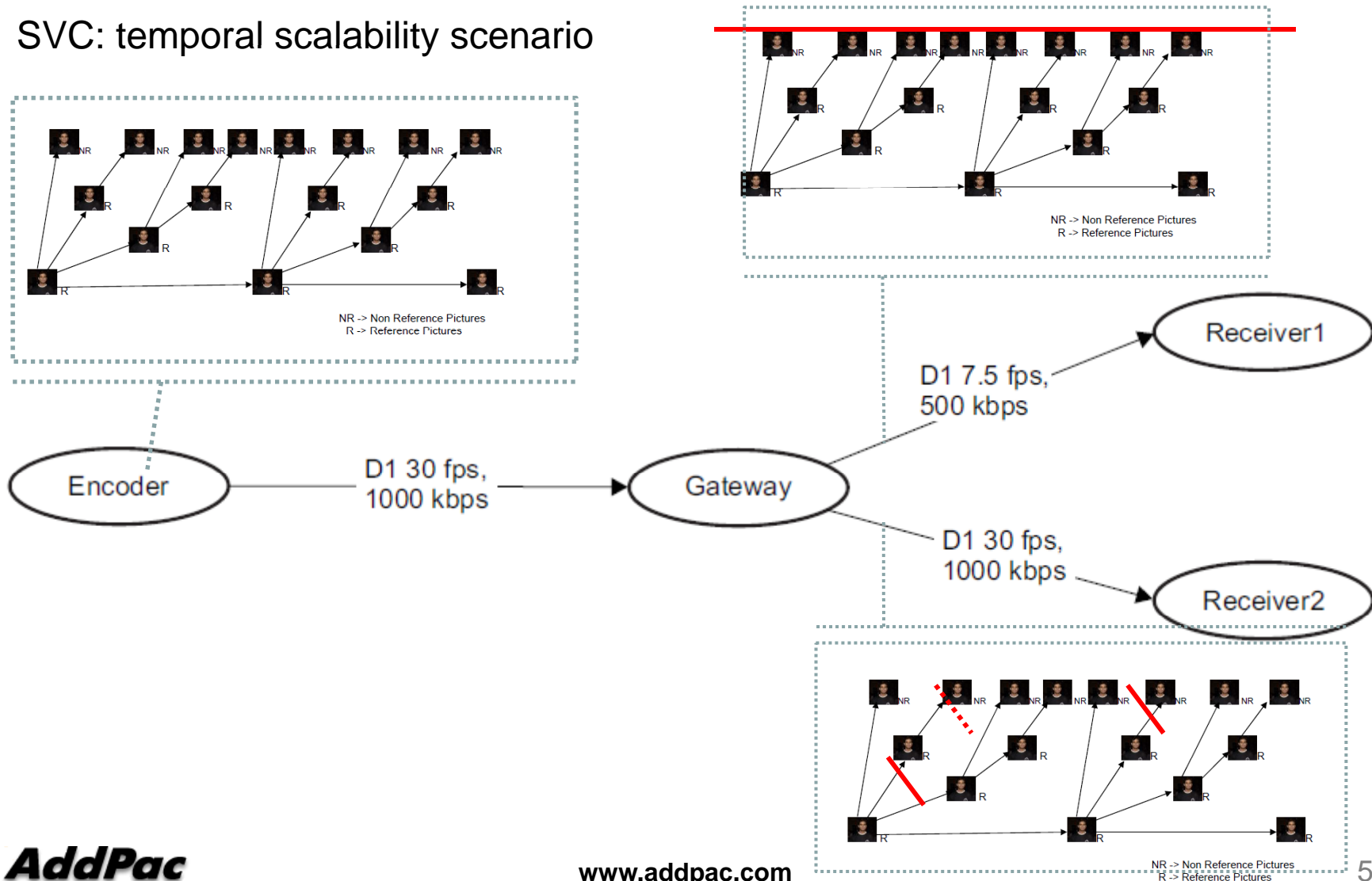



# HS3000

## HD Subtitle Generator Module

# HS3000 HD Subtitle Generator Modules

High-end  
DSP

## Main Features

- HD-SDI Subtitle Generation Service Features
- PC based Subtitle Controller Software
- High-end Video Processor Architecture
- One(1) 10/100/1000Mbps Gigabit Ethernet Interface
- One(1) RS232C Command Line Interface(RJ45)
- IP based Network Surveillance Solution
- High-performance Video, Audio, and Voice Service
- Firmware Upgradeable Architecture
- Video Solution with Outstanding Network Service Capability
- Audio/Video Privacy Protection

# HS3000 HD Subtitle Generator Modules

High-end  
DSP

## Hardware Specification

- High-end Video Processor Architecture
- Network Interface
  - One(1) 10/100/1000Mbps Gigabit Ethernet (RJ45)
- Command Line Interface
  - One(1) RS-232C Interface (RJ45)
- Video Interface
  - Video Input : 1 Channel Video Input (HD-SDI)
  - Video Output : 1 Channel Video Output (HD-SDI)

# HS3000 HD Subtitle Generator Modules

High-end  
DSP

## HS3000 HD-SDI Subtitle Generator Module Specification

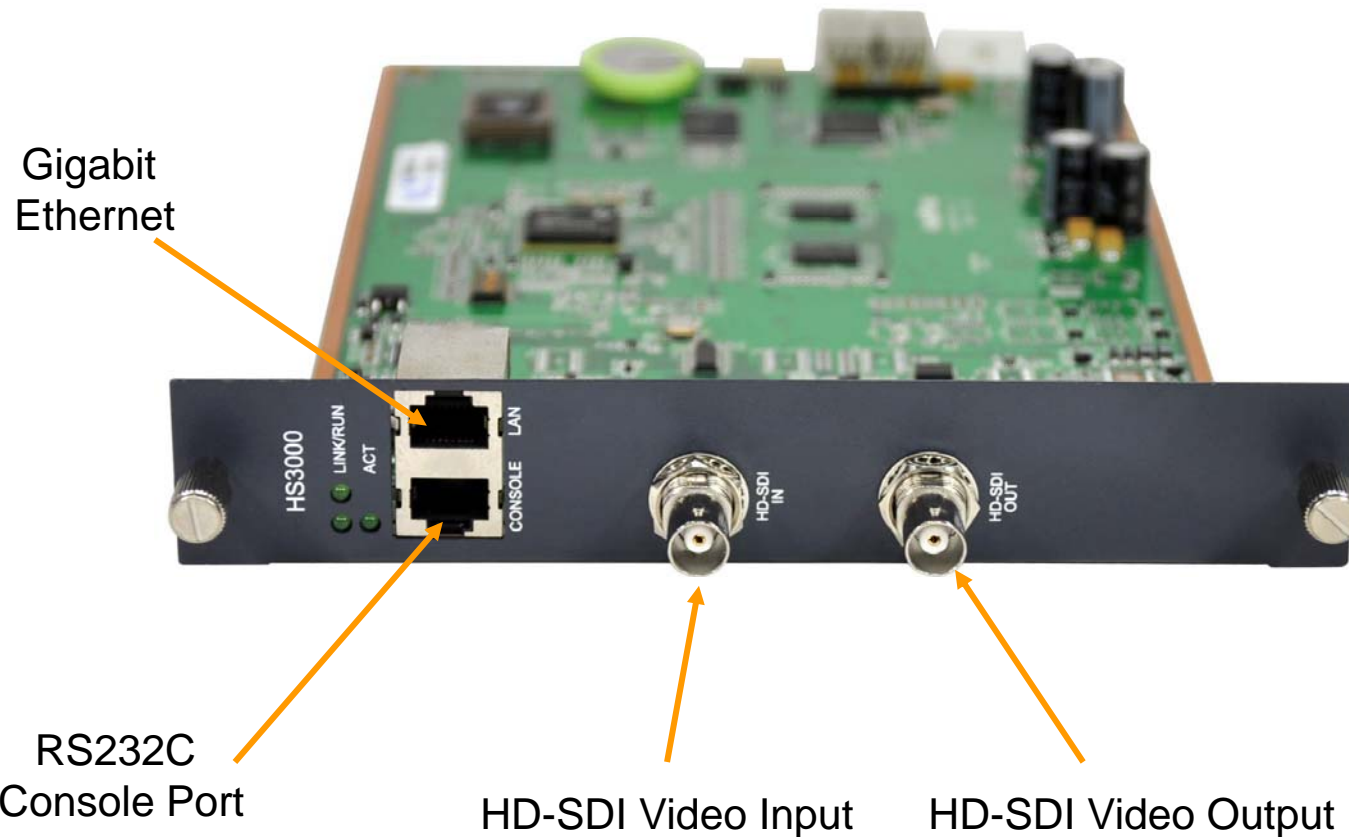



# Thank you!

AddPac Technology Co., Ltd.  
Sales and Marketing

Phone +82.2.568.3848 (KOREA)

FAX +82.2.568.3847 (KOREA)

E-mail [sales@addpac.com](mailto:sales@addpac.com)