

AV6000

Full HD Video Codec Module High-performance Network HD DVR Solution

Preliminary Product Overview

(Without notice, following described technical spec. can be changed)



AddPac

AddPac Technology

Sales and Marketing

www.addpac.com

Contents

- Product Overview
- Hardware Specification
- Software Service
- Concurrent Triple Bit-Stream Matrix
- RTSP Service Network Diagram
- RTSP Service Features
- Video Codec Service Features
- Network Service and Features
- Ordering Information

Product Overview

AV6000 Full HD Video Codec Module

- Full HD (1080i) Video Encoding/Decoding Service Features
- Video Codec : H.264 HP/MP/BP
- Video Input Interface : HDMI, HD-SDI, Analog (NTSC, PAL)
- Video Output Interface : HDMI, HD-SDI, Analog (NTSC, PAL)
- Dual Bit Streaming Support
- RTSP/RTP, TCP/UDP Protocol Support
- IP based Network Surveillance Solution
- High-performance Video, Audio, and Voice Service
- Firmware Upgradeable Architecture
- Video Solution with Outstanding Network Service Capability
- Web based Management Service
- AP-NC2000D, AP-NC2000, AP-NC3000, AP-NC5000 Platform Available

Hardware Specification

AV6000 Full HD Video Codec Module

RISC
CPU

High-End
VP

- **RISC + Video Processor Computing Power**
- **AP-AV6000 Video Module**
 - **Network Interface**
 - One(1) 10/100/1000Mbps Gigabit Ethernet
 - **Video Interface**
 - One(1) Channel HD-SDI Input
 - One(1) Channel HDMI Input
 - One(1) Channel CVBS Input or Output (selected by DIP Switch)
 - One(1) Channel HD-SDI Output
 - One(1) Channel HDMI Output
 - **One(1) RS-232 Console Interface (RJ45)**
 - **Camera Control Interface**
 - One(1) RS-232C, RS422, RS485 Interface for External Camera Control
 - **I/O Interface**
 - Two(2) Alarm Input /One(1) Relay Out

Hardware Specification

AV6000 Full HD Video Codec Module

RISC
CPU

High-End
VP

Hardware Module Specification

AV6000 HD Video Encoder/Decoder Module(H.264)

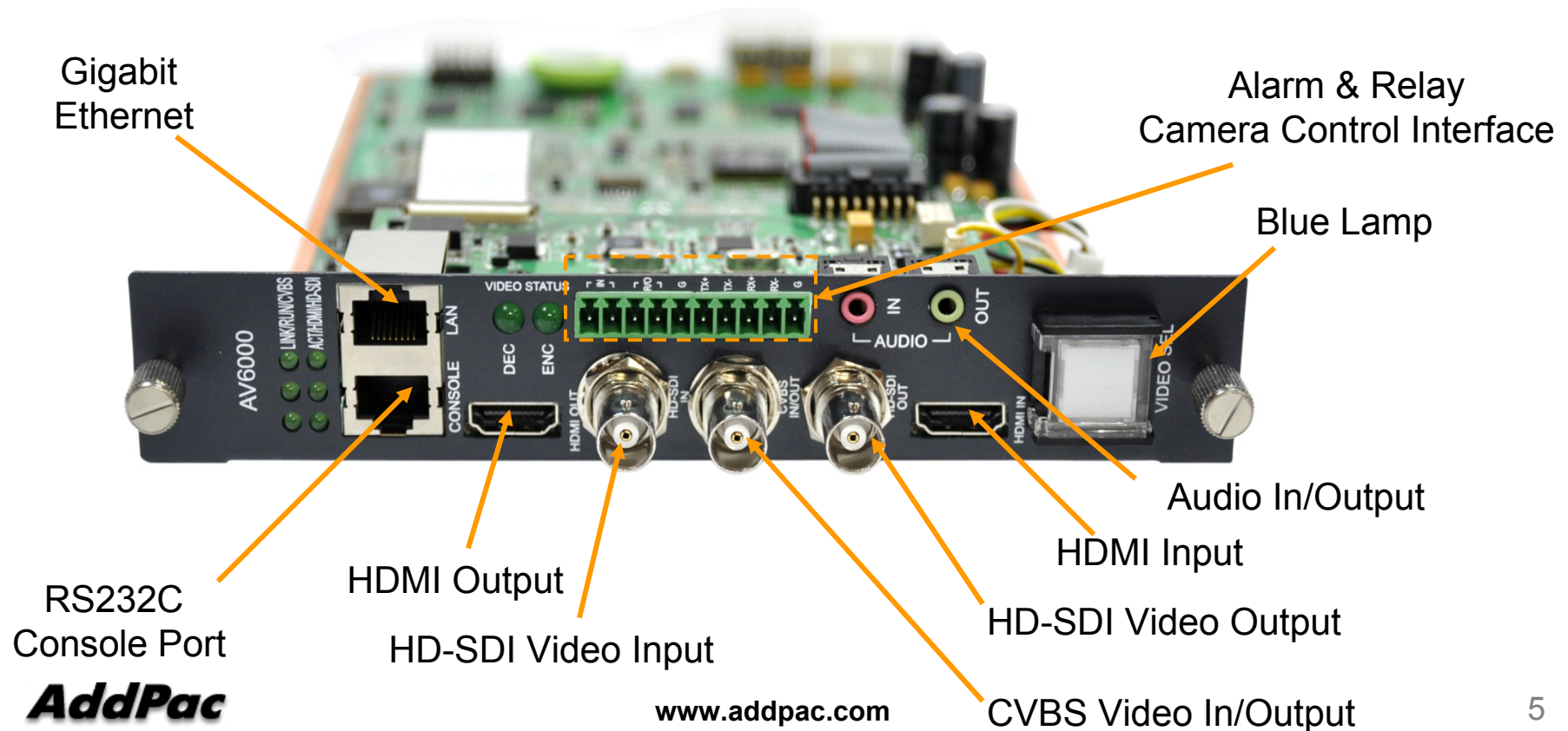

Hardware Specification

AV6000 Full HD Video Codec Module

Hardware Specification

AP-NC2000D Front View



AV6000 HD Video Module



Power On/Off Switch
www.addpac.com

DC Power Supply

Software Service

AV6000 Full HD Video Codec Module

- **Built-in AddPac APOS Internetworking Software**
 - Scalability, Functionality, and Stability Features
 - Full HD Video Encoding/Decoding Service Features
 - Video Upscale and Downscaling Service
- **Firmware Upgradeable Architecture**
- **Industry Standard Network Protocol Features**
- **Highly User Friendly Management Features**
 - Smart DVR Manager
 - Telnet or RS-232C based Command Line Interface

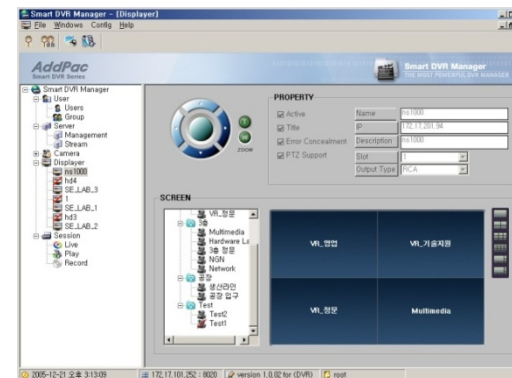
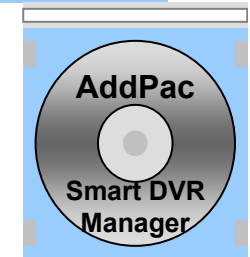
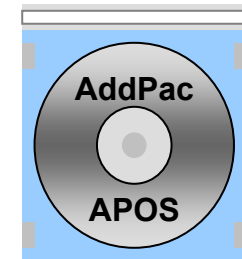

Concurrent Triple Bit Stream Matrix

AV6000 Full HD Video Codec Module

Triple Video Encoding Bit Stream Matrix

Video Input	Concurrent Video Encoding Bit Stream			
	CIF	D1	HD(720P)	FULL HD (1080i)
Analog Video Input (NSTC/PAL)	Available	Available	N/A	N/A
HD-SDI Video Input (720P)	Option	Available	Available	N/A
HD-SDI Video Input (1080i)	Option	Available	Available	Available

RTSP Service Network Diagram

AV6000 Full HD Video Codec Module

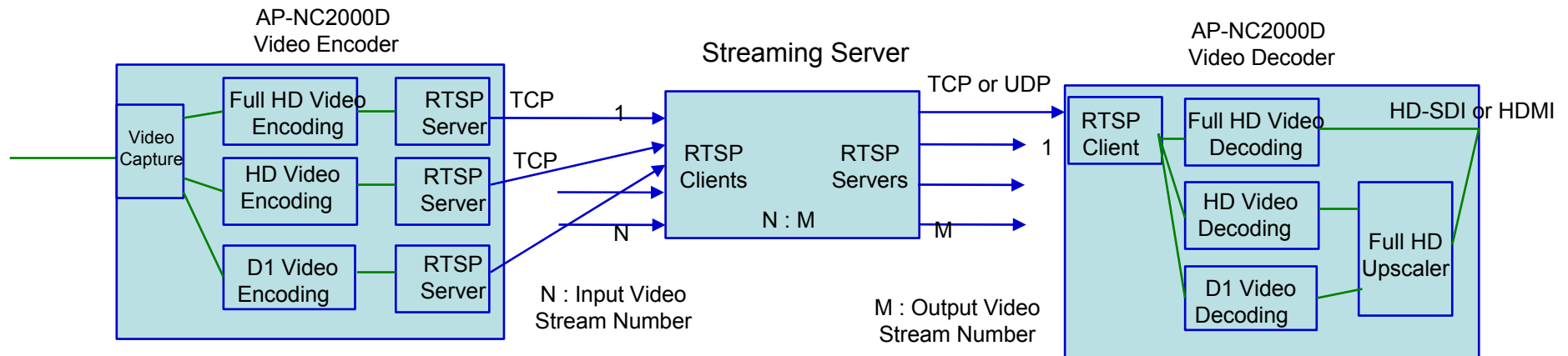
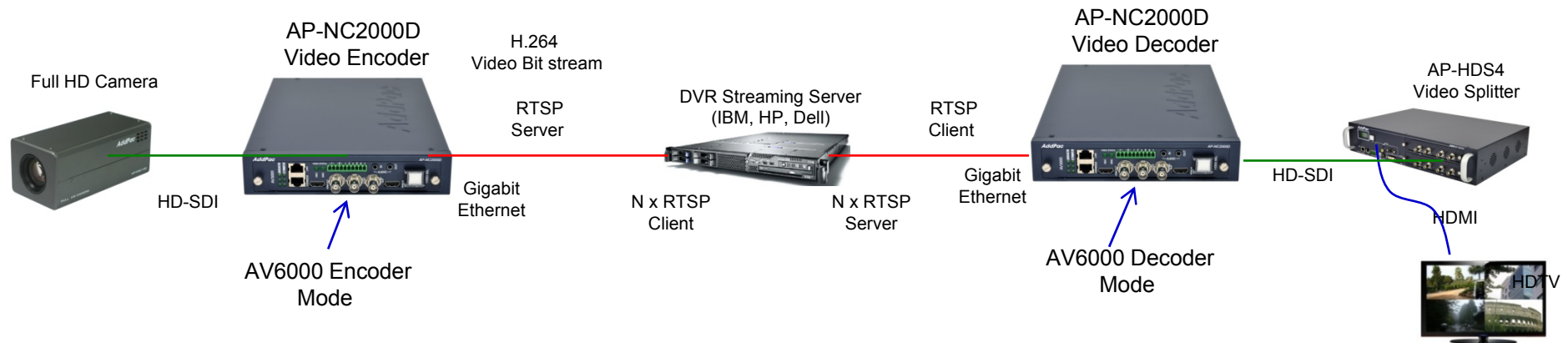

Example (N : M = 64 : 128)

RTSP Service Features

AV6000 Full HD Video Codec Module

- AV6000 Video Encoder Mode
 - RTSP Server Mode
 - Multi-Channel RTSP Server Mode
(Full HD, HD, D1 Triple Encoding Mode or Dual Full HD, HD, etc)
 - RTSP, TCP Protocol Support for Error Robust Service
- AV6000 Video Decoder Mode
 - RTSP Client Mode
 - RTSP/TCP or RTSP/UDP Mode Support

Video Codec Service Features

AV6000 Full HD Video Codec Module

- AV6000 Video Encoder Mode
 - H.264 Full HD(1080i) Single Encoding (HD-SDI Input)
 - H.264 HD(720P) Single Encoding (HD-SDI Input)
 - H.264 D1(720x480) Single Encoding(Analog Input, HD-SDI Input 720P)
 - H.264 Full HD, HD Dual Encoding(HD-SDI Input)
 - **H.264 Full HD, HD, D1 Triple Encoding (HD-SDI Input)**
 - H.264 Full HD, D1 Dual Encoding (HD-SDI Input)
 - H.264 HD, D1 Dual Encoding (HD-SDI Input)
- AV6000 Video Decoder Mode
 - H.264 Full HD
 - H.264 HD, Upscale to Full HD
 - H.264 D1, Upscale to Full HD

Video Codec Service Features

AV6000 Full HD Video Codec Module

AP-NC2000D Video Encoder

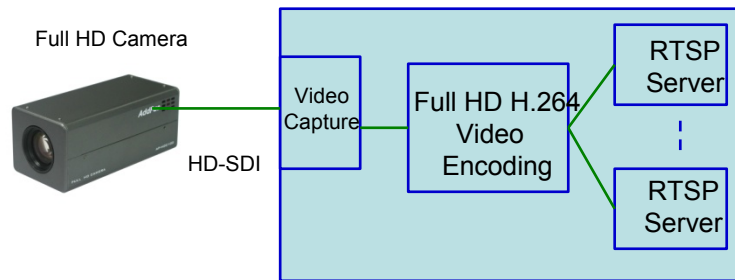

Single Full HD H.264 Video Encoding

AP-NC2000D Video Encoder

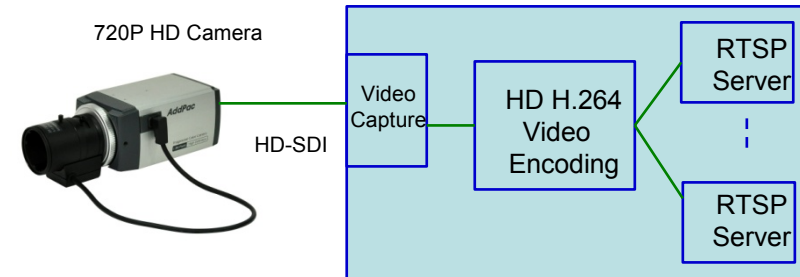

Single HD H.264 Video Encoding

AP-NC2000D Video Encoder

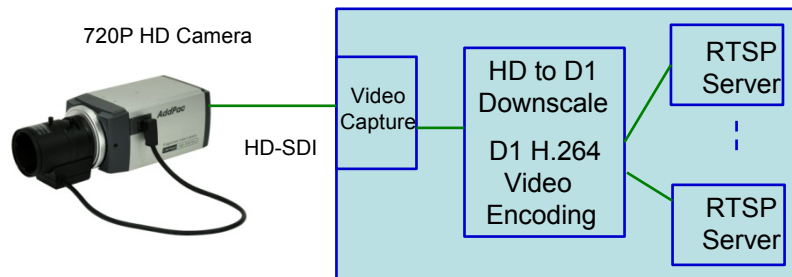

Single D1 H.264 Video Encoding

AP-NC2000D Video Encoder

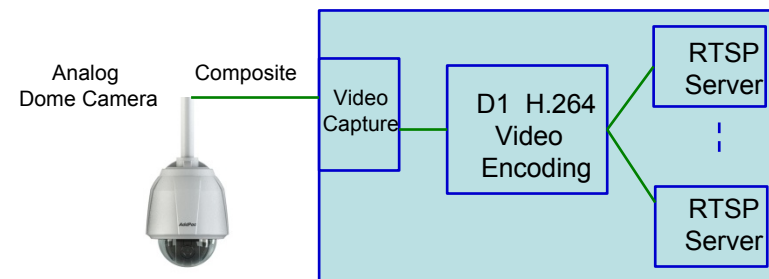

Single D1 H.264 Video Encoding

Video Codec Service Features

AV6000 Full HD Video Codec Module

AP-NC2000D Video Encoder

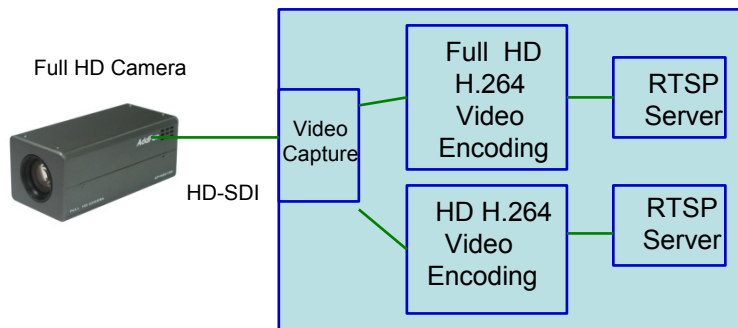

H.264 Full HD, HD Dual Video Encoding

AP-NC2000D Video Encoder

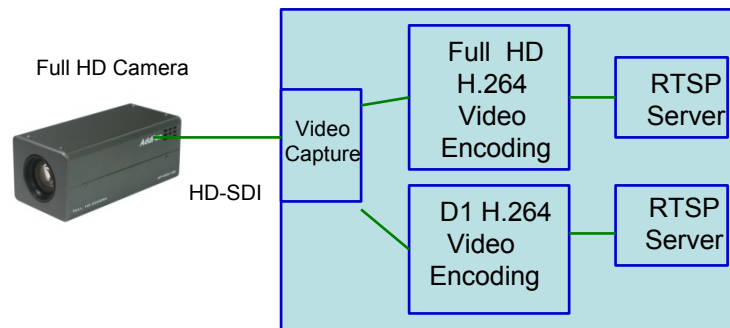

H.264 Full HD, D1 Dual Video Encoding

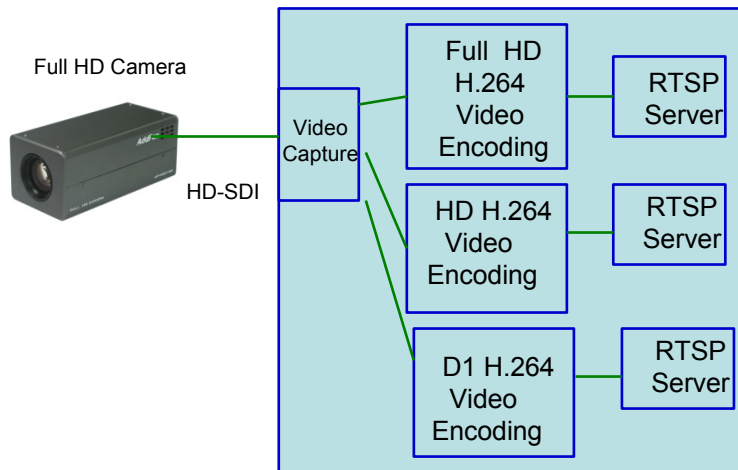

H.264 Full HD, HD, D1 Triple Video Encoding

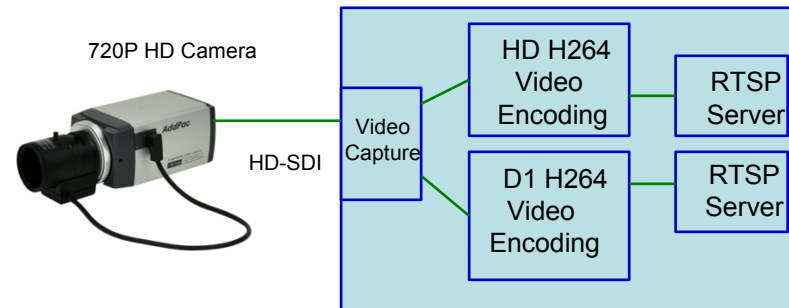

H.264 HD, D1 Dual Video Encoding

Network Service and Features

AV6000 Full HD Video Codec Module

Basic Network Protocols

- ARP, IPv4, TCP, UDP, ICMP, SCTP, IGMP, MLD

Routing Protocol

- IPv4 : Static

Service Protocol

- FTP, Telnet, TFTP, DHCP Server/Relay, SNMP Server
- CDP (Cisco Discovery Protocol)
- DNS Resolver , DDNS(nsupdate)
- Bridge
- Syslog

IPv4 Address Configuration

- Fixed (Static)
- DHCP
- PPPoE

Miscellaneous

- Standard & Extended IPv4 Access List
- Multi-level User Account Management
- IP accounting

Ordering Information

- **AV6000 Full HD Video Codec Module**
 - Main Chassis (Option) : AP-NC2000D, AP-NC2000, AP-NC3000, AP-NC5000
 - AP6000 Full HD Video Codec Module
 - Including Network Cable Set & Power Supply Cable, etc
- **Built-in APOS Internetworking Software for AV6000 Module**
- **Including 1 Year Hardware Warranty**
- **Product Documents**
 - Install and Operation Guide (PDF)
- **Pricing**
 - AddPac Technology Regional Sales Manager
 - Authorized Sales and Marketing Representatives
 - Please Contact www.addpac.com



Thank you!

AddPac Technology Co., Ltd.
Sales and Marketing

Phone +82.2.568.3848 (KOREA)

FAX +82.2.568.3847 (KOREA)

E-mail sales@addpac.com