

# IP Video Door Phone Solution Application Note (Cisco Call Manager Interworking : GCF(Green Climate Fund))



AP-VAC50



AP-VP280



AP-ACS1000  
(Door Access Control Server)



**AddPac**

**AddPac Technology**

Sales and Marketing

# Contents

- Cisco Call Manager Interworking Network Diagram
- IP Video Door Phone Solution Components
  - AP-VAC50 IP Video Door Phone
  - AP-ACS100 Door Access Control Server & Web based Video Access Control Client(User registration, etc)
  - Smart Video Controller : Video Only Door Control S/W for Desktop
  - AP-VP280 Video Phone

# IP Video Door Phone Application

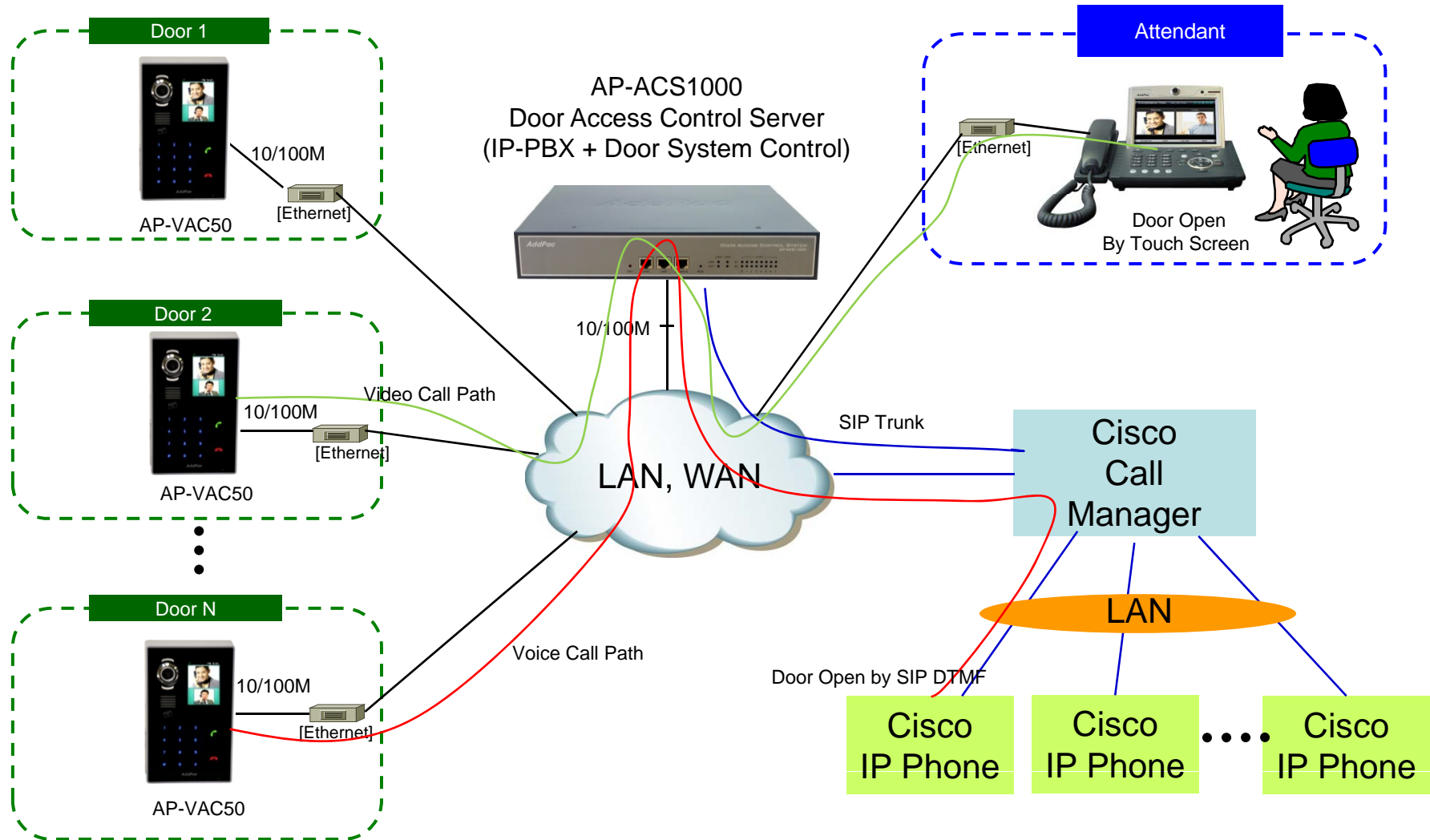





# IP Video Door Phone Solution Components



# AP-VAC50 IP Video Door Phone

# Main Features

## AP-VAC50 IP Video Door Phone

- High Performance IP Video Door Phone Solution
- Video Camera, 3x4 Key, TFT Color LCD, Internal MIC & Speaker
- H.323/SIP Concurrent VoIP Signaling Stack Embedded
- RF Card Interface
- High-performance Video/Voice Codec Support
  - H.264/MPEG4, G.711, etc
- One(1) 10/100Mbps Fast Ethernet
- PoE(Power over Ethernet) Support
- High Quality Speaker Phone Features
- Powerful Acoustic Echo Canceller
- Powerful Network Protocols (PPPoE, DHCP, Static Routing, etc)
- Firmware Upgradeable Architecture
- Advanced Voice QoS Mechanism



# Hardware Specification

## AP-VAC50 IP Video Door Phone

RISC  
CPU

High-end  
DSP

- RISC+DSP Microprocessor Computing Power (Dual Processor Architecture)
- Audio and Voice Interface
  - Internal MIC
  - Internal Speaker
  - 3 x 4 key PAD
- Video Camera Interface
- 2 Inch TFT Color LCD Interface
- RF Card Interface
- Network Interface
  - One(1) 10/100Mbps Fast Ethernet
- Alarm & Relay Out Interface (door open, etc)
- RS232/RS422/RS485 Interface
- Power Supply
  - Power over Ethernet (Option)
  - External Power Supply

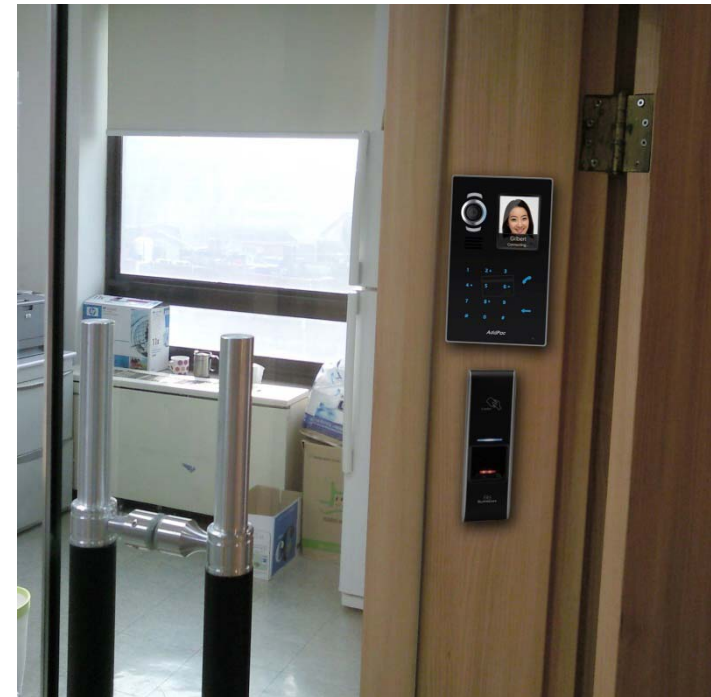



# Hardware Specification

AP-VAC50 IP Video Door Phone

RISC  
CPU

High-end  
DSP

## Front Side

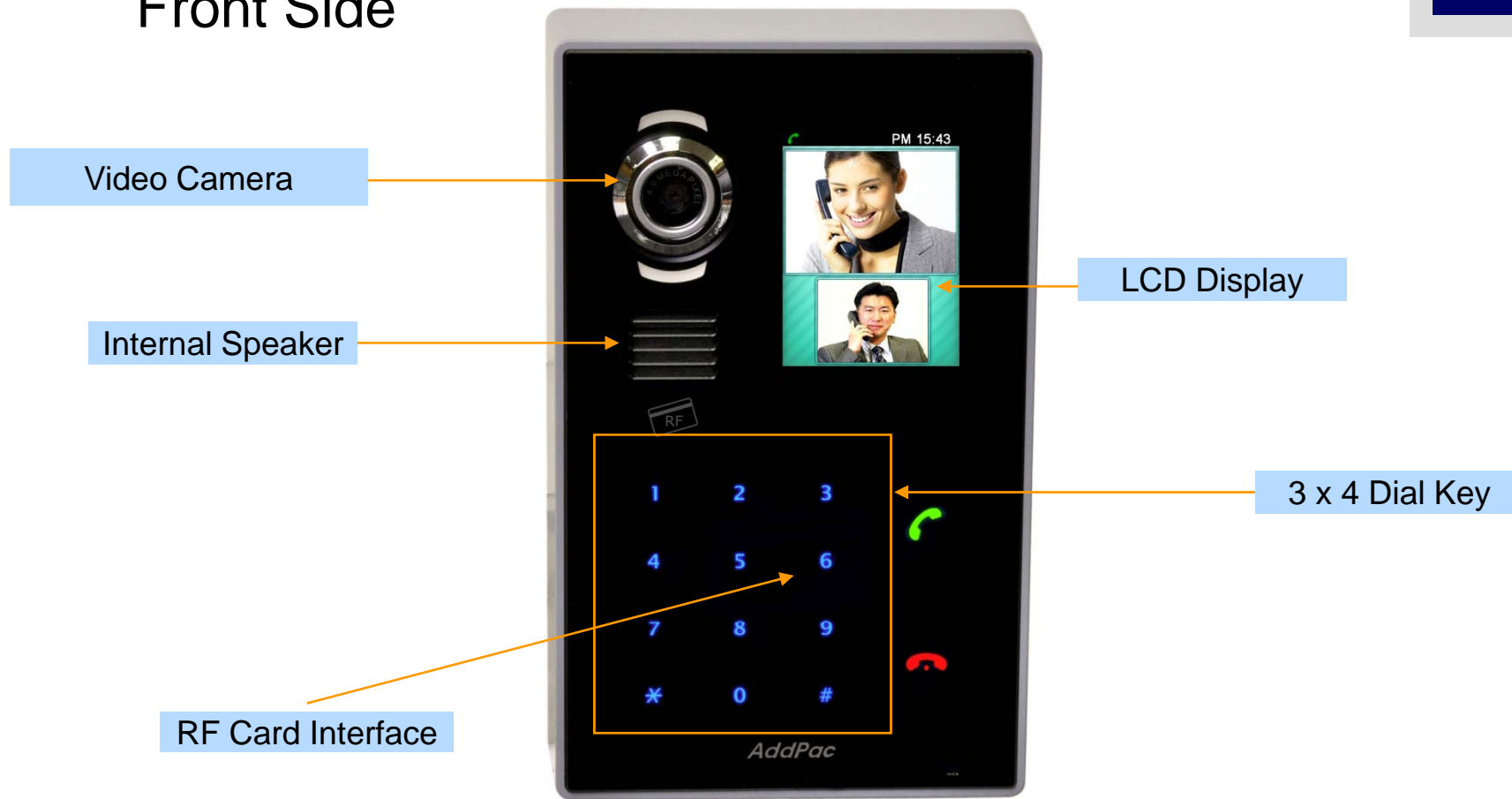

**AddPac**

[www.addpac.com](http://www.addpac.com)

Internal MIC Input



# AP-ACS1000 Door Access Control Server

# Contents

- DACS(Door Access Control Server) Network Diagram
- AP-ACS1000 DACS Main Features
- AP-ACS1000 DACS Hardware Specification
- DACS System Message Flow (Examples)
- DACM (Door Access Control Manager)
- Open API for Third Party Controller

# Integrated Door Access Control and Call Control

## AP-ACS1000 DACS (Door Access Control Server)

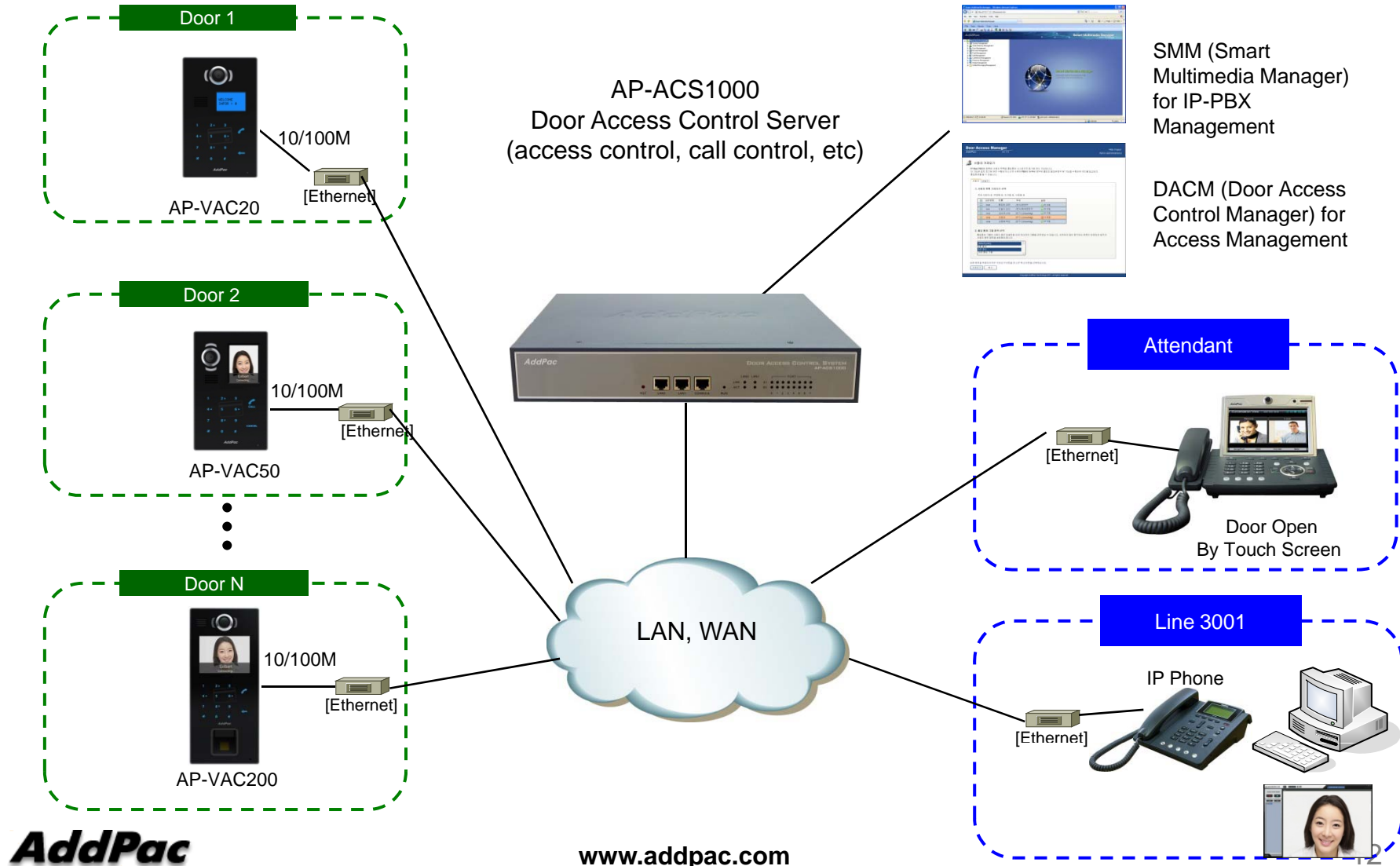



# AP-ACS1000 Door Access Control Server

# Main Features

## AP-ACS1000 DACS (Door Access Control System)

- Door Access Control Application System
- SIP Application Server, Proxy, Registrar and Location Server
- Multiple ITSP Trunk with SIP & H.323 Accounts Support
- Legacy PBX Interworking Service
- High Performance RISC & Programmable DSP Architecture
- Two(2) 10/100Mbps Fast Ethernet (IP Share ,etc)
- High Performance LAN-to-LAN Routing Capability
- Powerful Network Protocols (PPPoE, DHCP, Static Routing, etc)
- IPv4/IPv6 Dual Stack
- Firmware Upgradeable Architecture
- Smart Multimedia Manager for IP-PBX Management
- DACM(Door Access Control Manager)
- Advanced Voice QoS Mechanism
- Small, Light and Compact Design
- Two(2) VoIP Module Slots for Analog, Digital Interface

# Main Features

## AP-ACS1000 DACS (Door Access Control System)

- RISC Microprocessor Computing Power
- Main Chassis
  - Network Interface
    - Two(2) 10/100Mbps Fast Ethernet
    - One(1) RS-232C Console (RJ45)
  - Two(2) VoIP Module Slots for FXS, FXO etc



# Hardware Specification

## AP-ACS1000 DACS (Door Access Control System)

### AP-ACS1000 Back Side

PSTN Interface Module

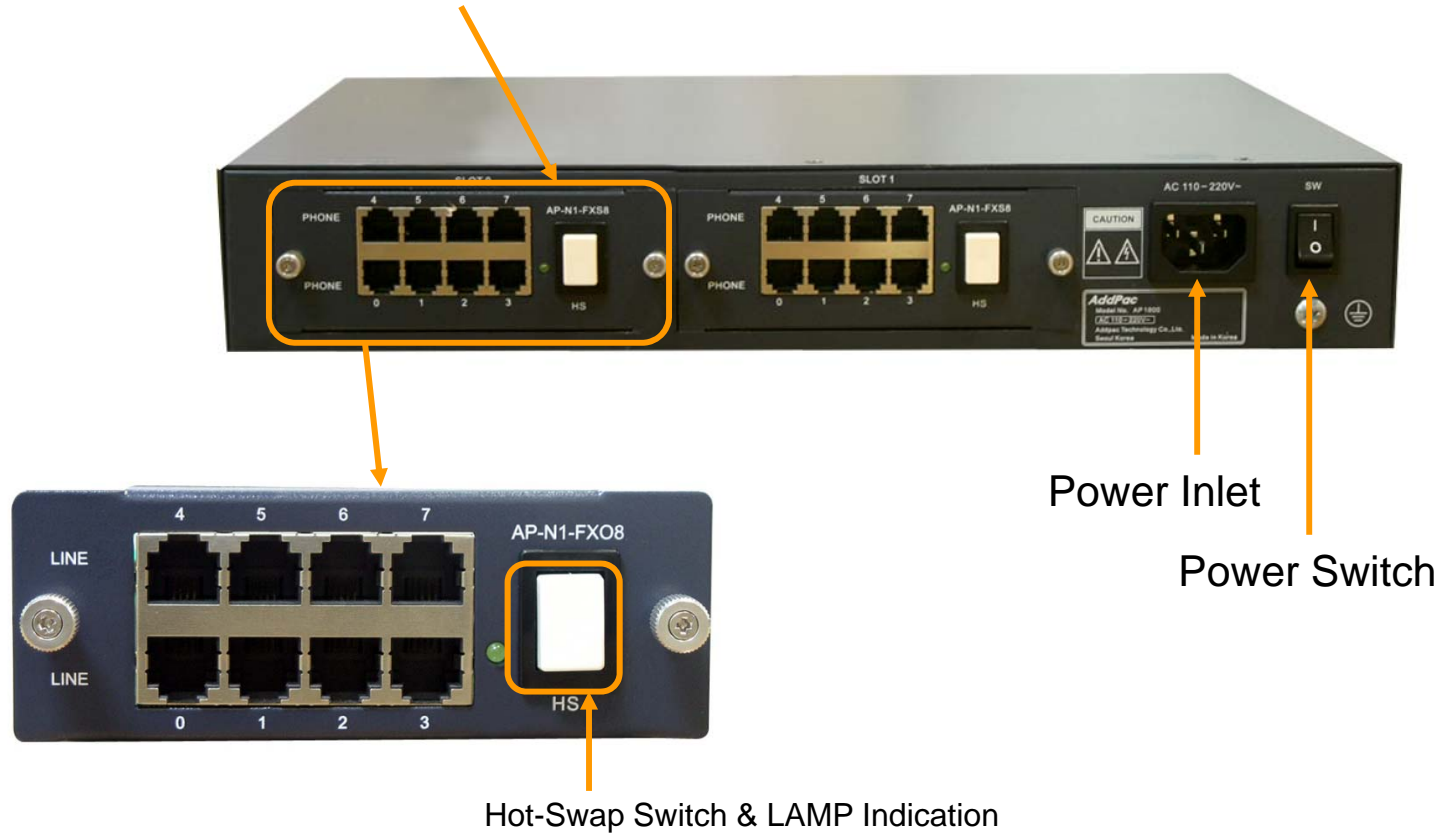







# Hardware Specification

AP-ACS1000 DACS (Door Access Control System)

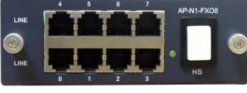
## PSTN Interface Module

<b>AP-N1-FXS8</b>	 A black 8-port FXS voice processing module with RJ11 ports numbered 0-7 and a central switch labeled 'HS'.	8-Port FXS Voice Processing Module (8 x RJ11)
<b>AP-N1-FXO8</b>	 A black 8-port FXO voice processing module with RJ11 ports numbered 0-7 and a central switch labeled 'HS'.	8-Port FXO Voice Processing Module (8 x RJ11)
<b>AP-N1-FXO4S4</b>	 A black module with 4 FXO and 4 FXS ports, each with RJ11 connectors, and a central switch labeled 'HS'.	4-Port FXO and 4-Port FXS Voice Processing Module (8 x RJ11)
<b>AP-N1-E1T1</b>	 A black module with a green PCB, a single RJ45 port labeled 'E1/T1', and status LEDs for 'ACT' and 'LOS'.	1-Port VoIP Digital E1/T1 Interface Module(1xRJ45)



# DACS System Message Flow

# DACS System Message Flow

## Registration and KeepAlive

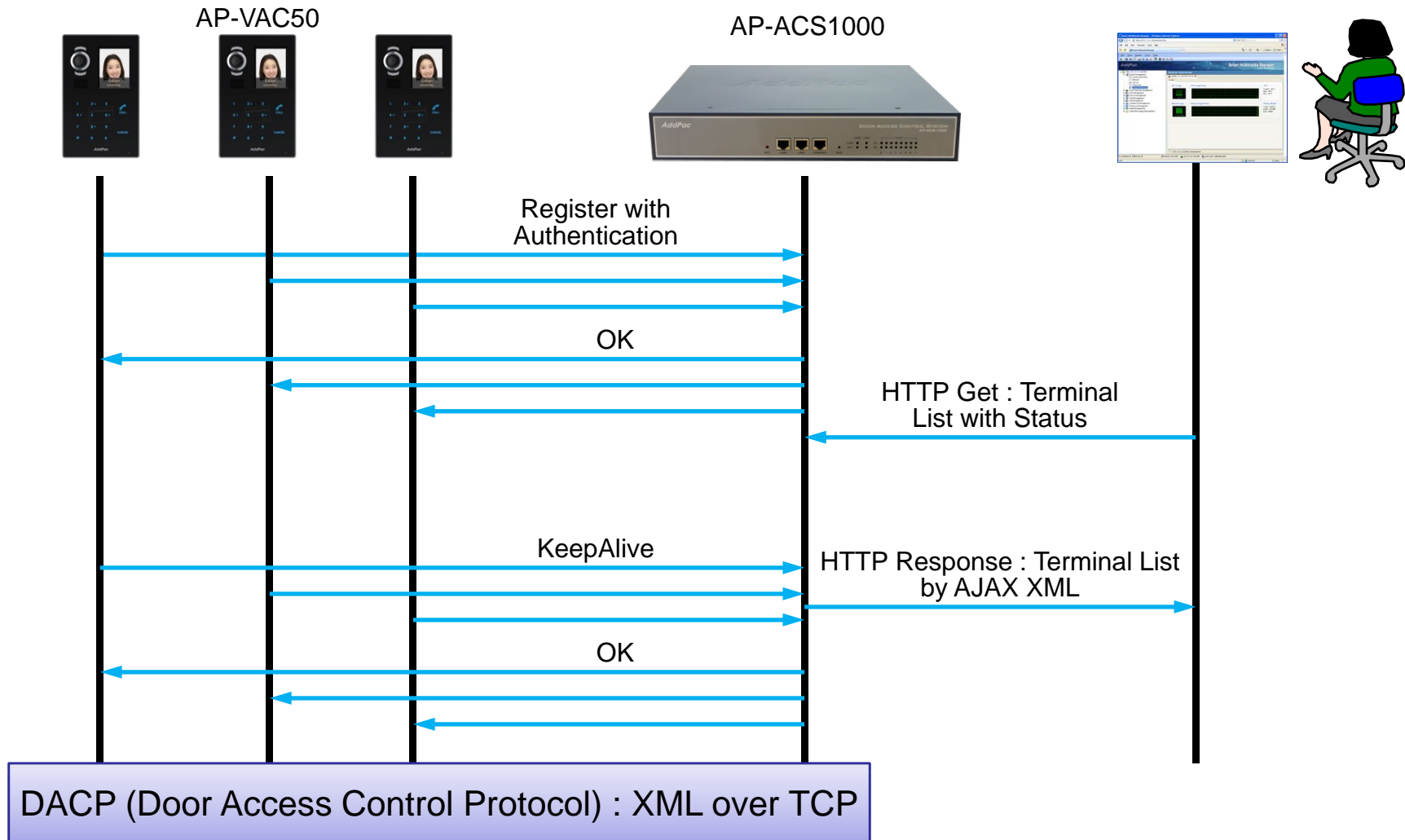

# DACS System Message Flow

## Access Privilege and Schedule Download

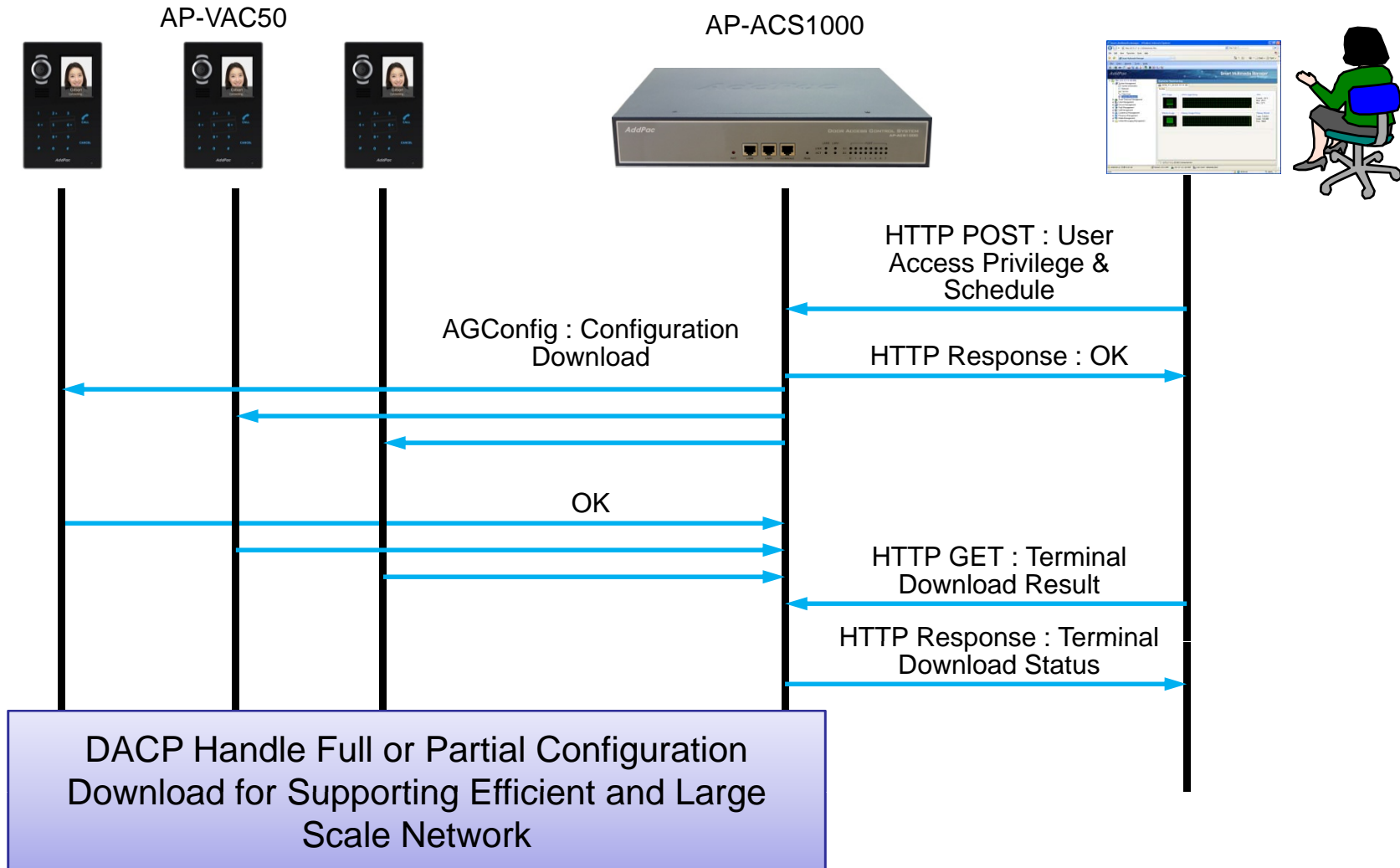

# DACS System Message Flow

## RF Card Read/Write and Registration

AP-VAC50



AP-ACS1000

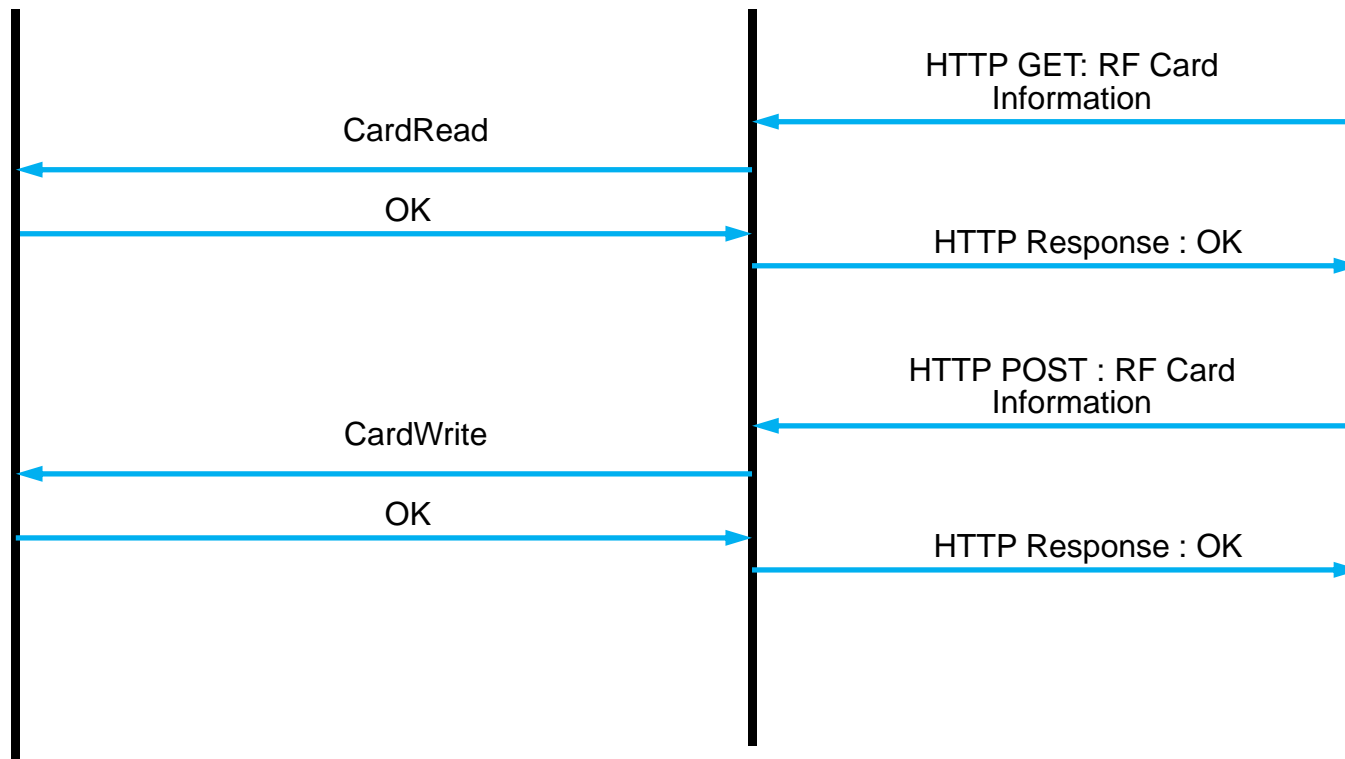
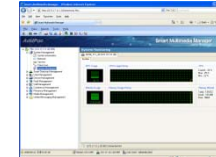

# DACS System Message Flow

## Door Open by RF Card or Password

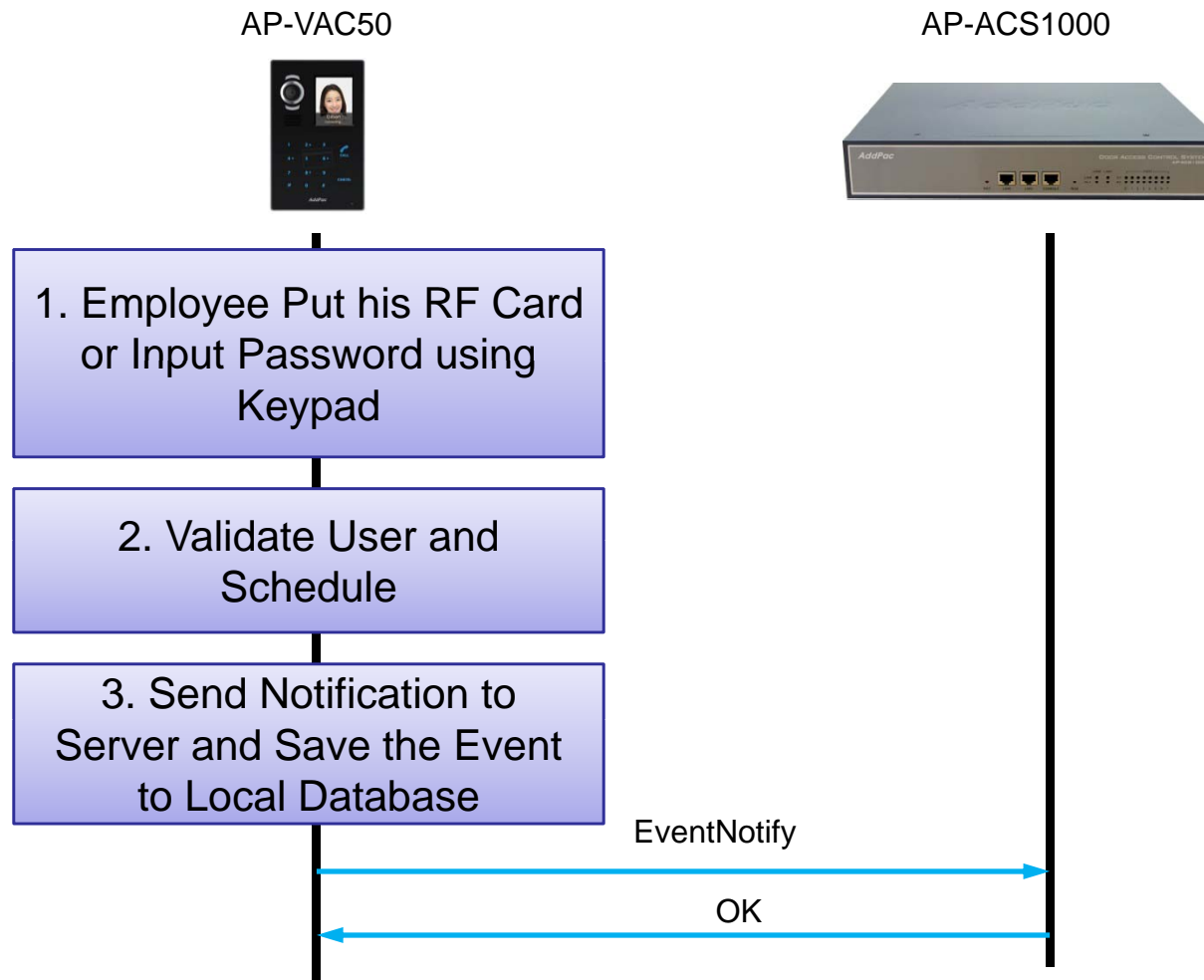

# DACS System Message Flow

## Door Open by Other Terminal

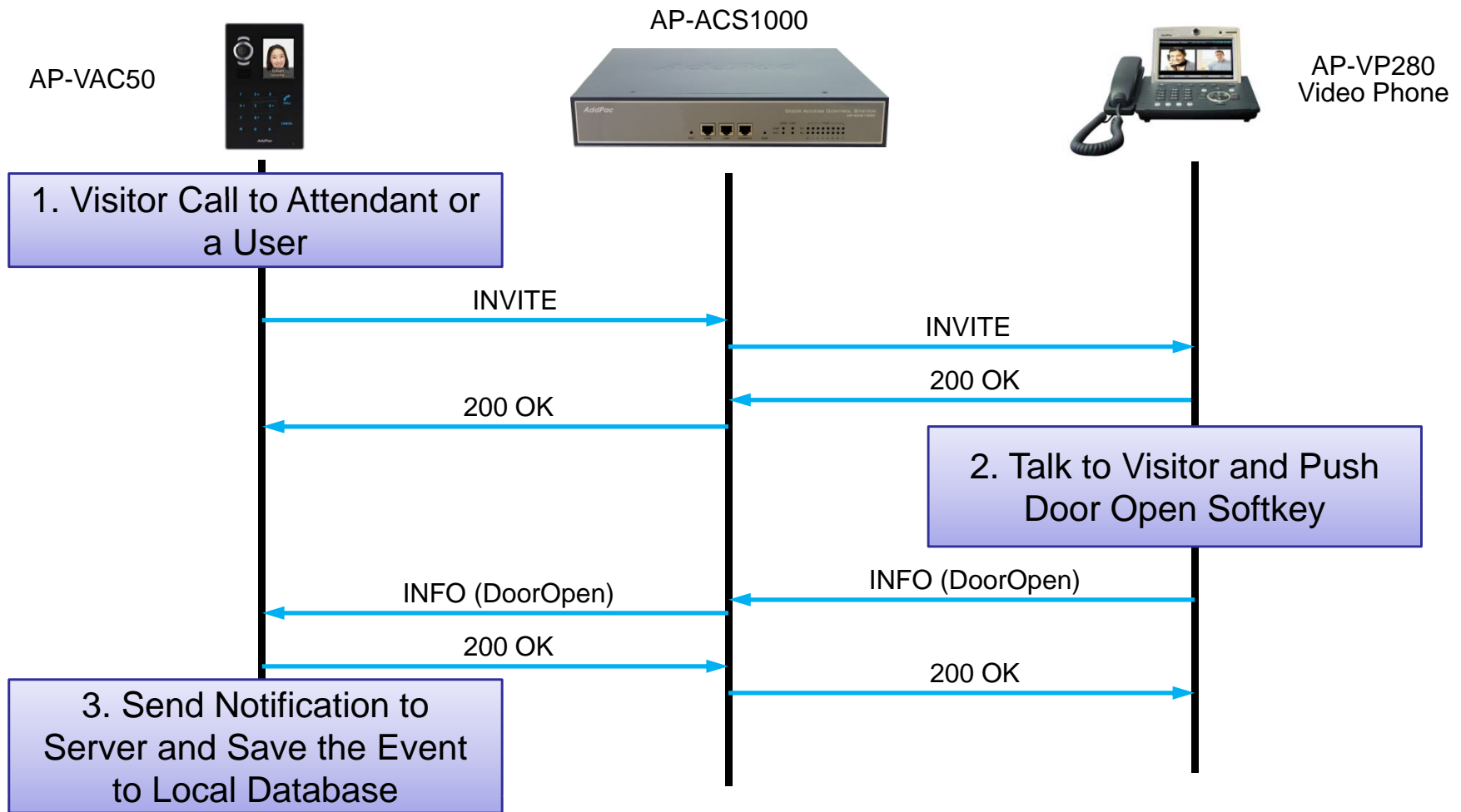



# Door Access Control Manager for AP-ACS1000



# DACM (Door Access Control Manager)

## Main Web Page

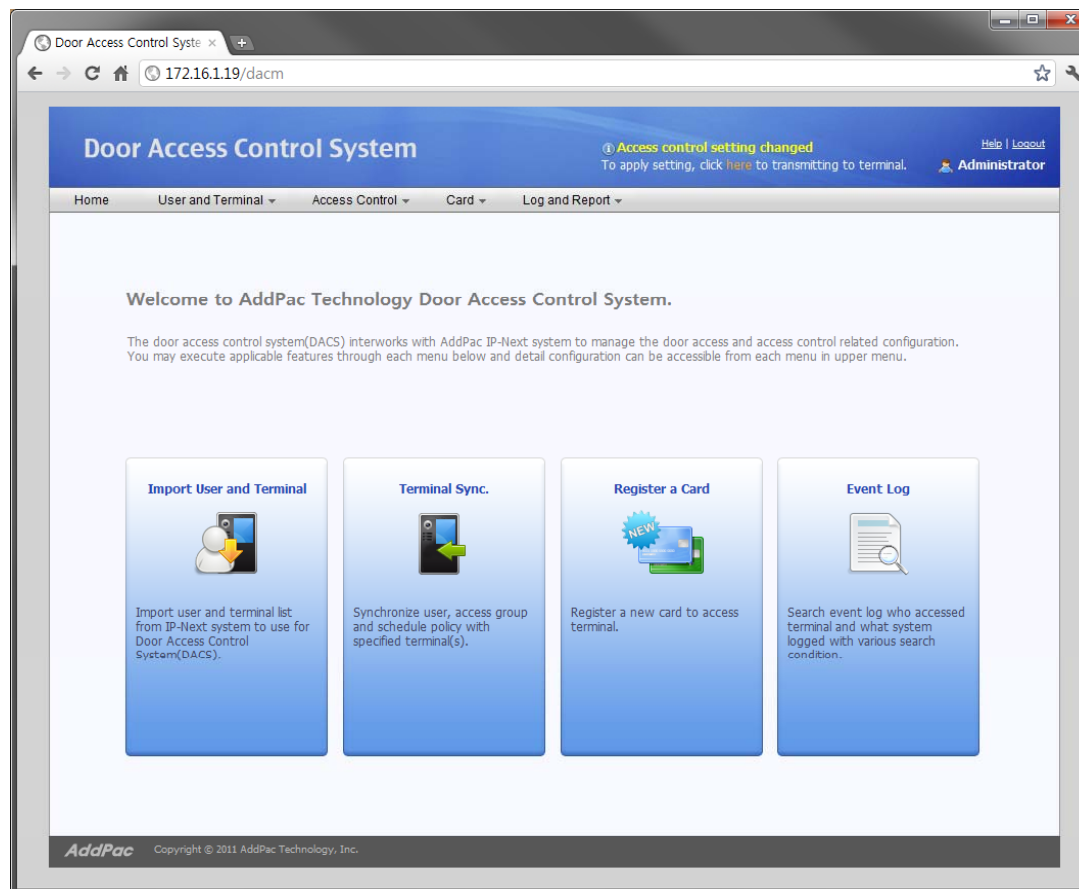

# DACM (Door Access Control Manager)

## Import User and Terminal

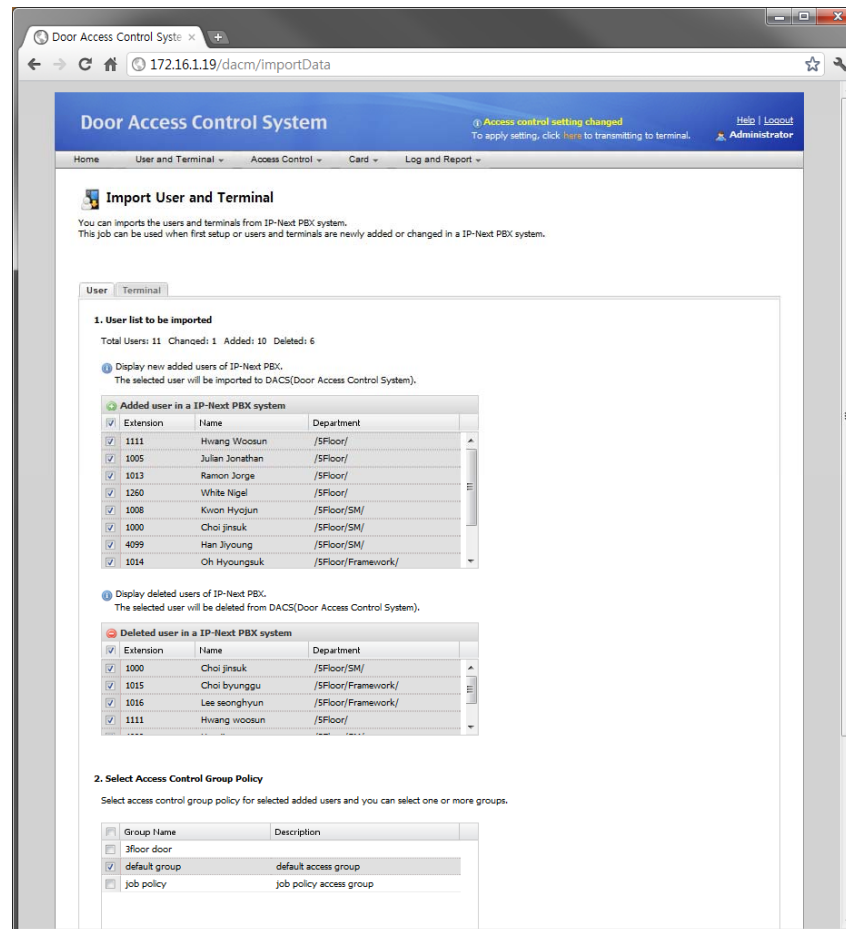

# DACM (Door Access Control Manager)

## User List

Door Access Control System

Access control setting changed  
To apply setting, click [here](#) to transmitting to terminal.

Help | Logout  
Administrator

Home User and Terminal Access Control Card Log and Report

### User List

Search registered access terminal user or search for all users. You can proceed add/change/delete through the screen.

Search List: All Users Input search word Search Import User

	Extension	Name	Department	Access Policy	Date Created	Modify	Delete
1	1000	Choi jinsuk	/SFloor/SM/	Access Allow	2011-07-22 15:50:01		
2	1008	Kwon hyojun	/SFloor/SM/	Access Allow	2011-07-22 15:50:00		
3	1014	Oh hyongsuk	/SFloor/Framework/	Access Allow	2011-07-22 15:50:01		
4	1015	Choi byunggu	/SFloor/Framework/	Access Allow	2011-07-22 15:50:01		
5	1016	Lee seonghyun	/SFloor/Framework/	Access Allow	2011-07-22 15:50:01		

Page 1 of 1 Total: 5

AddPac Copyright © 2011 AddPac Technology, Inc.

# DACM (Door Access Control Manager)

## Terminal List

Door Access Control System

Access control setting changed  
To apply setting, click [here](#) to transmitting to terminal.

Help | Logout  
Administrator

Home User and Terminal Access Control Card Log and Report

### Terminal List

Display the registered door phone lists imported from IP-Next PBX system.

Import Terminal

	Terminal Name	Description	Status	Extension	IP Address	Model Name	Version	Date Created	Detail View
1	2floor door terminal	2Floor door ter...	Connected	1006	172.16.10.4	AP-VAC50		2011-07-29 17:08:50	
2	3floor door terminal	3Floor door ter...	Connected	1002	172.16.10.1	AP-VAC20	8.50.001	2011-07-22 15:50:01	
3	5floor door terminal	5Floor door ter...	Connected	1005	172.16.10.2	AP-VAC50		2011-07-29 17:08:50	
4	The main entrance d...	The main entran...	Connected	Required setting	172.16.10.3	AP-VAC100		2011-07-29 17:08:50	

Page 1 of 1 Total: 4

AddPac Copyright © 2011 AddPac Technology, Inc.

# DACM (Door Access Control Manager)

## Access Control Group Management

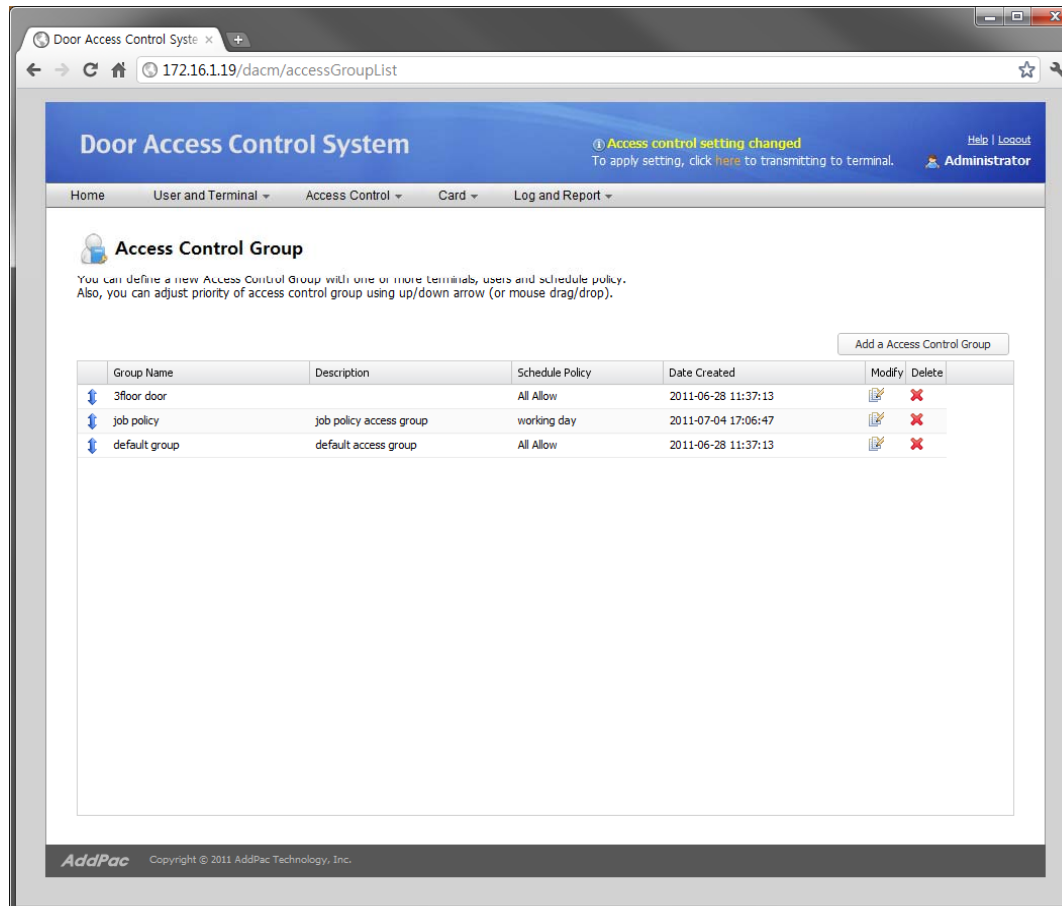

The screenshot displays the 'Door Access Control System' web interface. The browser address bar shows '172.16.1.19/dacm/accessGroupList'. The page title is 'Door Access Control System'. A notification banner indicates 'Access control setting changed' with instructions to apply settings. The user is logged in as 'Administrator'. The main content area is titled 'Access Control Group' and includes a brief description: 'You can define a new Access Control Group with one or more terminals, users and schedule policy. Also, you can adjust priority of access control group using up/down arrow (or mouse drag/drop)'. A table lists existing groups, and a button 'Add a Access Control Group' is visible.

Group Name	Description	Schedule Policy	Date Created	Modify	Delete
3floor door		All Allow	2011-06-28 11:37:13		
job policy	job policy access group	working day	2011-07-04 17:06:47		
default group	default access group	All Allow	2011-06-28 11:37:13		

# DACM (Door Access Control Manager)

## Configuration Download to Terminal

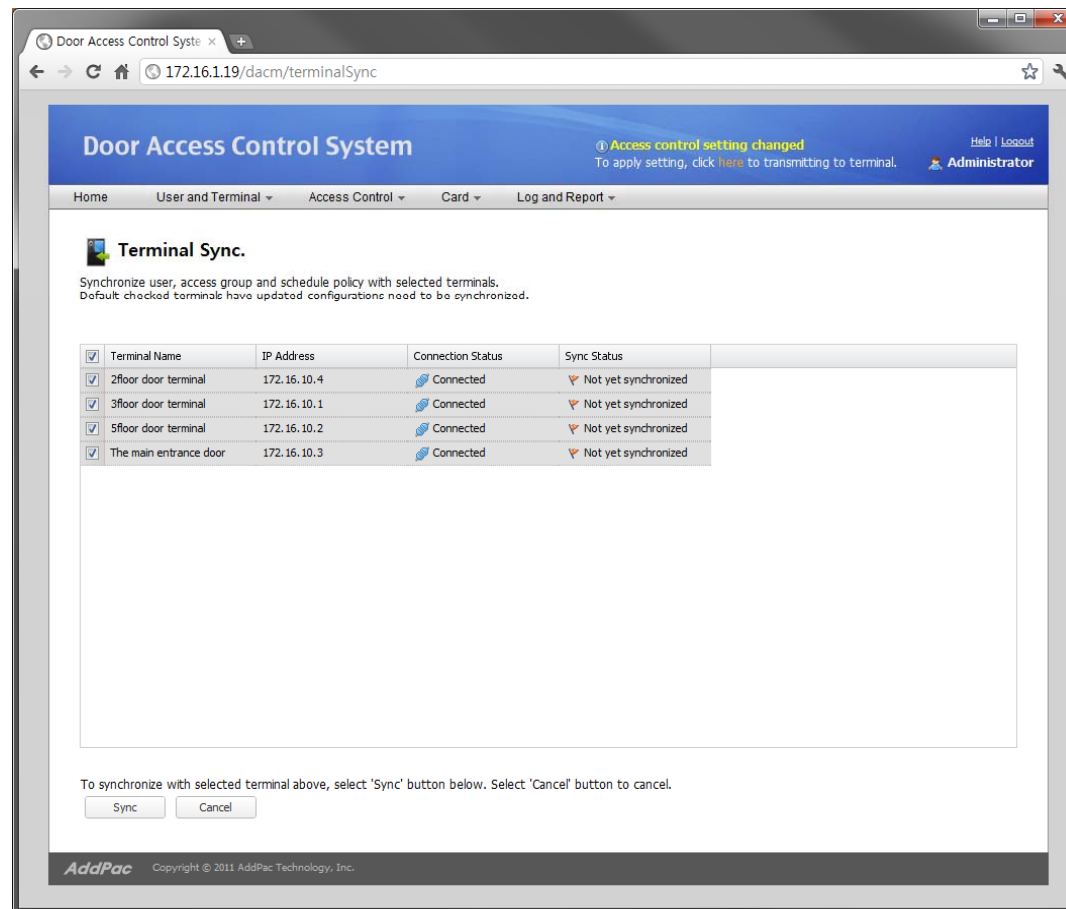

Door Access Control System

Access control setting changed  
To apply setting, click [here](#) to transmitting to terminal.

Help | Logout  
Administrator

Home User and Terminal Access Control Card Log and Report

### Terminal Sync.

Synchronize user, access group and schedule policy with selected terminals.  
Default checked terminals have updated configurations need to be synchronized.

<input checked="" type="checkbox"/>	Terminal Name	IP Address	Connection Status	Sync Status
<input checked="" type="checkbox"/>	2floor door terminal	172.16.10.4	Connected	Not yet synchronized
<input checked="" type="checkbox"/>	3floor door terminal	172.16.10.1	Connected	Not yet synchronized
<input checked="" type="checkbox"/>	5floor door terminal	172.16.10.2	Connected	Not yet synchronized
<input checked="" type="checkbox"/>	The main entrance door	172.16.10.3	Connected	Not yet synchronized

To synchronize with selected terminal above, select 'Sync' button below. Select 'Cancel' button to cancel.

AddPac Copyright © 2011 AddPac Technology, Inc.

# DACM (Door Access Control Manager)

## RF Card Management

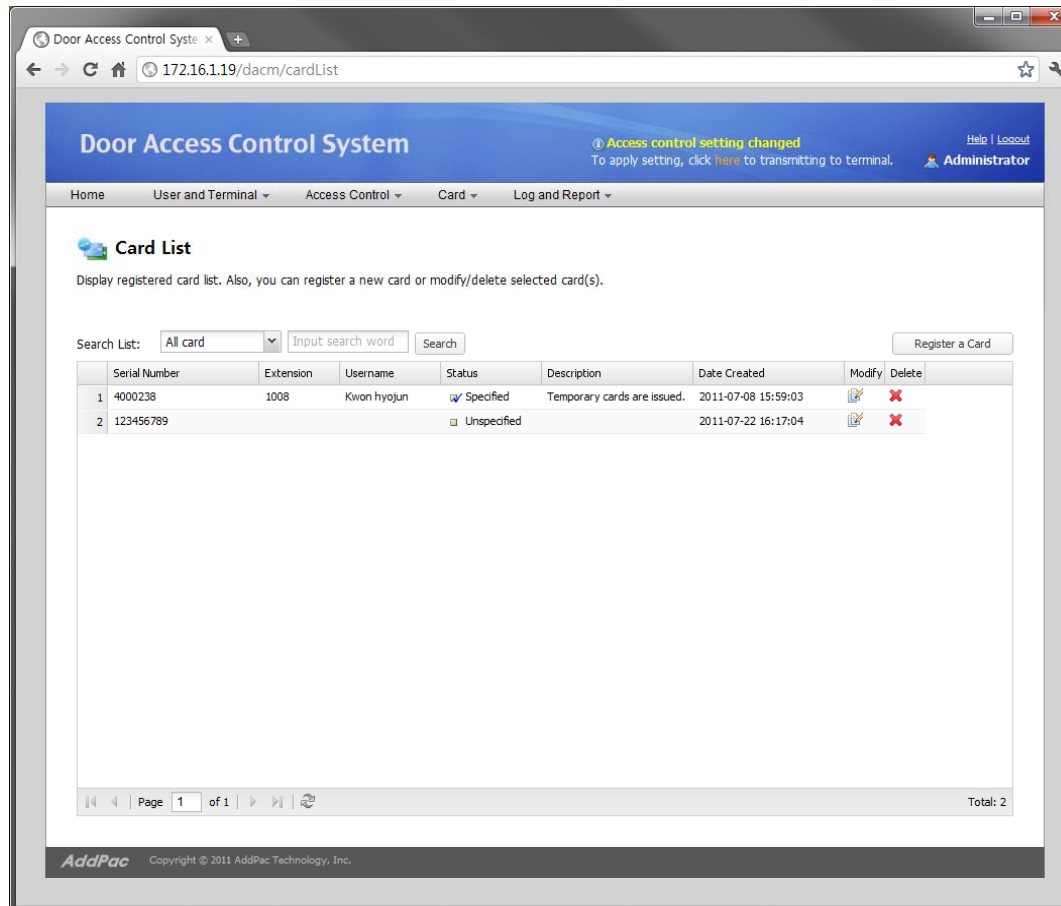

The screenshot displays the 'Door Access Control System' web interface. The browser address bar shows '172.16.1.19/dacm/cardList'. The page title is 'Door Access Control System'. A notification banner indicates 'Access control setting changed' with instructions to click a link to transmit settings to the terminal. The user is logged in as 'Administrator'. The main content area is titled 'Card List' and includes a search filter set to 'All card' and a search input field. A table lists two registered cards:

Serial Number	Extension	Username	Status	Description	Date Created	Modify	Delete
1 4000238	1008	Kwon hyojun	<input checked="" type="checkbox"/> Specified	Temporary cards are issued.	2011-07-08 15:59:03		
2 123456789			<input type="checkbox"/> Unspecified		2011-07-22 16:17:04		

At the bottom of the page, there is a pagination control showing 'Page 1 of 1' and a 'Total: 2' indicator. The footer contains the 'AddPac' logo and copyright information: 'Copyright © 2011 AddPac Technology, Inc.'

# DACM (Door Access Control Manager)

## Access Log Management

The screenshot shows a web browser window displaying the 'Door Access Control System' interface. The page title is 'Door Access Control System' and the URL is '172.16.1.19/dacm/eventLog'. The user is logged in as 'Administrator'. A notification banner at the top right states 'Access control setting changed' with a link to 'Apply setting, click here to transmitting to terminal.' The main content area is titled 'Event Log' and includes a search filter section with fields for 'Duration' (11-07-10 to 11-08-09), 'User Extension Number', and 'Event Level' (set to 'Error'). Below the search filters is a table of event logs with columns for 'Time', 'Level', 'User Extension', and 'Event'. The table contains 7 entries. At the bottom of the page, there is a pagination control showing 'Page 1 of 1' and a 'Total: 7' indicator. The footer of the page includes the 'AddPac' logo and 'Copyright © 2011 AddPac Technology, Inc.'

	Time	Level	User Extension	Event
1	2011-07-15 10:27:27	Warning	1000	authentication failure
2	2011-07-15 11:25:27	Notice	1000	registration success
3	2011-07-15 12:21:27	Notice	1200	registration success
4	2011-07-16 09:27:27	Information	1201	door opened
5	2011-07-16 11:27:27	Information	1007	registration success
6	2011-07-16 17:12:00	Notice		security profile downloading completed
7	2011-07-17 18:00:00	Notice		system started





# AP-ACS1000 Open API

# Open API

## Open API for 3'rd Party Management System

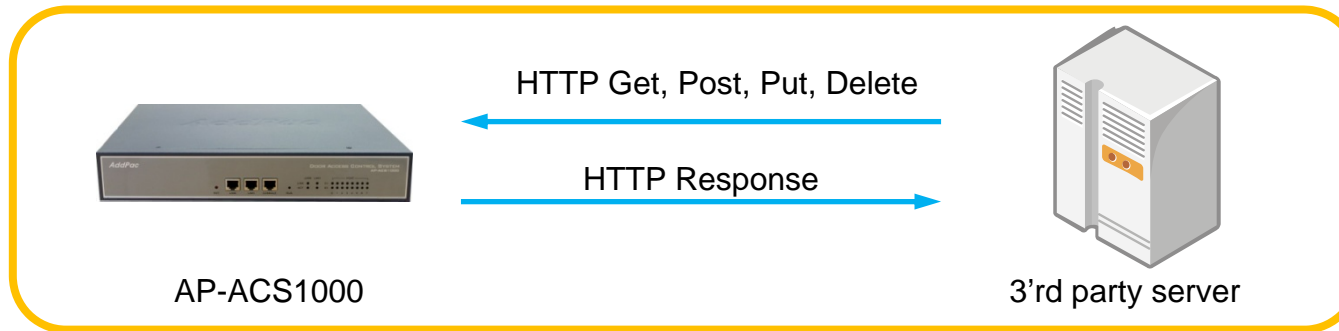

- HTTP based RESTful Open API for Door Access Management
- XML based Flexible and Expandable Message Contents
- Provides More than 40 APIs as Bellow
  - user\_list(GET), user(GET, POST, PUT, DELETE), ...
  - terminal\_list(GET), terminal(GET, POST, PUT, DELETE), ...
  - access\_group(GET, POST, PUT, DELETE), priority (PUT), ...
  - card\_list(GET), card(POST, PUT, DELETE), ...
  - schedule\_template(GET, POST, PUT, DELETE), rule(GET, POST, PUT, DELETE) ,...



# Smart Video Controller : Automatic Video PopUp Service in Desktop PC

# Contents

- Overview
- Smart Video Controller Service Diagram
- Smart Video Controller Configuration
  - Configuration
  - Program Setup
- Smart Video Controller Service
  - VAC50 to IP Phone with VLC
  - VAC50 to Analog Phone with VLC
- Smart Video Controller Service Scenario

# Overview

- Smart Video Controller Features
  - MS Window based Program : XP, Vista, Window7 support
  - Voice : IP Phone or Analog Phone(Legacy PBX)
  - Video: MS Window Program, PC based Video Decoder & Displayer
  - RTSP(Real Time Streaming Protocol) Protocol Support
  - Video Communication Service for general analog phone, IP phone user
    - I. VAC50 to IP Phone with VLC Player
    - II. VAC50 to Analog Phone with VLC Player



# Smart Video Controller Service Diagram

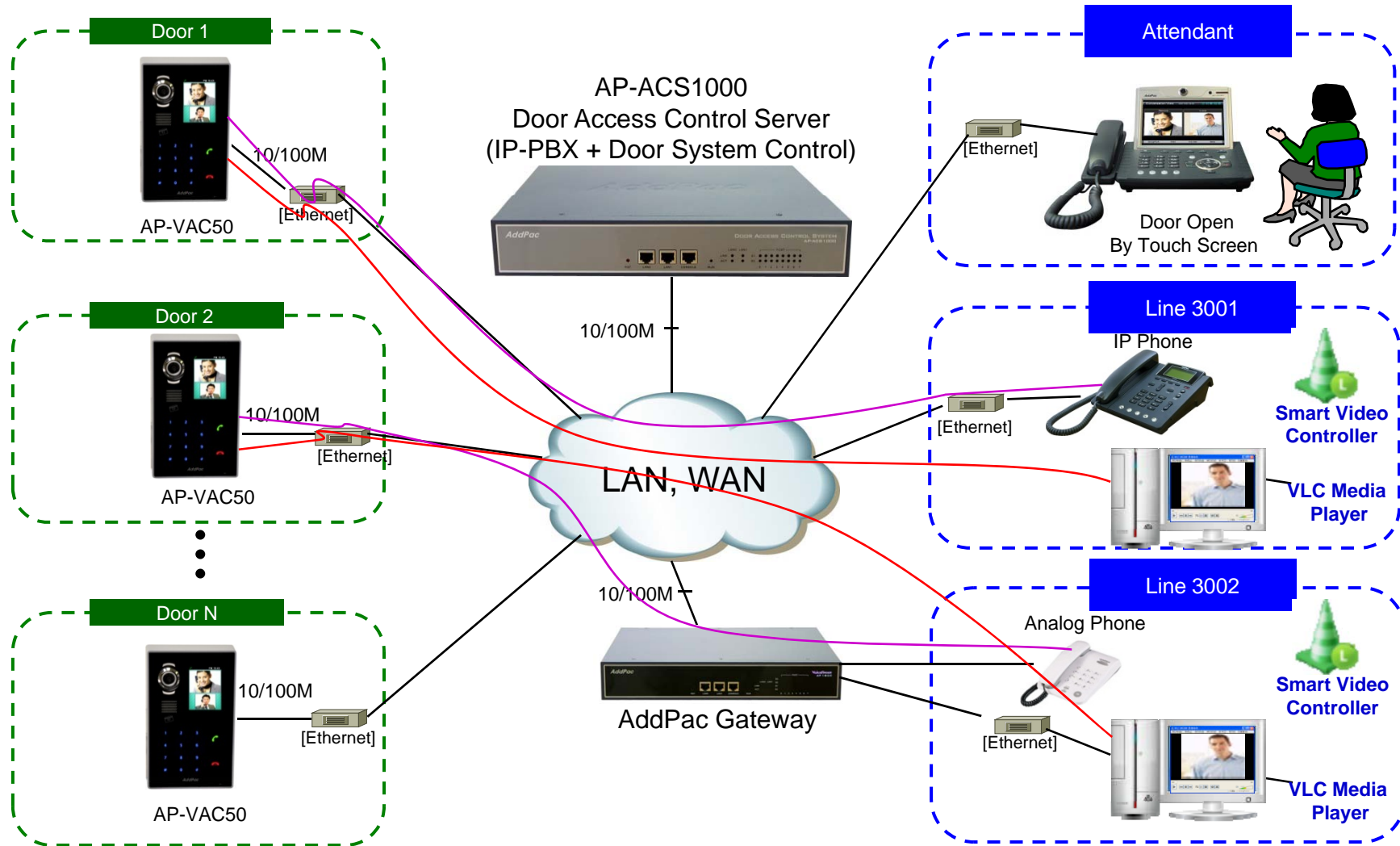

# Smart Video Controller Configuration

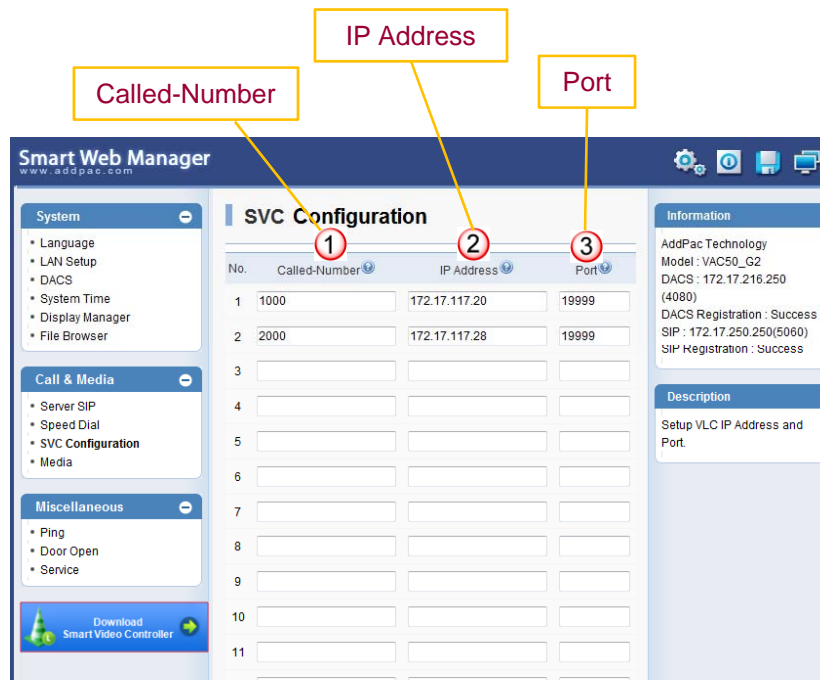

[Figure 1]  
AP-VAC50 Smart Web

- 1 Internal extension (line) number for voice only terminal such as analog phone, IP Phone, etc.
- 2 Personal Computer's IP Address
- 3 Port Number (Default .19999)

# Smart Video Controller Configuration (Cont.)

## Smart Video Controller Program Setup

VLC Media Player Program must be pre-installed before Smart Video Controller program setup procedure.

(VLC Player is MS window software that support RTSP based Video Decoder & Display service

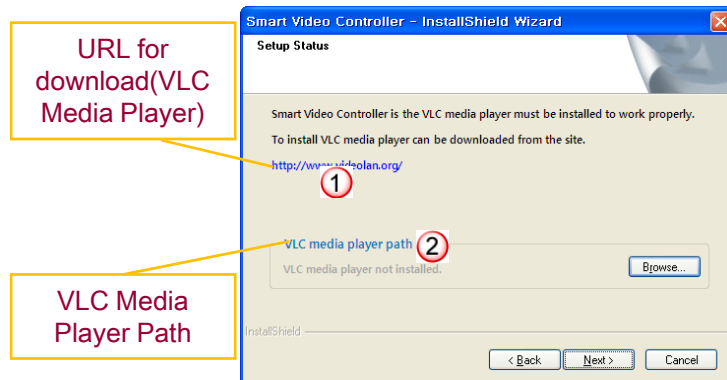

[Figure 1]  
VLC Media Player Install Shield

- ① VLC Program Download URL Address
- ② VLC Program Execution File Path

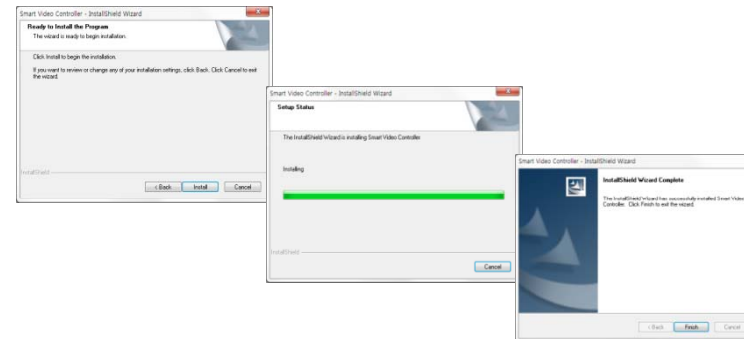

[Figure 2]  
Smart Video Controller Install Progress

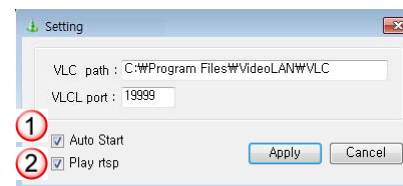

[Figure 3]  
Smart Video Controller Setting

- ① Program Auto Start at PC booting time
- ② Program enable/disable



# Smart Video Controller Service

: VAC50 to IP Phone with VLC

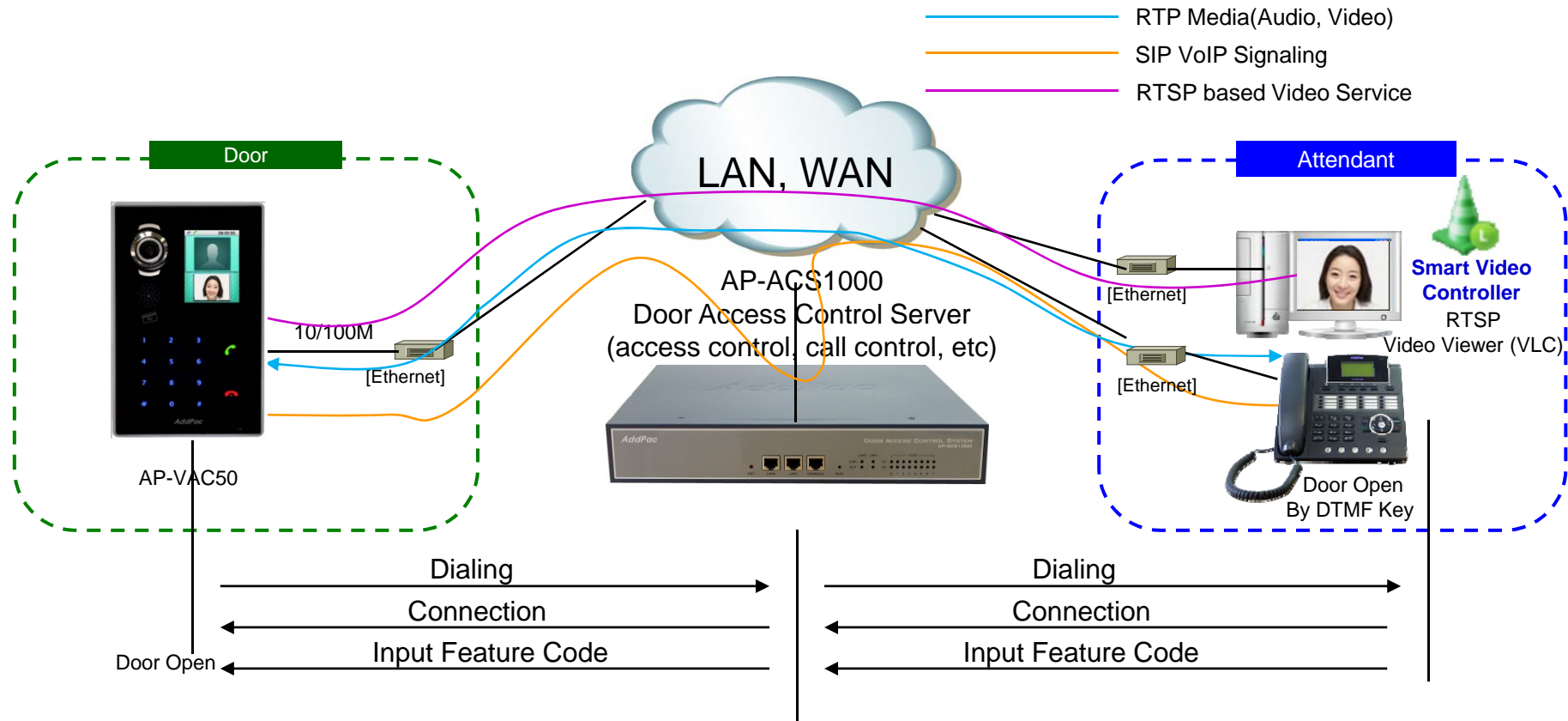

# Smart Video Controller Service(Cont.)

## : VAC50 to Analog Phone with VLC

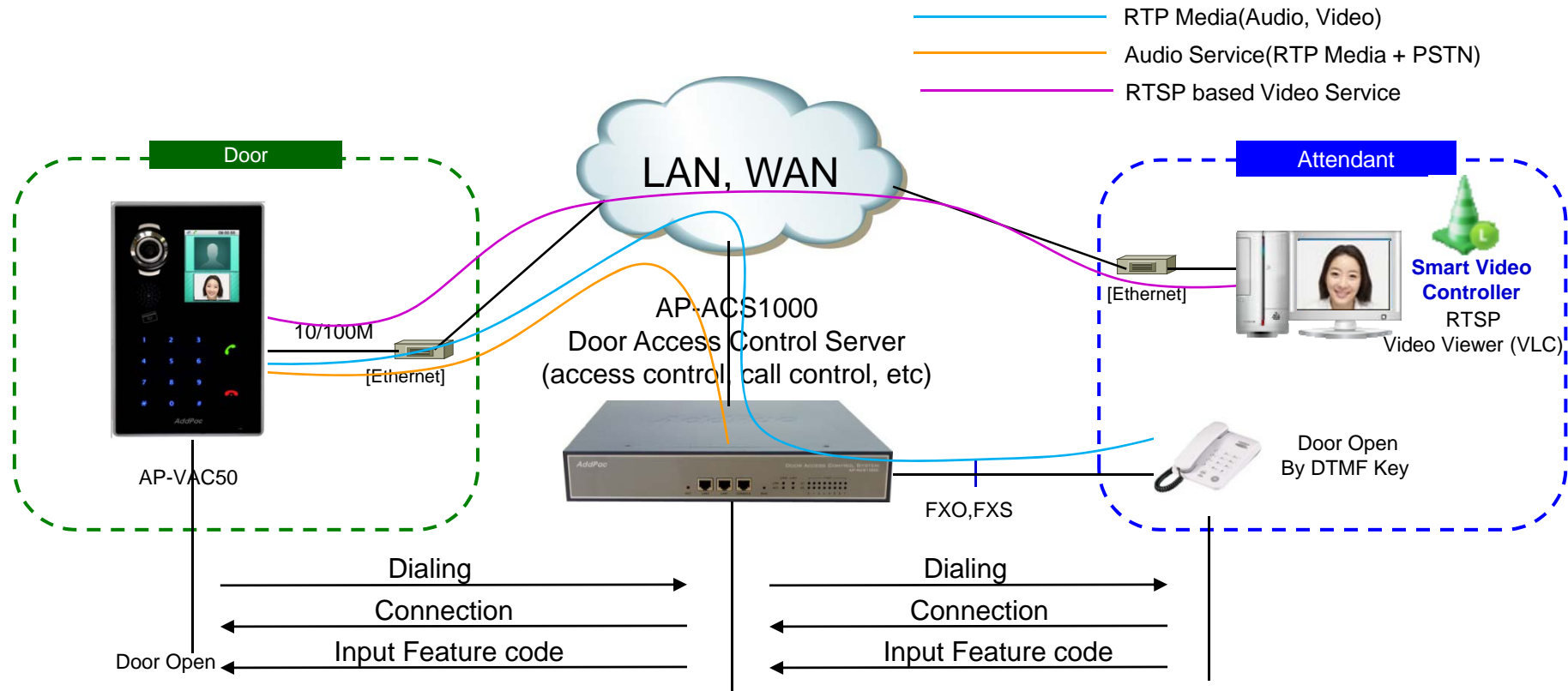



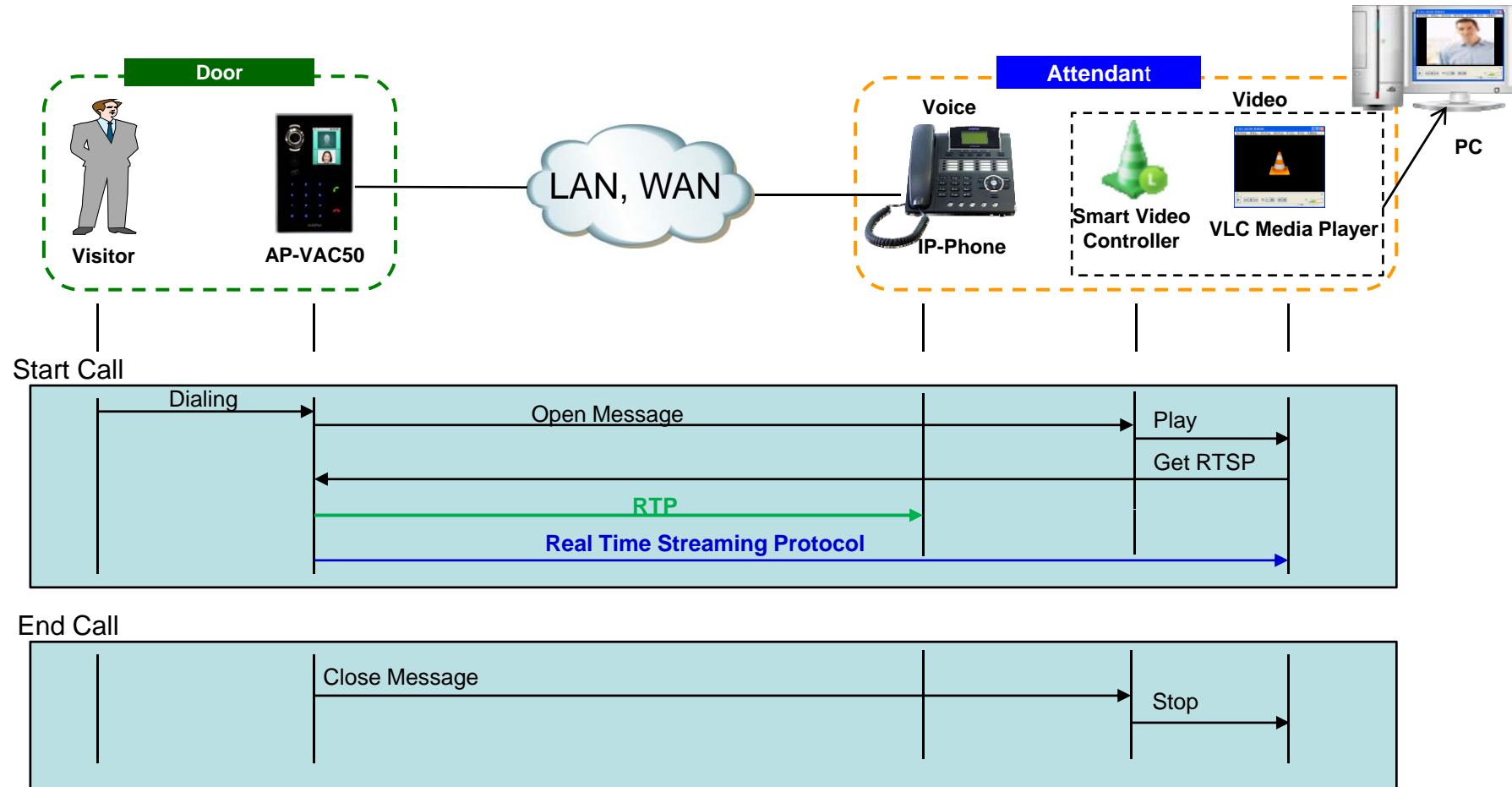





# Smart Video Controller Service Scenario





# AP-VP280 Video Phone

# IP Video Phone Comparison Table

	AP-VP500	AP-VP350	AP-VP300N	AP-VP280	AP-VP250	AP-VP230	AP-VP150	AP-VP120
								
LCD Size	12.1 Inch Touch Screen	7Inch Touch Screen	7Inch Touch Screen	7Inch Touch Screen	4.3Inch Touch Screen	5Inch Touch Screen	4.3Inch Touch Screen	4.3Inch
Camera	CCD	CCD	CCD	CMOS	CMOS	CMOS	CCD	CMOS
Video Codec	H.263 MPEG4 H.264	H.263 MPEG4 H.264	H.263 MPEG4 H.264	H.263 MPEG4 H.264	H.263 MPEG4 H.264	H.263 MPEG4 H.264	H.263 MPEG4 H.264	H.263 MPEG4 H.264
Signaling	H.323/SIP	H.323/SIP	H.323/SIP	H.323/SIP	H.323/SIP	H.323/SIP	H.323/SIP	H.323/SIP
Video MCU	N/A	4-Party Video MCU	N/A	N/A	N/A	N/A	N/A	N/A
Voice MCU	3-Party	3-Party	3-Party	3-Party	3-Party	3-Party	3-Party	3-Party
LAN Port	2	2	2	2	2	2	2	2
PoE	N/A	N/A	Support	N/A	Support	Support	Support	Support



# AP-VP280 Video Phone

# Video Phone

## AP-VP280 Video Phone

### Main Features

- 7 Inch LCD Display, Touch Screen
- H.323/SIP Concurrent VoIP Signaling Stack Embedded
- High-performance Video Codec Support
  - H.263, MPEG-4, JPEG, and H.264
- Powerful Image Resolution Support
  - QCIF(176x144), CIF(352x288), QVGA(320x240), and VGA(640x480)
- Two(2) 10/100Mbps Fast Ethernet (IP Share ,etc)
- G.711/G.726/G.723/G.729, etc
- Powerful Network Protocols (PPPoE, DHCP, Static Routing, etc)
- Rate Control for Video Traffic QoS
  - Ensuring Optimized Quality, Frame Rate with Limited Bandwidth
- Firmware Upgradeable Architecture
- VPMS (VoIP Plug&Play Management System) for Large Scale Deployment
- Advanced Voice QoS Mechanism

# Video Phone

AP-VP280 Video Phone

RISC  
CPU

High-end  
DSP

## Hardware Specification

- RISC Microprocessor Computing Power
- CMOS Image Sensor, Samsung LCD, Touch Screen
- High-end Programmable DSP Hardware Architecture
- Powerful Video Interface
  - RCA Video Input/Output, S-Video Output
- High quality Audio and Voice Interface
  - Stereo Audio Input & Output Connector
- Network Interface
  - Two(2) 10/100Mbps Fast Ethernet
  - One(1) RS-232C Console
  - One(1) USB 1.0 Interface
- PSTN Interface
  - One(1) FXO(RJ11) interface
- Power Supply
  - *External DC adaptor (5V)*



# Video Phone

AP-VP280 Video Phone

RISC  
CPU

High-end  
DSP

## Hardware Specification



# Video Phone

AP-VP280 Video Phone

## Hardware Specification

RISC  
CPU

High-end  
DSP

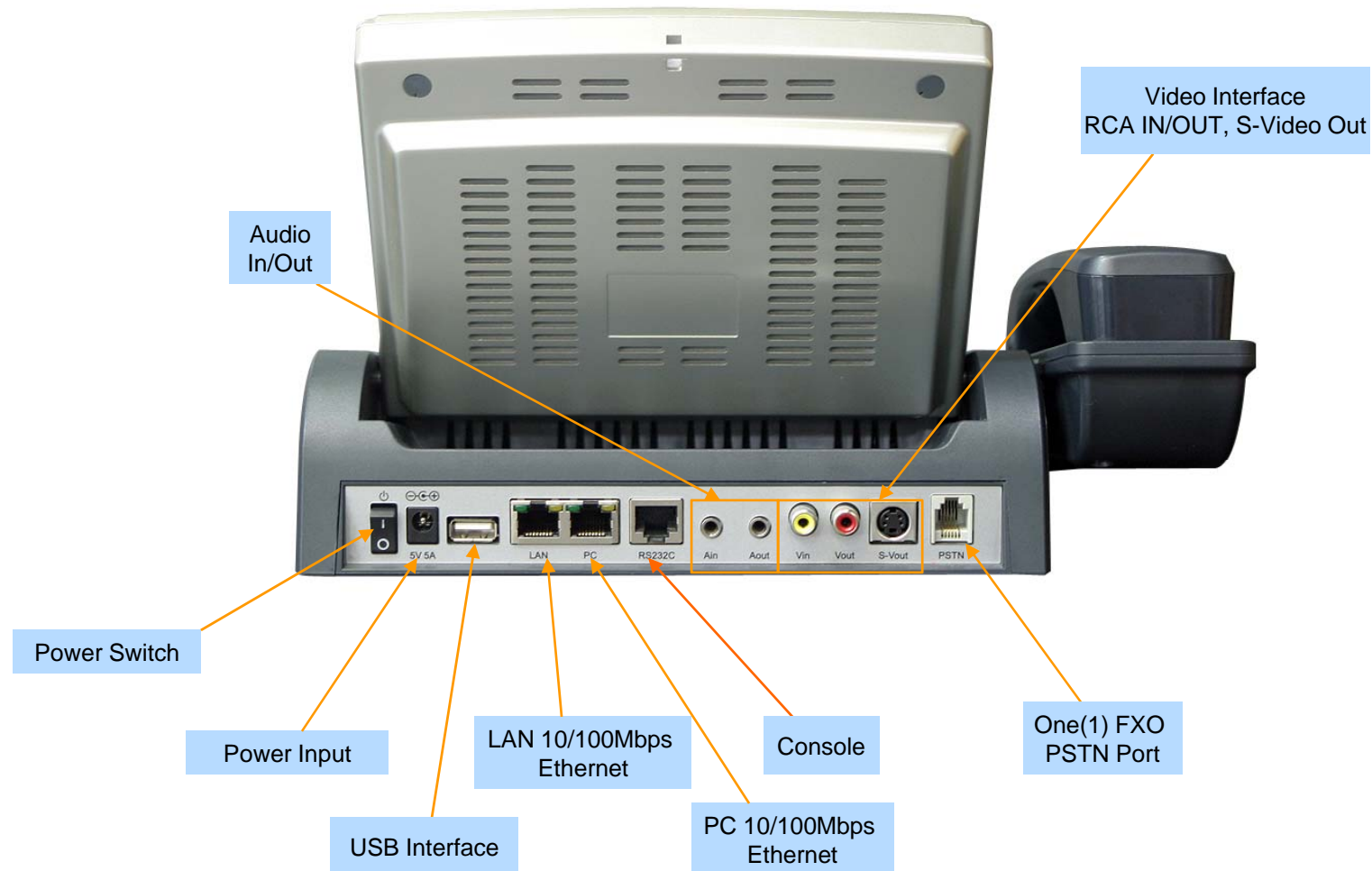



# Thank you!

**AddPac Technology Co., Ltd.**  
Sales and Marketing

Phone +82.2.568.3848 (KOREA)

FAX +82.2.568.3847 (KOREA)

E-mail : [sales@addpac.com](mailto:sales@addpac.com)