

IP Video Door Phone Solution



AP-VP280



AP-ACS1000
(Door Access Control Server)



AP-VAC20



AP-VAC50



AP-VAC70



AP-VAC100



AP-VAC200

AddPac

AddPac Technology

Sales and Marketing

www.addpac.com

Contents

- IP Video Door Phone Service Diagram
- IP Door Access Control Server Solution
 - AP-ACS1000
 - AP-ACS500
- IP Video Door Phone Solution
 - AP-VAC200(VGA)
 - AP-VAC100(VGA)
 - AP-VAC70(HD)
 - AP-VAC50(VGA)
 - AP-VAC20(VGA)
- Backend Solution
 - AP-VP280, AP-VP120 IP Video Phone
 - AP-VIC100 IP Video Intercom
 - AP-SMP100 IP Soft Video Phone

Conventional PBX Environment

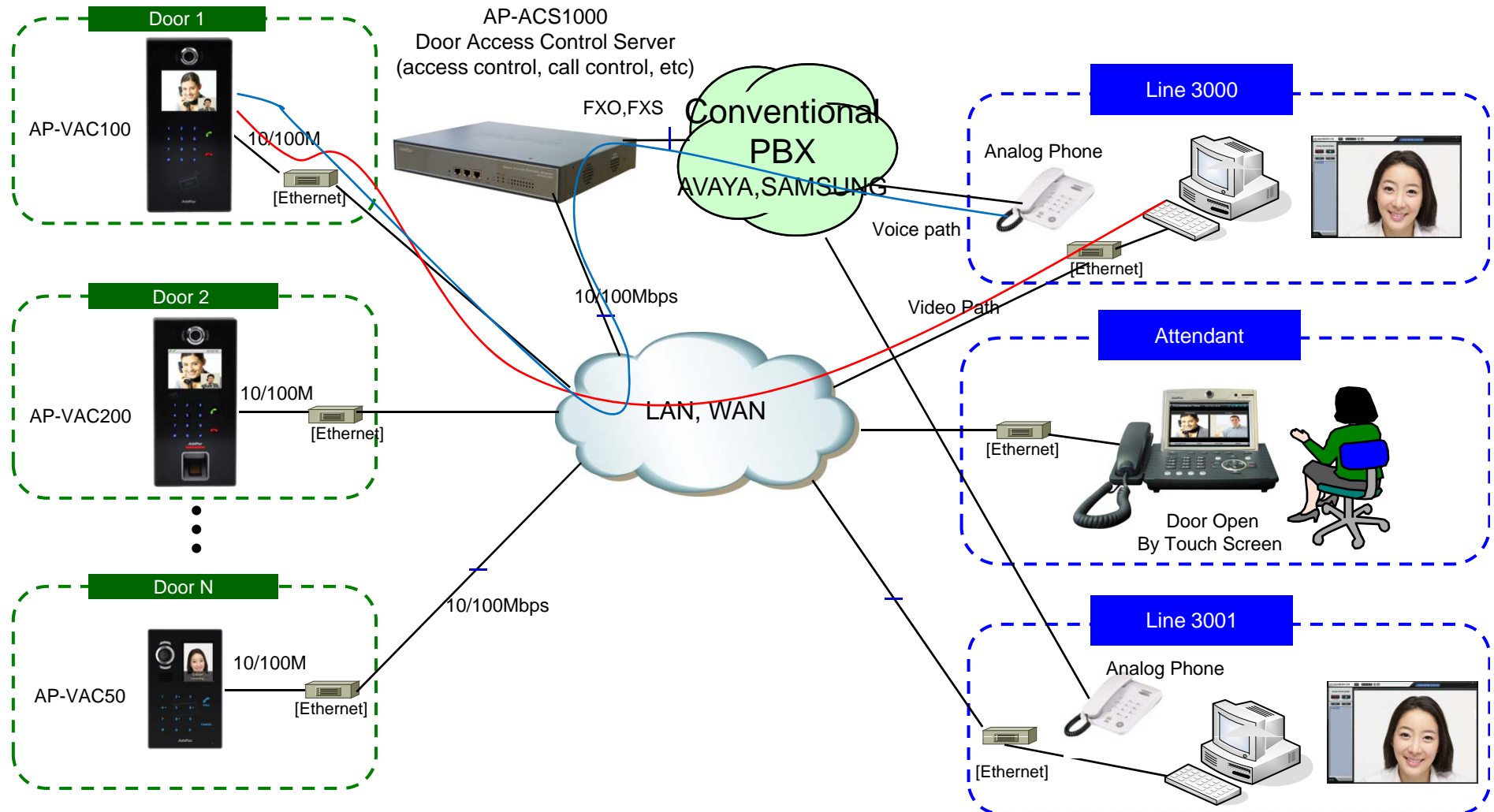

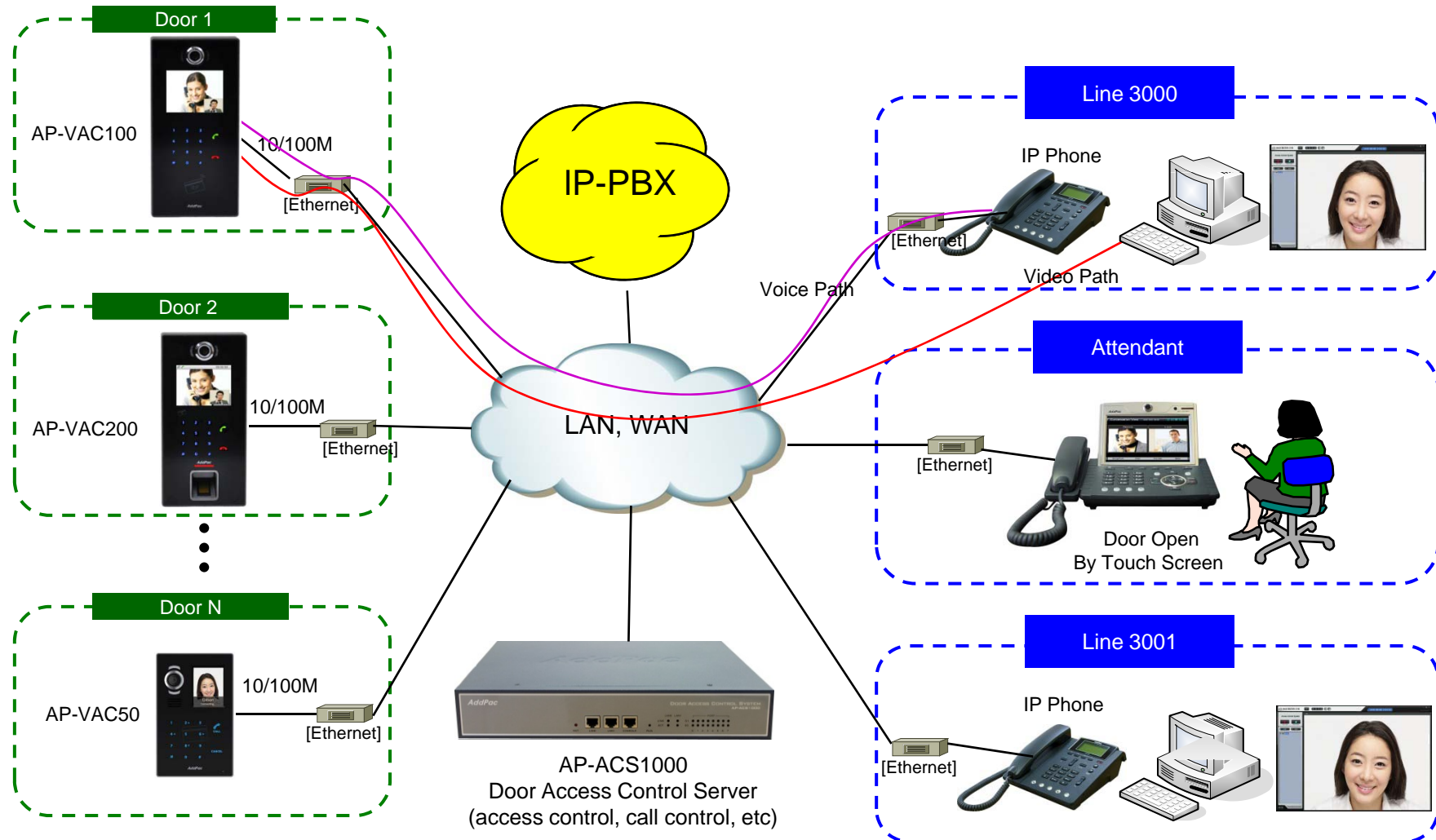

IP-PBX Environment





Door Access Control Server Solution

Door Access Control Server Comparison Table

Model		AP-ACS1000	AP-ACS500
Service Features			
Registration User Number		100	30
Concurrent Call User Number		30	15
IPv4/IPv6 Dual Stack Support		Support	Support
VoIP Signaling	Internal	SIP	SIP
	External	H.323/SIP	H.323/SIP
Powerful IVR, UMS, Media Service, User Presence Service		Support	Support
RTP Proxy Service (IPv6, Private IP)		Support	Support
LAN Port		2	2
VoIP Module Slots for PSTN		2 Slots (8 Port Module)	N/A
VoIP Interface		FXS,FXO,E1/T1	Option
Video Door Phone Control (RF card, etc)		Support	Support
Time & Attendance Management		Support(option)	Support (Option)

Contents

- DACS(Door Access Control Server) Network Diagram
- AP-ACS1000 Main Features & Hardware Specification
- AP-ACS500 Main Features & Hardware Specification
- DACS System Message Flow (Examples)
- DACM (Door Access Control Manager)
- Open API for Third Party Controller

Integrated Door Access Control and Call Control

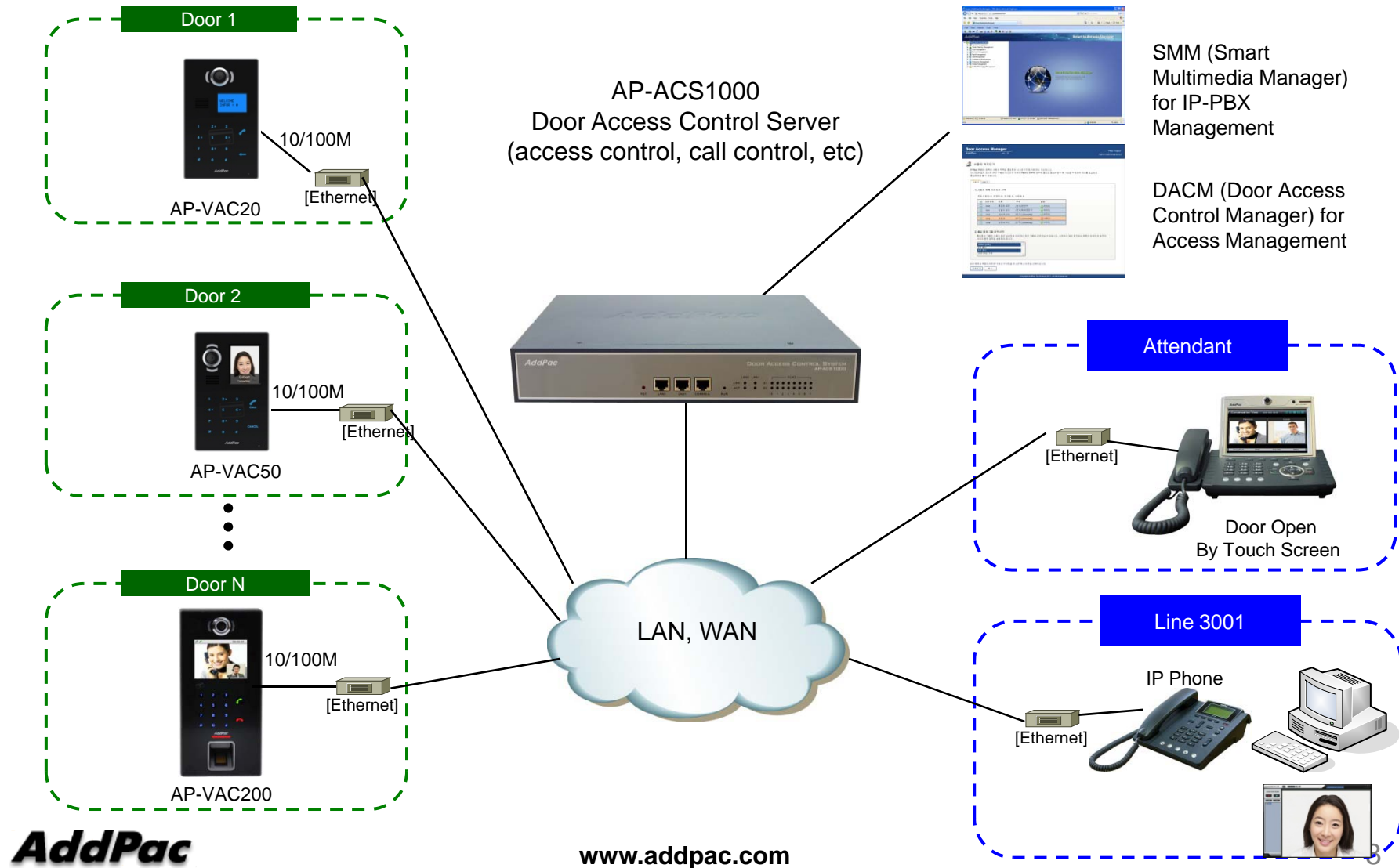

AddPac

www.addpac.com



AP-ACS1000 Door Access Control Server

Main Features

AP-ACS1000 DACS (Door Access Control System)

- Door Access Control Application System
- SIP Application Server, Proxy, Registrar and Location Server
- Multiple ITSP Trunk with SIP & H.323 Accounts Support
- Legacy PBX Interworking Service
- High Performance RISC & Programmable DSP Architecture
- Two(2) 10/100Mbps Fast Ethernet (IP Share ,etc)
- High Performance LAN-to-LAN Routing Capability
- Powerful Network Protocols (PPPoE, DHCP, Static Routing, etc)
- IPv4/IPv6 Dual Stack
- Firmware Upgradeable Architecture
- Smart Multimedia Manager for IP-PBX Management
- DACM(Door Access Control Manager)
- Advanced Voice QoS Mechanism
- Small, Light and Compact Design
- Two(2) VoIP Module Slots for Analog, Digital Interface

Main Features

AP-ACS1000 DACS (Door Access Control System)

- RISC Microprocessor Computing Power
- Main Chassis
 - Network Interface
 - Two(2) 10/100Mbps Fast Ethernet
 - One(1) RS-232C Console (RJ45)
 - Two(2) VoIP Module Slots for FXS, FXO etc



Hardware Specification

AP-ACS1000 DACS (Door Access Control System)

AP-ACS1000 Back Side



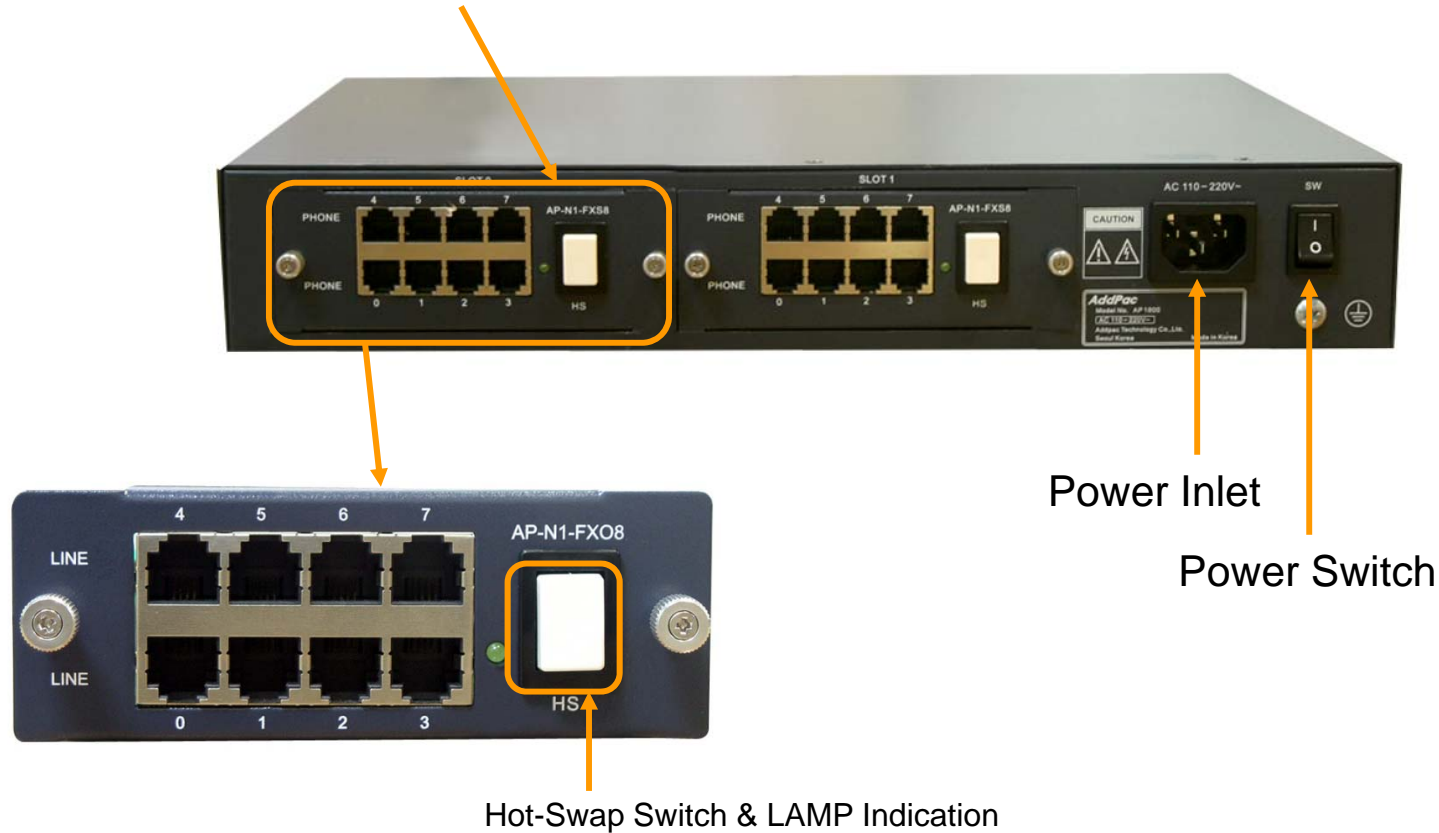

PSTN Interface Module



Hardware Specification

AP-ACS1000 DACS (Door Access Control System)

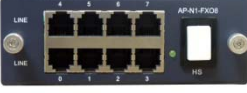
PSTN Interface Module

AP-N1-FXS8	 A black 8-port FXS voice processing module with RJ11 ports numbered 0-7 and a central switch labeled 'HS'.	8-Port FXS Voice Processing Module (8 x RJ11)
AP-N1-FXO8	 A black 8-port FXO voice processing module with RJ11 ports numbered 0-7 and a central switch labeled 'HS'.	8-Port FXO Voice Processing Module (8 x RJ11)
AP-N1-FXO4S4	 A black module with 4 FXO and 4 FXS ports, each with RJ11 connectors, and a central switch labeled 'HS'.	4-Port FXO and 4-Port FXS Voice Processing Module (8 x RJ11)
AP-N1-E1T1	 A black module with a green PCB, a single RJ45 port labeled 'E1/T1', and status LEDs for 'ACT' and 'LOS'.	1-Port VoIP Digital E1/T1 Interface Module(1xRJ45)



AP-ACS500 Door Access Control Server

Main Features

AP-ACS500 DACS (Door Access Control System)

- Door Access Control Application System
- SIP Application Server, Proxy, Registrar and Location Server
- Multiple ITSP Trunk with SIP & H.323 Accounts Support
- Legacy PBX Interworking Service
- High Performance RISC & Programmable DSP Architecture
- Two(2) 10/100Mbps Fast Ethernet (IP Share ,etc)
- High Performance LAN-to-LAN Routing Capability
- Powerful Network Protocols (PPPoE, DHCP, Static Routing, etc)
- IPv4/IPv6 Dual Stack
- Firmware Upgradeable Architecture
- Smart Multimedia Manager for IP-PBX Management
- DACM(Door Access Control Manager)
- Advanced Voice QoS Mechanism
- Small, Light and Compact Design
- Power Switch for Stability and Status LEDs



Hardware Specification

AP-ACS500 DACS (Door Access Control System)

- RISC Microprocessor Computing Power + High End Programmable DSP
- VoIP Gateway Interface
 - Model A: Basic Configuration
 - Model B: Two(2) FXO Port
 - Model C: Four(4) FXO Port
 - Model D: Two(2) FXS + Two(2) FXO Port
- Network Interface
 - Two(2) 10/100Mbps Fast Ethernet (RJ45)
- USB Interface
 - One(1) USB Host Mode Interface for USB Memory and Wireless LAN
- Power Supply
 - External Power Adaptor
- Power On/Off Switch
- Power LED, LAN LEDs, FXO Port LEDs





DACS System Message Flow

DACS System Message Flow

Registration and KeepAlive

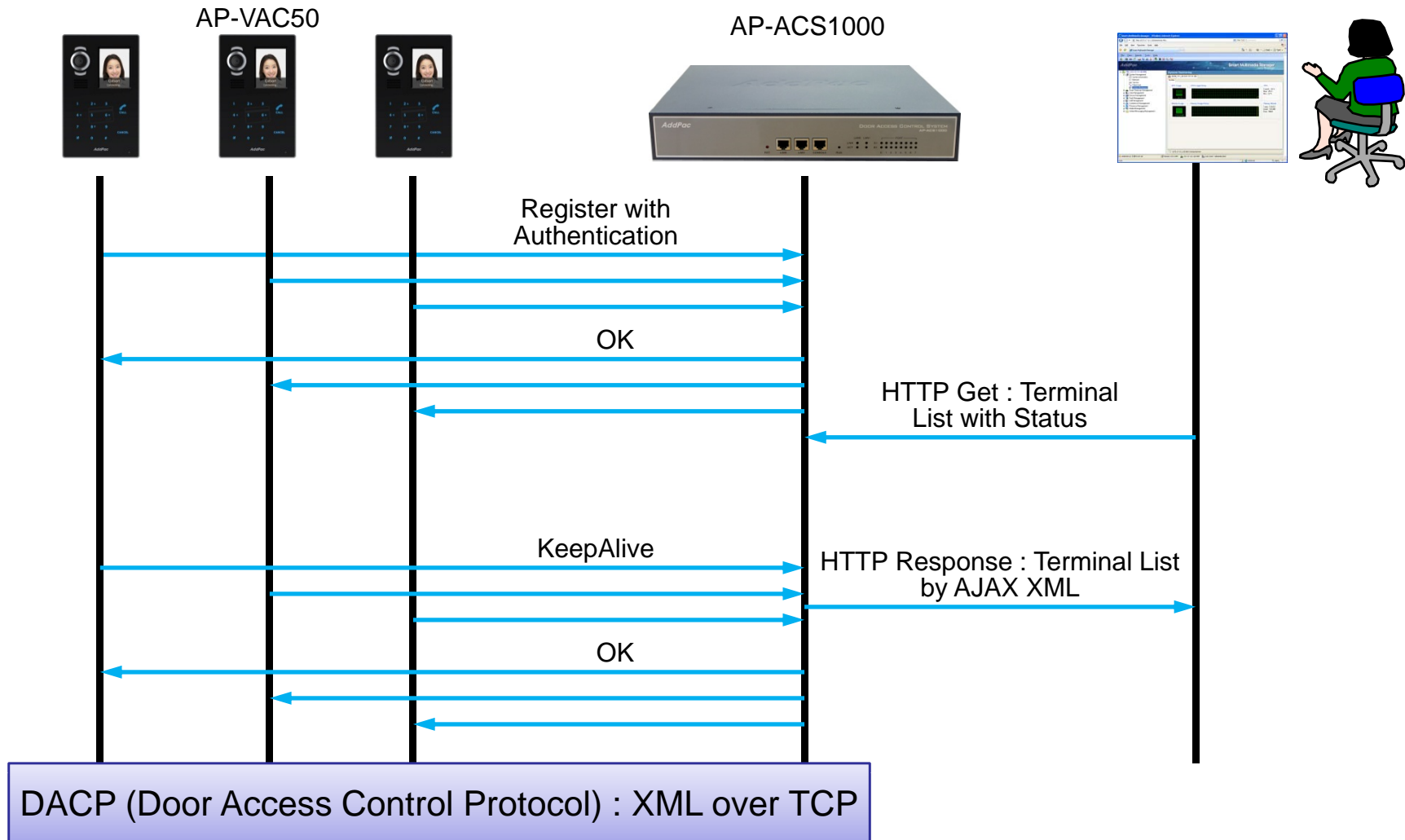

DACS System Message Flow

Access Privilege and Schedule Download

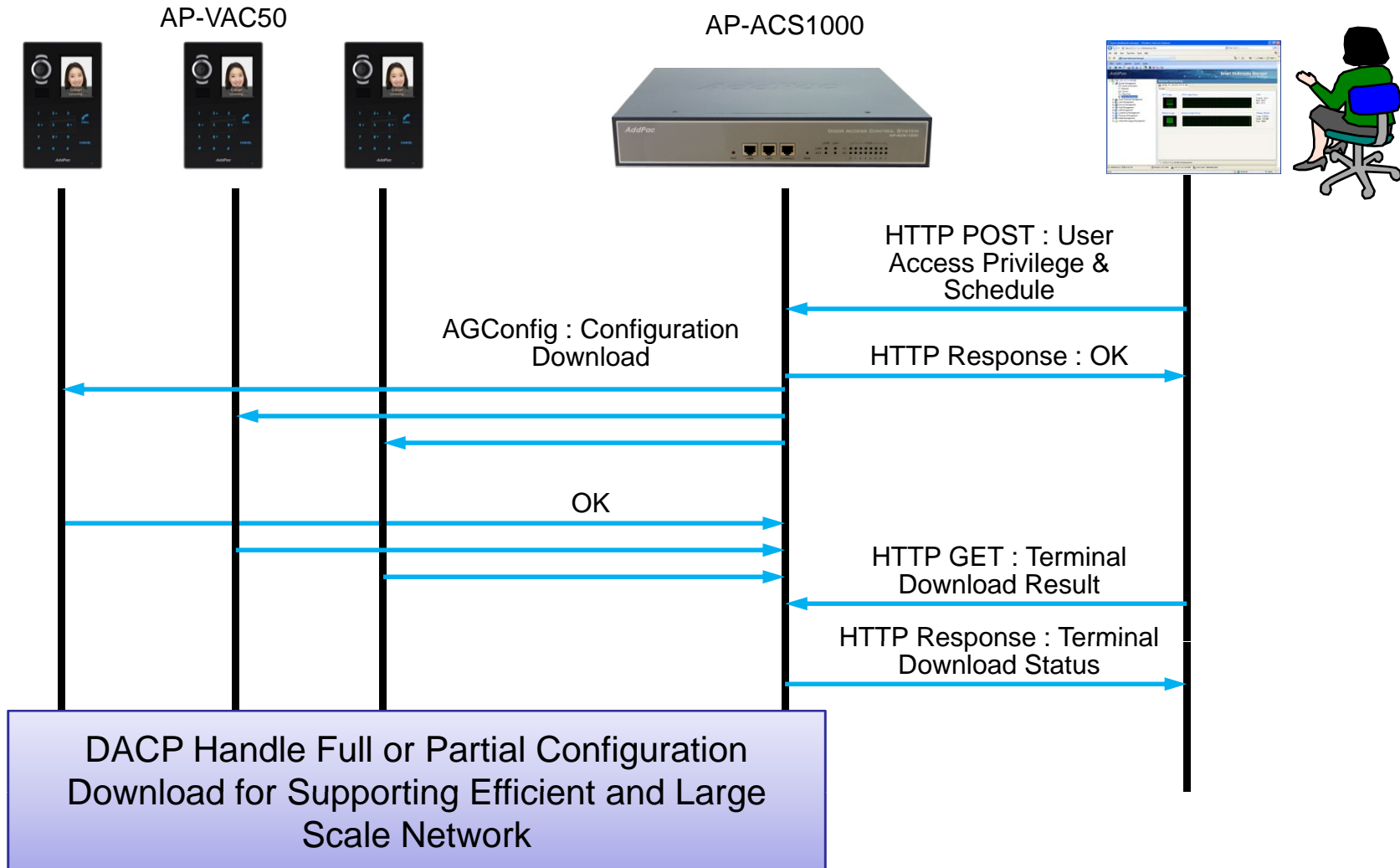

DACS System Message Flow

RF Card Read/Write and Registration

AP-VAC50



AP-ACS1000

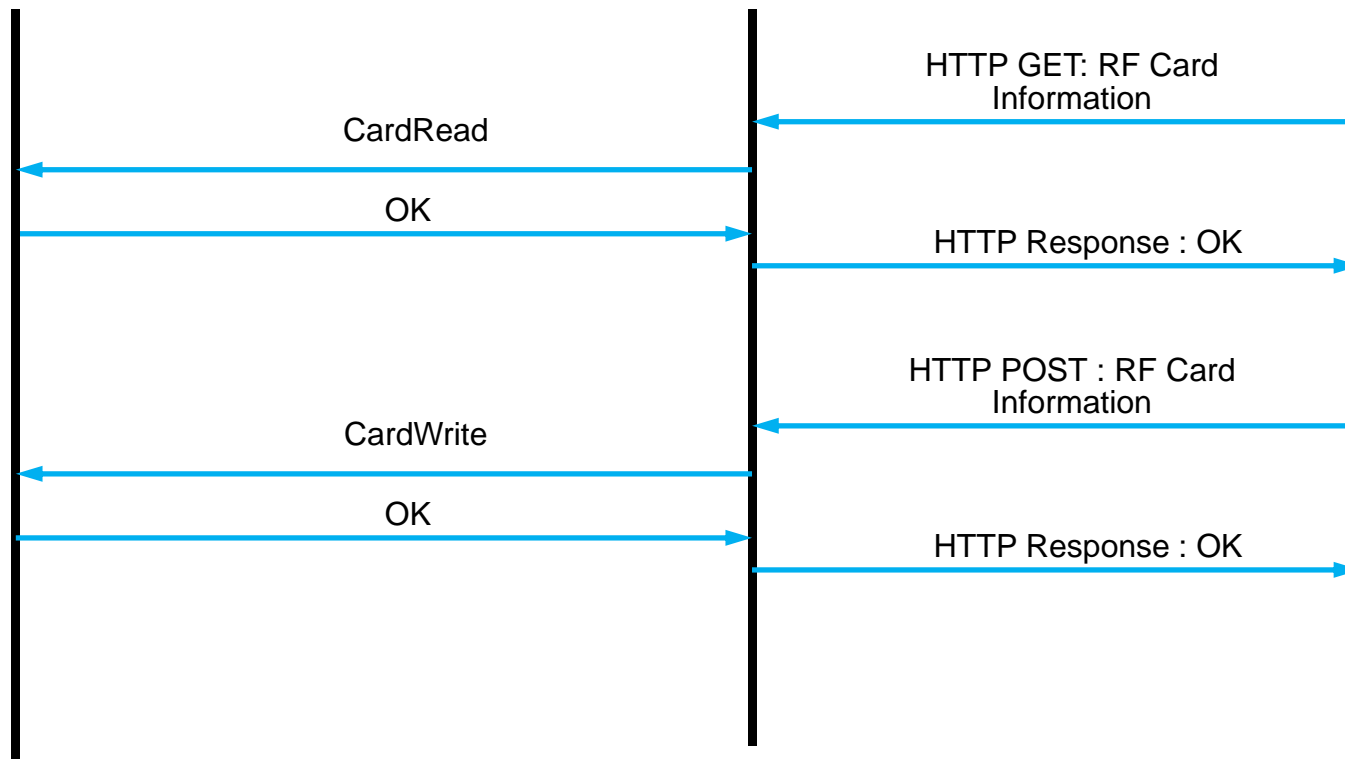
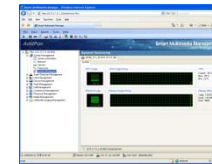

DACS System Message Flow

Door Open by RF Card or Password

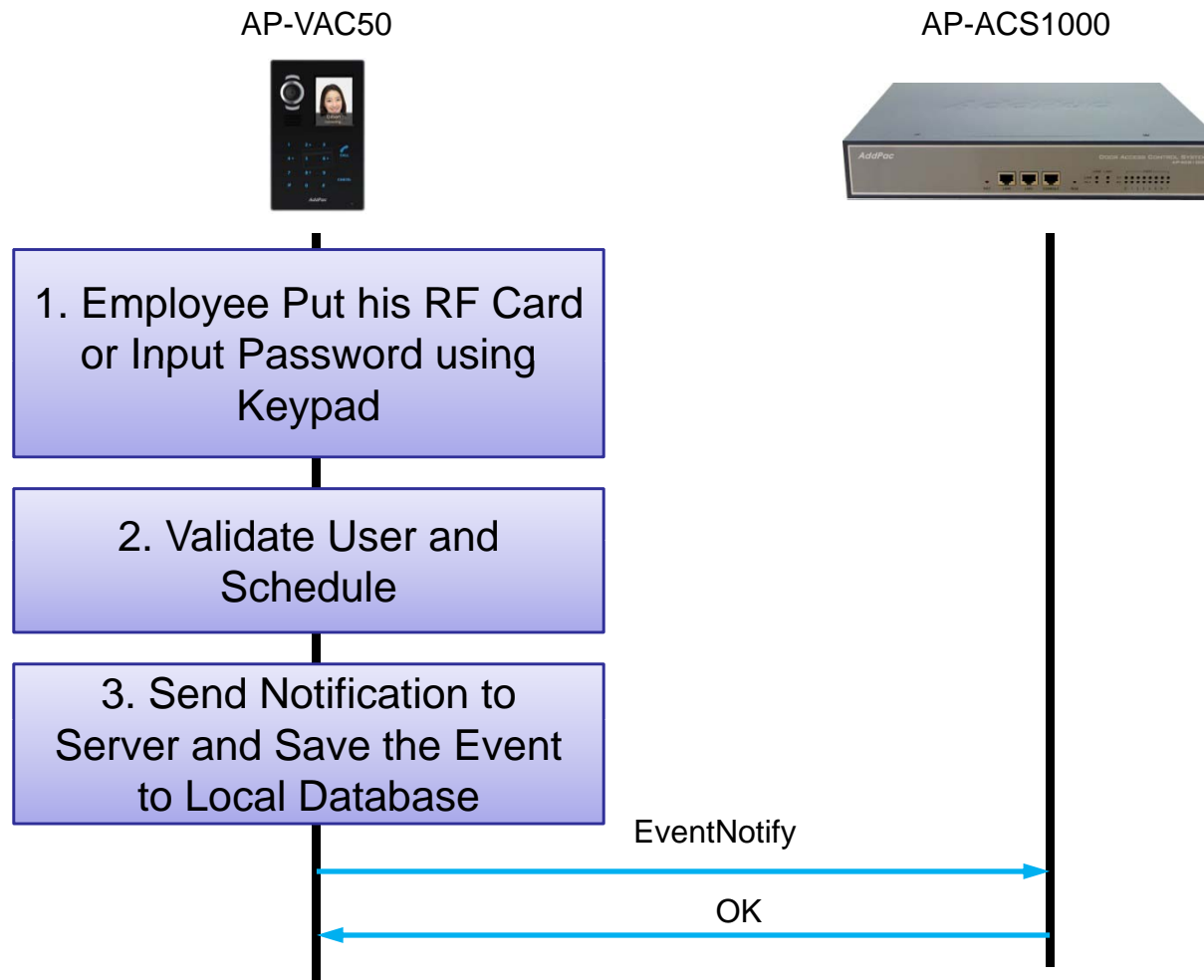

DACS System Message Flow

Door Open by Other Terminal

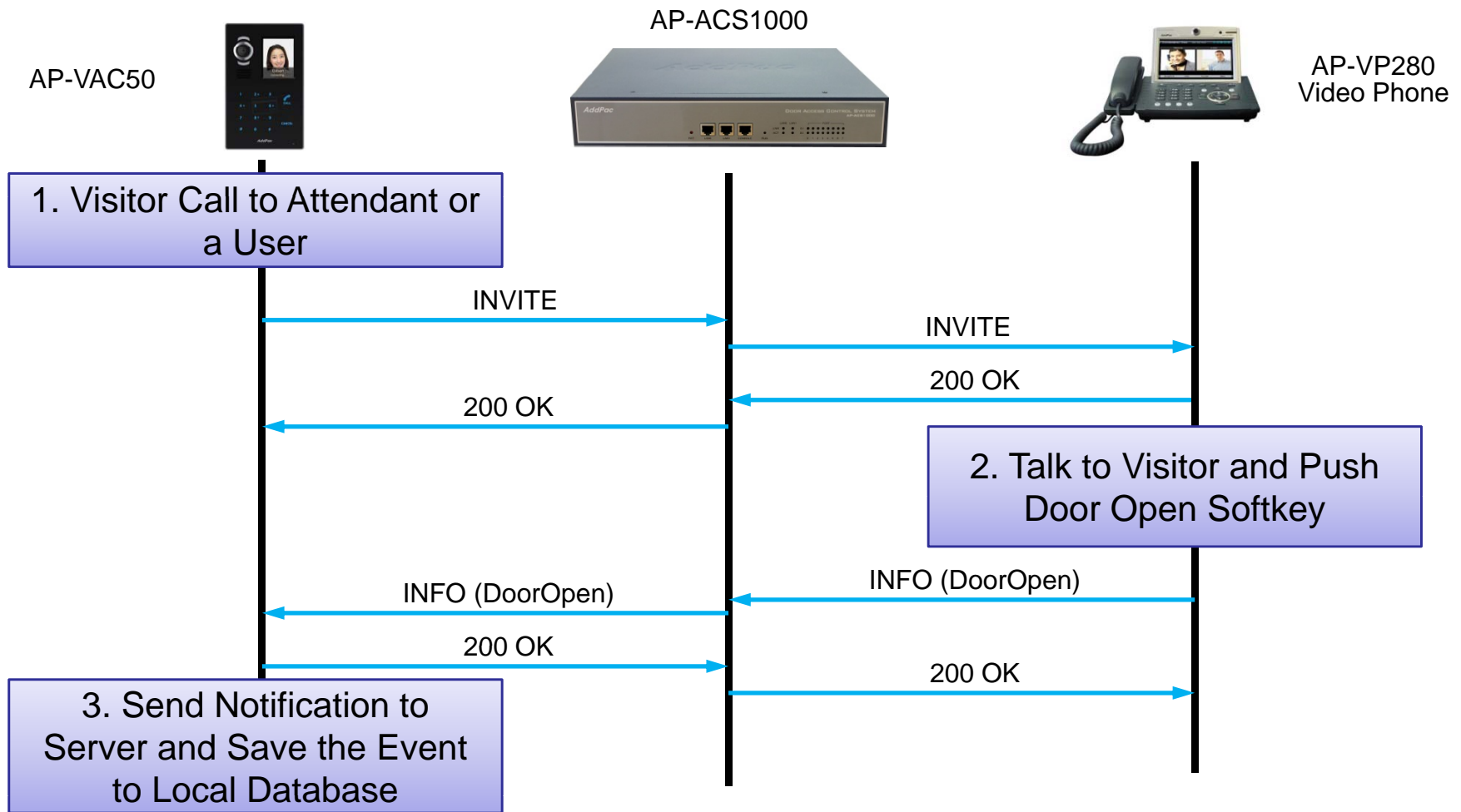



Door Access Control Manager

DACM (Door Access Control Manager)

Main Web Page

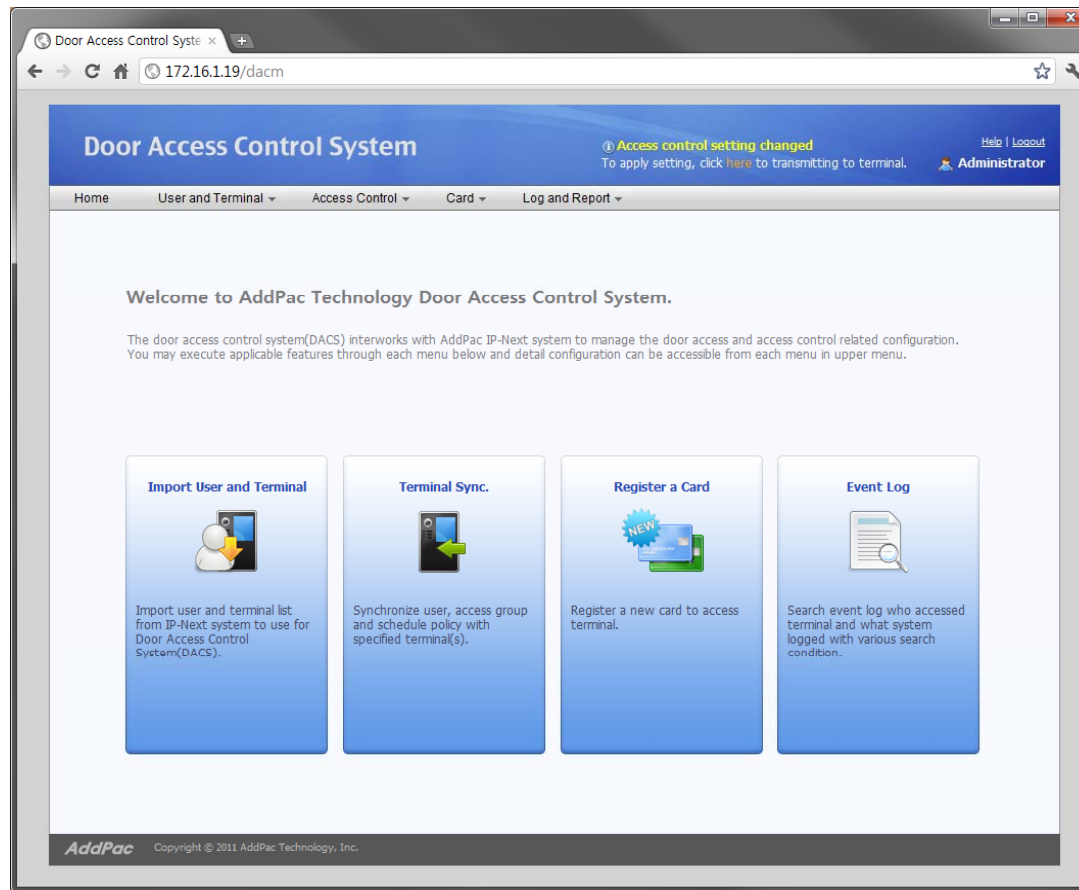

DACM (Door Access Control Manager)

Import User and Terminal

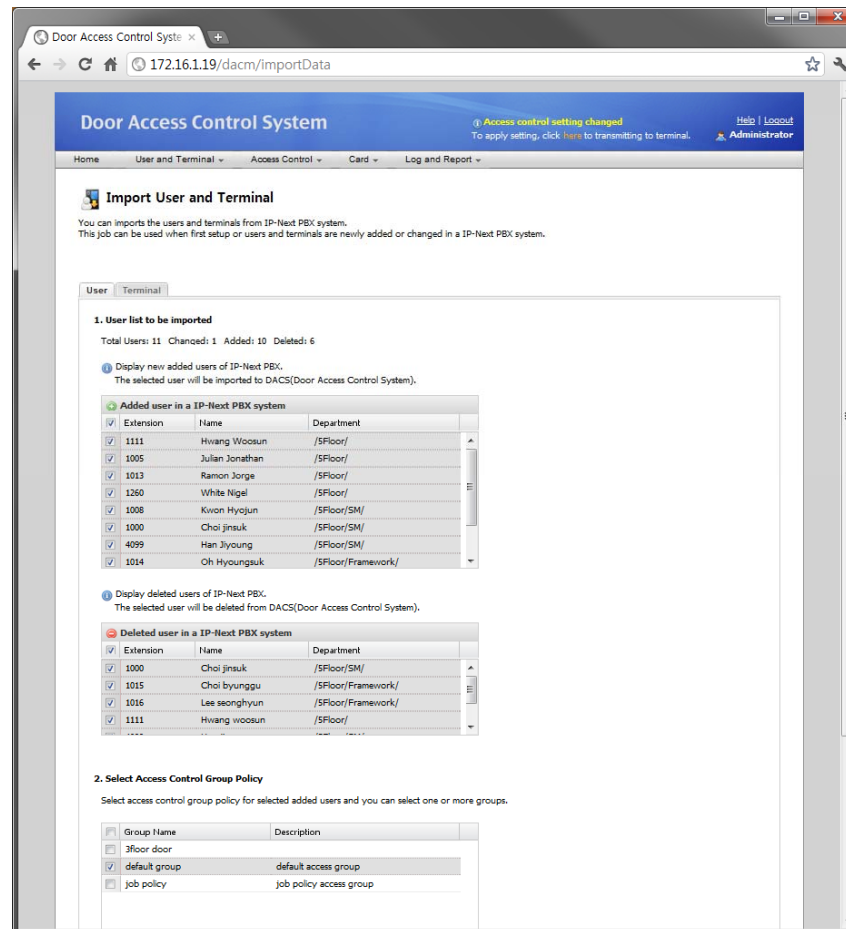

DACM (Door Access Control Manager)

User List

The screenshot shows a web browser window displaying the 'Door Access Control System' user list. The page title is 'Door Access Control System' and the URL is '172.16.1.19/dacm/userList'. A notification at the top right states 'Access control setting changed' with a link to 'here' and a 'Logout' button. The user is logged in as 'Administrator'. The main content area is titled 'User List' and includes a search bar with a dropdown set to 'All Users' and an 'Import User' button. Below the search bar is a table with the following data:

	Extension	Name	Department	Access Policy	Date Created	Modify	Delete
1	1000	Choi jinsuk	/SFloor/SM/	Access Allow	2011-07-22 15:50:01		
2	1008	Kwon hyojun	/SFloor/SM/	Access Allow	2011-07-22 15:50:00		
3	1014	Oh hyongsuk	/SFloor/Framework/	Access Allow	2011-07-22 15:50:01		
4	1015	Choi byunggu	/SFloor/Framework/	Access Allow	2011-07-22 15:50:01		
5	1016	Lee seonghyun	/SFloor/Framework/	Access Allow	2011-07-22 15:50:01		

At the bottom of the page, there is a pagination control showing 'Page 1 of 1' and a 'Total: 5' indicator. The footer contains the 'AddPac' logo and 'Copyright © 2011 AddPac Technology, Inc.'.

DACM (Door Access Control Manager)

Terminal List

Door Access Control System

Access control setting changed
To apply setting, click [here](#) to transmitting to terminal.

Help | Logout
Administrator

Home User and Terminal Access Control Card Log and Report

Terminal List

Display the registered door phone lists imported from IP-Next PBX system.

Import Terminal

	Terminal Name	Description	Status	Extension	IP Address	Model Name	Version	Date Created	Detail View
1	2floor door terminal	2Floor door ter...	Connected	1006	172.16.10.4	AP-VAC50		2011-07-29 17:08:50	
2	3floor door terminal	3Floor door ter...	Connected	1002	172.16.10.1	AP-VAC20	8.50.001	2011-07-22 15:50:01	
3	5floor door terminal	5Floor door ter...	Connected	1005	172.16.10.2	AP-VAC50		2011-07-29 17:08:50	
4	The main entrance d...	The main entran...	Connected	Required setting	172.16.10.3	AP-VAC100		2011-07-29 17:08:50	

Page 1 of 1 Total: 4

AddPac Copyright © 2011 AddPac Technology, Inc.

DACM (Door Access Control Manager)

Access Control Group Management

The screenshot displays the 'Door Access Control System' web interface. The browser address bar shows '172.16.1.19/dacm/accessGroupList'. The page title is 'Door Access Control System'. A notification banner at the top right states 'Access control setting changed' and provides instructions to apply settings. The navigation menu includes 'Home', 'User and Terminal', 'Access Control', 'Card', and 'Log and Report'. The main content area is titled 'Access Control Group' and includes a brief description: 'You can define a new Access Control Group with one or more terminals, users and schedule policy. Also, you can adjust priority of access control group using up/down arrow (or mouse drag/drop)'. A table lists existing groups with columns for Group Name, Description, Schedule Policy, Date Created, Modify, and Delete. The table contains three entries: '3floor door', 'job policy', and 'default group'. A 'Add a Access Control Group' button is located above the table.

Group Name	Description	Schedule Policy	Date Created	Modify	Delete
3floor door		All Allow	2011-06-28 11:37:13		
job policy	job policy access group	working day	2011-07-04 17:06:47		
default group	default access group	All Allow	2011-06-28 11:37:13		

DACM (Door Access Control Manager)

Configuration Download to Terminal

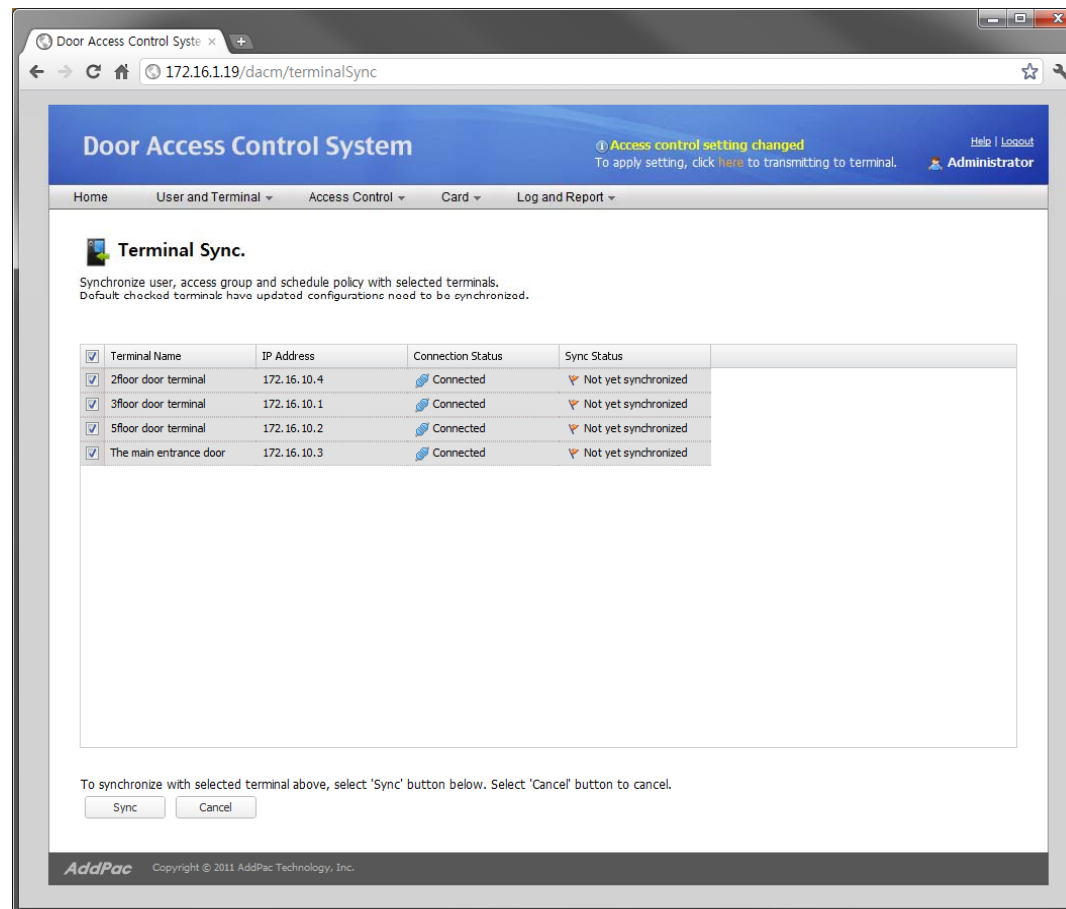

Door Access Control System

Access control setting changed
To apply setting, click [here](#) to transmitting to terminal.

Help | Logout
Administrator

Home User and Terminal Access Control Card Log and Report

Terminal Sync.

Synchronize user, access group and schedule policy with selected terminals.
Default checked terminals have updated configurations need to be synchronized.

<input checked="" type="checkbox"/>	Terminal Name	IP Address	Connection Status	Sync Status
<input checked="" type="checkbox"/>	2floor door terminal	172.16.10.4	Connected	Not yet synchronized
<input checked="" type="checkbox"/>	3floor door terminal	172.16.10.1	Connected	Not yet synchronized
<input checked="" type="checkbox"/>	5floor door terminal	172.16.10.2	Connected	Not yet synchronized
<input checked="" type="checkbox"/>	The main entrance door	172.16.10.3	Connected	Not yet synchronized

To synchronize with selected terminal above, select 'Sync' button below. Select 'Cancel' button to cancel.

AddPac Copyright © 2011 AddPac Technology, Inc.

DACM (Door Access Control Manager)

RF Card Management

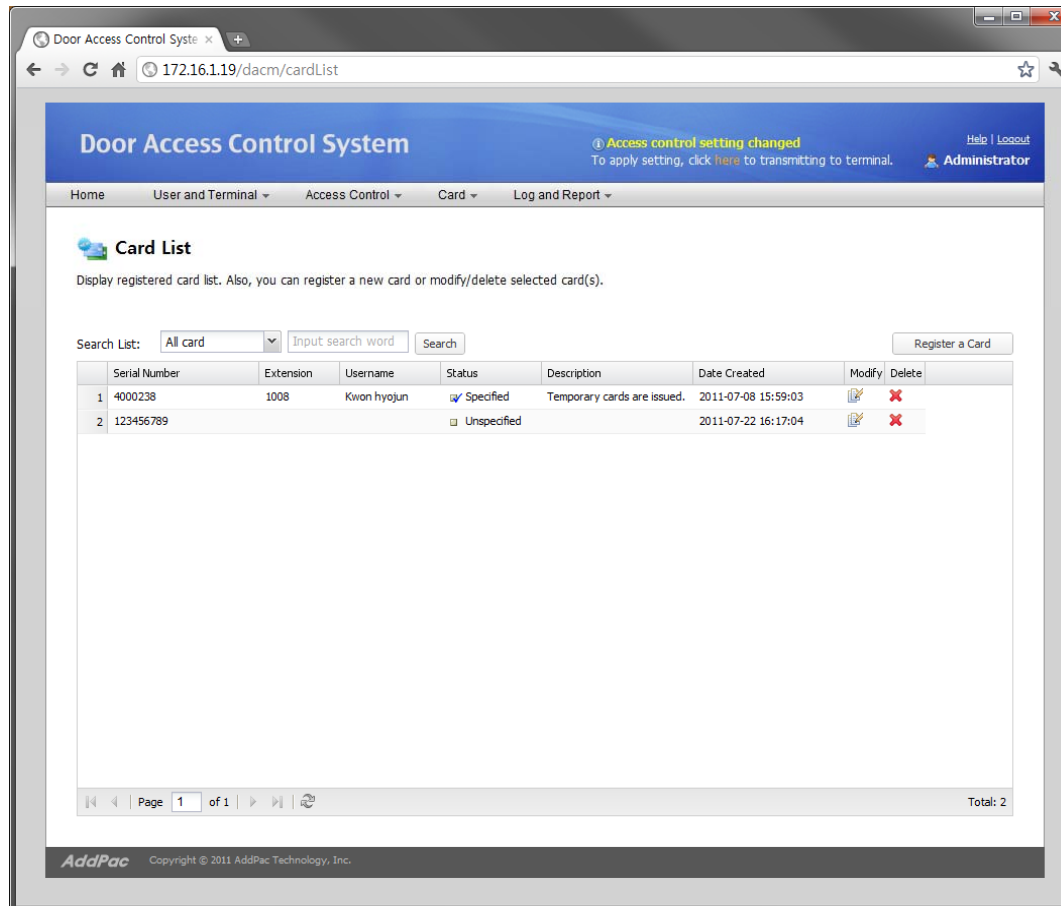

The screenshot displays the 'Door Access Control System' web interface. The browser address bar shows '172.16.1.19/dacm/cardList'. The page title is 'Door Access Control System'. A notification banner at the top right states 'Access control setting changed' with instructions to click a link to transmit settings to the terminal. The user is logged in as 'Administrator'. The main content area is titled 'Card List' and includes a search bar with a dropdown menu set to 'All card' and a 'Search' button. Below the search bar is a table with the following data:

Serial Number	Extension	Username	Status	Description	Date Created	Modify	Delete	
1	4000238	1008	Kwon hyojun	✓ Specified	Temporary cards are issued.	2011-07-08 15:59:03		
2	123456789			☐ Unspecified	2011-07-22 16:17:04			

At the bottom of the page, there is a pagination control showing 'Page 1 of 1' and a 'Total: 2' indicator. The footer contains the 'AddPac' logo and the text 'Copyright © 2011 AddPac Technology, Inc.'

DACM (Door Access Control Manager)

Access Log Management

The screenshot shows a web browser window displaying the 'Door Access Control System' interface. The page title is 'Door Access Control System' and the URL is '172.16.1.19/dacm/eventLog'. The user is logged in as 'Administrator'. A notification banner at the top right states 'Access control setting changed' with a link to 'Apply setting, click here to transmitting to terminal.' The main content area is titled 'Event Log' and includes a search filter section with fields for 'Duration' (11-07-10 to 11-08-09), 'User Extension Number', and 'Event Level' (set to 'Error'). Below the search filters is a table of event logs with columns for 'Time', 'Level', 'User Extension', and 'Event'. The table contains 7 entries. At the bottom of the page, there is a pagination control showing 'Page 1 of 1' and a 'Total: 7' indicator. The footer includes the 'AddPac' logo and 'Copyright © 2011 AddPac Technology, Inc.'

	Time	Level	User Extension	Event
1	2011-07-15 10:27:27	Warning	1000	authentication failure
2	2011-07-15 11:25:27	Notice	1000	registration success
3	2011-07-15 12:21:27	Notice	1200	registration success
4	2011-07-16 09:27:27	Information	1201	door opened
5	2011-07-16 11:27:27	Information	1007	registration success
6	2011-07-16 17:12:00	Notice		security profile downloading completed
7	2011-07-17 18:00:00	Notice		system started



AP-ACS1000 Open API

Open API

Open API for 3'rd Party Management System

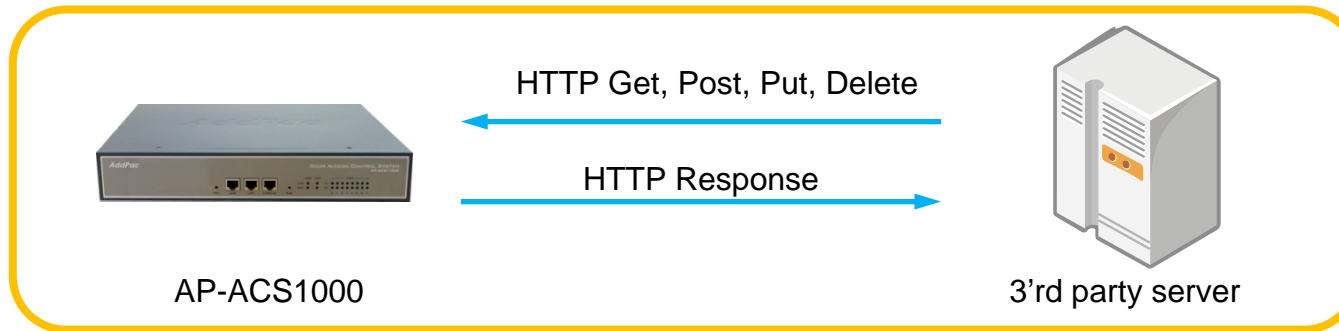

- HTTP based RESTful Open API for Door Access Management
- XML based Flexible and Expandable Message Contents
- Provides More than 40 APIs as Bellow
 - user_list(GET), user(GET, POST, PUT, DELETE), ...
 - terminal_list(GET), terminal(GET, POST, PUT, DELETE), ...
 - access_group(GET, POST, PUT, DELETE), priority (PUT), ...
 - card_list(GET), card(POST, PUT, DELETE), ...
 - schedule_template(GET, POST, PUT, DELETE), rule(GET, POST, PUT, DELETE) ,...



IP Video Door Phones

IP Video Door Phone Comparison Table

Model	AP-VAC200	AP-VAC100	AP-VAC70	AP-VAC50	AP-VAC20
Service Features					
Duplex (Voice)	Full Duplex	Full Duplex	Full Duplex	Full Duplex	Full Duplex
Key Pad	3x4 Key Support	3x4 Key Support	3x4 Key Support	3x4 Key Support	3x4 Key Support
LCD	3.5 Inch	3.5 Inch	2inch LCD	2inch LCD	Graphic LCD
RF Card	Support	Support	Support	Support	Support
Fingerprint	Support	N/A	N/A	N/A	N/A
Camera Sensor	SD(VGA)	SD(VGA)	HD Camera	SD(VGA)	SD(VGA)
Video Codec	SD, H.264/MPEG4	SD, H.264/MPEG4	HD, H.264/MPEG4	SD, H.264/MPEG4	SD, H.264/MPEG4
Voice Codec	G.711	G.711	G.711	G.711	G.711
Signaling	H.323/SIP	H.323/SIP	H.323/SIP	H.323/SIP	H.323/SIP
MIC & Speaker Phone	Support	Support	Support	Support	Support
LAN Port	1	1	1	1	1
PoE(Optional)	Support	Support	Support	Support	Support



AP-VAC200 IP Video Door Phone

Main Features

AP-VAC200 IP Video Door Phone

- High Performance IP Video Door Phone Solution
- Video Camera, 3x4 Key, 3.5 Inch TFT Color LCD, Internal MIC & Speaker
- Fingerprint Recognition Support
- RF Card Support
- H.323/SIP Concurrent VoIP Signaling Stack Embedded
- High-performance Video/Voice Codec Support
 - H.264/MPEG4, G.711, etc
- One(1) 10/100Mbps Fast Ethernet
- PoE(Power over Ethernet) Support
- High Quality Speaker Phone Features
- Powerful Acoustic Echo Canceller
- Powerful Network Protocols (PPPoE, DHCP, Static Routing, etc)
- Firmware Upgradeable Architecture
- Advanced Voice QoS Mechanism

Hardware Specification

AP-VAC200 IP Video Door Phone

- RISC+DSP Microprocessor Computing Power (Dual Processor Architecture)
- Audio and Voice Interface
 - Internal MIC
 - Internal Speaker
 - 3 x 4 key PAD
- Video Camera Interface
- 3.5 Inch TFT Color LCD Interface
- RF Card Interface
- Fingerprint Recognition Module Interface
- Network Interface
 - One(1) 10/100Mbps Fast Ethernet
- Alarm & Relay Out Interface (door open, etc)
- RS232/RS422/RS485 Interface
- Power Supply
 - Power over Ethernet (Option)

RISC
CPU

High-end
DSP



AddPac

– External Power Supply

www.addpac.com

Hardware Specification

AP-VAC200 IP Video Door Phone

RISC
CPU

High-end
DSP

Front Side

Internal Speaker

Video Camera

LED Side Light

RF Card Sensor

Status LED

Fingerprint
Recognition

TFT LCD Display

Remote Image

Local Image

3 x 4 Dial Key

STILL Chassis

Internal MIC Input

AddPac

www.addpac.com

39

Hardware Specification

AP-VAC200 IP Video Door Phone

RISC
CPU

High-end
DSP

Back Side

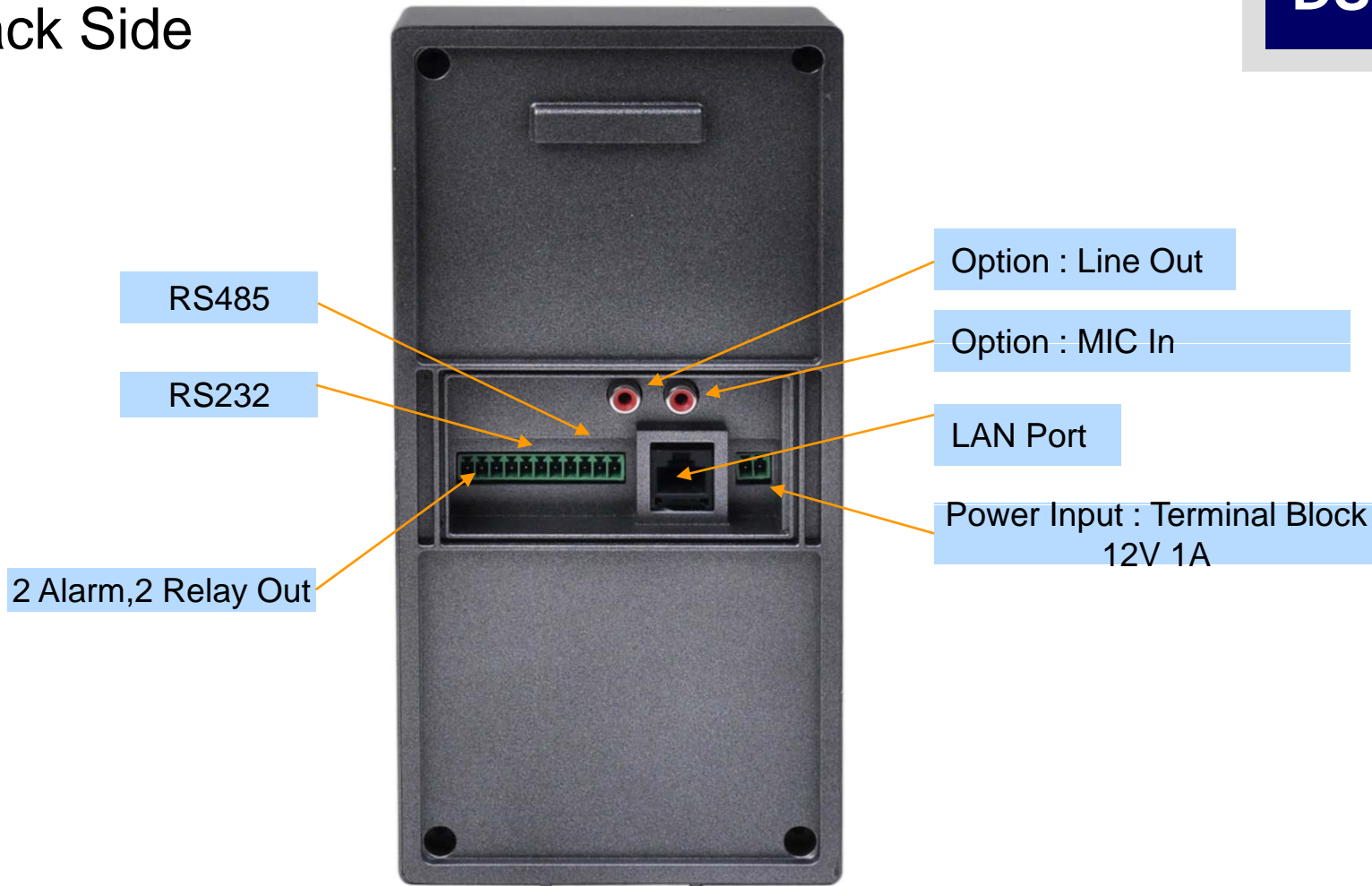



AP-VAC100 IP Video Door Phone

Main Features

AP-VAC100 IP Video Door Phone

- High Performance IP Video Door Phone Solution
- Video Camera, 3x4 Key, TFT Color LCD, Internal MIC & Speaker
- H.323/SIP Concurrent VoIP Signaling Stack Embedded
- RF Card Interface
- High-performance Video/Voice Codec Support
 - H.264/MPEG4, G.711, etc
- One(1) 10/100Mbps Fast Ethernet
- PoE(Power over Ethernet) Support
- High Quality Speaker Phone Features
- Powerful Acoustic Echo Canceller
- Powerful Network Protocols (PPPoE, DHCP, Static Routing, etc)
- Firmware Upgradeable Architecture
- Advanced Voice QoS Mechanism

Hardware Specification

AP-VAC100 IP Video Door Phone

RISC
CPU

High-end
DSP

- RISC+DSP Microprocessor Computing Power (Dual Processor Architecture)
- Audio and Voice Interface
 - Internal MIC
 - Internal Speaker
 - 3 x 4 key PAD
- Video Camera Interface
- 3.5 Inch TFT Color LCD Interface
- RF Card Interface
- Network Interface
 - One(1) 10/100Mbps Fast Ethernet
- Alarm & Relay Out Interface (door open, etc)
- RS232/RS422/RS485 Interface
- Power Supply
 - Power over Ethernet (Option)
 - External Power Supply

Hardware Specification

AP-VAC100 IP Video Door Phone

RISC
CPU

High-end
DSP

Front Side

Internal Speaker

Video Camera

LED Side Light

RF Card Sensor

TFT LCD Display

Remote Image

Local Image

3 x 4 Dial Key

STILL Chassis

Internal MIC Input

AddPac

www.addpac.com

Hardware Specification

AP-VAC100 IP Video Door Phone

RISC
CPU

High-end
DSP

Back Side

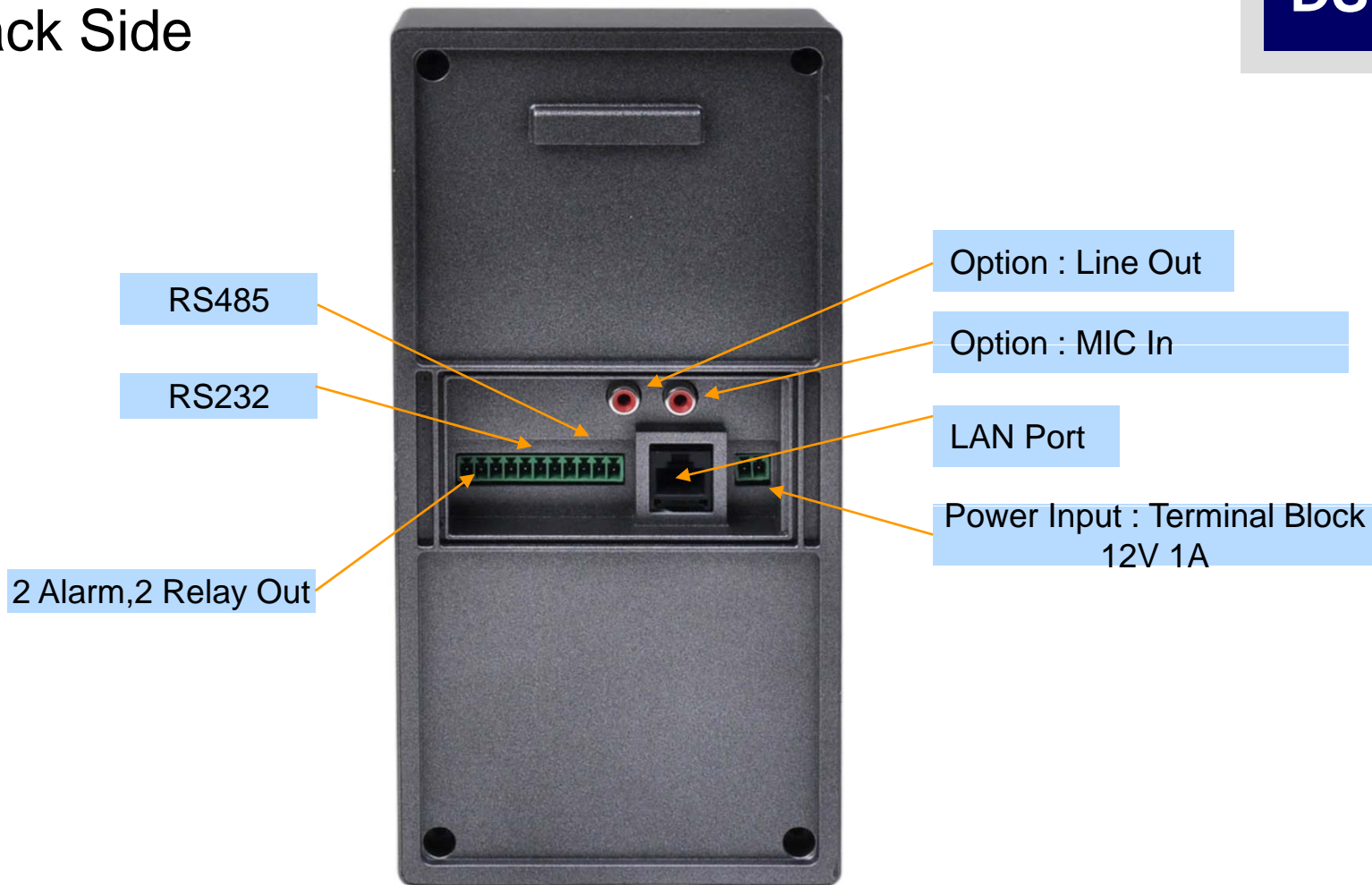



AP-VAC70 IP Video Door Phone

Main Features

AP-VAC70 IP HD Video Door Phone

- High Performance IP HD Video Door Phone Solution
- 3x4 Key, TFT Color LCD, Internal MIC & Speaker
- Wide Dynamic Range(WDR) HD Video Camera CMOS Image Sensor
- H.264 720P HD Video Codec Support
- High Quality 2.4 Inch LCD, 320 x 240 Video Resolution
- SIP VoIP Signaling Stack Embedded
- High-performance Video/Voice Codec Support
 - H.264, G.711, etc
- One(1) 10/100Mbps Fast Ethernet
- PoE(Power over Ethernet) Support
- High Quality Speaker Phone Features
- Powerful Acoustic Echo Canceller Chip Embedded
- Powerful Network Protocols (PPPoE, DHCP, Static Routing, etc)
- Firmware Upgradeable Architecture
- Advanced Voice QoS Mechanism

Hardware Specification

AP-VAC70 IP HD Video Door Phone

RISC
CPU

High-end
DSP

- RISC+DSP Microprocessor Computing Power
- Audio and Voice Interface
 - Internal MIC
 - Internal Speaker
 - 3 x 4 key PAD
- HD Video Camera Image Sensor
- TFT Color LCD Interface
 - 2.4 Inch LCD, 320 x 240 Video Resolution
- Network Interface
 - One(1) 10/100Mbps Fast Ethernet
- RF Card Interface
- Alarm & Relay Out Interface (door open, etc)
- RS232/RS485 Interface
- External RCA Audio Line Out and MIC In (back side)
- Power Supply
 - Power over Ethernet (Option)
 - External Power Supply



Hardware Specification

AP-VAC70 IP HD Video Door Phone

RISC
CPU

High-end
DSP

- **Acoustic Echo Canceller**
 - Full-duplex operation during double-talk situations
 - One channel AEC, one channel LEC up to 256ms shared
 - Cancels echoes with up to 10dB echo return
 - Advanced noise reduction(up to 20dB)
- **Speaker**
 - Impedance : 8 +-15%ohm at 1kHz, 1.0 Vrms
 - Sound Pressure : 90 +- 3dB at 0.1W/10 CM
at 800Hz, 1.0kHz, 1.2kHz, 1.5kHz
 - Resonance Level : 550Hz +- 20%Hz at Fo Hz, 1.0Vrms
 - Frequency Range : Fo Hz ~20kHz
 - Input Power : Normal : 1.0 W, Max : 2.0W
- **Audio Amplifier**
 - 1-W BTL Output(5V, 0.11 % THD+N)
 - Uncompensated Gains of 2 to 20 (BTL Mode)
 - Thermal and Shot-circuit Protection
 - High Supply Ripple Rejection Ratio
- **PoE(Power over Ethernet)**
 - IEEE802.3af compliant
 - Input voltage range 36V to 57V
 - Short-circuit Protection



Hardware Specification

AP-VAC70 IP HD Video Door Phone

RISC
CPU

High-end
DSP

- **LCD Controller**
 - One-Chip Solution for amorphous TFT-LCD
 - Support resolution up to 240xRGBx320
 - Built-in 172800 bytes internal RAM
 - 6,8,16, and 18-bit RGB Interface
 - Resize Function (x ½, x ¼)
 - On-Chip Power Management System
- **HD Video Camera**
 - CMOS 720P Wide Dynamic Range(WDR) HD Image Sensor
 - Output Formats : YUV, separated and combined RAW
 - Image Size : WXGA(1280x480), HD 720P(1280x720), WVGA(752x480),
VGA(640x480), CIF(352x288), QVGA(320x240)
 - 1/3 Inch One(1) Megapixel Image Sensor
 - Automatic Exposure/Gain
 - Horizontal and Vertical Windowing Capability
 - Auto White Balance Control
 - Aperture/Gamma Correction
 - 50/60Hz Flicker Cancellation
 - Defective Pixel Correction

Hardware Specification

AP-VAC70 IP HD Video Door Phone

RISC
CPU

High-end
DSP

- RF Card Sensor
 - Protocol Supported
 - ISO14443A/B all bit rates
 - > 106,212,424 and 848 kbps
 - Compatible to MiFare Classic
 - ISO15693 all modes
 - > 1.65/6.6 & 26.5 kbps
 - > Uplink 1 & 2 sub-carrier
 - Receiver
 - Rx Sensitivity down to 1mVrms
 - Rx Automatic Gain Control
 - Accept external baseband signal from external circuitry for frame level processing
 - Integrated signal strength indicator (SSI)
 - On-Chip Framing handler for supported standard
 - Transmitter
 - Typical proximity operating distance up to 100mm.
 - Software configurable modulation index
 - Maximum driving current up to 200 mA/PIN @ 5V
 - Accept external baseband signal for RF modulation
 - Wide Transmitter driver supply range from 2.7~7.0V



RF Card Sensor

Hardware Specification

AP-VAC70 IP HD Video Door Phone

RISC
CPU

High-end
DSP

Front Side

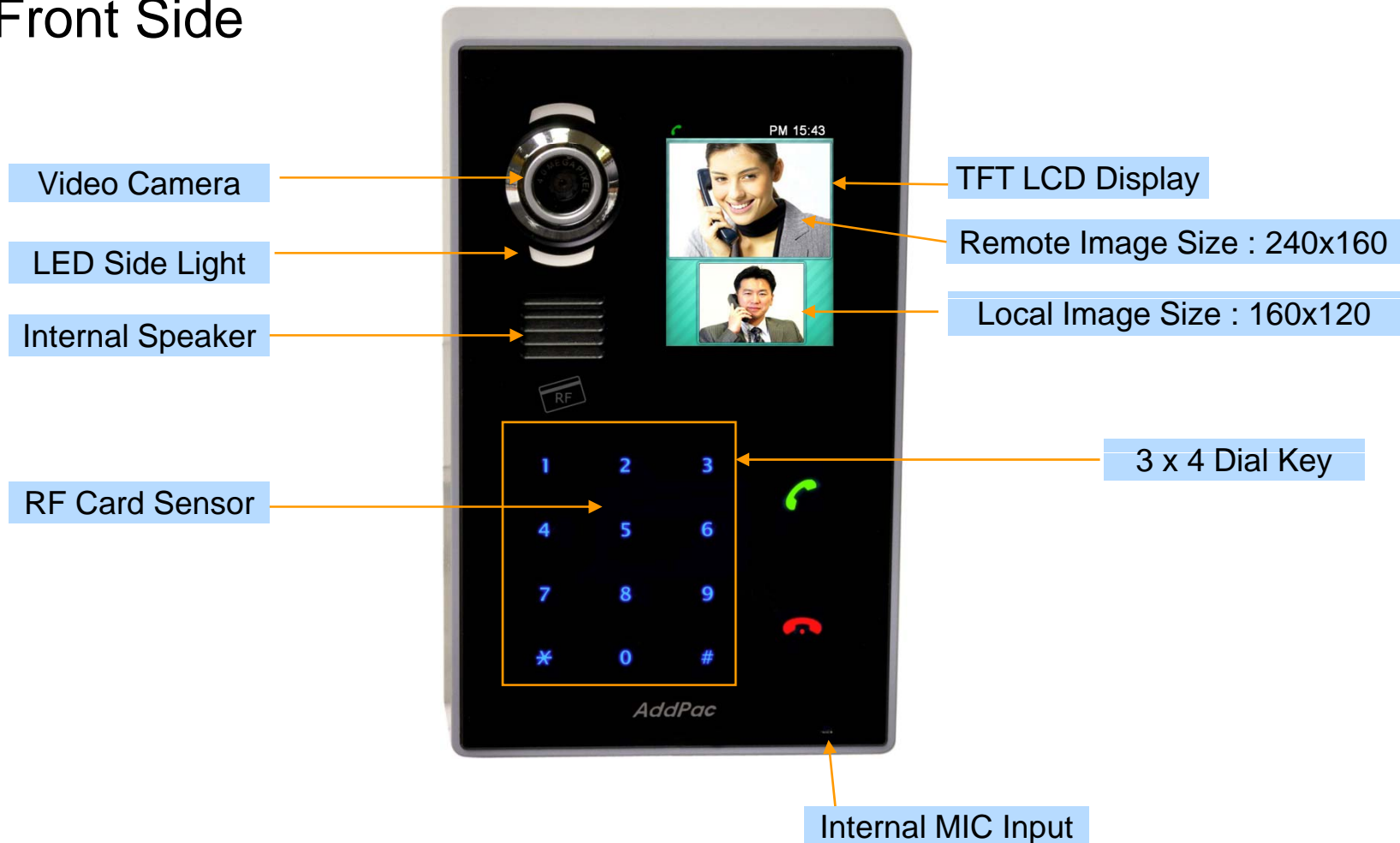

Hardware Specification

AP-VAC70 IP HD Video Door Phone

RISC
CPU

High-end
DSP

Back Side

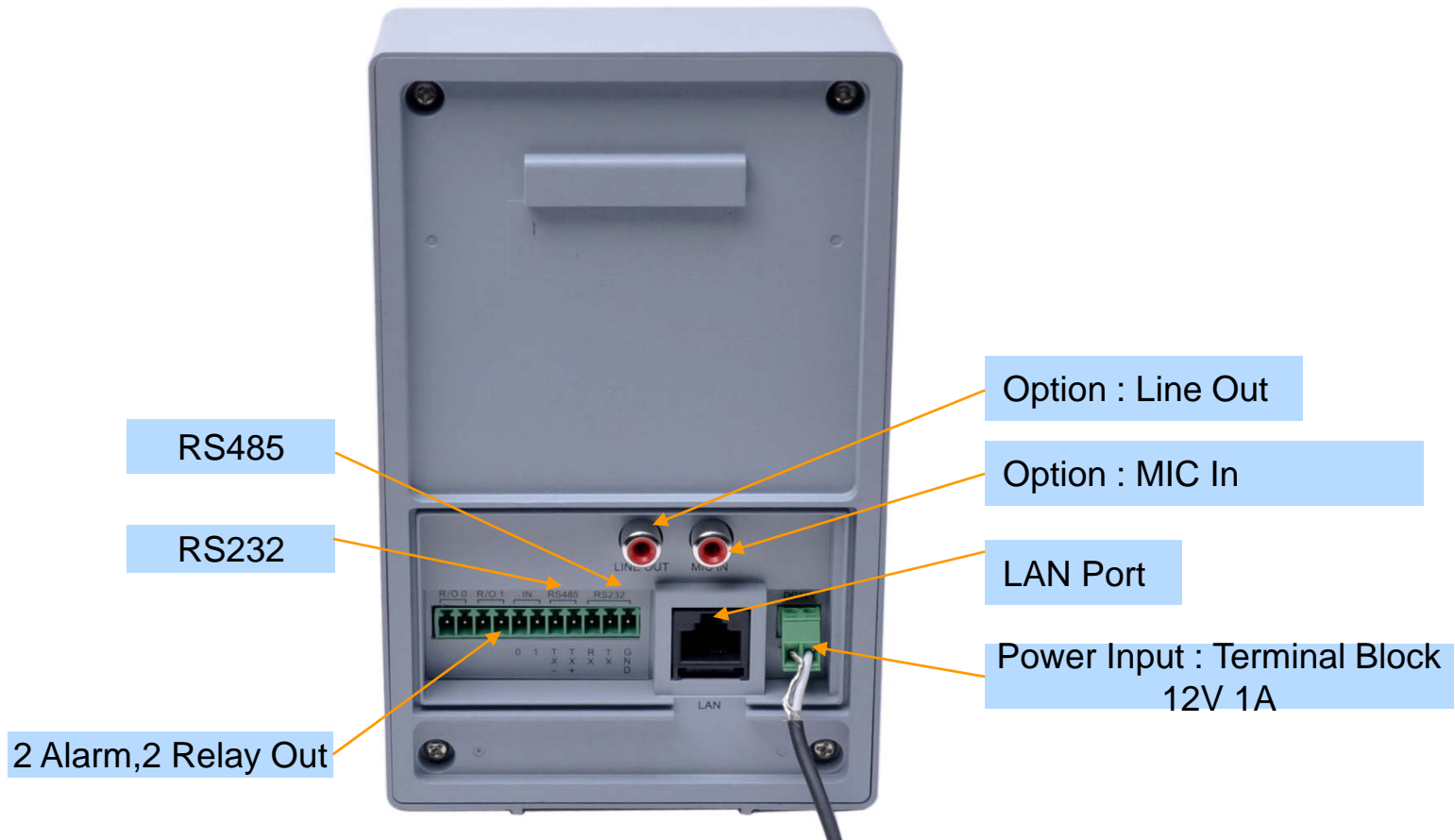

Hardware Specification

AP-VAC70 IP HD Video Door Phone

RISC
CPU

High-end
DSP

Back Side



Wall Mount Bracket

Rubber Cover for light waterproof



AP-VAC50 IP Video Door Phone

Main Features

AP-VAC50 IP Video Door Phone

- High Performance IP Video Door Phone Solution
- Video Camera, 3x4 Key, TFT Color LCD, Internal MIC & Speaker
- H.323/SIP Concurrent VoIP Signaling Stack Embedded
- RF Card Interface
- High-performance Video/Voice Codec Support
 - H.264/MPEG4, G.711, etc
- One(1) 10/100Mbps Fast Ethernet
- PoE(Power over Ethernet) Support
- High Quality Speaker Phone Features
- Powerful Acoustic Echo Canceller
- Powerful Network Protocols (PPPoE, DHCP, Static Routing, etc)
- Firmware Upgradeable Architecture
- Advanced Voice QoS Mechanism



Hardware Specification

AP-VAC50 IP Video Door Phone

RISC
CPU

High-end
DSP

- RISC+DSP Microprocessor Computing Power (Dual Processor Architecture)
- Audio and Voice Interface
 - Internal MIC
 - Internal Speaker
 - 3 x 4 key PAD
- Video Camera Interface
- 2 Inch TFT Color LCD Interface
- RF Card Interface
- Network Interface
 - One(1) 10/100Mbps Fast Ethernet
- Alarm & Relay Out Interface (door open, etc)
- RS232/RS422/RS485 Interface
- Power Supply
 - Power over Ethernet (Option)

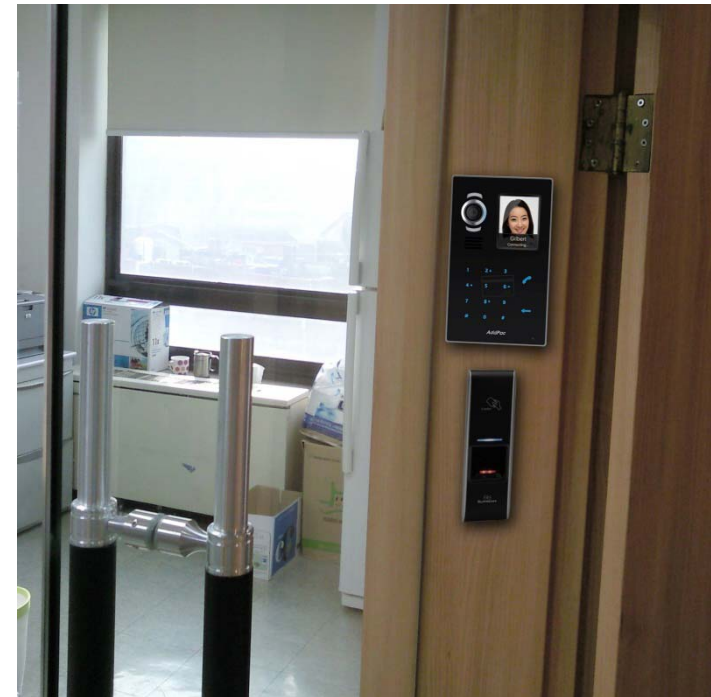

Hardware Specification

AP-VAC50 IP Video Door Phone

RISC
CPU

High-end
DSP

Front Side

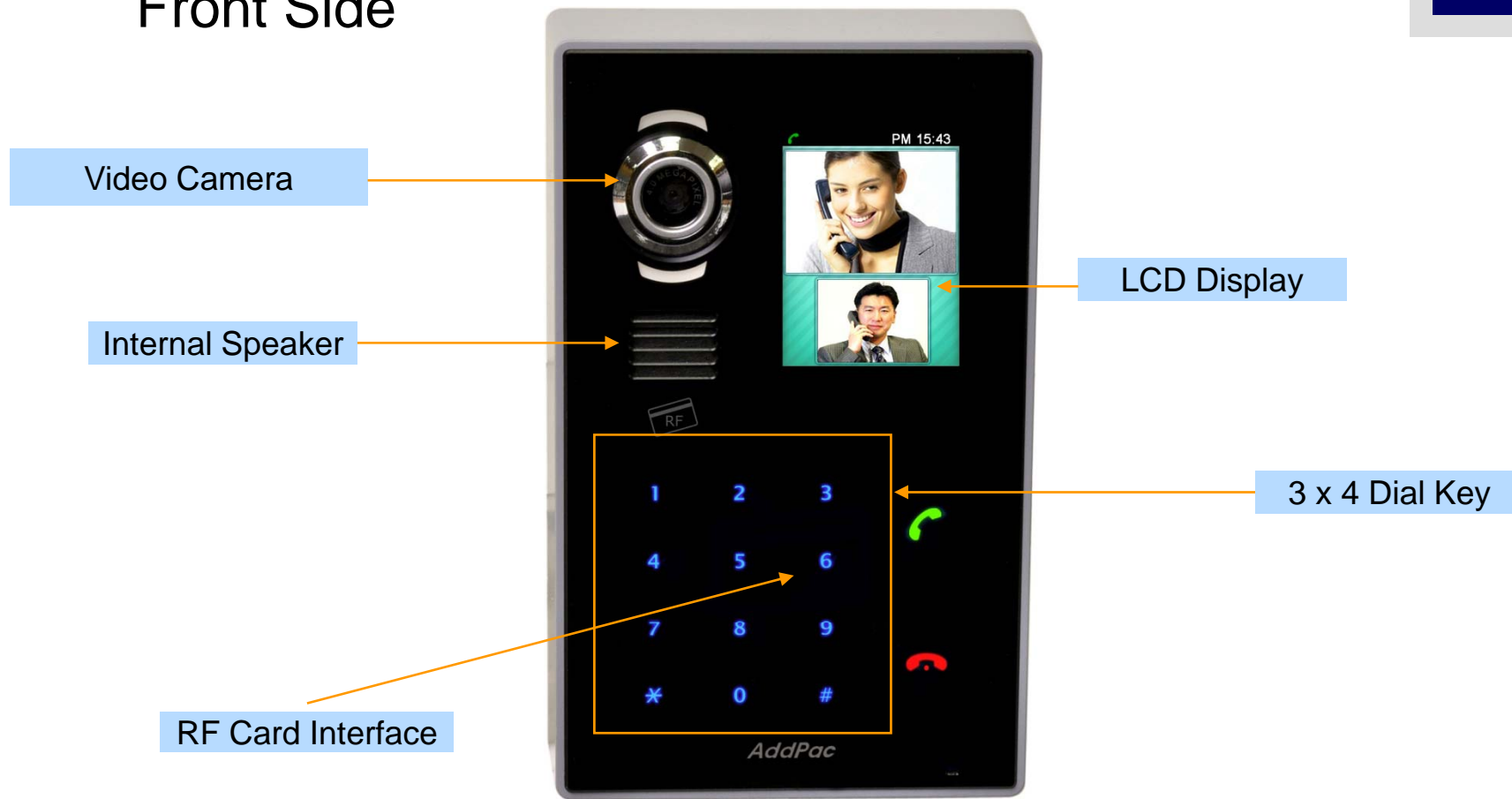

Hardware Specification

AP-VAC50 IP Video Door Phone

RISC
CPU

High-end
DSP

Back Side

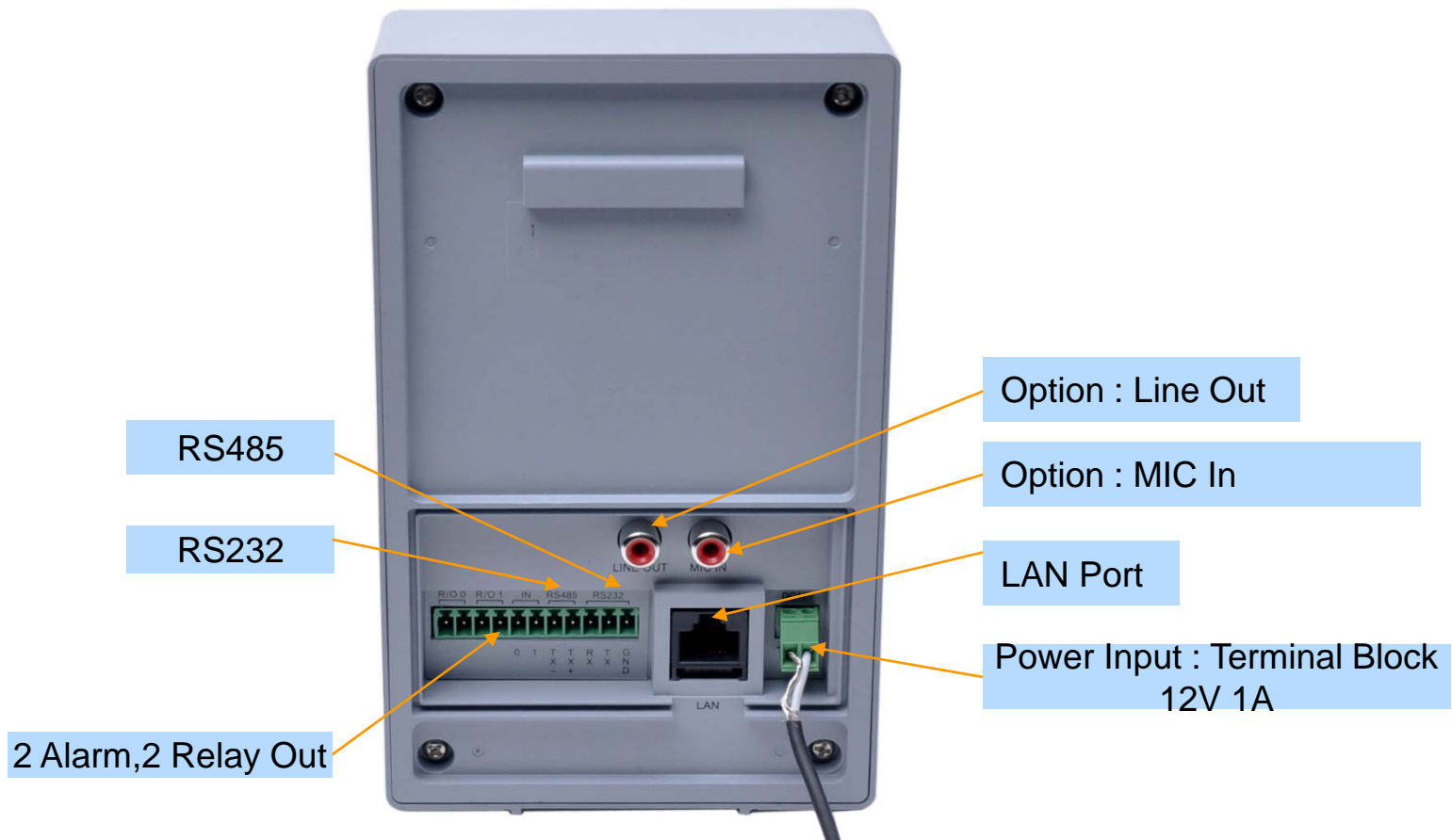

Hardware Specification

AP-VAC50 IP Video Door Phone

RISC
CPU

High-end
DSP

Back Side

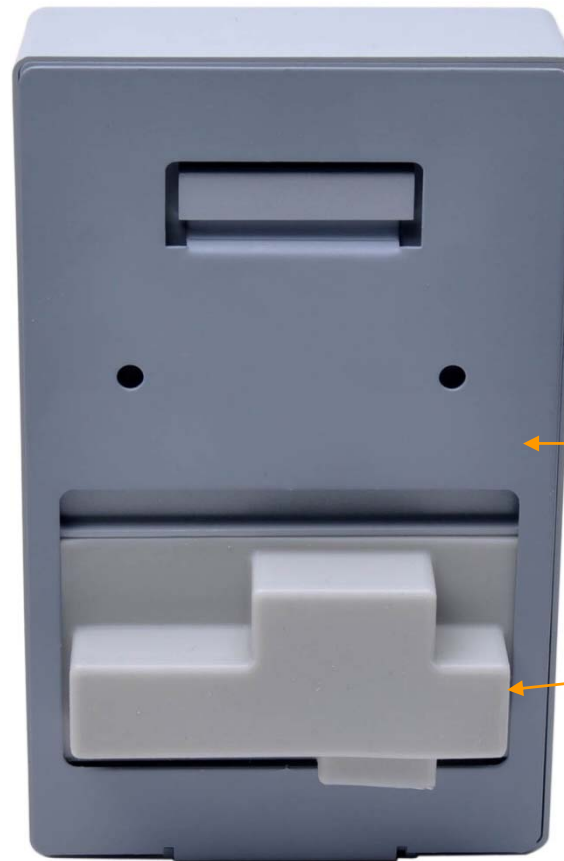

Wall Mount Bracket

Rubber Cover for light waterproof



AP-VAC20 IP Video Door Phone

Main Features

AP-VAC20 IP Video Door Phone

- High Performance IP Video Door Phone Solution
- Video Camera, 3x4 Key, LCD, Internal MIC & Speaker
- H.323/SIP Concurrent VoIP Signaling Stack Embedded
- RF Card Interface
- High-performance Video/Voice Codec Support
 - H.264/MPEG4, G.711, etc
- One(1) 10/100Mbps Fast Ethernet
- PoE(Power over Ethernet) Support
- High Quality Speaker Phone Features
- Powerful Acoustic Echo Canceller
- Powerful Network Protocols (PPPoE, DHCP, Static Routing, etc)
- Firmware Upgradeable Architecture
- Advanced Voice QoS Mechanism

Hardware Specification

AP-VAC20 IP Video Door Phone

RISC
CPU

High-end
DSP

- RISC+DSP Microprocessor Computing Power (Dual Processor Architecture)
- Audio and Voice Interface
 - Internal MIC
 - Internal Speaker
 - 3 x 4 key PAD
- Video Camera Interface
- RF Card Interface
- Graphic LCD Interface
- Network Interface
 - One(1) 10/100Mbps Fast Ethernet
- Alarm & Relay Out Interface (door open, etc)
- RS232/RS422/RS485 Interface
- Power Supply
 - Power over Ethernet (Option)
 - External Power Supply



Hardware Specification

AP-VAC20 IP Video Door Phone

RISC
CPU

High-end
DSP

Front Side

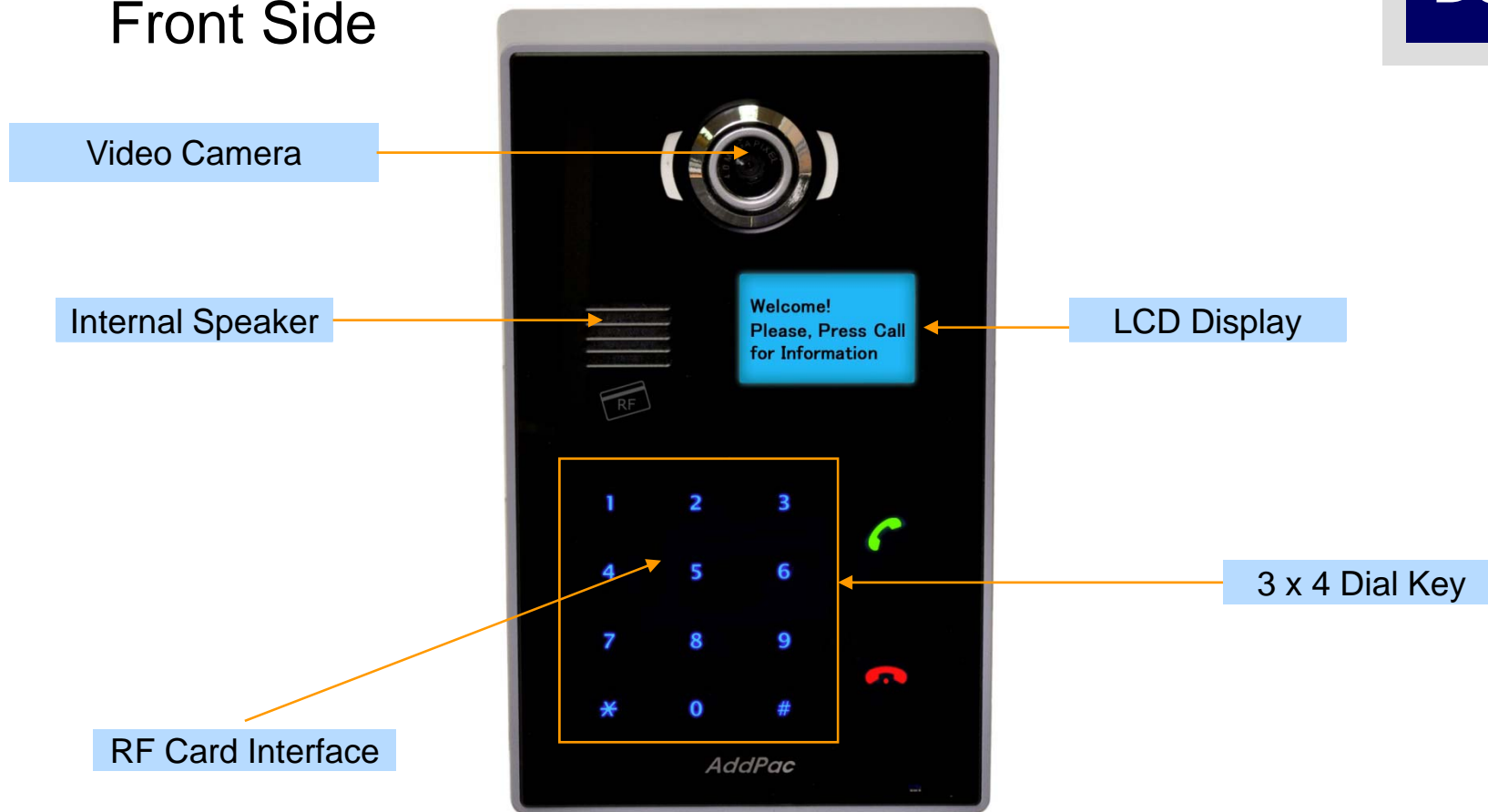



Thank you!

AddPac Technology Co., Ltd.
Sales and Marketing

Phone +82.2.568.3848 (KOREA)

FAX +82.2.568.3847 (KOREA)

E-mail : sales@addpac.com