

# GSM/CDMA Gateways

GSM/CDMA Concurrent Service  
(ex: AP-GS1500)



**AddPac**

**AddPac Technology**

2011, Sales and Marketing

[www.addpac.com](http://www.addpac.com)

# Contents

- GSM/CDMA Interworking Network Diagram
- GSM/CDMA VoIP Interface Network Diagram
- GSM/CDMA Gateway Comparison Table
- GSM/CDMA Interface Module
- AP-GS1500 Hardware Platform
- AP-GS1500 Platform Module Combination Examples

# GSM/CDMA Interworking Network Diagram



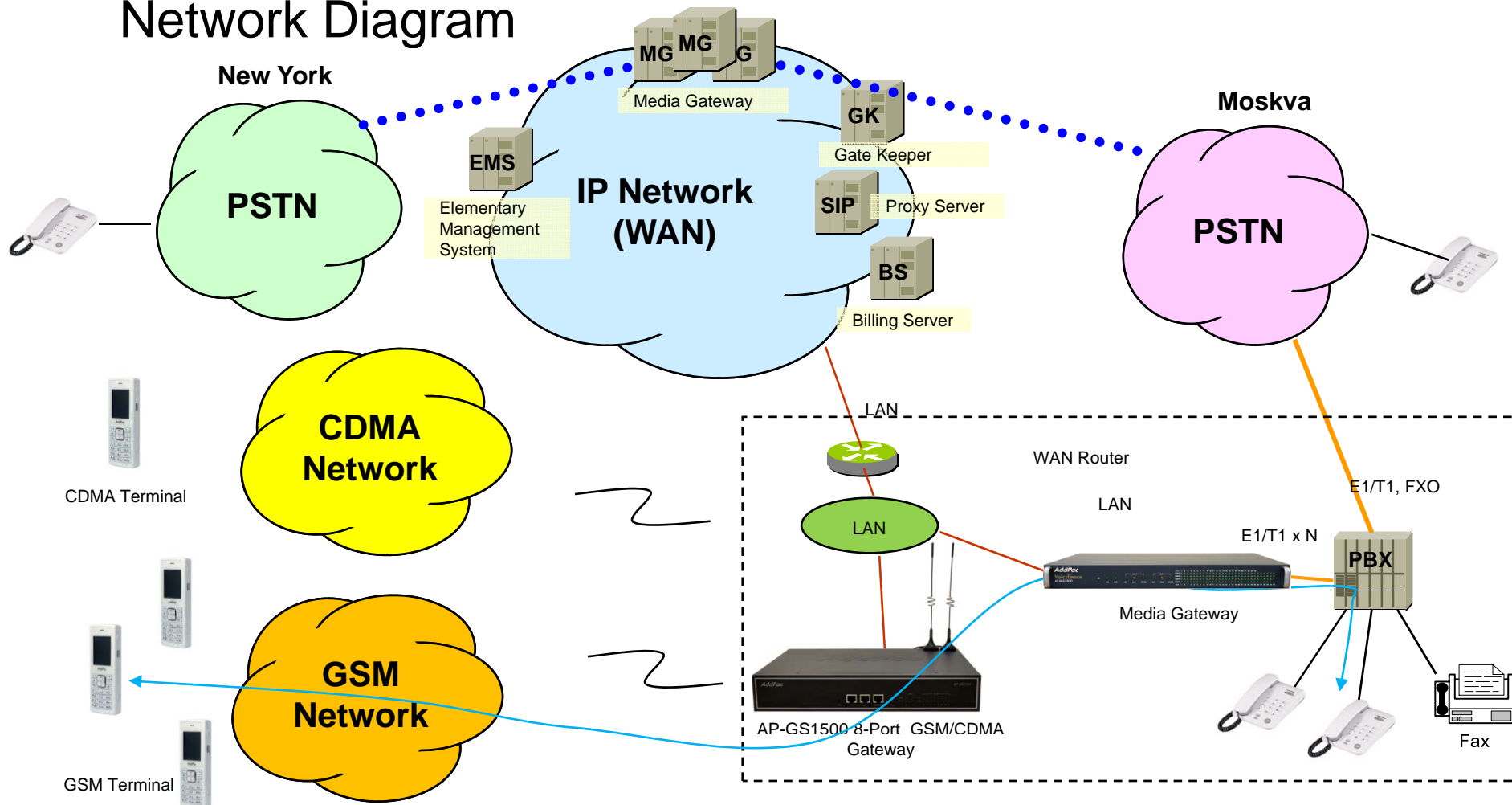

## Network Diagram

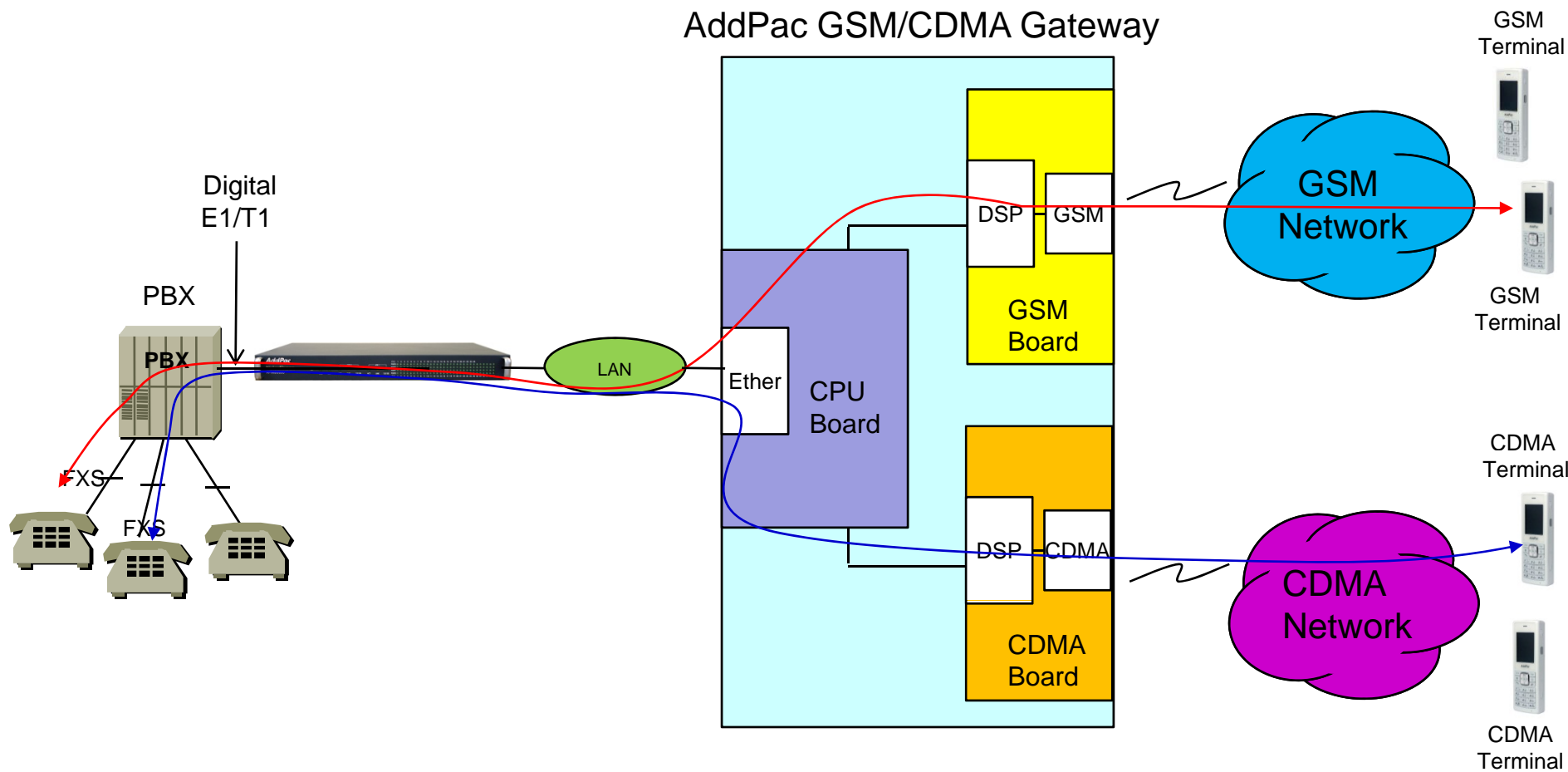

# GSM/CDMA VoIP Interface Network Diagram



# GSM/CDMA Gateway Comparison Table

Model	AP-GS1500	AP-GS2000	AP-GS2500	AP-GS3000	AP-GS3500
					
Available Modules	AP-N1-GSM4 <b>AP-N1-CDMA4</b> AP-N1-FXS8 AP-N1-FXO8 AP-N1-FXS4O4	AP-N1-GSM4 <b>AP-N1-CDMA4</b> AP-N1-FXS8 AP-N1-FXO8 AP-N1-FXS4O4 AP-N1-E1	AP-N1-GSM4 <b>AP-N1-CDMA4</b> AP-N1-FXS8 AP-N1-FXO8 AP-N1-FXS4O4 <b>AP-N1-E1</b>	AP-N1-GSM4 <b>AP-N1-CDMA4</b> AP-N1-FXS8 AP-N1-FXO8 AP-N1-FXS4O4 <b>AP-N1-E1</b>	AP-N1-GSM4 <b>AP-N1-CDMA4</b> AP-N1-FXS8 AP-N1-FXO8 AP-N1-FXS4O4 <b>AP-N1-E1</b>
GSM/CDMA Channel	Up to 8 Channel	Up to 12 Channel	Up to 16 Channel	Up to 36 Channel	Up to 36 Channel
Antenna	One(1) / 4 Channel GSM Module (AP-N1-GSM4)	One(1) / 4 Channel GSM Module (AP-N1-GSM4)	One(1) / 4 Channel GSM Module (AP-N1-GSM4)	One(1) / 4 Channel GSM Module (AP-N1-GSM4)	One(1) / 4 Channel GSM Module (AP-N1-GSM4)
Module Slot	Two(2) Module Slots for GSM	Three(3) Module Slots for GSM	Four(4) Module Slots for GSM	Nine(9) Module Slots for GSM, E1/T1 Module Slot	Nine(9) Module Slots for GSM, E1/T1 Module Slot
LAN Port	2	2	2	2	2
Console	1	1	1	1	1
Power	Single PSU	Single PSU	Single PSU	Single PSU	Dual PSU(module)

# GSM/CDMA Interface Module

**AP-N1-GSM4** 4-Port GSM Module



**AP-N1-CDMA4** 4-Port CDMA Module



# AP-GS1500 Hardware Platform

RISC  
CPU

High-end  
DSP

## Back Side View

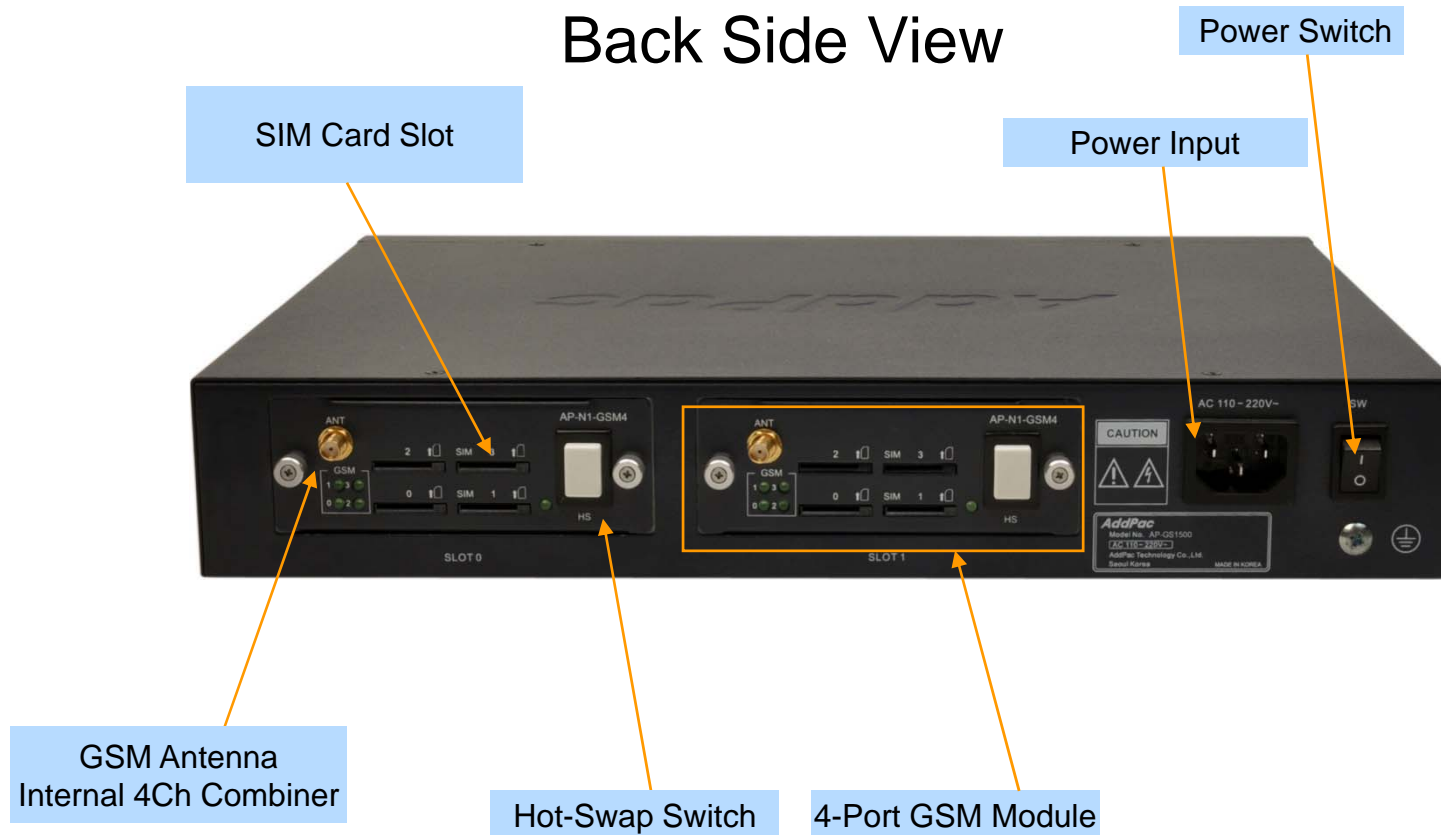

# AP-GS1500 Platform Module Combination Examples

High-end  
**DSP**

2 x AP-N1-GSM4 Module = 8-  
Port GSM Channel



2 x AP-N1-CDMA4 Module = 8-  
Port CDMA Channel



1 x AP-N1-GSM4 Module + 1 x  
AP-N1-CDMA4 Module = 4-Port  
GSM Channel + 4-Port CDMA  
Channel





# GSM/CDMA Gateway Series

# Thank you!

**AddPac Technology Co., Ltd.**  
Sales and Marketing

Phone +82.2.568.3848 (KOREA)

FAX +82.2.568.3847 (KOREA)

E-mail [sales@addpac.com](mailto:sales@addpac.com)