

Dynamic IP Address Support for GSM SIM Server Interworking

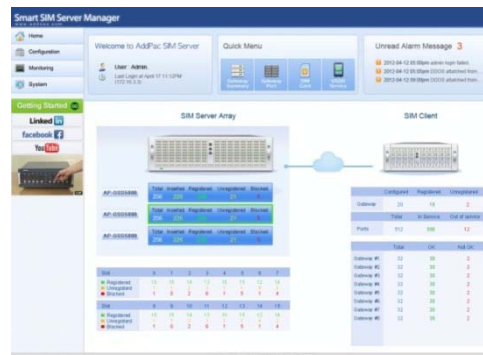

AddPac

AddPac Technology

Sales and Marketing

Contents

- General GSM SIM Server Service Diagram
- Network Issues for Remote SIM Application
- Dynamic IP Address Network Environment
- Detailed Network Configuration
- Remote SIM Service Procedure
- Technical Remote SIM Service Issues
- Local IP Address Change Recognition

General GSM SIM Server Service Diagram

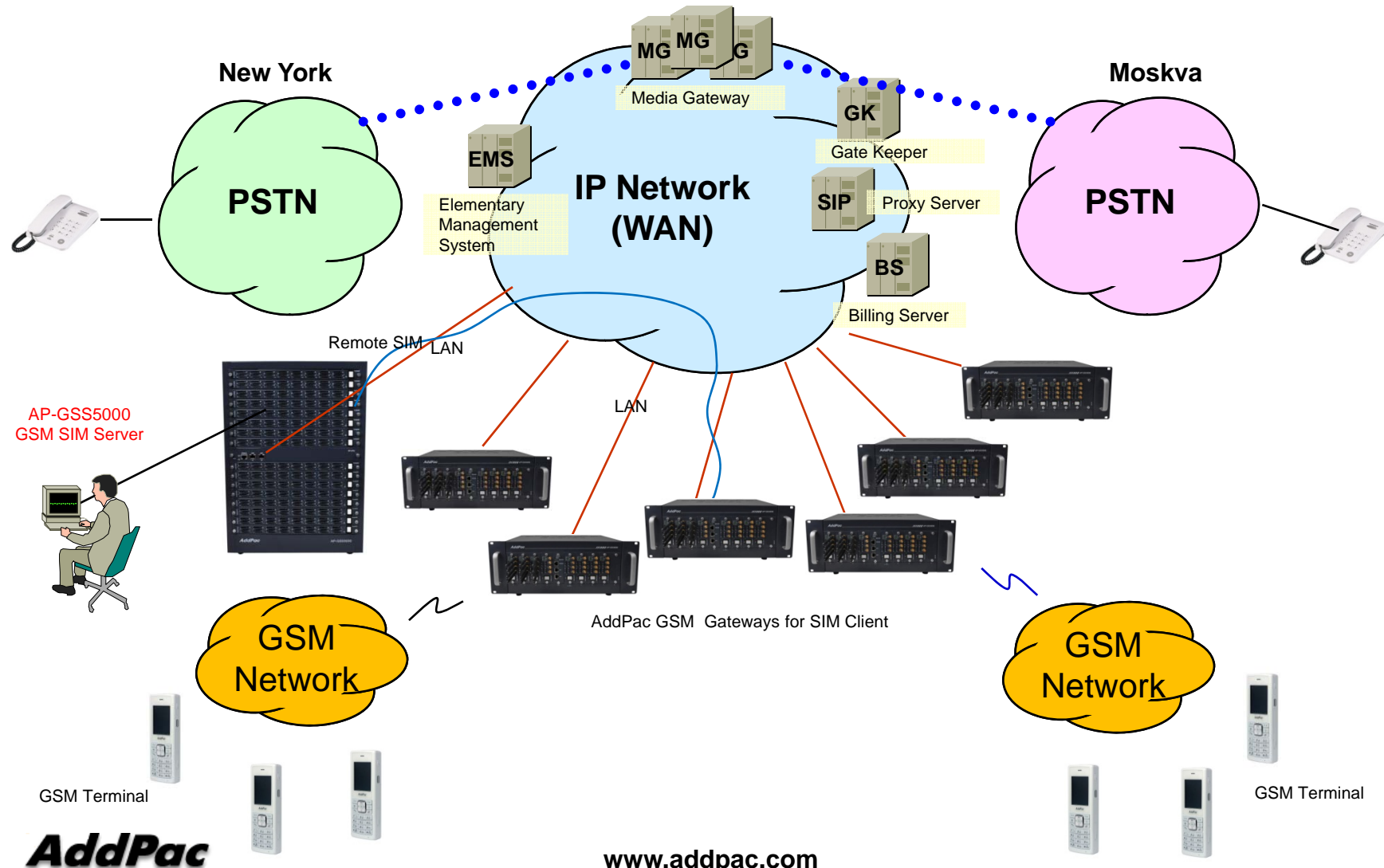



Dynamic IP Address Support

Overall Network Issues for Remote SIM App.

- IP Address Environment
 - IP Address Insufficient Problem -> Dynamic IP Address
 - Fixed IP Address is very expensive (Ex : Leased Line)
 - Remote SIM Server Side (Dynamic IP Address) : use the xDSL Modem
 - SIM Client Side (Dynamic IP Address) : use the xDSL or Wireless Modem
- Access Network Environment for SIM Client
 - 3G Data, WiMAX, etc Wireless Modem
 - “GSM VoIP Service + SIM Data Exchange” is occurred concurrently
 - Characteristic : High Delay, Frequent Packet Loss,
Frequent Packet Sequence Change,
Best Effort QoS,
Abrupt IP Address Change,
Unstable Power Supply
 - High Performance & Reliable Data Link Protocol must be used

Dynamic IP Address Environment (SIM Client : Wired Access Network)

Dynamic DNS

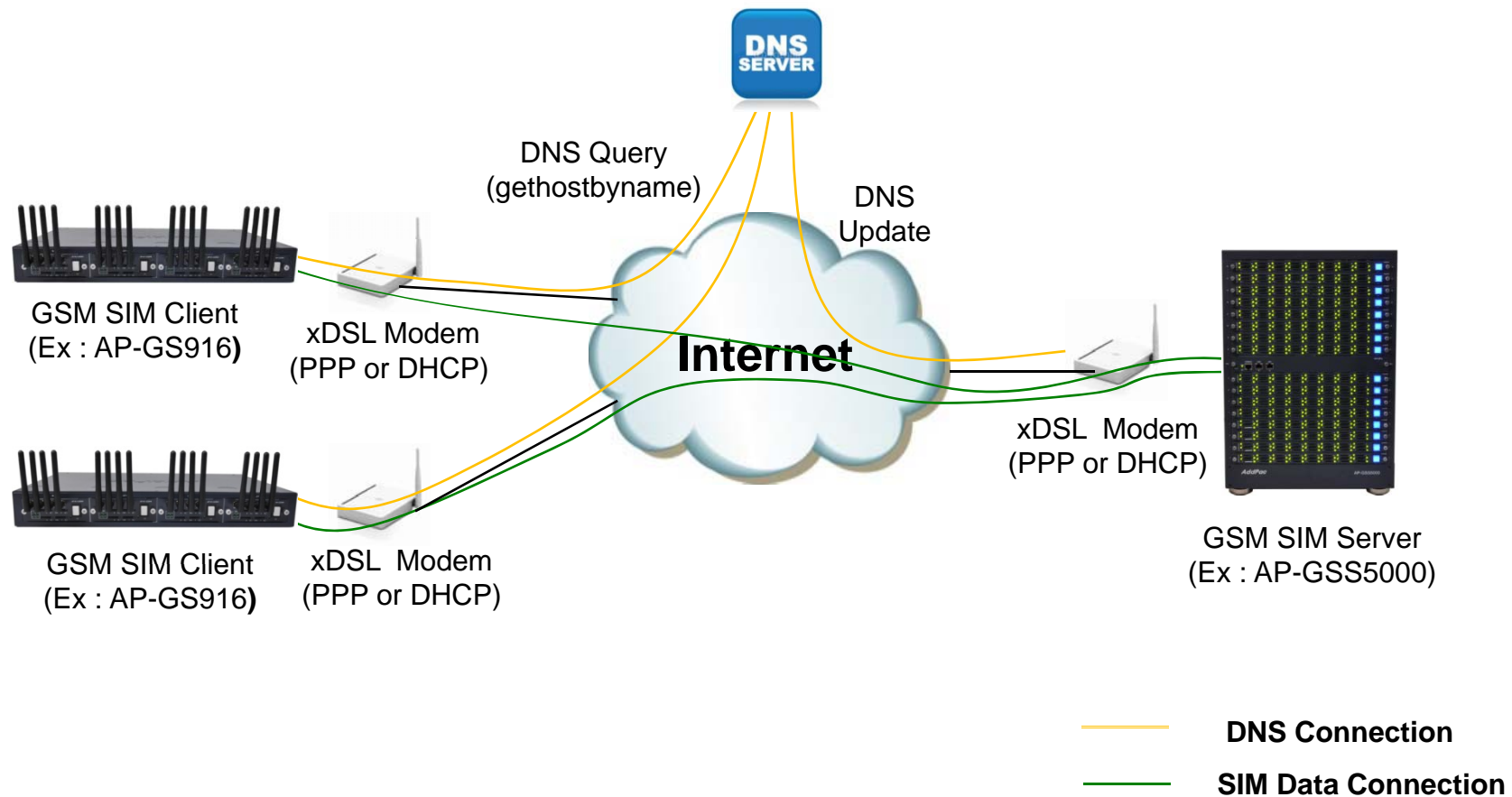

Dynamic IP Address Environment (SIM Client : Wireless Access Network)

Dynamic DNS

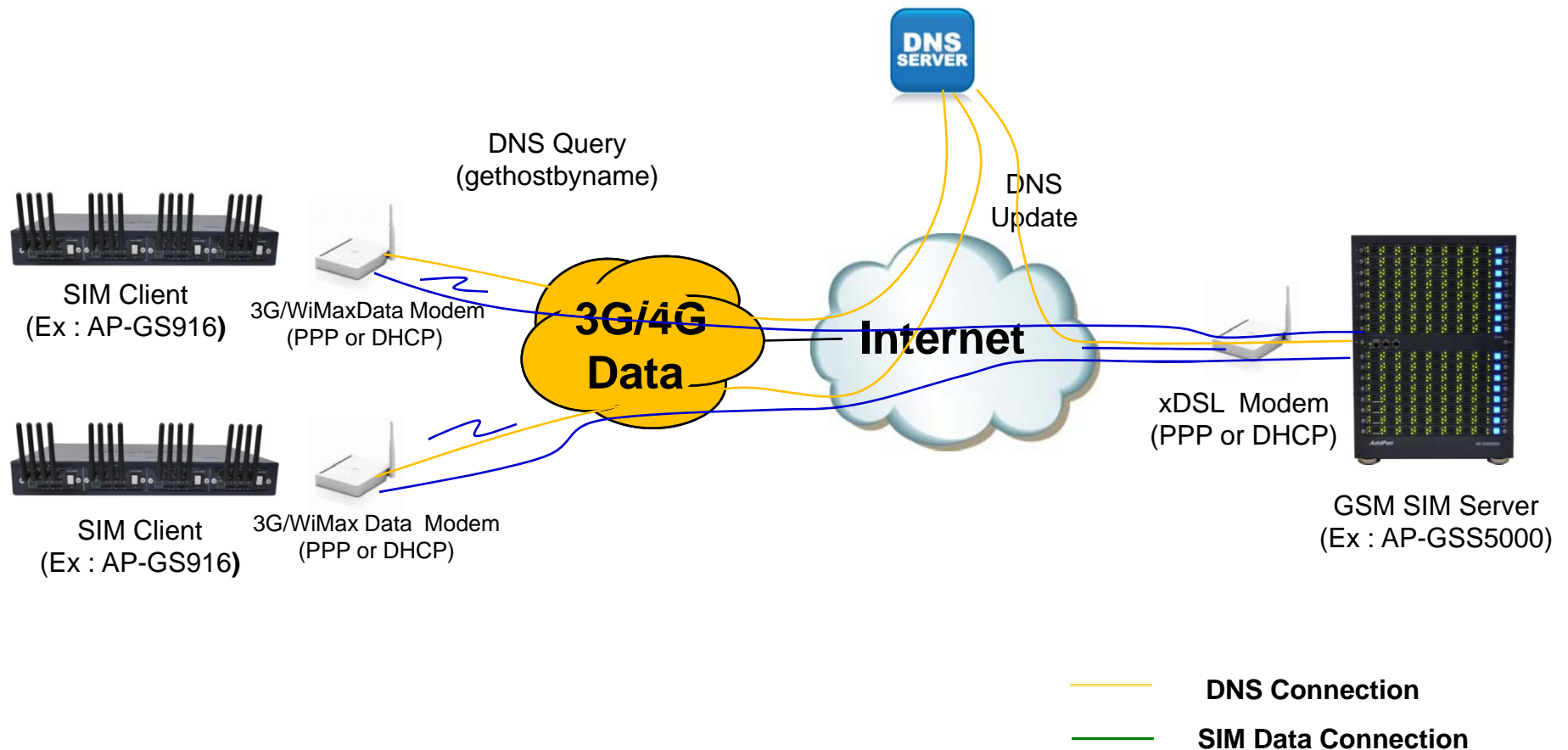

Network Configuration Detail (1/2)

- With NAT Router Mode

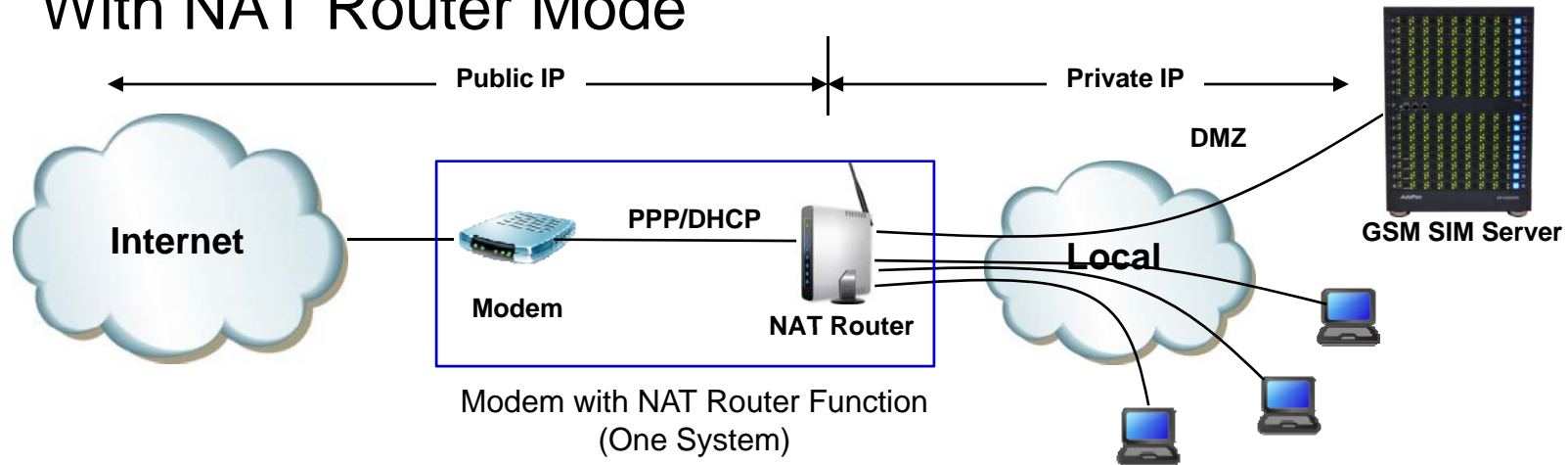

- Without NAT Router Mode

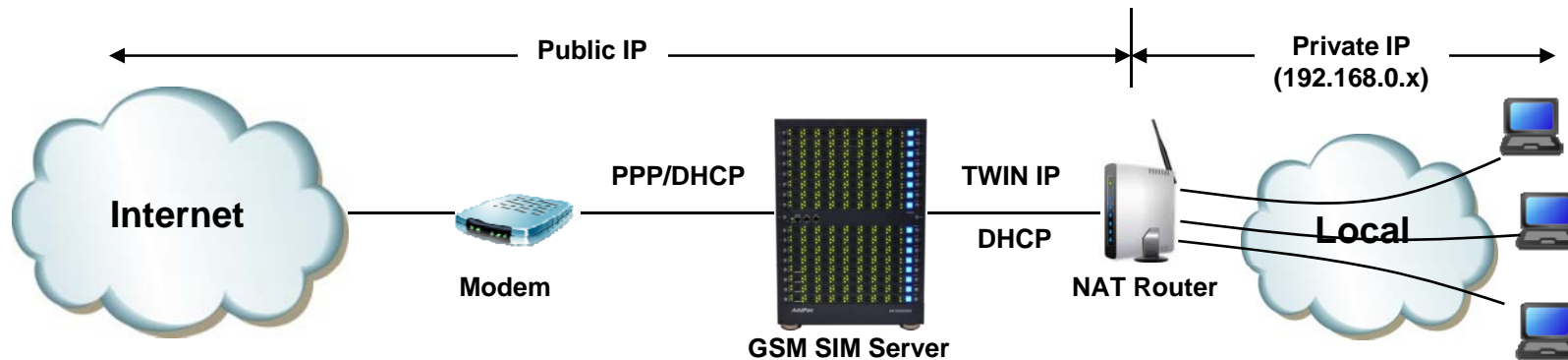

Network Configuration Detail (2/2)

- With NAT Router Mode
 - NAT Router is Public Address
 - SIM Server/Client is Private Address (Static Address)
 - Set DMZ for SIM Server/Client (or Port forwarding)
 - NAT Router Role
 - Recognition Local Address Change and
 - Dynamic DNS update (for SIM Server Connection)
- Without NAT Router Mode (*Recommend*)
 - SIM Server/Client is Public Address (PPP, DHCP or Static)
 - NAT Router is connected with FastEthernet0/1 via DHCP(optional)
 - Use IP-Connect mode for NAT router (TWIN IP, Public IP Relay)
 - SIM Server/Client Role
 - Recognition Local Address Change and
 - Dynamic DNS update (SIM Server only)

Remote SIM Service Procedure

- GSM SIM Sever
 - Get Network IP Address (Public or Private address)
 - Update Dynamic DNS information (SIM Server or Modem)
 - Wait SIM Client Connection
 - Data Exchange with Client
- GSM SIM Client (Ex : GSM VoIP Gateway)
 - Get Network IP Address (Public or Private address)
 - Get SIM Server Public Address using DNS Query (gethostbyname)
 - Connection with SIM Server
 - Data Exchange with Server

Technical Remote SIM Service Issues

- GSM SIM Server Side
 - Fast Recognition for Network Address Change
 - Notify Local Address Change
 - Maintain SIM Client Connection when Local or Peer Address is changed
- GSM SIM Client Side (Ex:GSM VoIP Gateway)
 - Setup SIM Server Address using Domain-name not IP address
 - Fast Recognition for Network Address Change
 - Notify Local Address Change
 - Fast Recognition for Server Address Change

SIM Service Connection (1/2)

GSM SIM Client



GSM SIM Server

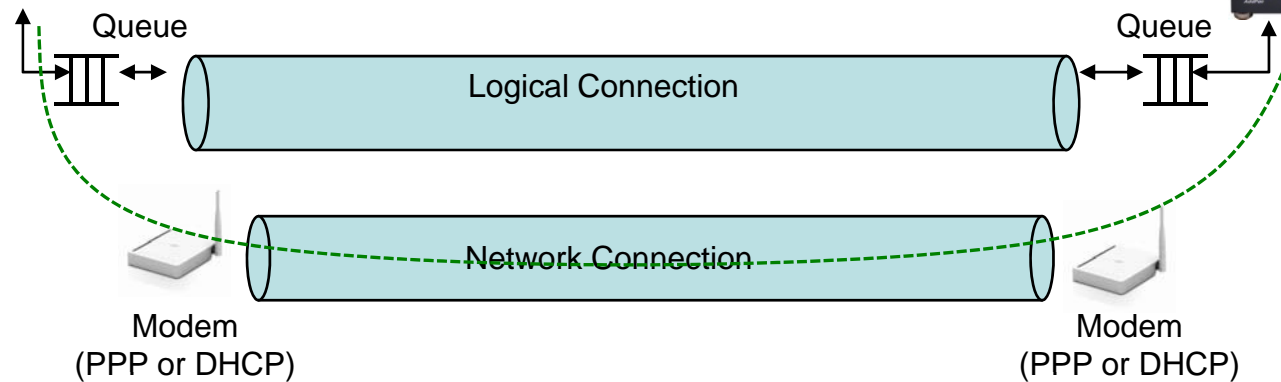

----- Physical Connection

SIM Service Connection (2/2)

- Logical Connection
 - Establish Logical Connection
 - Transmit and Receive User SIM Data
 - Logical Connection Keep Alive (Detect Logical Link Down)
 - Flow Control, Retransmit (Selective Retransmission)
- Network Connection
 - Establish Network Connection
 - Transmit and Receive Logical Connection Data
 - Monitoring Local Address Change
 - Update Dynamic DNS Server (SIM Server only)
 - Notify Address Change using Logical Link Keep Alive Message
 - Monitoring SIM Server Address Change (SIM Client only)
 - Adjust DNS Query interval
 - Send DNS Query Immediately, when No Response received for Logical Connection Keep Alive

Local IP Address Change Recognition

- **PPP/PPPoE**
 - Using LCP Echo Request
 - Send LCP Echo Request packet for given interval and time
 - For Fast Detection, Reduce the value
 - No Response, LCP Link Down and Restart PPP Session
 - Using ICMP Echo Request : (described below)
- **DHCP**
 - Reduce DHCP Lease Time if possible (manual configuration)
 - Using ICMP Echo Request
 - Send ICMP Echo Request(PING) Packet to default router for given interval and time
 - No Response, Send DHCP RELEASE and DISCOVER Packet
 - Reduce DHCP DISCOVER packet interval for Fast Reconnection



Thank you!

AddPac Technology Co., Ltd.
Sales and Marketing

Phone +82.2.568.3848 (KOREA)

FAX +82.2.568.3847 (KOREA)

E-mail sales@addpac.com