

Error Robust HD Video Codec Solution



Error Robust HD video Codec Solution

- AP-NC5000 HD Video Codec
- AP-NC3500 HD Video Codec
- AP-NC3000 HD Video Codec
- AP-NC2000 HD Video Codec
- AP-NC2000D HD Video Codec

[Learn More >](#)

The advertisement features a blue background with a central image of a computer monitor displaying a scene of three ships on the ocean. To the right of the monitor is a rack-mounted video codec device. Below the monitor and to the left of the rack device is a printed circuit board (PCB) with various components.

Error Robust H.264 Temporal Domain
SVC(scalable video coding) Support

AddPac

AddPac Technology

Sales and Marketing



www.addpac.com

Contents

- Error Robust HD Video Transmission Service Diagram
- Error Robust HD Network DVR Service Diagram
- HD Video Codec Platform
 - AP-NC5000 Ten(10) Video Module Slots
 - AP-NC3500 Four(4) Video Module Slots
 - AP-NC3000 Two(2) Video Module Slots
 - AP-NC2000 One(1) Video Module Slots(Internal Power Supply)
 - AP-NC2000D One(1) Video Module Slots(External Power Supply)
- Error Robust Video Module for HD Video Codec Platform
 - AV6000N Error Robust Full HD Video Encoder/Decoder Module

Error Robust HD Video Transmission (Point-to-Point Connection)

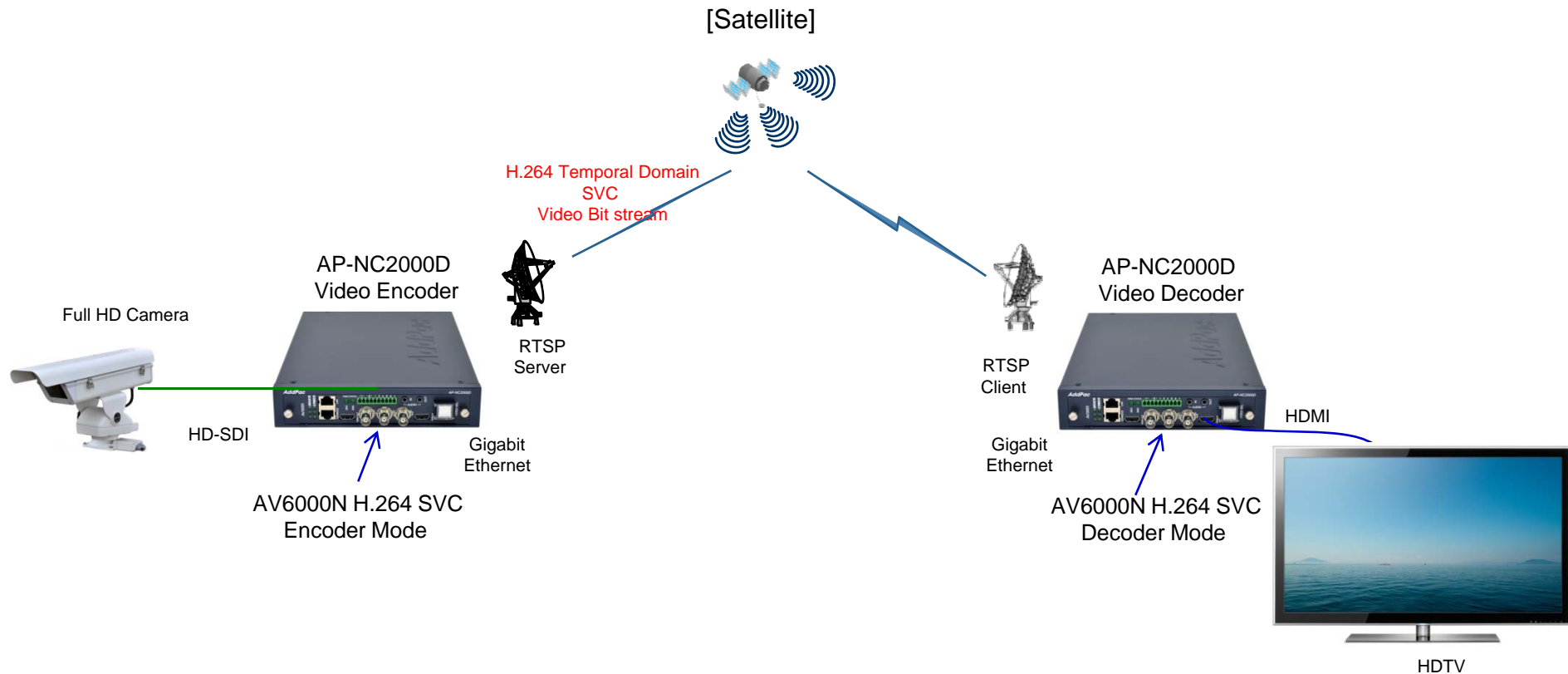

Error Robust HD Video Transmission (Point-to-Multi-Point Connection)

Satellite based Video Monitoring

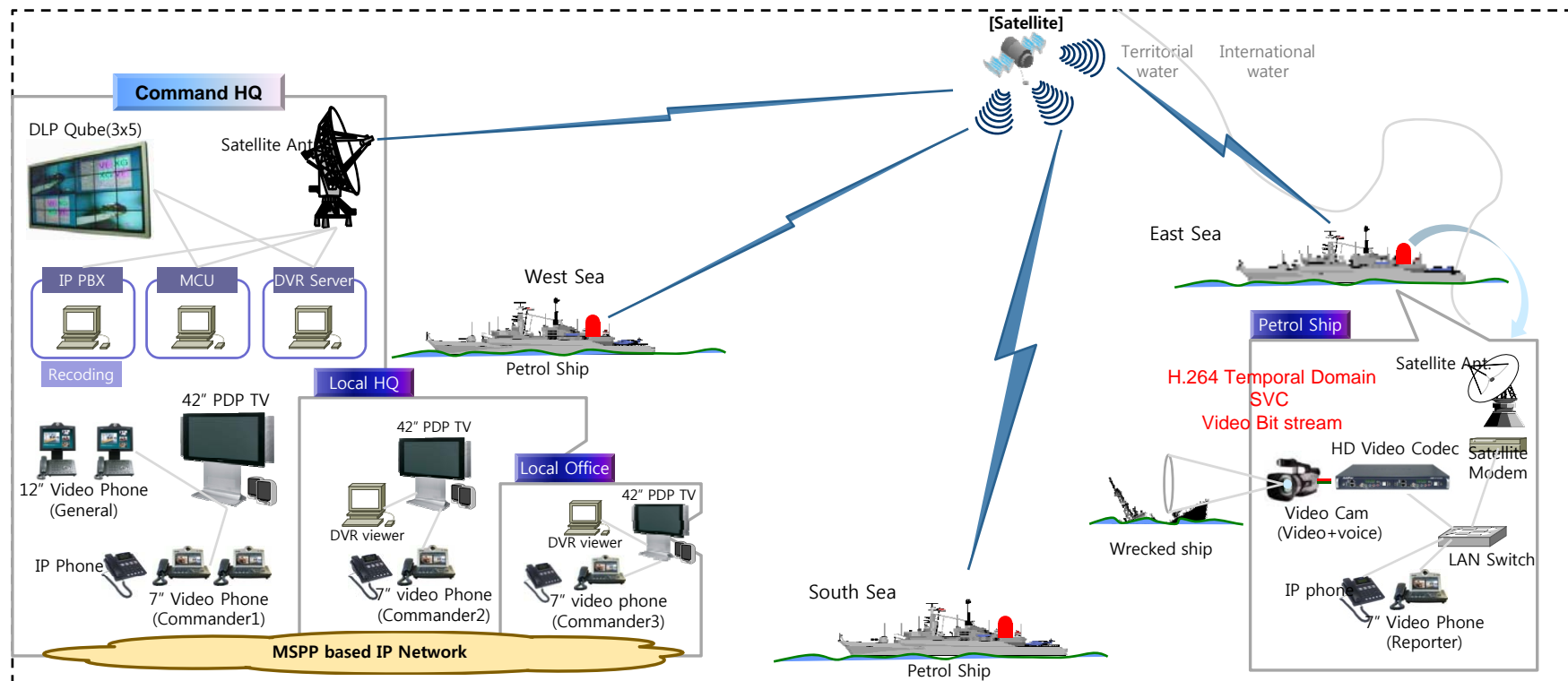

HD Network DVR Service Diagram

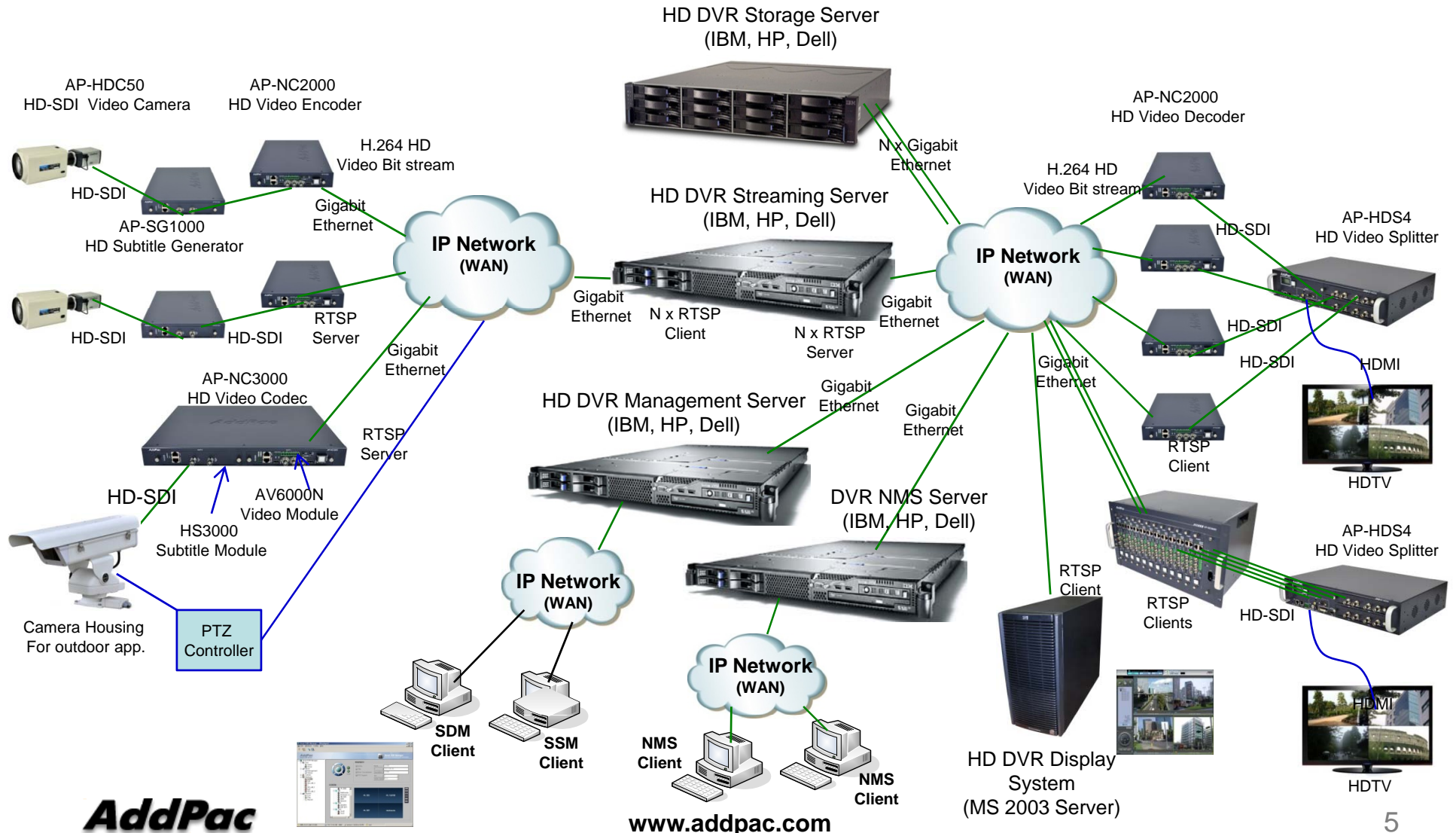





AddPac

www.addpac.com



HD Video Codec Platform

HD Video Codec Platform Comparison Table

	AP-NC2000D	AP-NC2000	AP-NC3000	AP-NC3500	AP-NC5000
Model					
Module Slot	1 Module Slot	1 Module Slot	2 Module Slots	4 Module Slots	10 Module Slots
Power Supply	External Power Supply(DC)	Internal Power Module (AC)	Internal Power Module (AC)	Internal Power Module (AC)	Internal Power Module (AC)
Power Type	Power Adaptor	Built-In	Built-In	Module Type	Module Type



AP-NC5000

Multichannel HD Video Codec

Main Features

AP-NC5000 Multi-Channel HD Video Codec

- IP based Audio/Video Encoding/Decoding Solution
- Ten(10) Module Slots for HD Video Modules
- HD Video Encoder Modules
- HD Video Decoder Module
- IP based Network Surveillance Solution
- High-performance Video, Audio, and Voice Service
- Firmware Upgradeable Architecture
- Dual Power Supply Module for Redundancy
- Video Solution with Outstanding Network Service Capability
- Audio/Video Privacy Protection

Hardware Specification

AP-NC5000 Multi-Channel HD Video Codec

High-end
DSP

- High-end Programmable DSP Hardware Architecture
- Ten(10) Video Module Slots
- HD Video Encoder/Decode Module (Ex : AV3000)
 - Network Interface
 - One(1) 10/100/1000Mbps Gigabit Ethernet
 - One(1) Console Port
 - Powerful Video Input/output Interface
 - HD-SDI, HDMI, Analog
 - High quality Audio and Voice Interface
 - Stereo Audio Input/Output Connector
 - Camera Control Interface
 - One(1) RS-232C, RS422, RS485 Interface for Camera Control
 - I/O Interface
 - 2 Alarm Input, 1 Relay
- Module Type Dual Power Supply

Hardware Specification

AP-NC5000 Multi-Channel HD Video Codec

High-end
DSP

AP-NC5000 Front View



HD Video Encoder Module

Power Supply Module



AP-NC3500

Multichannel HD Video Codec

Main Features

AP-NC3500 Multi-Channel HD Video Codec

- IP based Audio/Video Encoding/Decoding Solution
- Four(4) Module Slots for HD Video Modules
- HD Video Encoder Module
- HD Video Decoder Module
- IP based Network Surveillance Solution
- High-performance Video, Audio, and Voice Service
- Firmware Upgradeable Architecture
- Video Solution with Outstanding Network Service Capability
- Internal Power Supply
- Audio/Video Privacy Protection

Hardware Specification

AP-NC3500 Multi-Channel HD Video Codec

High-end
DSP

- High-end Programmable DSP Hardware Architecture
- Four(4) Video Module Slots
- HD Video Encoder/Decode Module (Ex : AV3000)
 - Network Interface
 - One(1) 10/100/1000Mbps Gigabit Ethernet
 - One(1) Console Port
 - Powerful Video Input/output Interface
 - HD-SDI, HDMI, Analog
 - High quality Audio and Voice Interface
 - Stereo Audio Input/Output Connector
 - Camera Control Interface
 - One(1) RS-232C, RS422, RS485 Interface for Camera Control
 - I/O Interface
 - 2 Alarm Input, 1 Relay
- Internal Power Supply

Hardware Specification

AP-NC3500 Multi-Channel HD Network Video Codec

High-end
DSP

AP-NC3500 Front Side View



HD Video Encoder Module

Hardware Specification

AP-NC3500 Multi-Channel HD Network Video Codec

High-end
DSP

AP-NC3500 Back Side View





AP-NC3000

Two(2) Channel HD Video Codec

Main Features

AP-NC3000 Two(2) Channel HD Video Codec

- IP based Audio/Video Encoding/Decoding Solution
- Two(2) Module Slots for HD Video Modules
- HD Video Encoder Module
- HD Video Decoder Module
- IP based Network Surveillance Solution
- High-performance Video, Audio, and Voice Service
- Firmware Upgradeable Architecture
- Video Solution with Outstanding Network Service Capability
- Internal Power Supply
- Audio/Video Privacy Protection

Hardware Specification

AP-NC3000 Two(2) Channel HD Video Codec

High-end
DSP

- High-end Programmable DSP Hardware Architecture
- Two(2) Video Module Slots
- HD Video Encoder/Decode Module (Ex : AV3000)
 - Network Interface
 - One(1) 10/100/1000Mbps Gigabit Ethernet
 - One(1) Console Port
 - Powerful Video Input/output Interface
 - HD-SDI, HDMI, Analog
 - High quality Audio and Voice Interface
 - Stereo Audio Input/Output Connector
 - Camera Control Interface
 - One(1) RS-232C, RS422, RS485 Interface for Camera Control
 - I/O Interface
 - 2 Alarm Input, 1 Relay
- Internal Power Supply

Hardware Specification

AP-NC3000 Two(2) Channel HD Video Codec

High-end
DSP

AP-NC3000 Front View



HD Video Encoder Module





AP-NC2000
One(1) Channel HD Video
Codec

Main Features

AP-NC2000 One(1) Channel HD Video Codec

- IP based Audio/Video Encoding/Decoding Solution
- Single Slot for HD Video Modules
- HD Video Encoder Module
- HD Video Decoder Module
- IP based Network Surveillance Solution
- High-performance Video, Audio, and Voice Service
- Firmware Upgradeable Architecture
- Video Solution with Outstanding Network Service Capability
- Internal Power Supply
- Audio/Video Privacy Protection

Hardware Specification

AP-NC2000 One(1) Channel HD Video Codec

High-end
DSP

- High-end Programmable DSP Hardware Architecture
- One(1) Video Module Slots
- HD Video Encoder/Decode Module (Ex : AV3000)
 - Network Interface
 - One(1) 10/100/1000Mbps Gigabit Ethernet
 - One(1) Console Port
 - Powerful Video Input/output Interface
 - HD-SDI, HDMI, Analog
 - High quality Audio and Voice Interface
 - Stereo Audio Input/Output Connector
 - Camera Control Interface
 - One(1) RS-232C, RS422, RS485 Interface for Camera Control
 - I/O Interface
 - 2 Alarm Input, 1 Relay
- Internal Power Supply

Hardware Specification

AP-NC2000 One(1) Channel HD Video Codec

High-end
DSP

AP-NC2000 Front View



HD Video Encoder Module





Video Modules

Video Modules

High-end
DSP

AV6000N Full HD Video Codec Module
(H.264 1080i, 720P Dual Encoding)



HS3000 HD-SDI Subtitle Generator Module





Error Robust Full HD Video Codec Module AV6000N

Product Overview

AV6000N Full HD Video Codec Module

- Full HD (1080i) Video Encoding/Decoding Service Features
- Video Codec : H.264 HP/MP/BP AVC Video Codec
- **Robust H.264 Temporal Domain SVC(Scalable Video Codec) Support**
- Video Input Interface : HDMI, HD-SDI, Analog (NTSC, PAL)
- Video Output Interface : HDMI, HD-SDI, Analog (NTSC, PAL)
- Dual Bit Streaming Support
- RTSP/RTP, TCP/UDP Protocol Support
- IP based Network Surveillance Solution
- High-performance Video, Audio, and Voice Service
- Firmware Upgradeable Architecture
- Video Solution with Outstanding Network Service Capability
- Web based Management Service
- AP-NC2000D, AP-NC2000, AP-NC3000, AP-NC5000 Platform Available

Hardware Specification

AV6000N Full HD Video Codec Module

RISC
CPU

High-End
VP

- **RISC + Video Processor Computing Power**
- **AV6000N Video Module**
 - **Network Interface**
 - One(1) 10/100/1000Mbps Gigabit Ethernet
 - **Video Interface**
 - One(1) Channel HD-SDI Input
 - One(1) Channel HDMI Input
 - One(1) Channel CVBS Input or Output (selected by DIP Switch)
 - One(1) Channel HD-SDI Output
 - One(1) Channel HDMI Output
 - **One(1) RS-232 Console Interface (RJ45)**
 - **Camera Control Interface**
 - One(1) RS-232C, RS422, RS485 Interface for External Camera Control
 - **I/O Interface**
 - Two(2) Alarm Input /One(1) Relay Out

Hardware Specification

AV6000N Full HD Video Codec Module

RISC
CPU

High-End
VP

Hardware Module Specification

AV6000N HD Video Encoder/Decoder Module(H.264)

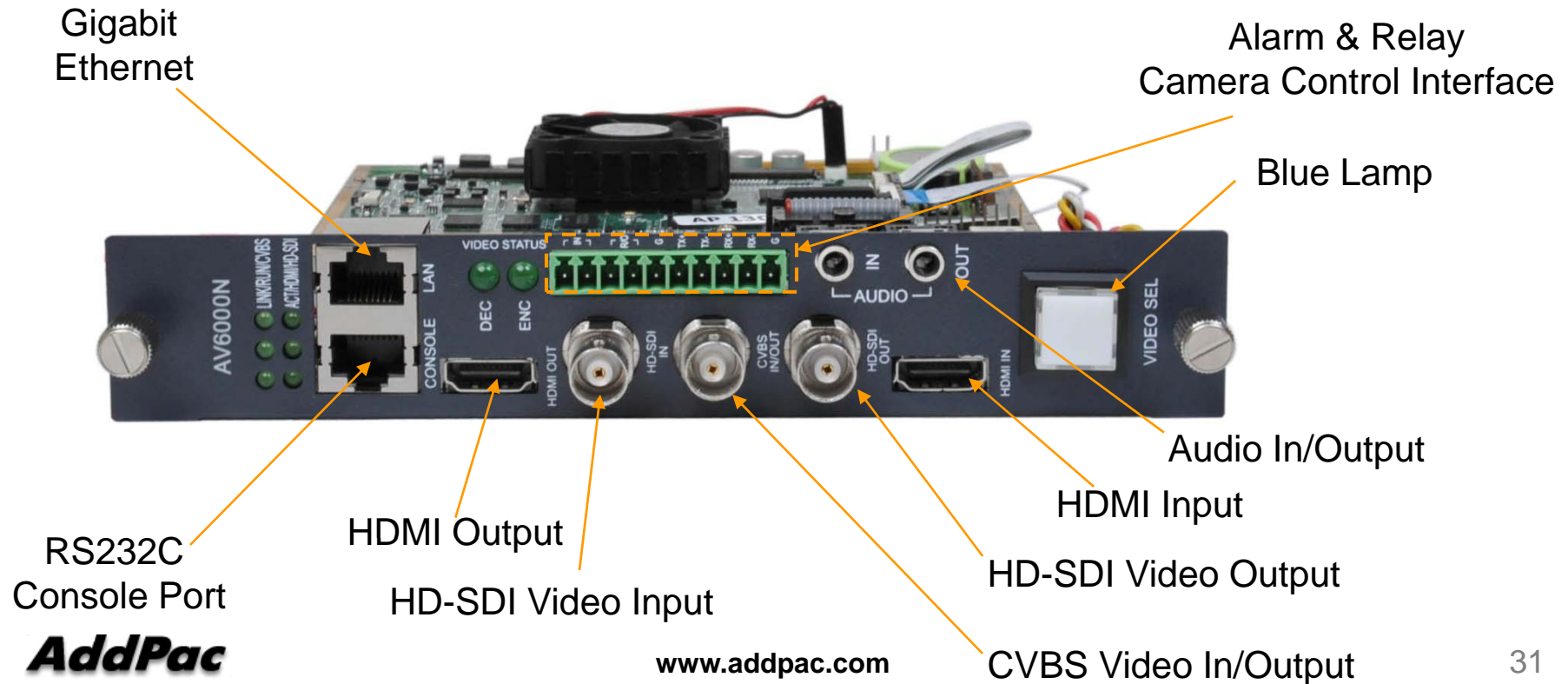

Hardware Specification

AV6000N Full HD Video Codec Module

Hardware Specification

AP-NC2000D Front View



AV6000N HD Video Module



Power On/Off Switch
www.addpac.com

DC Power Supply

Software Service

AV6000N Full HD Video Codec Module

- Built-in AddPac APOS Internetworking Software
 - Scalability, Functionality, and Stability Features
 - Full HD Video Encoding/Decoding Service Features
 - Video Upscale and Downscaling Service
- Firmware Upgradeable Architecture
- Industry Standard Network Protocol Features
- Highly User Friendly Management Features
 - Smart DVR Manager
 - Telnet or RS-232C based Command Line Interface

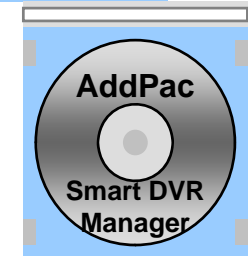
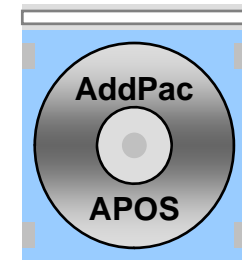

Concurrent Triple Bit Stream Matrix

AV6000N Full HD Video Codec Module

Triple Video Encoding Bit Stream Matrix

Video Input	Concurrent Video Encoding Bit Stream			
	CIF	D1	HD(720P)	FULL HD (1080i)
Analog Video Input (NSTC/PAL)	Available	Available	N/A	N/A
HD-SDI Video Input (720P)	Option	Available	Available	N/A
HD-SDI Video Input (1080i)	Option	Available	Available	Available

RTSP Service Network Diagram

AV6000N Full HD Video Codec Module

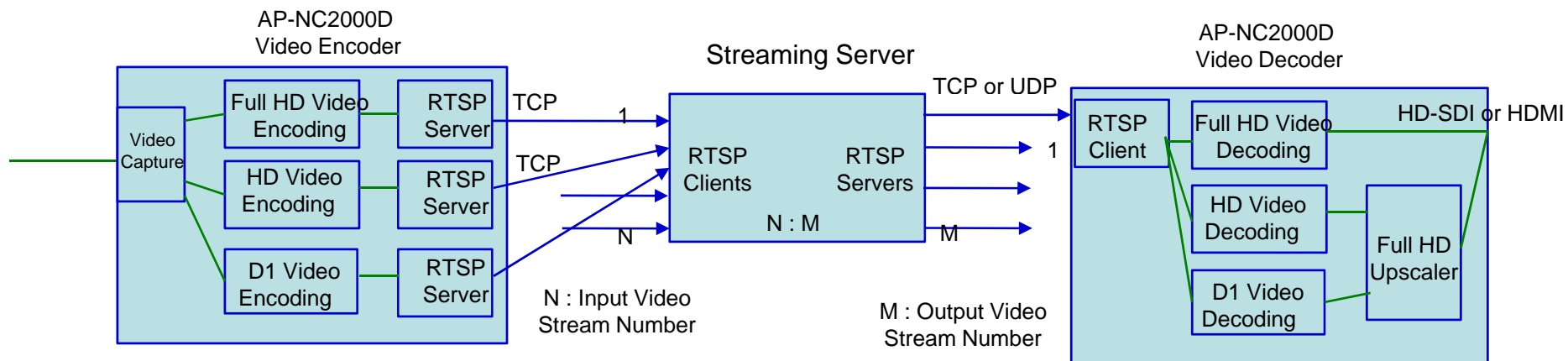
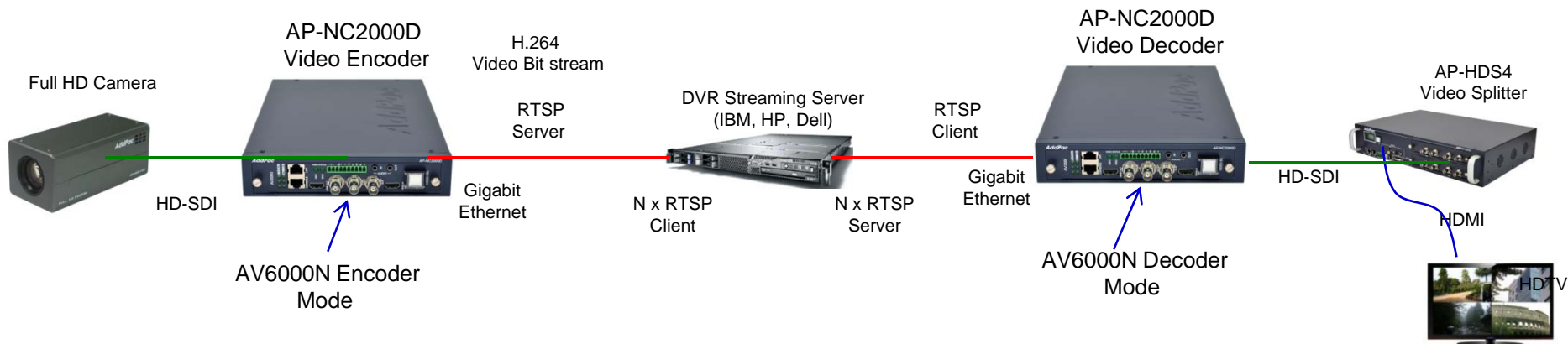

Example (N : M = 64 : 128)

RTSP Service Features

AV6000N Full HD Video Codec Module

- AV6000N Video Encoder Mode
 - RTSP Server Mode
 - Multi-Channel RTSP Server Mode
(Full HD, HD, D1 Triple Encoding Mode or Dual Full HD, HD, etc)
 - RTSP, TCP Protocol Support for Error Robust Service
- AV6000N Video Decoder Mode
 - RTSP Client Mode
 - RTSP/TCP or RTSP/UDP Mode Support

Video Codec Service Features

AV6000N Full HD Video Codec Module

- AV6000N Video Encoder Mode
 - H.264 Full HD(1080i) Single Encoding (HD-SDI Input)
 - H.264 HD(720P) Single Encoding (HD-SDI Input)
 - H.264 D1(720x480) Single Encoding(Analog Input, HD-SDI Input 720P)
 - H.264 Full HD, HD Dual Encoding(HD-SDI Input)
 - **H.264 Full HD, HD, D1 Triple Encoding (HD-SDI Input)**
 - H.264 Full HD, D1 Dual Encoding (HD-SDI Input)
 - H.264 HD, D1 Dual Encoding (HD-SDI Input)
- AV6000N Video Decoder Mode
 - H.264 Full HD
 - H.264 HD, Upscale to Full HD
 - H.264 D1, Upscale to Full HD

Video Codec Service Features

AV6000N Full HD Video Codec Module

AP-NC2000D Video Encoder

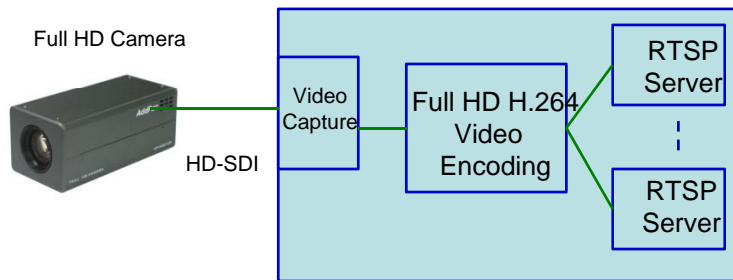

Single Full HD H.264 Video Encoding

AP-NC2000D Video Encoder

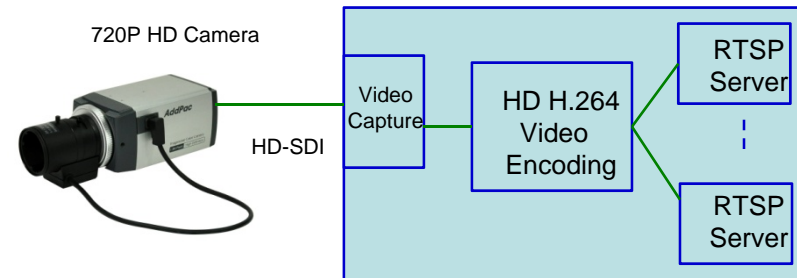

Single HD H.264 Video Encoding

AP-NC2000D Video Encoder

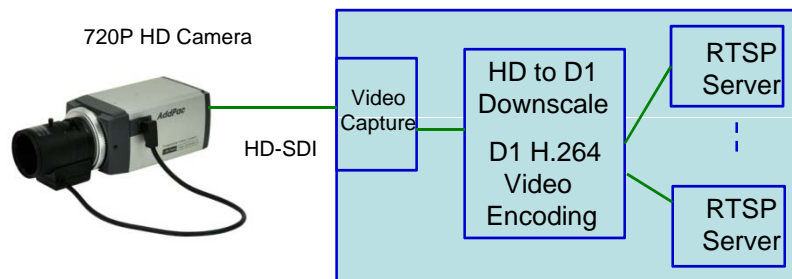

Single D1 H.264 Video Encoding

AP-NC2000D Video Encoder

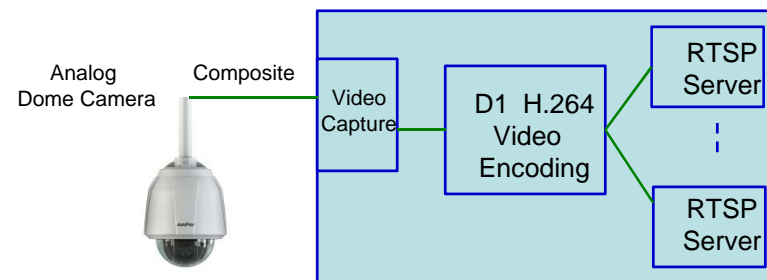

Single D1 H.264 Video Encoding

Video Codec Service Features

AV6000N Full HD Video Codec Module

AP-NC2000D Video Encoder

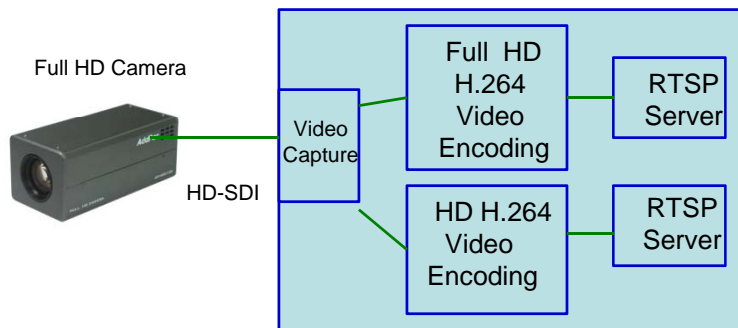

H.264 Full HD, HD Dual Video Encoding

AP-NC2000D Video Encoder

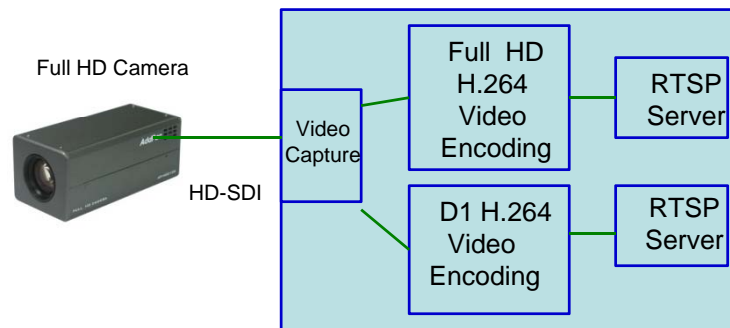

H.264 Full HD, D1 Dual Video Encoding

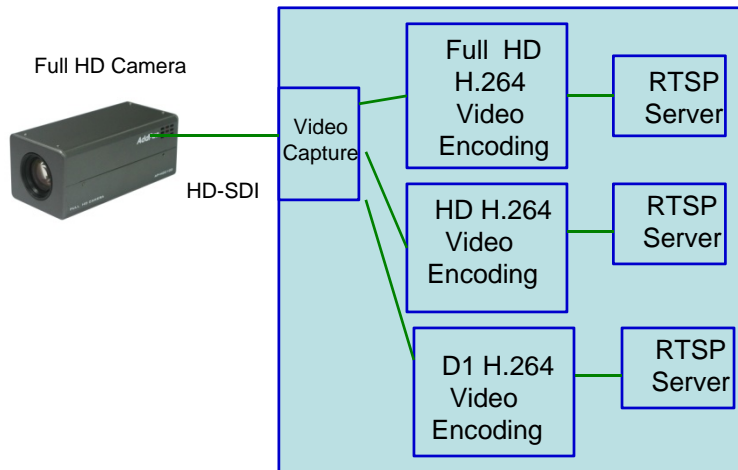

H.264 Full HD, HD, D1 Triple Video Encoding

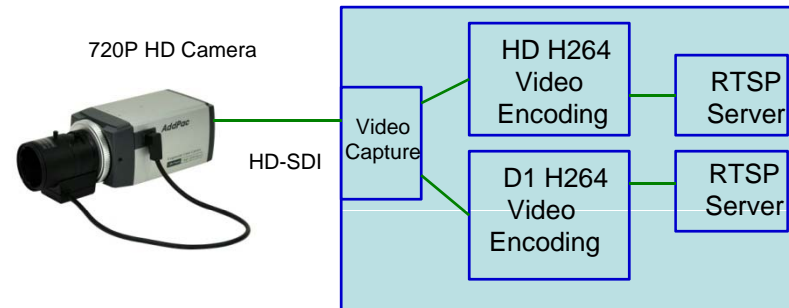

H.264 HD, D1 Dual Video Encoding

Temporal Domain SVC Overview

AV6000N Full HD Video Codec Module

Encoding/Decoding Order for Hierarchical-P

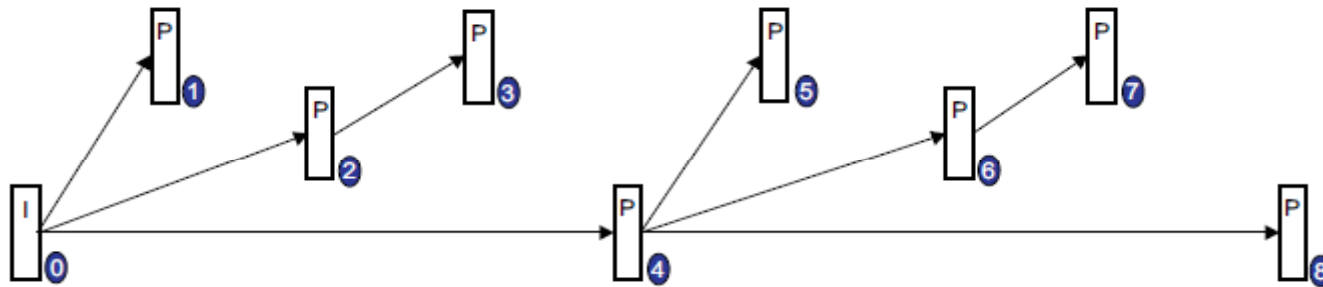

Temporal Layers

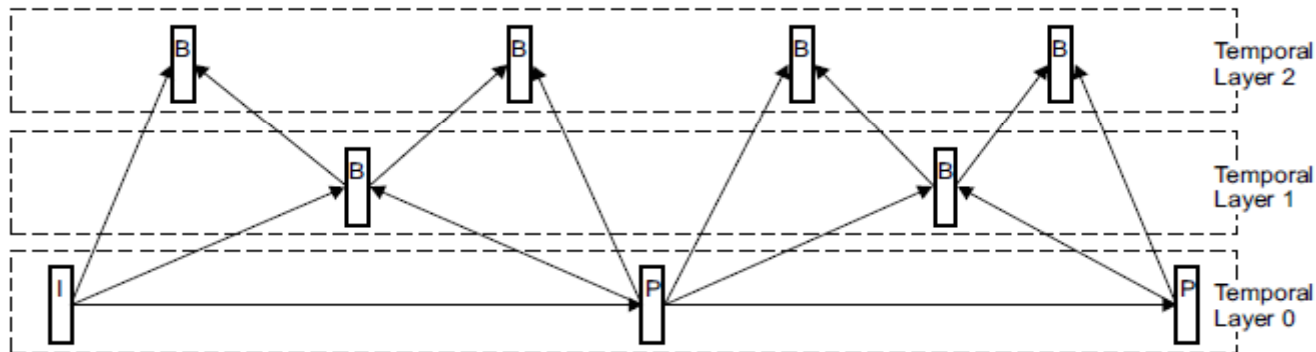

Prefix NAL Unit Syntax as Specified by SVC

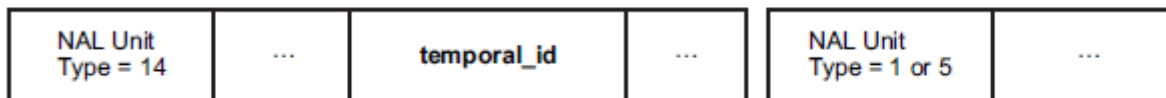

Prefix NAL Unit

H.264/AVC NAL Unit

Temporal Domain SVC Overview

AV6000N Full HD Video Codec Module

SVC: temporal scalability scenario

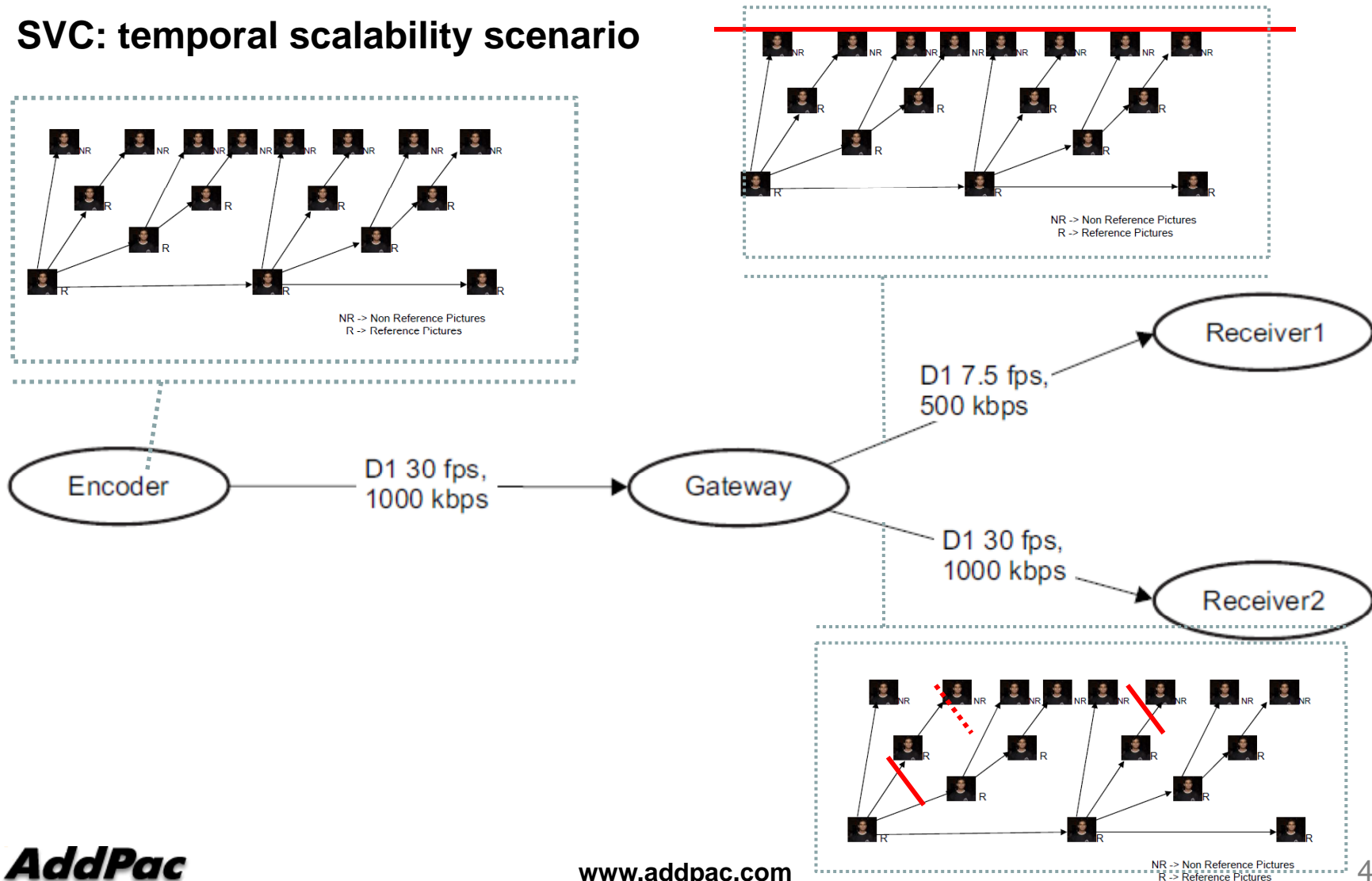



HS3000

HD Subtitle Generator Module

HS3000 HD Subtitle Generator Modules

High-end
DSP

Main Features

- HD-SDI Subtitle Generation Service Features
- PC based Subtitle Controller Software
- High-end Video Processor Architecture
- One(1) 10/100/1000Mbps Gigabit Ethernet Interface
- One(1) RS232C Command Line Interface(RJ45)
- IP based Network Surveillance Solution
- High-performance Video, Audio, and Voice Service
- Firmware Upgradeable Architecture
- Video Solution with Outstanding Network Service Capability
- Audio/Video Privacy Protection

HS3000 HD Subtitle Generator Modules

High-end
DSP

Hardware Specification

- High-end Video Processor Architecture
- Network Interface
 - One(1) 10/100/1000Mbps Gigabit Ethernet (RJ45)
- Command Line Interface
 - One(1) RS-232C Interface (RJ45)
- Video Interface
 - Video Input : 1 Channel Video Input (HD-SDI)
 - Video Output : 1 Channel Video Output (HD-SDI)

HS3000 HD Subtitle Generator Modules

High-end
DSP

HS3000 HD-SDI Subtitle Generator Module Specification

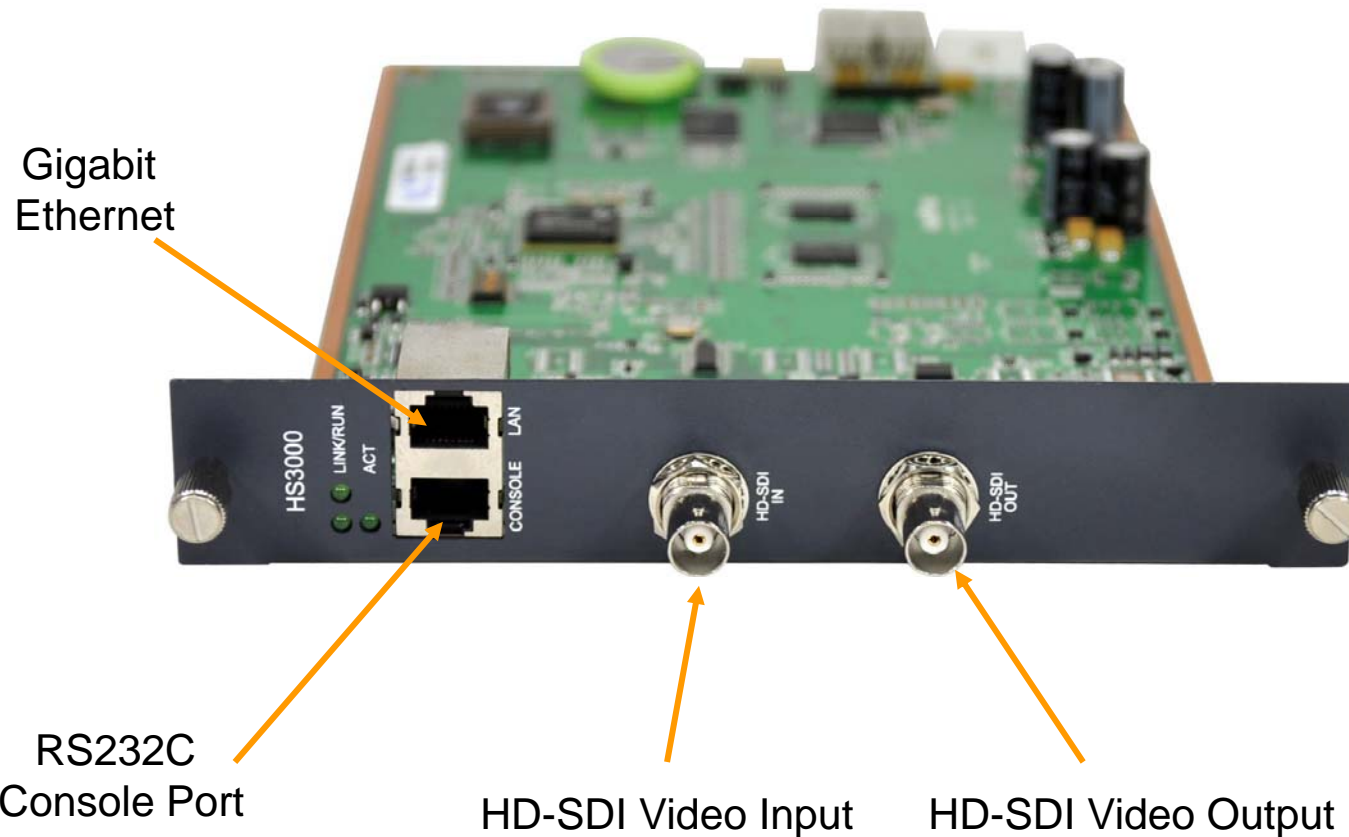



Thank you!

AddPac Technology Co., Ltd.
Sales and Marketing

Phone +82.2.568.3848 (KOREA)

FAX +82.2.568.3847 (KOREA)

E-mail sales@addpac.com