

# Enterprise Traffic Control Solution



**AddPac**

**AddPac Technology**

Sales and Marketing

[www.addpac.com](http://www.addpac.com)

# Contents

- Enterprise Traffic Control Network Diagram
- Enterprise Traffic Control Product
  - AP-TC1000 Traffic Controller
- QoS Service and Features
- Network Service and Features
- QoS Manager Software

# Enterprise Traffic Control Network Diagram

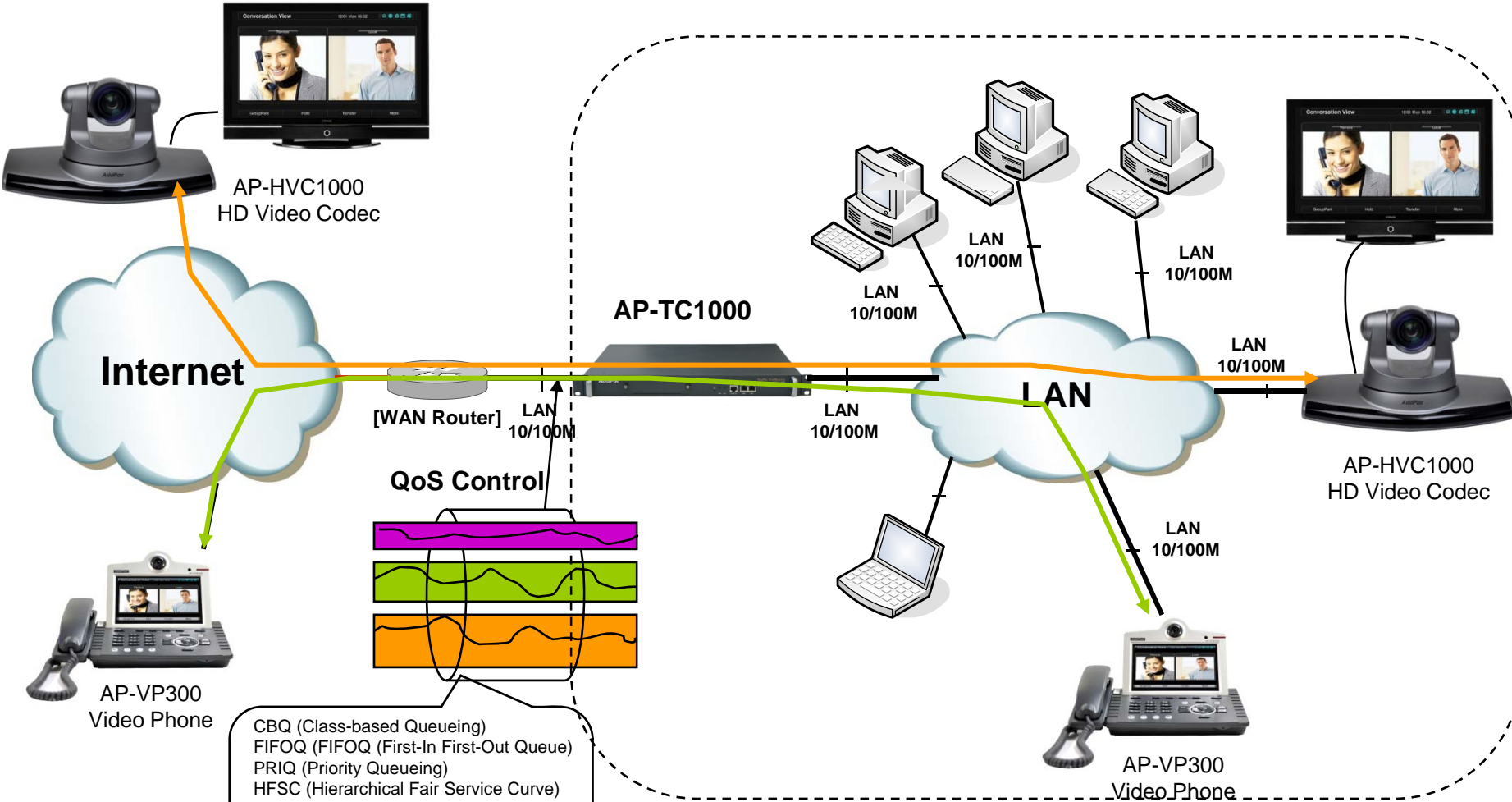

- CBQ (Class-based Queueing)
- FIFOQ (FIFOQ (First-In First-Out Queue))
- PRIQ (Priority Queueing)
- HFSC (Hierarchical Fair Service Curve)
- RED(Random Early Detection)
- RIO (RED with In/Out)
- BLUE
- JoBS
- WFQ (Weighted Fair Queueing)

# Enterprise Traffic Control Network Diagram

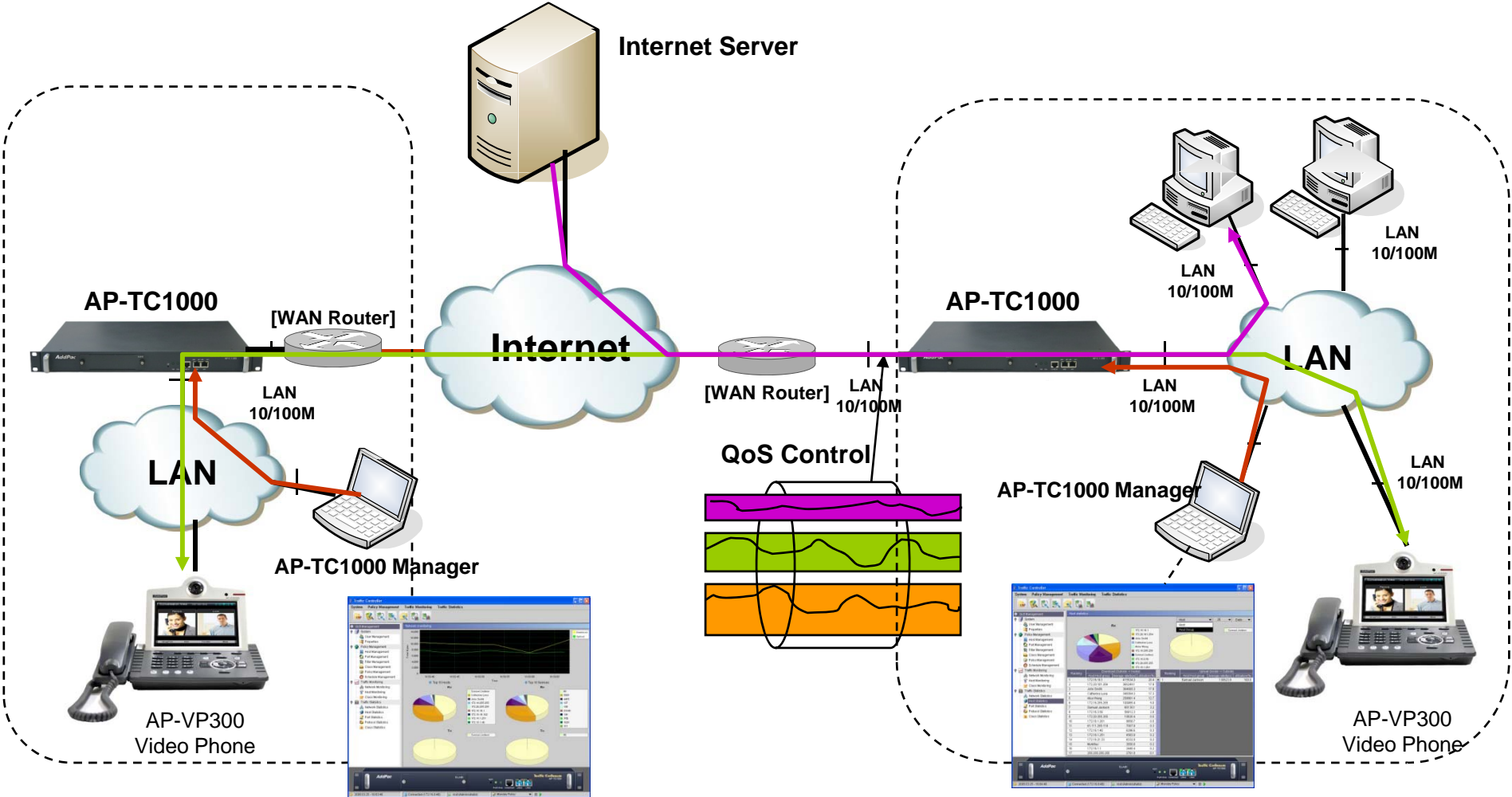

# Enterprise Traffic Control Network Diagram

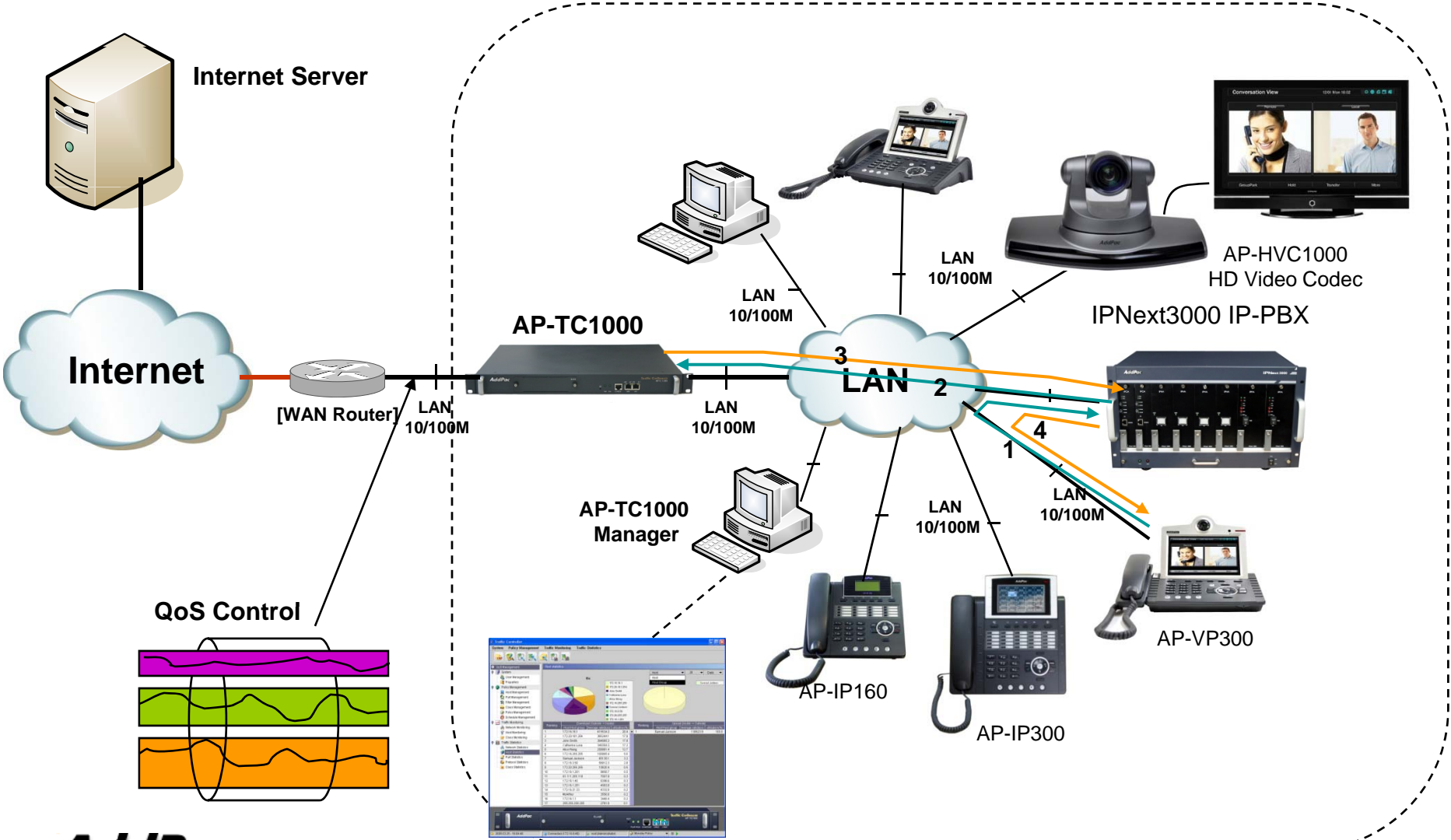

**AddPac**

[www.addpac.com](http://www.addpac.com)



# Enterprise Traffic Control Product AP-TC1000

# Product Overview

## AP-TC1000 Traffic Controller

- Embedded Hardware System and Real-Time OS
- LAN-to-LAN QoS Routing
- Various Network Interface Module Such as ATM, POS, V.35,etc
- Support Various QoS Algorithm & Police
- Powerful Management and User Friendly Features
- Graphical QoS Manager
- CLI Interface for Detailed Control
- Firmware Upgradeable Architecture

# Hardware Specification

## AP-TC1000 Traffic Controller

- High-End RISC Microprocessor Computing Power
- Main Chassis
  - Fixed Network Interface
    - LAN 0 : 10/100Mbps Fast Ethernet
    - LAN 1 : 10/100Mbps Fast Ethernet
    - One(1) RS-232C Console (RJ45)
  - One(1) Network Interface Module Slot for WAN Access

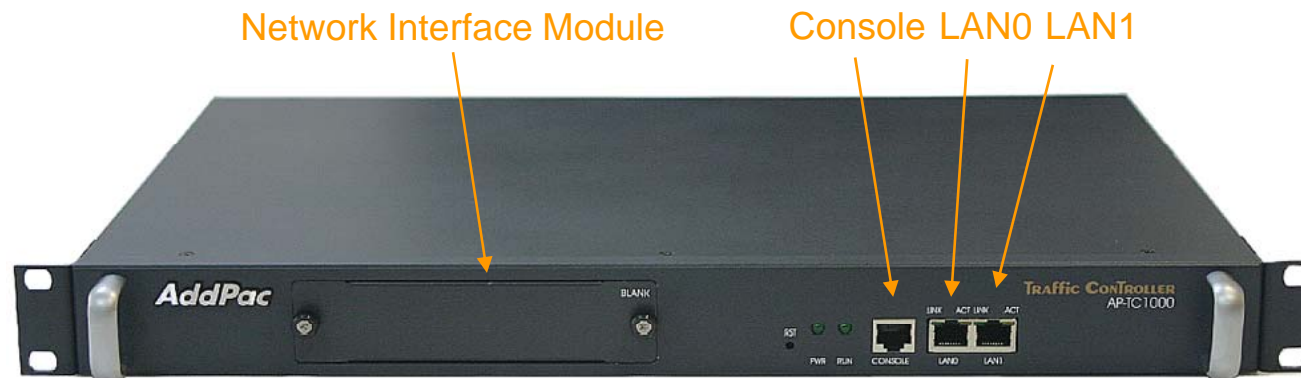









# Hardware Specification

AP-TC1000 Traffic Controller

ATM  
SAR

V.35

- Network Module

AIM-ATMOC3-1		1-Port OC3 155Mbps ATM Network Interface Module
AIM-ATMDS3-1		1-Port DS3 45Mbps ATM Network Interface Module
AIM-ATM1E1		1-Port ATM E1 Network Interface Module
AIM-V35FR1		1-Port V.35 Interface Module
AIM-V35FR2		2-Port V.35 Interface Module
AIM-V35FR6		6-Port V.35 Interface Module



# QoS Service and Features

# QoS Service and Features

## AP-TC1000 Traffic Controller

- **Queuing and Traffic control**

- CBQ (Class-based Queuing)
- FIFOQ (FIFOQ (First-In First-Out Queue))
- PRIQ (Priority Queuing)
- HFSC (Hierarchical Fair Service Curve)
- RED (Random Early Detection)
- RIO (RED with In/Out)
- BLUE
- JoBS
- WFQ (Weighted Fair Queuing)

- **ECN (Explicit Congestion Notification) RFC3168 support**

- Packet marking/remarking (DSCP, ToS, Precedence)
- ECN support in TCP
- Fragment/tunnel handling in IPv4/IPv6

# QoS Service and Features

AP-TC1000 Traffic Controller

Queuing and Traffic control	CBQ (Class-based Queuing)
	FIFOQ (FIFOQ (First-In First-Out Queue))
	PRIQ (Priority Queuing)
	HFSC (Hierarchical Fair Service Curve)
	RED (Random Early Detection)
	RIO (RED with In/Out)
	BLUE
	JoBS
ECN (Explicit Congestion Notification) RFC3168 support	WFQ (Weighted Fair Queuing)
	Packet marking/remarking (DSCP, ToS, Precedence)
	ECN support in TCP
	Fragment/tunnel handling in IPv4/IPv6



# Network Service and Features

# Network Service and Features (Cont..)

## AP-TC1000 Traffic Controller

- **Basic Routing Function**
  - IPv4/IPv6 Dual Stack
  - Management
    - Telnet, FTP, TFTP, SSH, SNMP, Syslog support
    - Packet filtering (Access-list)
  - Routing
    - Static, RIP, RIPng, OSPFv2/v3, BGP4
- **QoS Routing Support.**
  - Source Address based routing
  - DSCP based Routing
  - Service Class based routing

# Network Service and Features (Cont..)

## AP-TC1000 Traffic Controller

- **Network Managements**

- Cisco CLI based.
  - access-list, class-map, policy-map, service-policy
- SNMP Support
  - Support same QoS functions with Cisco CLI
- Embedded HTTP Server
- Classify and Control
  - Cisco class-map and policy-map Based
  - Automatic
- Traffic Monitoring and Report
  - Utilization, Top Users and Application, Traffic History
  - Active Flows
- Event Notification
  - SNMP Trap, E-mail, Syslog

# Network Service and Features

## AP-TC1000 Traffic Controller

- Security Functions
  - Standard & Extended IP Access List
  - Enable/Disable for Specific Network Protocols
  - Multi-level User Account Management
  - Auto-disconnect for Telnet/Console Sessions
  - PPP User Authentication Supports (PAP & CHAP)
- Operation & Managements
  - System Performance Analysis for Process, CPU, Connection Interface
  - Debugging, System Auditing, and Diagnostics Support
  - System Booting and Auto-rebooting with Watchdog Feature
  - System Managements with Data Logging
  - IP Traffic Statistics with Accounting





# QoS Manager Software

# QoS Manager (Example)

AP-TC1000 Traffic Controller Manager

The screenshot displays the Traffic Controller web interface. The main content area shows the Host Management section with a table of hosts. The table has columns for Host name, Host, and Description. The status bar at the bottom shows the date and time (2005.03.25 - 16:04:21), connection status (Connected (172.16.8.48)), user (root (Administrator)), and policy (Monday Policy).

Host name	Host	Description
장진영pc	172.16.1.18	NMS팀
최진석pc	172.16.1.19	
장병주pc	172.16.1.20	NGN Team
김상미pc	172.16.1.28	Soft-switch team
김경남pc	172.16.1.21	
권종휘pc	172.16.1.22	
김도형pc	172.16.1.23	NGN
강진선pc	172.16.1.24	
김광pc	172.16.1.25	
권영필pc	172.16.1.26	
이명원pc	172.16.1.27	
김휘용pc	172.16.1.30	Video 팀
조경석pc	172.16.1.31	
박중영pc	172.16.1.32	
김창연pc	172.16.1.33	
박규홍pc	172.16.1.34	
한규역pc	172.16.1.41	S/E 팀

# QoS Manager (Example)

AP-TC1000 Traffic Controller Manager

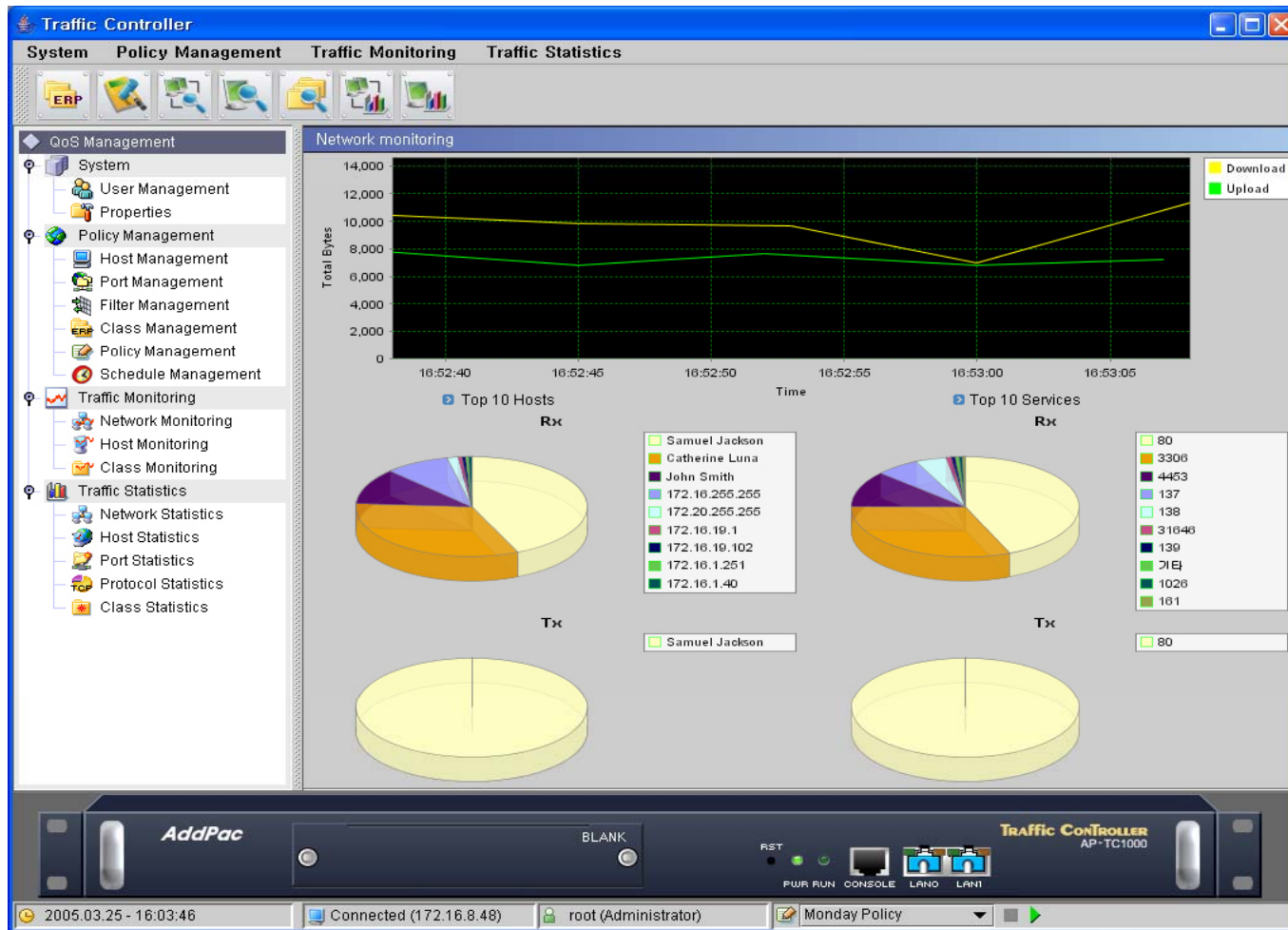

# QoS Manager (Example)

AP-TC1000 Traffic Controller Manager

The screenshot displays the Traffic Controller web interface. The left sidebar shows a navigation tree with categories like QoS Management, Policy Management, Traffic Monitoring, and Traffic Statistics. The main content area is titled 'Host statistics' and features a 3D pie chart labeled 'Rx' showing traffic distribution across various hosts. Below the chart is a table with two sections: 'Download (Outside → inside)' and 'Upload (Inside → Outside)'. The table lists hosts with their IP addresses, average rates in bps, and utilization percentages. At the bottom of the interface, there is a status bar showing the date and time (2005.03.25 - 16:04:48), connection status (Connected (172.16.8.48)), user role (root (Administrator)), and the active policy (Monday Policy).

Download (Outside → inside)				Upload (Inside → Outside)			
Ranking	Host-Host group	Average rate(bps)	utilization(%)	Ranking	Host-Host group	Average rate(bps)	utilization(%)
1	172.16.19.1	415534.3	20.4	1	Samuel Jackson	130623.9	100.0
2	172.20.101.254	365244.1	17.9				
3	John Smith	364665.3	17.9				
4	Catherine Luna	349384.3	17.2				
5	Alice Wang	258861.4	12.7				
6	172.16.255.255	100985.4	5.0				
7	Samuel Jackson	65135.1	3.2				
8	172.16.3.50	56912.3	2.8				
9	172.20.255.255	10820.4	0.5				
10	172.16.1.201	9858.7	0.5				
11	61.111.255.119	7007.9	0.3				
12	172.16.1.40	6396.6	0.3				
13	172.16.1.251	4583.9	0.2				
14	172.16.21.33	4332.9	0.2				
15	McArthur	3550.8	0.2				
16	172.16.1.1	3448.4	0.2				
17	255.255.255.255	2761.8	0.1				

# QoS Manager (Example)

AP-TC1000 Traffic Controller Manager

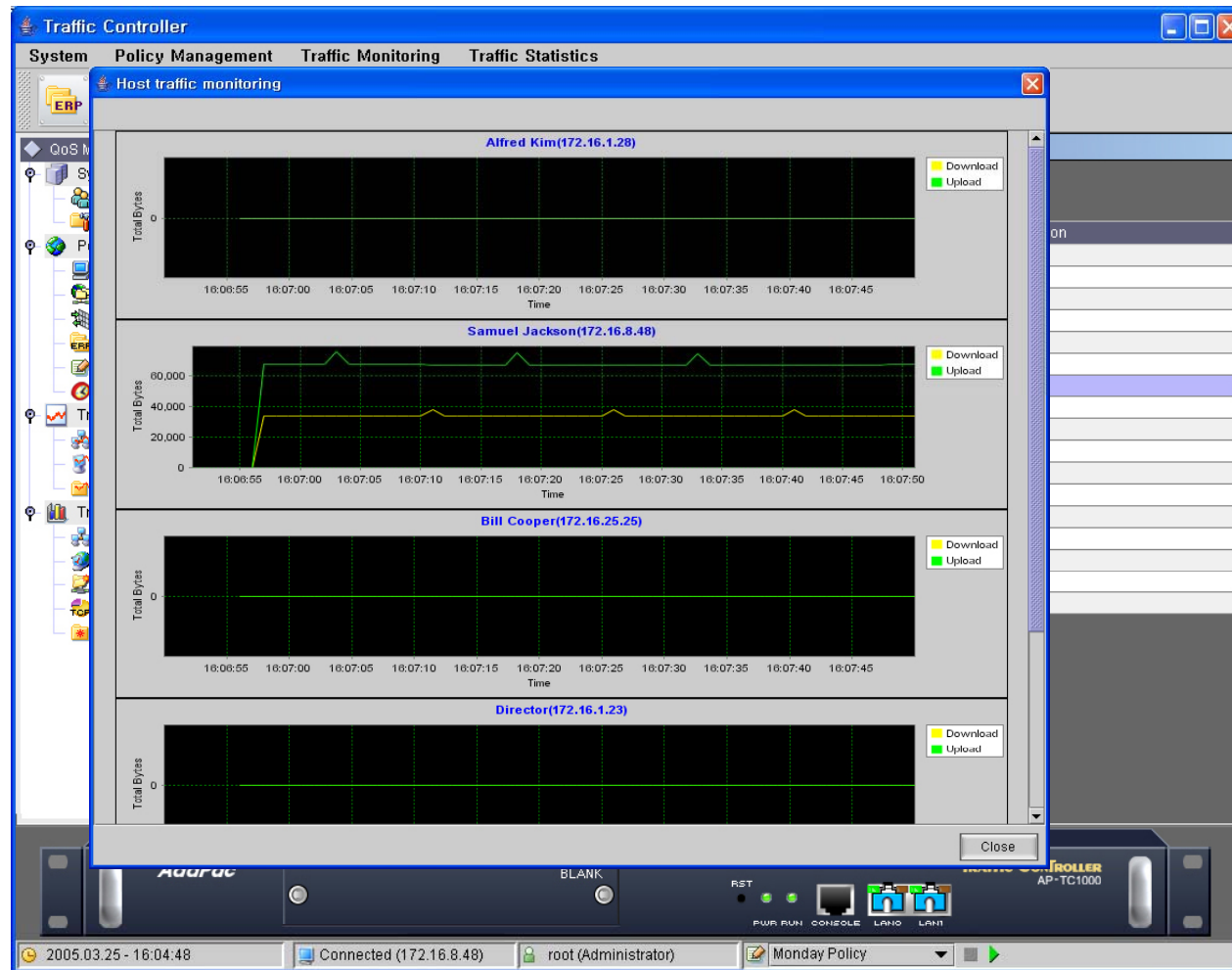



# Thank you!

**AddPac Technology Co., Ltd.**  
Sales and Marketing

Phone +82.2.568.3848 (KOREA)

FAX +82.2.568.3847 (KOREA)

E-mail:sales@addpac.com