

Smart Desktop Meeting Solution

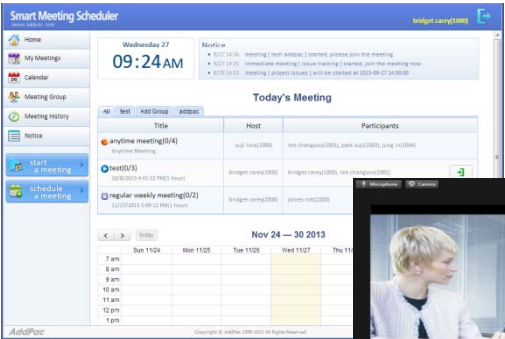

MS-Window based Video Conference

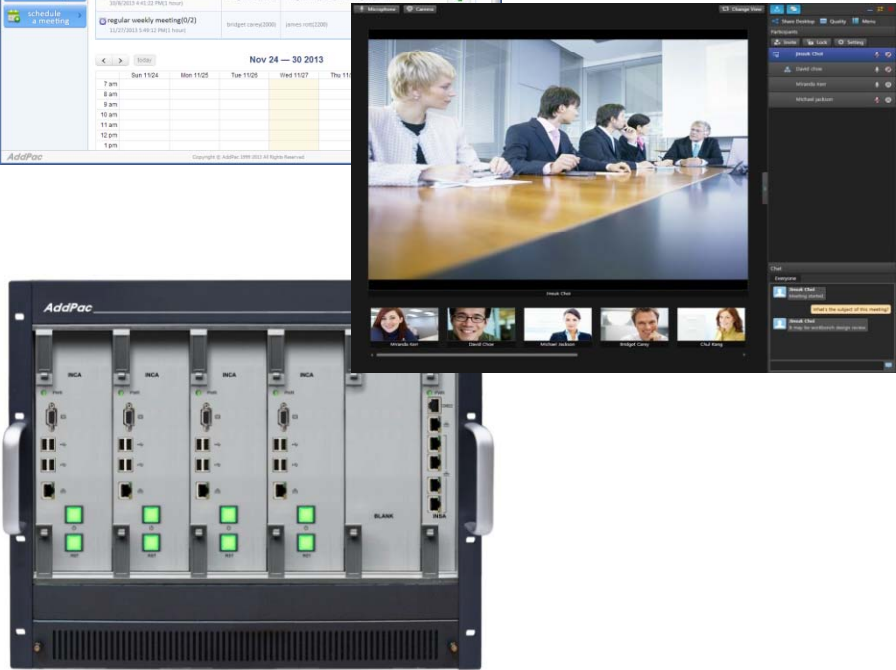

AddPac

AddPac Technology

Sales and Marketing

www.addpac.com

Contents

- Smart Desktop Meeting Solution Network Diagram
- Smart Desktop Meeting Solution Advantage
- Smart Desktop Meeting Solution Overview
- Smart Desktop Meeting Solution Application
- Smart Desktop Meeting Solution Components
 - Smart Meeting Schedule
 - Smart Meeting Messenger
 - Smart Meeting Previewer
 - Smart Meeting Place
 - Smart Desktop Meeting Server
- HD Video Conference Devices

Smart Desktop Meeting Solution Network Diagram

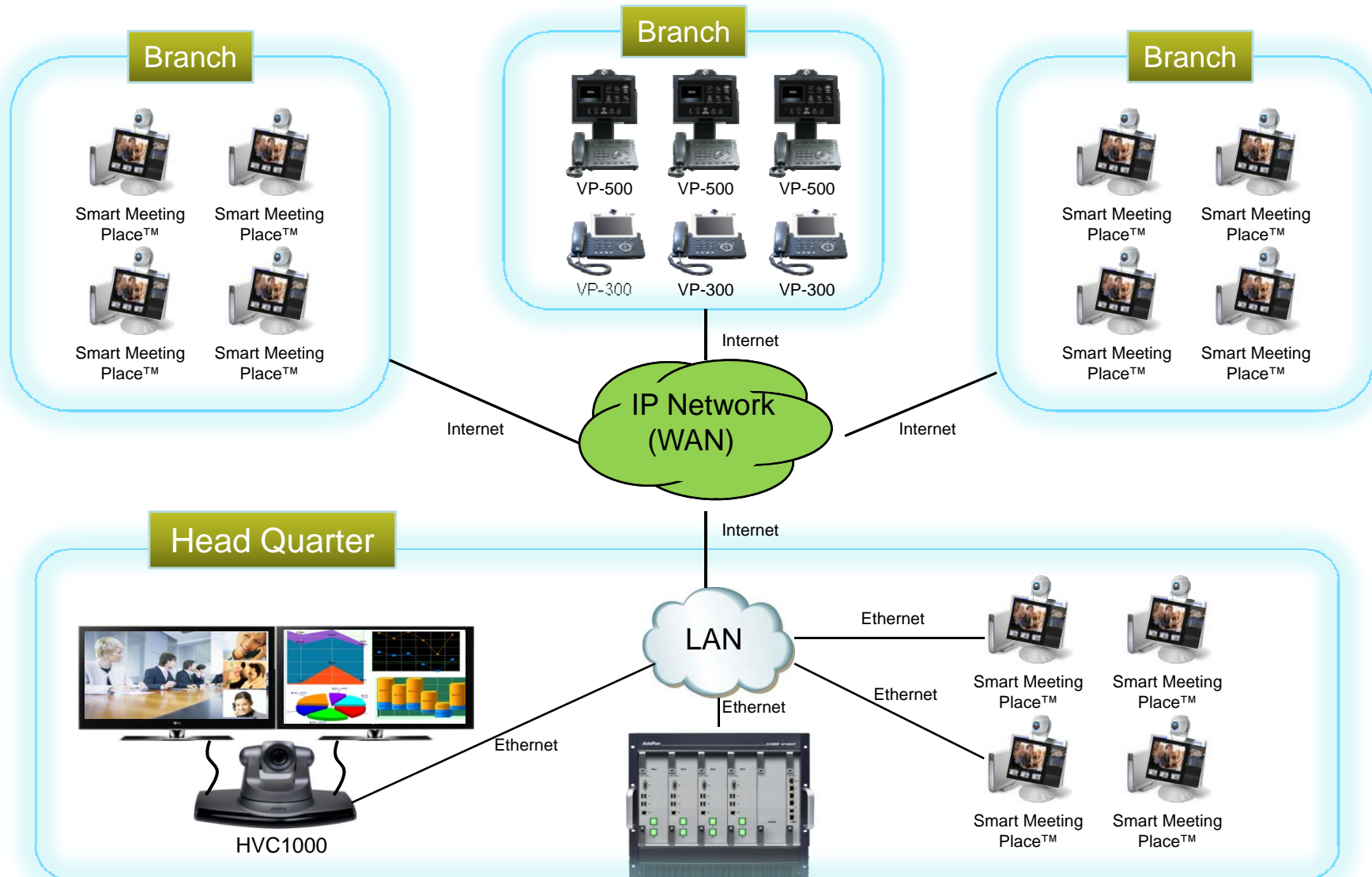

Advantages of AddPac Desktop Meeting Solution

- Provides Full Desktop Meeting Solution by [Smart Meeting Scheduler™](#), [Smart Meeting Messenger™](#), [Smart Meeting Previewer™](#), and [Smart Meeting Place™](#)
- Provides Modular and Reliable Servers such as [Call Manager](#), [Presence Server](#), [MCU \(Multiparty Conference Unit\)](#), and [Meeting Server](#) with Active-Standby Redundancy
- Provides [Video Traffic Optimizer™](#) Technology by MCU with Flexible Window Management
- Provides Preview of Participants before Join to the Meeting by [Smart Meeting Previewer™](#)
- Provides Flexible Meeting and Video Conferencing Solutions for Government, Enterprise, Education, Healthcare Areas with AddPac [HD Hardware Codecs](#), [Video Phones](#), and [IP Phones](#).



Smart Desktop Meeting Solution Overview

Smart Desktop Meeting Solution Components

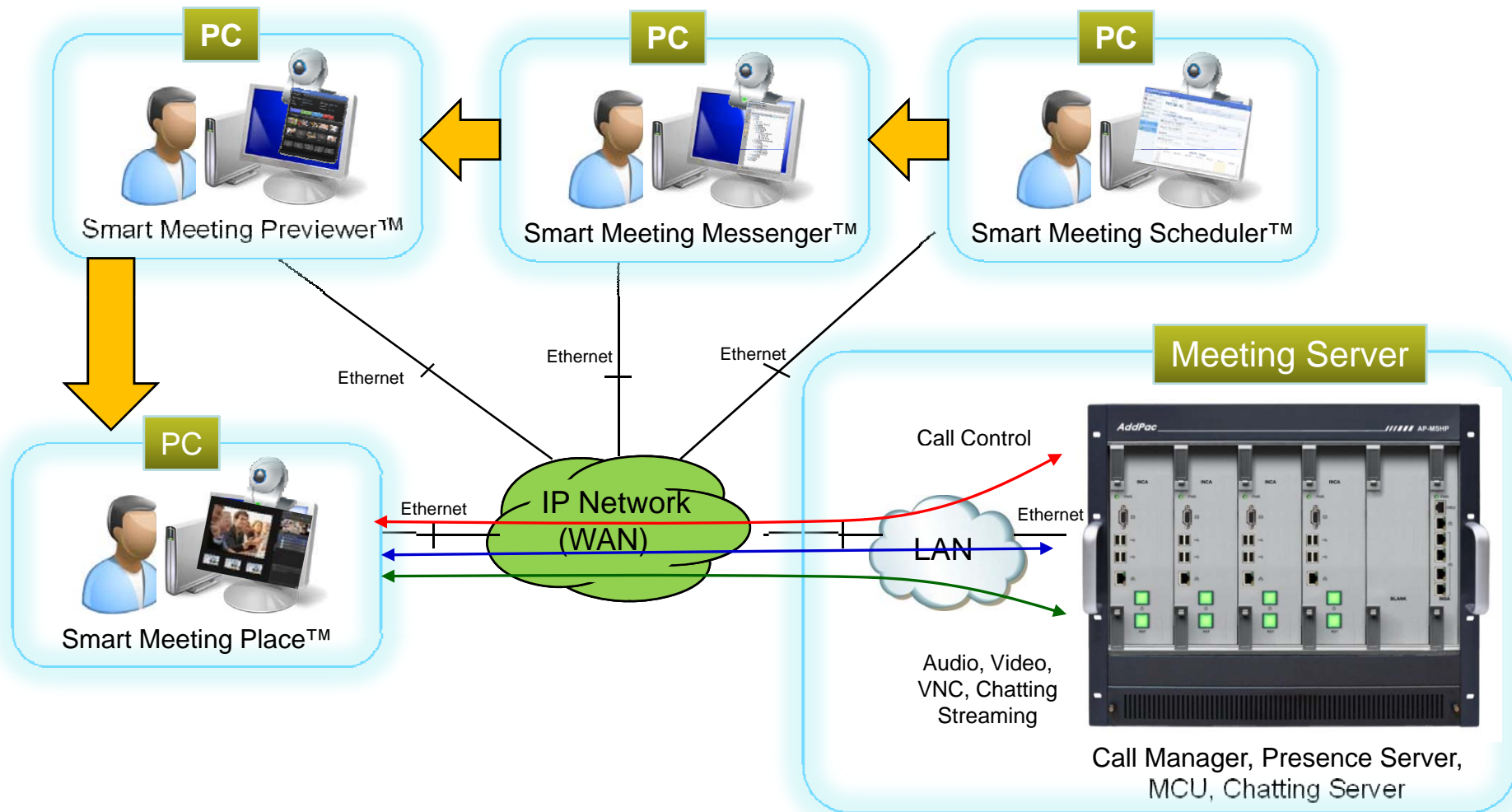

Smart Desktop Meeting Solution Components

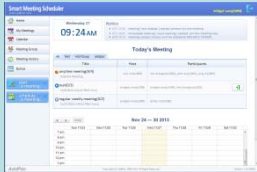

Smart Meeting Scheduler™

- Web based Easy and Intuitive GUI
- Start a Meeting Immediately
- Schedule a Meeting
- Send Invitation E-mail
- Join to a Meeting
- My Meetings
- Calendar
- Meeting History, Notice



Smart Meeting Messenger™

- Receive a Meeting Invite
- Receive a Meeting Notice
- Start/Preview/Join to a Meeting
- Receive Directory
- Receive Presence
- Edit Phone book



Smart Meeting Previewer™

- Preview Current Meeting Room
- Show Thumbnail Video of Joined Participants
- Join to Live Meeting



Smart Meeting Place™

- HD Video Conference
- Audio Conference
- Floor, Presenter Control
- Layout Control
- Desktop Share
- Desktop Control
- Chatting

Schedule a Meeting by Smart Meeting Scheduler

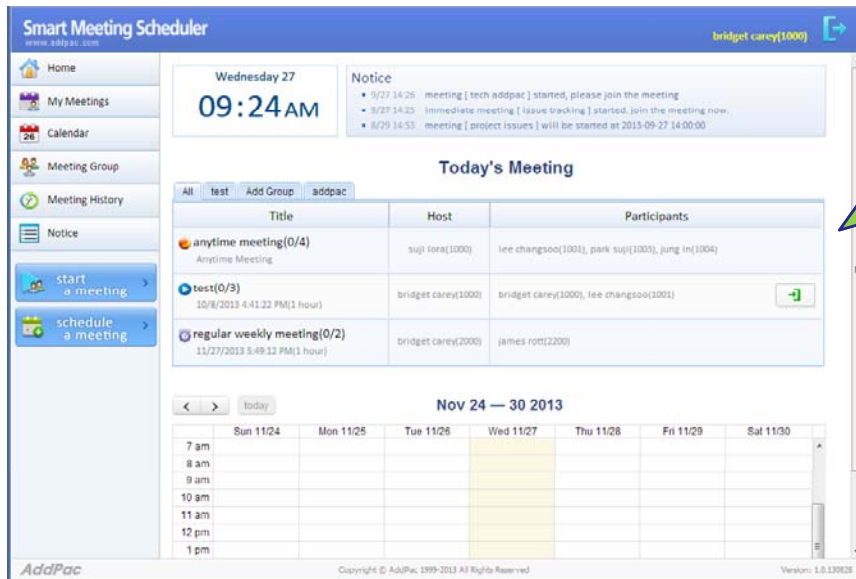

- Web based Easy and Intuitive GUI
- Start a Meeting Immediately
- Schedule a Meeting
- Send Invitation E-mail
- Join to a Meeting
- My Meetings
- Calendar
- Meeting History
- Meeting Notice

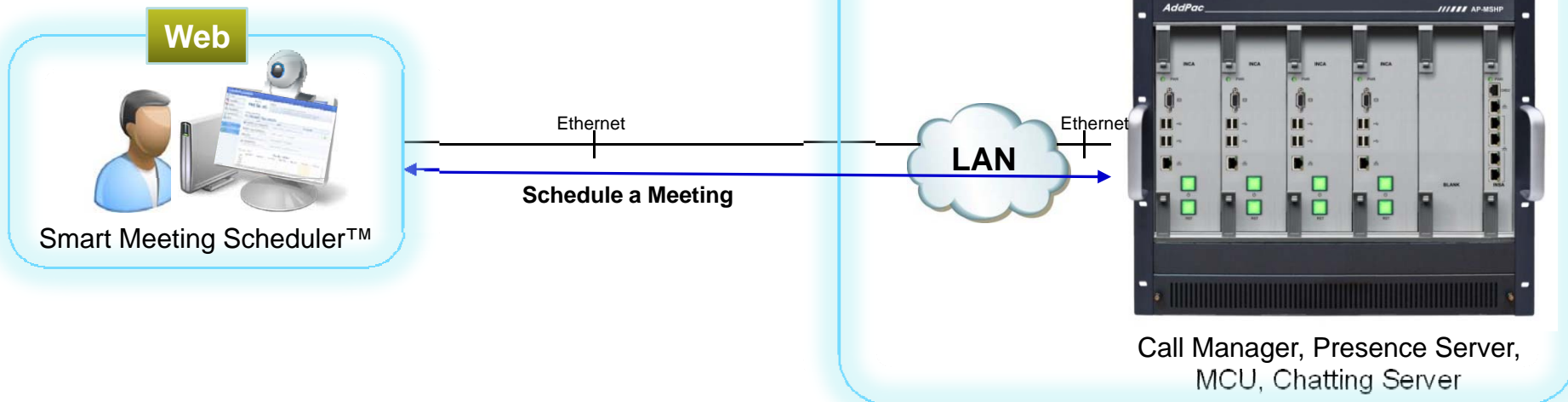

Get a Notification by Smart Meeting Messenger

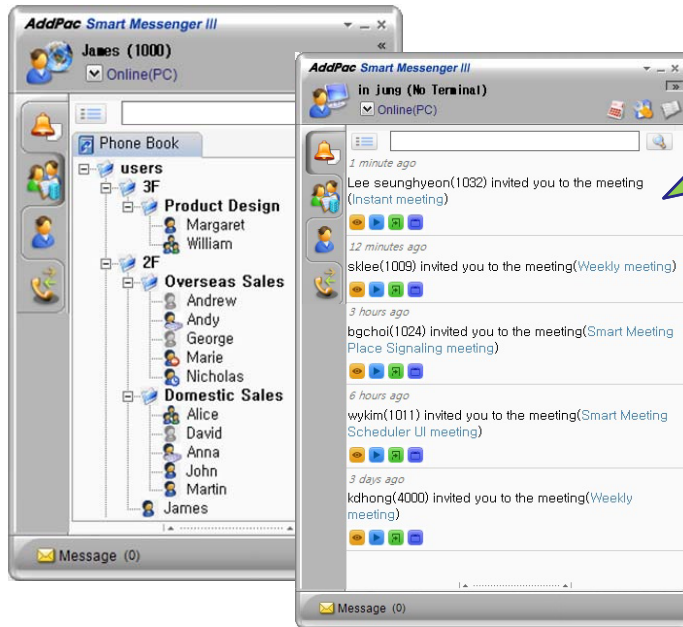

- Receive a Meeting Invite
- Receive a Meeting Notice
- Start/Preview/Join to a Meeting
- Receive Directory
- Receive Presence
- Edit Phone book

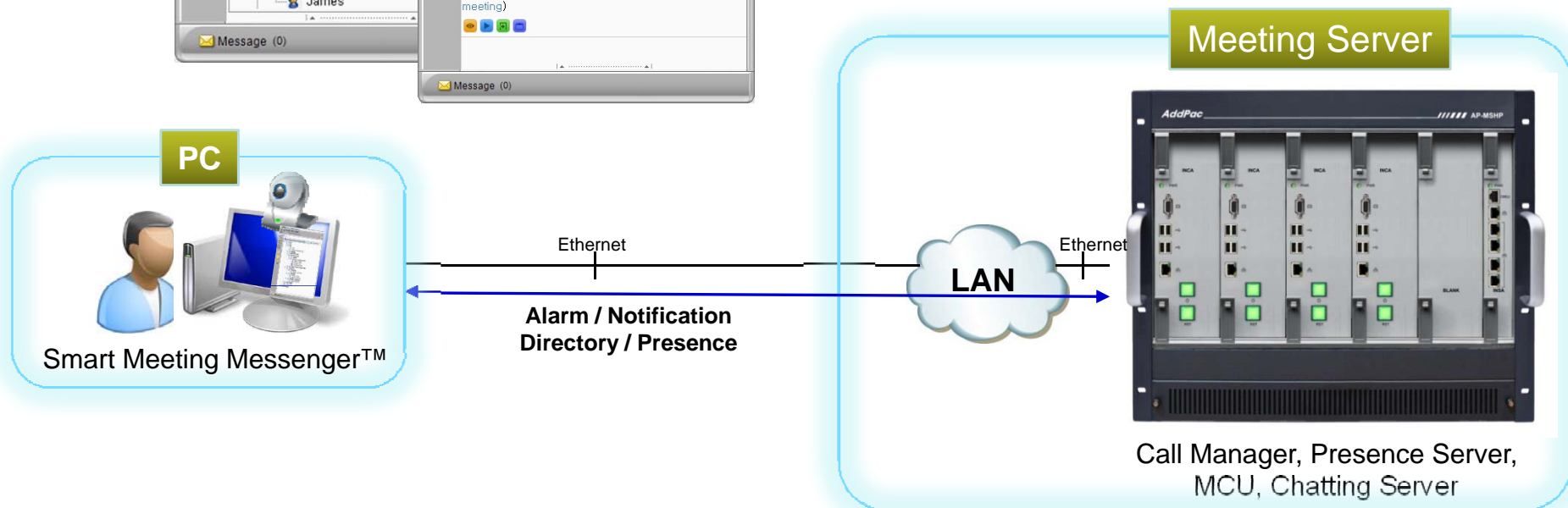

Preview Meeting by Smart Meeting Previewer

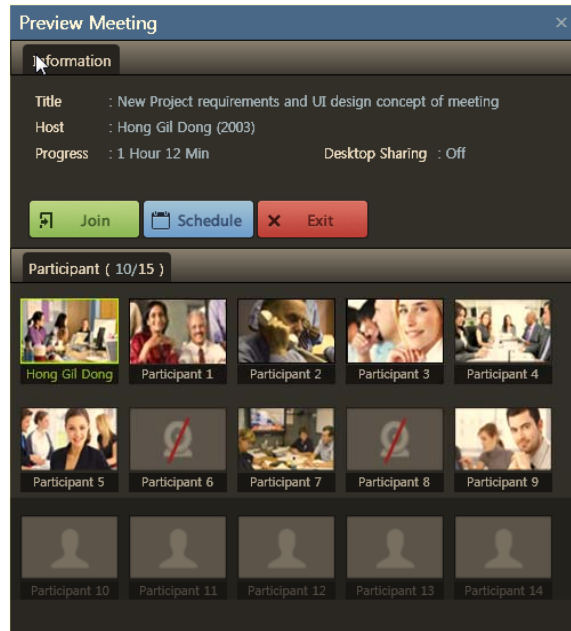

- Preview Current Meeting Room
- Show Thumbnail Video of Joined Participants
- Join to Live Meeting

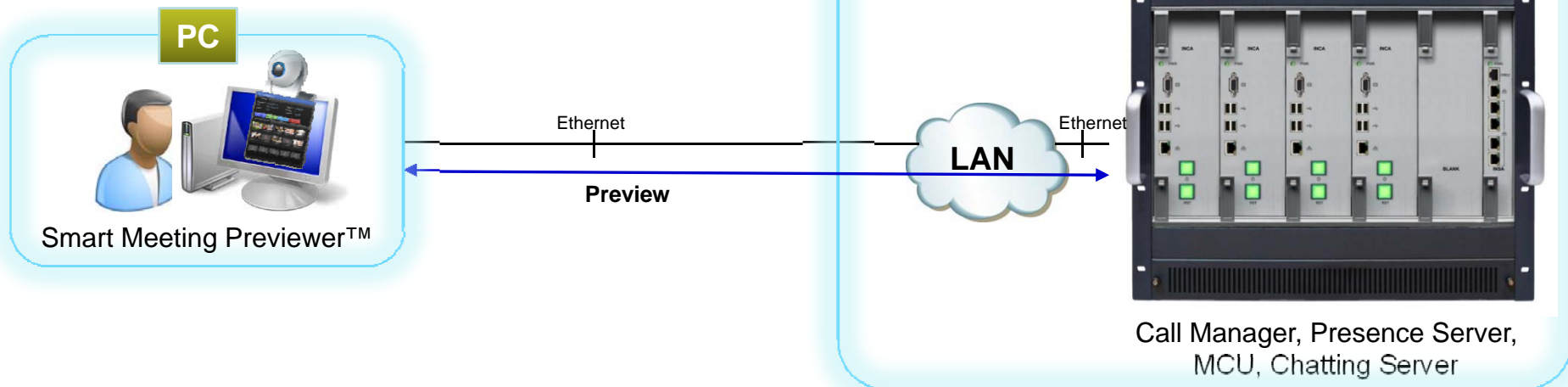

Join Meeting by Smart Meeting Place



- HD Video Conference
- Audio Conference
- Floor, Presenter Control
- Layout Control
- Desktop Share
- Desktop Control
- Chatting

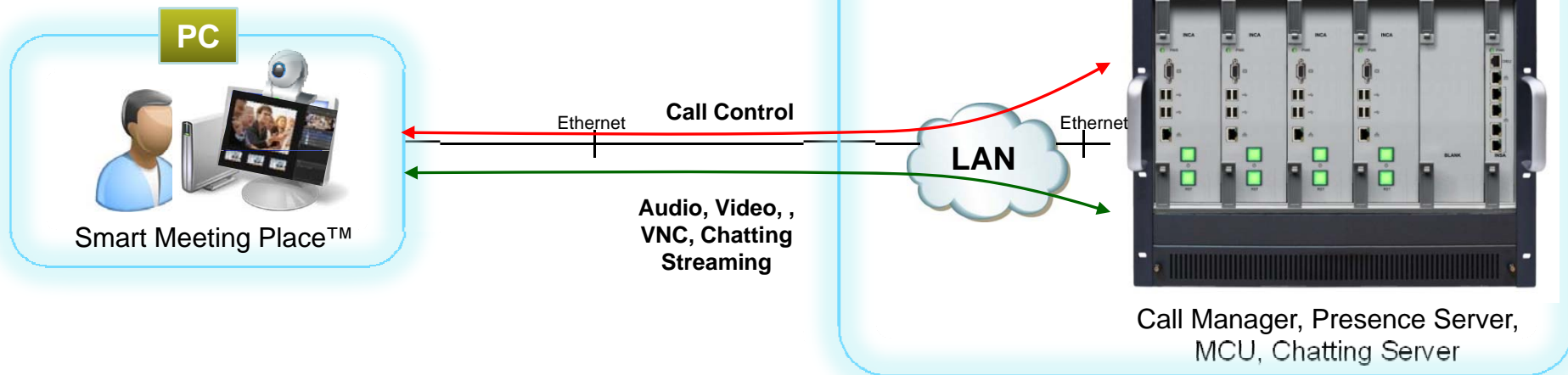

High Availability

- Active-Standby Mode for Call Manager
- Active-Standby Mode for Presence Server
- Active-Active Mode for MCU

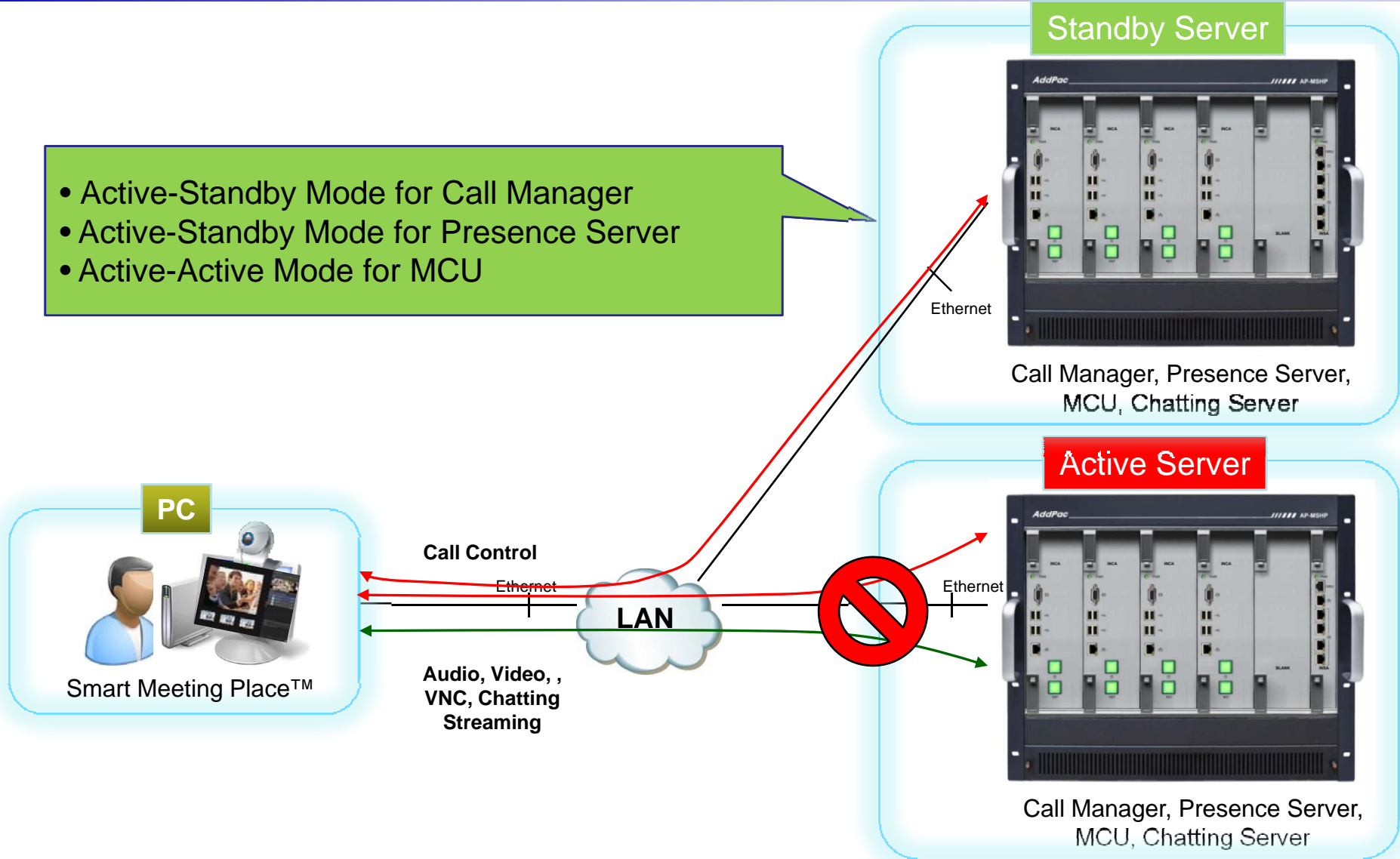

Bandwidth Problem of Other Vendors

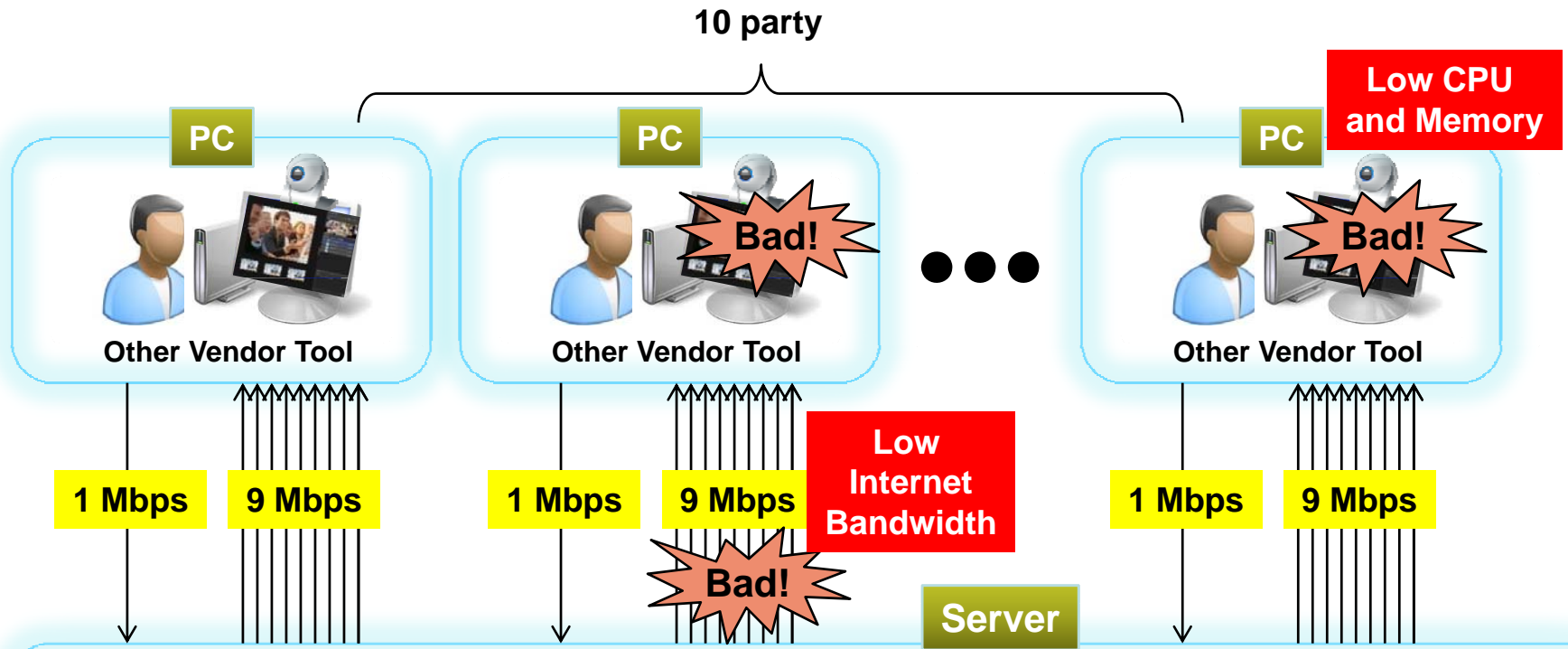

- Downstream bandwidth from server to client increase by number of clients.
- In case of bad internet environment, client video quality will be bad.
- Client PC needs more CPU and memory resource to process multiple video decoding.
- High video traffic makes problem on network and switch

AddPac Video Traffic Optimizer™ Technology

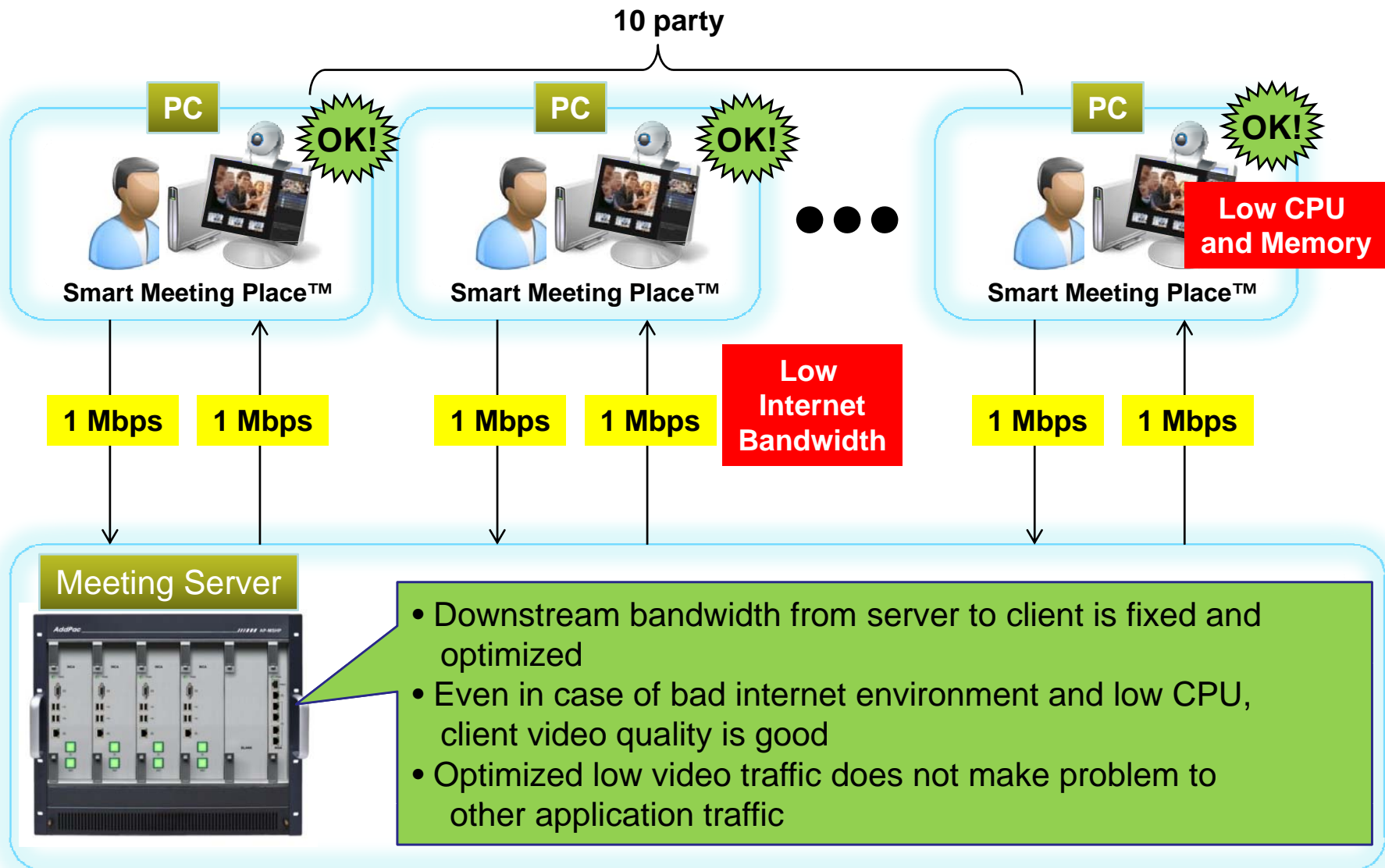

Video Traffic Optimizer™ with Flexible Layout

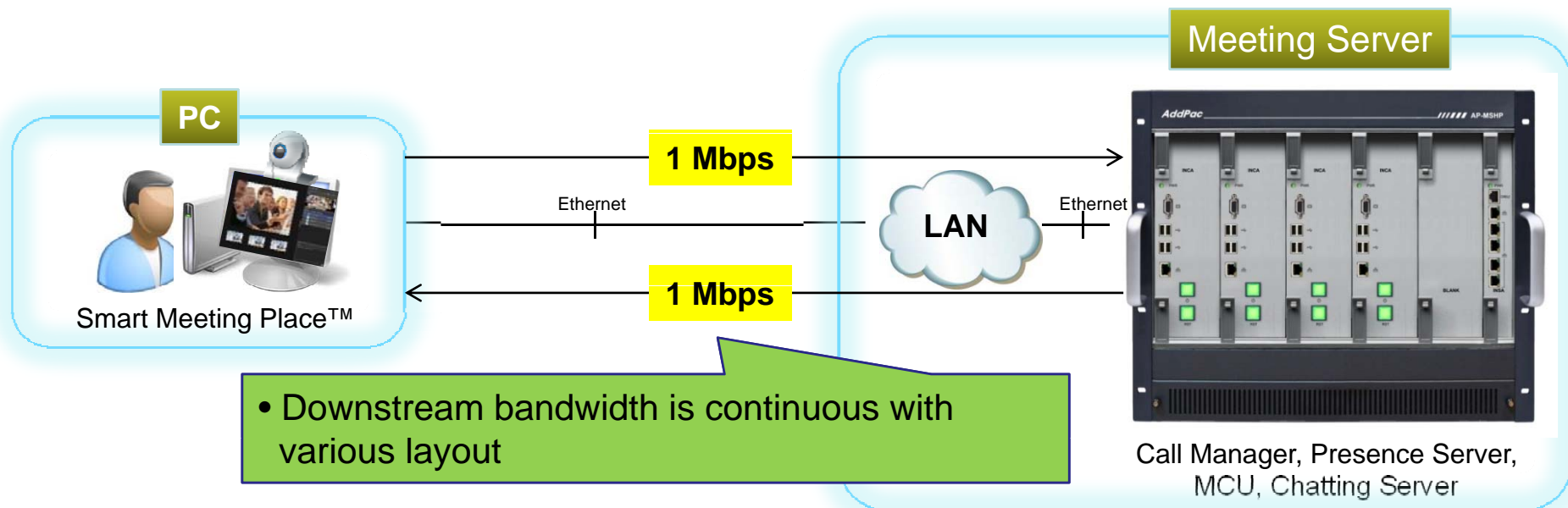
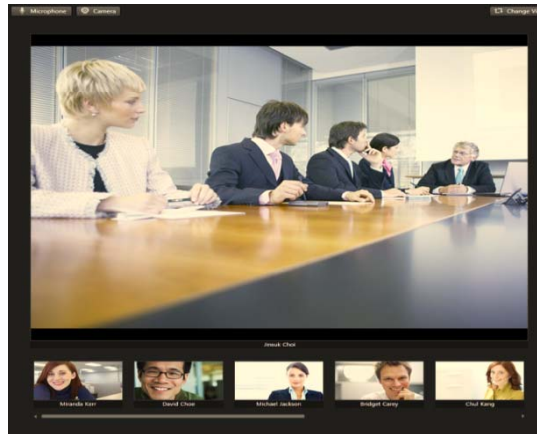
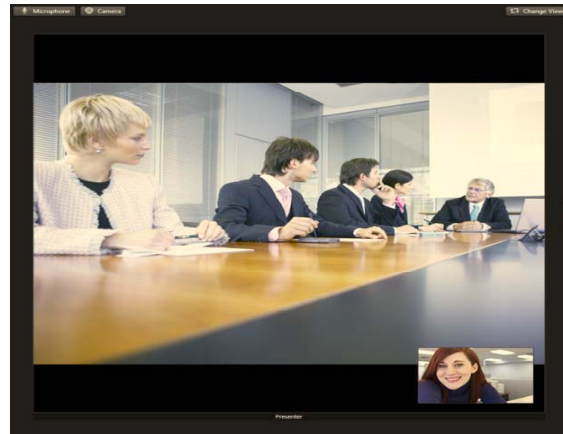



Smart Desktop Meeting Solution Application

Smart Desktop Meeting Solution Applications

- Large Scale HD Video Conference
 - Government and Enterprise Video Conference with [HD Hardware Codecs](#) and [Video Phones](#)
 - Support Standard [H.323](#), [SIP](#) for Interworking to other Vendors
- Education and Training
 - Support [Speech Mode Dual Layout](#) for Teacher and Student differently
 - Support [Audience](#) Mode for Attendees who are Listening only
- Smart Work and Collaboration
 - Support Flexible [Desktop Sharing](#) and Control
 - Useful to Co-Work, Technical Support, Video Consulting
- Healthcare
 - Interworking to HD Codec on Cart with [Dual PTZ Camera Control](#)
- Open Meeting to Anybody (Webinar)
 - Support [Open Meeting](#) with or without password
 - Anonymous attendees join to [webinar](#) by E-Mail or other Link

Smart Desktop Meeting Solution Applications

HD Video Conference

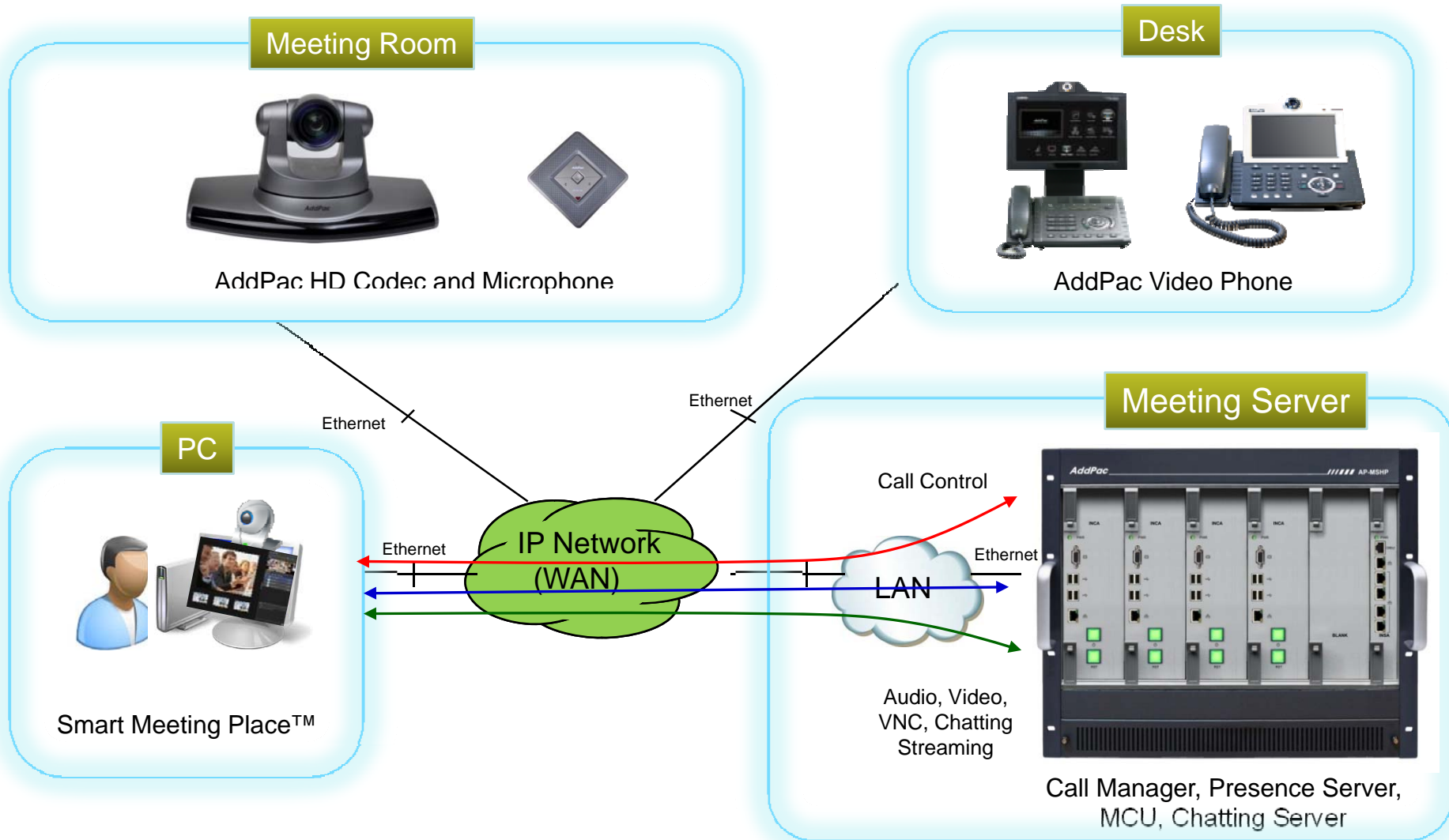

Smart Desktop Meeting Solution Applications

Education and Training

Teacher see students screen



Students see teacher screen



Provides dual layouts for speech mode meeting

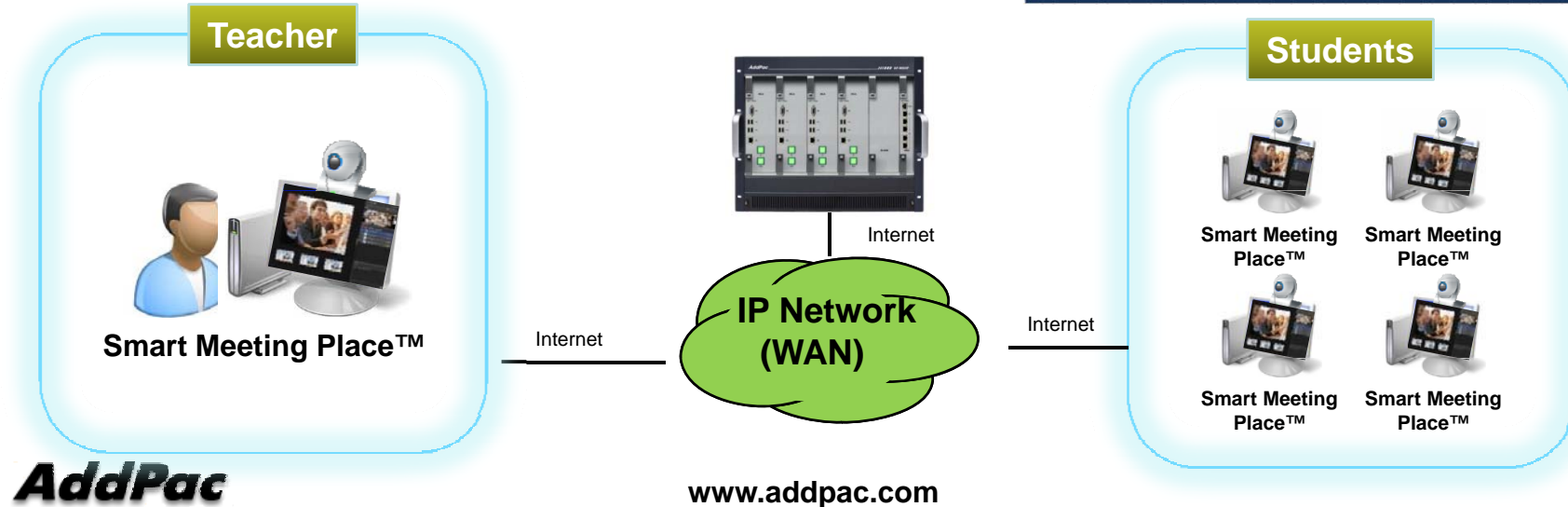

Smart Desktop Meeting Solution Applications

Smart Work and Collaboration

Presenter share his desktop

Co-workers collaborate application

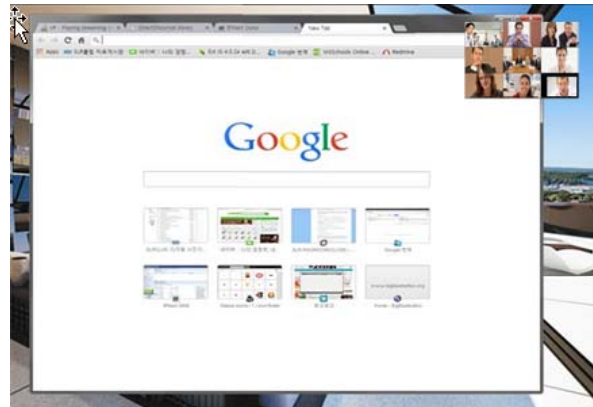

- Co-editing a file
- Co-work any PC application
- Flexible mouse and keyboard control

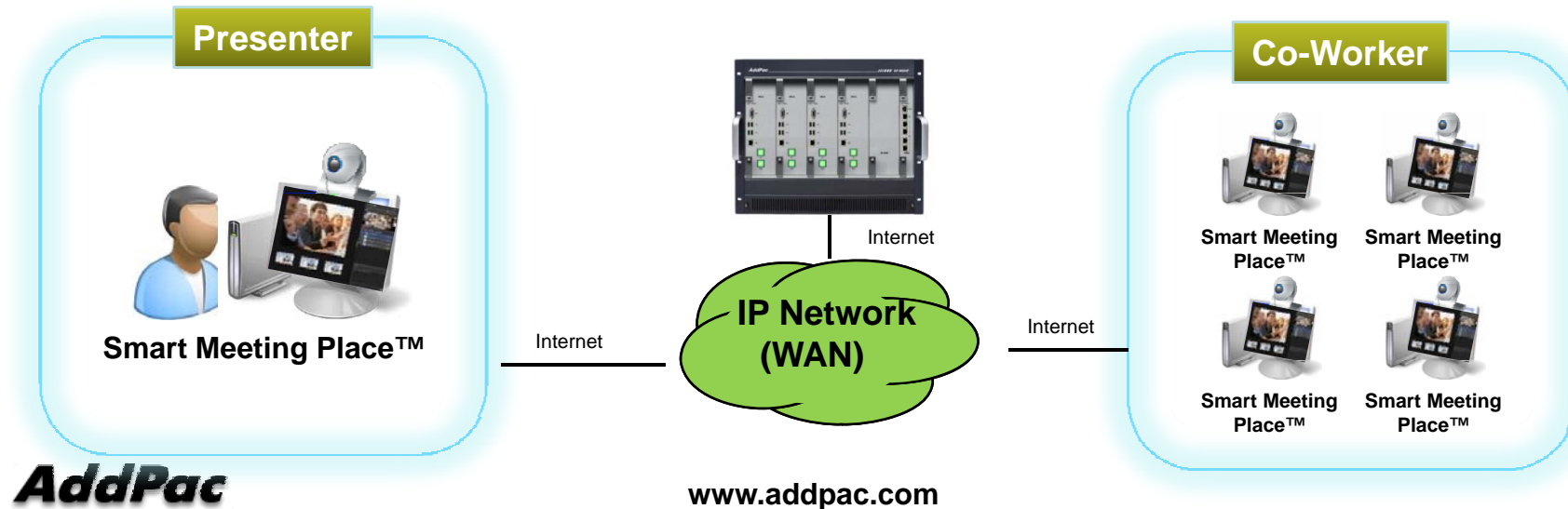
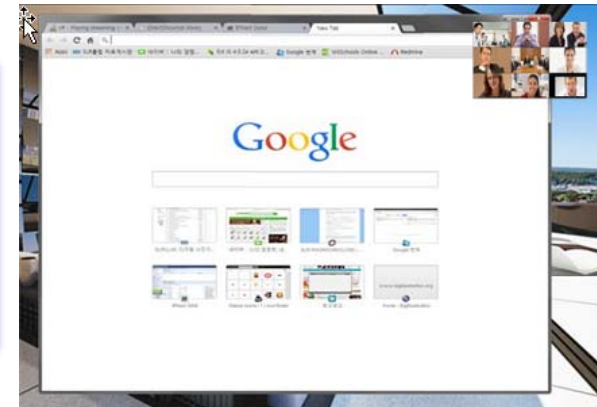

Smart Desktop Meeting Solution Applications Healthcare

Patient seek medical care

Doctor care patient with PTZ camera



- HVC1000 Codec provides HD dual camera with PTZ control
- Patient consult to doctor with face to face

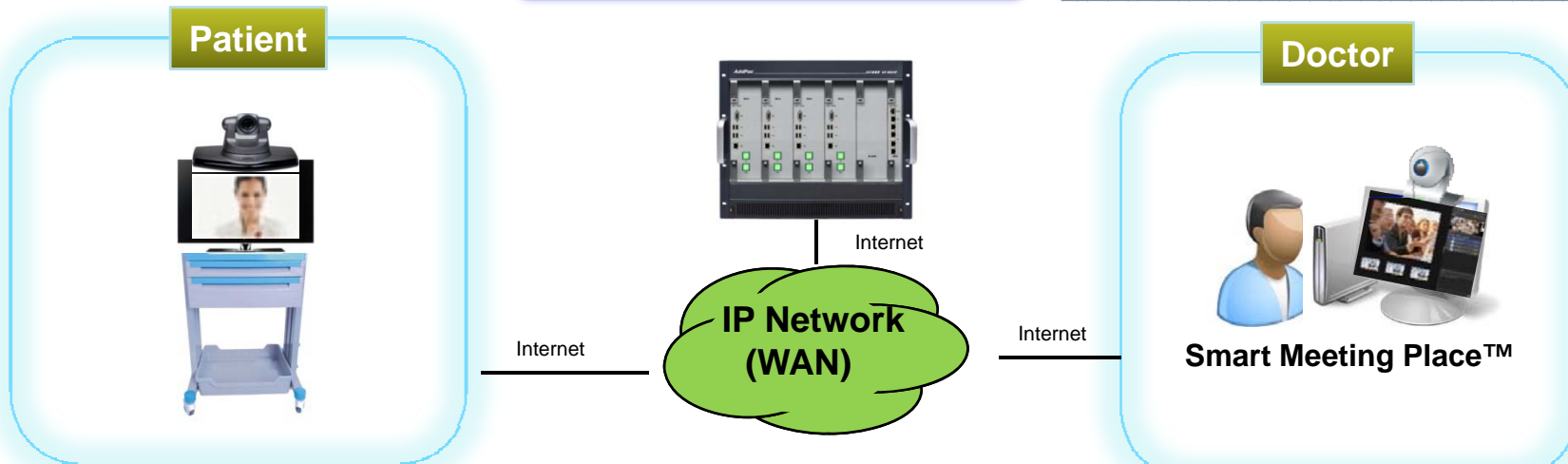
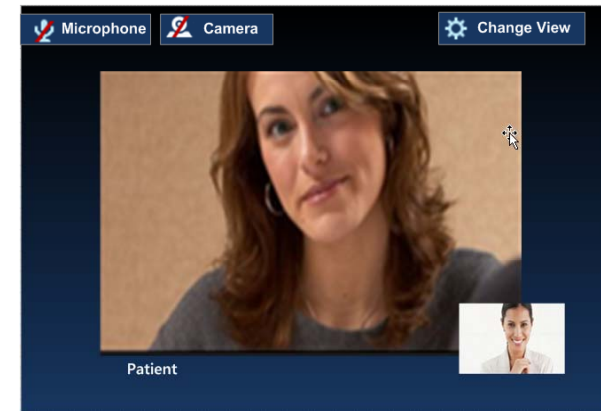

AddPac

www.addpac.com



Smart Desktop Meeting Solution Components



Smart Meeting Scheduler

Smart Meeting Scheduler™

- Making and Starting a Meeting
 - In case of **Immediate** Meeting, host can make and start a meeting at once
 - In case of **Scheduled** Meeting, host can make a meeting with **recursively** or not and then start the meeting later
- Join to the Meeting
 - After start a meeting by host, **attendees** can **join** to the meeting at Smart Meeting Scheduler™
- Support Meeting Board
 - Additionally, we support meeting **board** for uploading meeting **materials** and **comments** by host and attendees
- Support Meeting Template
 - For easy making a meeting, we support meeting **template** as **meeting group**

Smart Meeting Scheduler™

Make/Start/Join Procedure

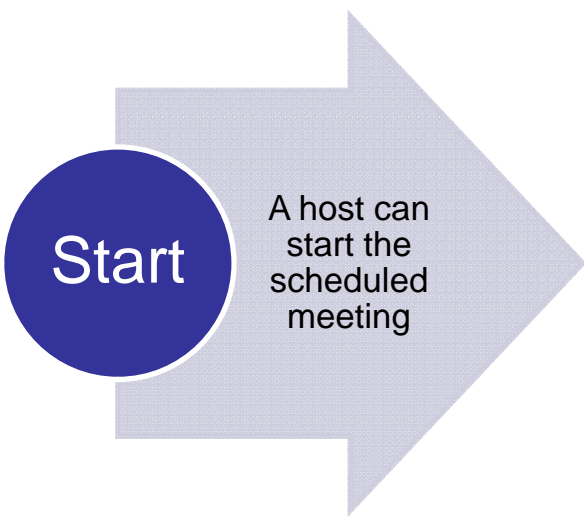
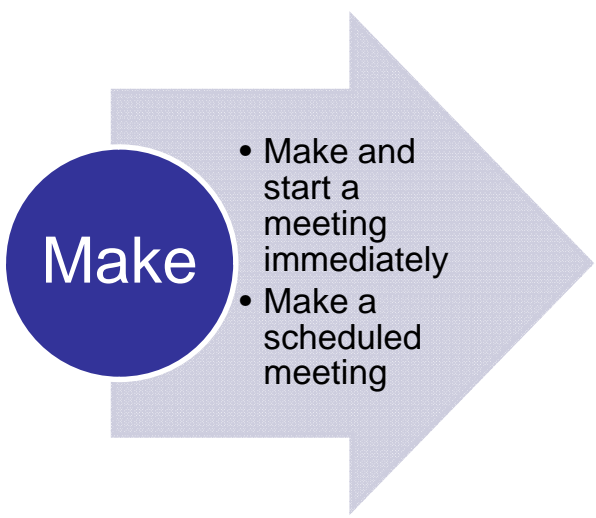

Smart Meeting Scheduler™

Home Page

The screenshot shows the Smart Meeting Scheduler interface. At the top, the user is identified as 'bridget carey(1000)'. The main content area is divided into several sections:

- Navigation:** Home, My Meetings, Calendar, Meeting Group, Meeting History.
- Current Date and Time:** Wednesday 27, 09:24 AM.
- Notice:** A list of recent meeting events:
 - 9/27 14:26 meeting [tech addpac] started, please join the meeting
 - 9/27 14:25 immediate meeting [issue tracking] started. join the meeting now.
 - 8/29 14:53 meeting [project issues] will be started at 2013-09-27 14:00:00
- Today's Meeting:** A table listing current meetings:

Title	Host	Participants
anytime meeting(0/4) Anytime Meeting	suji lora(1000)	lee changsoo(1001), park suji(1003), jung in(1004)
test(0/3) 10/8/2013 4:41:22 PM(1 hour)	bridget carey(1000)	bridget carey(1000), lee changsoo(1001)
regular weekly meeting(0/2) 11/27/2013 5:49:12 PM(1 hour)	bridget carey(2000)	james rott(2200)
- This week meeting list:** A calendar view for Nov 24 — 30 2013, showing a meeting scheduled for Wednesday, Nov 27, from 7 am to 1 pm.

Callouts highlight key features: 'Start a meeting now' (with buttons for 'start a meeting' and 'schedule a meeting'), 'Meeting Notice', 'Today's meeting list', and 'This week meeting list'.

Smart Meeting Scheduler™

Start a Meeting Immediately

The screenshot displays the 'Smart Meeting Scheduler' web application interface. The top navigation bar includes the site name and user information. A sidebar on the left contains menu items like Home, My Meetings, Calendar, Meeting Group, Meeting History, and Notice. The main content area features a 'Start a meeting now' section with a 'Start' button (circled in red and labeled '3') and a 'Cancel' button. Below this is a form for creating a meeting, with a red box labeled '2' encompassing the entire form area. The form includes fields for Title (*), Meeting Group, Participants, Agenda, Memo, Notification, and Tag. A yellow callout box labeled 'Meeting information and settings' points to the form fields. To the right of the form is a 'Participants' list with two entries: 'wykim@addpac.com' and 'bongyong jeong 1006'. A yellow callout box labeled 'Attendees' points to this list. A yellow callout box at the top right explains that fields can be specified to start a meeting immediately and that the system will send invitation messages. A yellow callout box labeled '1' points to the 'start a meeting' button in the sidebar. The footer contains the AddPac logo, copyright information, and version number.

Smart Meeting Scheduler
www.addpac.com

bridget carey(1000)

Start a meeting now
You can specify some field and start a new meeting immediately. Meeting system will invite message for the participants.

Start Cancel

1 start a meeting >

2

3

Meeting information and settings

Attendees

AddPac
Copyright © AddPac 1999-2013 All Rights Reserved
Version: 1.0.130828

Smart Meeting Scheduler™

Making a Scheduled Meeting

The screenshot displays the 'Smart Meeting Scheduler' web application interface. The main content area is titled 'Schedule a meeting' and includes a 'Save' button (circled with a '3') and a 'Cancel' button. A yellow callout box explains: 'You can schedule a one-time meeting or a recurring meeting that occur repeatedly such as regular weekly meeting on Monday.' The form fields include: Title (*): 'Weekly sales meeting'; Meeting Group: 'sales plan group'; Participants: 'E-Mail or Number' with a '+' button and 'Directory' link; Anytime Meeting: ; Start (*): '2013-11-27' and '9:29 AM'; Duration (*): '0' hour and '0' min; Recurrence: ; Radio buttons for 'Daily', 'Weekly' (selected), and 'Monthly'; Weekly checkboxes for days 1-6 (all checked) and Sun-Sat (all unchecked); Monthly: '0' day of the month; End: and '2013-11-27'; Agenda: A yellow callout box labeled 'Meeting schedule' points to this field; Memo: An empty text area. On the left sidebar, the 'schedule a meeting' button is circled with a '1'. The 'Participants' panel on the right shows a list of attendees: 'jung in SWB 1027', 'alan kim 1010', and 'sang lee 1100', with a yellow callout box labeled 'Attendees' pointing to the list. The footer contains 'AddPac', 'Copyright © AddPac 1999-2013 All Rights Reserved', and 'Version: 1.0.130828'.

Smart Meeting Scheduler™

Start / Join to the Meeting

The screenshot displays the 'Smart Meeting Scheduler' web application. The interface includes a navigation sidebar on the left with options: Home, My Meetings, Calendar, and Meeting Group. The main content area is titled 'My Meetings' and shows a list of meetings. The user is identified as 'bridget carey(1000)'. The meeting list is filtered by 'test', 'addpac', and 'Marketing'. The meetings are listed in a table with columns for Title, Host, and Participants. Callouts highlight specific meeting types and actions: 'Anytime Meeting' (orange icon), 'Meeting in Progress' (blue play icon), and 'Scheduled Meeting' (calendar icon). Specific actions are also highlighted: 'Join by attendee' (blue plus icon) and 'Start by Host' (blue play icon).

Title	Host	Participants
anytime meeting(0/4) Anytime Meeting	suji lora(1000)	lee changsoo(1001), park suji(1003), j...
Technical support training(0/6) 11/27/2013 9:41:11 AM(1 hour)	bridget carey(1000)	choi jinseok(1005), choi jinseok SC(1007), meeting_room SWB(1008), seonghyun lee(3333), jung in SWB(1027)
regular weekly meeting(0/2) 12/2/2013 5:49:12 PM(1 hour)	bridget carey(2000)	james rott(2200)
Marketing meeting(0/6) 12/2/2013 6:30:00 PM(1 hour)	bridget carey(1000)	choi jinseok SC(1007), meeting_room SWB(1008), se... lee(3333), jung in SWB(1027), alan kim(1010)
Scheduled Meeting 1(0/5) 12/3/2013 12:00:00 AM(1 hour)	bridget carey(1000)	lee changsoo(1001), park suji(1003)
regular weekly meeting(0/2) 12/3/2013 5:49:12 PM(1 hour)	bridget carey(2000)	james rott(2200)

Smart Meeting Scheduler™

Meeting Board

The screenshot displays the 'Smart Meeting Scheduler' Meeting Board interface. The top navigation bar includes 'Home', 'My Meetings', 'Calendar', 'Meeting Group', 'Meeting History', and 'Notice'. Two main action buttons are visible: 'start a meeting' and 'schedule a meeting'. The main content area is divided into several sections:

- Meeting Information:** A yellow callout box at the top right explains that this is the meeting board for getting information, writing comments, or downloading materials. It notes that the meeting host can start a meeting here and attendees can join. A yellow callout box labeled 'Meeting information' points to the 'Agenda' section, which lists: 1. Training purpose presentation by Choi, 2. Oversea training by Lee, and 3. Discussion. The 'Memo' section contains the text: 'This is the second training meeting'.
- File Upload:** A yellow callout box labeled 'Uploaded File' points to the 'File' section, which includes a file upload input field and a 'File Upload' button.
- Comments and Events:** A yellow callout box labeled 'Comments and events' points to the 'Comment & Event' section. It shows two comments from 'bridget carey' dated 10/27 09:42 and 10/27 09:43. The first comment says 'Please download presentation file before start this meeting' and the second says 'If anybody has discussion issue, please inform to me ASAP.' There is an input field for 'Input the comment.' and a 'Write' button.
- Attendees:** A yellow callout box labeled 'Attendees' points to the right-hand side of the interface, which lists several participants with their names and IDs: bridget carey 1000, choi jinseok 1005, choi jinseok SC 1007, meeting_room SWB 1008, seonghyun lee 3333, and jung in SWB 1027.

The footer of the interface includes the 'AddPac' logo, the website 'www.addpac.com', the copyright notice 'Copyright © AddPac 1999-2013 All Rights Reserved', and the version number 'Version: 1.0.130828'.

Smart Meeting Scheduler™

Calendar View

Smart Meeting Scheduler
www.addpac.com

bridget carey(1000)

Home
My Meetings
Calendar
Meeting Group
Meeting History
Notice

start a meeting >
schedule a meeting >

November 2013

Sun	Mon	Tue	Wed	Thu	Fri	Sat
27	28	29	30	31	1	2
3	4	5	6	7	8	9
10	11	12	13	14	15	16
17	18	19	20	21	22	23
24	25	26	27	28	29	30
1	2	3	4	5	6	7

9:41a Technical support training
5:49p regular weekly meeting

5:49p regular weekly meeting

5:49p regular weekly meeting

5:49p regular weekly meeting

5:49p regular weekly meeting

Click to enter the Meeting Board

AddPac
Copyright © AddPac 1999-2013 All Rights Reserved
Version: 1.0.130828

Smart Meeting Scheduler™

Meeting Group as Meeting Template

Smart Meeting Scheduler
www.addpac.com

bridget carey(1000)

Home
My Meetings
Calendar
Meeting Group
Meeting History
Notice

start a meeting >
schedule a meeting >

Meeting Group
Define meeting participants and a meeting group can be very useful for creating meeting templates.

+ Add

Title	Participants		
Marketing Description	bridget carey(1000), 유 희열(1001)		
addpac week group addpac	wykim@addpac.com, bongyong jeong(1006)		
sales plan group 영업 기획 미팅 그룹	bridget carey(1000), 유 희열(1001)		
test	suji lora(1000), lee changsoo(1001), park suji(1003)		
test group	suji lora(1000), lee changsoo(1001), park suji(1003)		

AddPac
Copyright © AddPac 1999-2013 All Rights Reserved
Version: 1.0.130828

Smart Meeting Scheduler™

Advanced Options - General

The screenshot displays the 'Smart Meeting Scheduler' web application interface. The left sidebar contains navigation links: Home, My Meetings, Calendar, Meeting Group, Meeting History, and Notice. The main content area is titled 'General' and includes the following settings:

- Conference Mode:** A dropdown menu set to 'Meeting'. A callout box explains: 'Conference Mode - Meeting Mode: All participants see same layout - Speech Mode: Floor see all audience but audience see floor only'.
- Speaker:** A dropdown menu set to 'All Participants'. A callout box explains: 'Speaker Mode - All Participants - Floor + Chair - Floor only'.
- Open Room:** A checkbox that is currently unchecked. A callout box explains: 'Open room option for guests - Password - Max Participants'.
- Room Password:** A text input field with '(4 digits)' next to it.
- Guest Class:** A dropdown menu set to 'Participant'.
- Max Participant:** A text input field.
- Room Number:** A text input field. A callout box explains: 'Room Number : By default, this is assigned automatically but, this can be assigned manually'.
- Close on Chair out:** A checkbox that is currently unchecked.

The interface also shows a user profile 'bridget carey(1000)' in the top right corner and a footer with 'AddPac', 'Copyright © AddPac 1999-2013 All Rights Reserved', and 'Version: 1.0.130828'.

Smart Meeting Scheduler™

Advanced Options - Layout

The screenshot displays the 'Smart Meeting Scheduler' application interface. The top navigation bar includes 'Home', 'My Meetings', 'Calendar', 'Meeting Group', 'Meeting History', and 'Notice'. The main content area is divided into three tabs: 'General', 'Layout', and 'Media Class'. The 'Layout' tab is active, showing the 'Layout Mode' dropdown set to 'Manual' and a 'Video Layout' preview area. A yellow callout box titled 'Layout Mode' lists three options: 'Auto-Symmetric', 'Auto-Asymmetric', and 'Manual'. A 'Choose an video layout' dialog box is open, displaying a grid of 48 different layout icons, each labeled with the number of participants it supports (e.g., 2자, 3자, 4자, 5자, 6자, 7자, 8자, 9자, 10자, 12자, 13자, 14자, 16자 (4x4), 17자, 18자, 21자, 22자, 25자 (5x5), 26자, 29자, 34자, 36자 (6x6), 49자, 64자 (8x8)). The dialog has 'OK' and 'Cancel' buttons. The right sidebar shows settings for 'User Class' (Chair), 'Dial-out', 'Position', 'Display Name', and 'Media Class' (Large). The bottom of the interface includes the 'AddPac' logo, copyright information, and the version number '1.0.130828'.

Smart Meeting Scheduler
www.addpac.com

bridget carey(1000)

Home
My Meetings
Calendar
Meeting Group
Meeting History
Notice

start a meeting >
schedule a meeting >

General Layout Media Class

Layout Mode: Manual

Video Layout

Choose an video layout

2자 3자 3자 3자 4자 (2x2) 4자 4자 4자 5자
5자 6자 6자 7자 7자 8자 9자 (3x3) 9자 9자
10자 10자 12자 13자 14자 16자 (4x4) 17자 18자 18자
21자 21자 22자 22자 25자 (5x5) 26자 29자 34자
36자 (6x6) 49자 64자 (8x8)

OK Cancel

User Class: Chair
Dial-out
Position
Display Name
Media Class: Large

jung in SWB 1027
User Class: Chair
Dial-out
Position
Display Name
Media Class: Large

AddPac
Copyright © AddPac 1999-2013 All Rights Reserved
Version: 1.0.130828

Smart Meeting Scheduler™

Advanced Options - Layout

Floor Control

- Floor switching by voice activation
- Floor Position: Fixed or Dynamic
- Floor Assign Mode
- Floor to Full Screen Mode

Participant Name Display

- Position
- Size

Miscellaneous Layout Options

- Background Color and Line
- Border Line and Color
- Floor Line and Color
- Hide Message
- Hide Indicator

Smart Meeting Scheduler™

Advanced Options – Media Class

Smart Meeting Scheduler
www.addpac.com

bridget carey(1000)

Home
My Meetings
Calendar
Meeting Group
Meeting History
Notice

start a meeting
schedule a meeting

Media Class

General | Layout | **Media Class**

Codec

Audio: G.711U
Video: H.263

Large

Picture Size: QCIF
Bandwidth: 64K
Frame Rate: 9 fps

Middle

Picture Size: QCIF
Bandwidth: 64K
Frame Rate: 9 fps

Small

Picture Size: QCIF
Bandwidth: 64K
Frame Rate: 9 fps

Position
User Class
Display Name

3333
Chair
Chair
large

Copyright © AddPac 1999-2013 All Rights Reserved
Version: 1.0.130828

Codec
- Audio Codec
- Video Codec

Large Size
- Picture Size
- bandwidth
- Frame Rate

Middle Size
- Picture Size
- bandwidth
- Frame Rate

Small Size
- Picture Size
- bandwidth
- Frame Rate



Smart Meeting Messenger

Smart Meeting Messenger™

Invite Notification Procedure

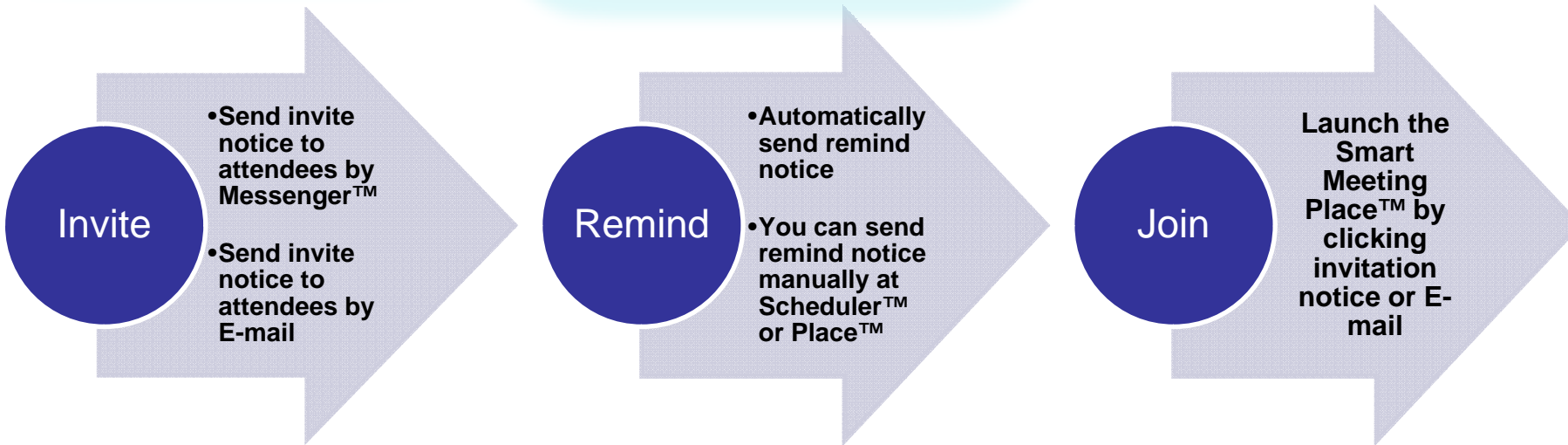
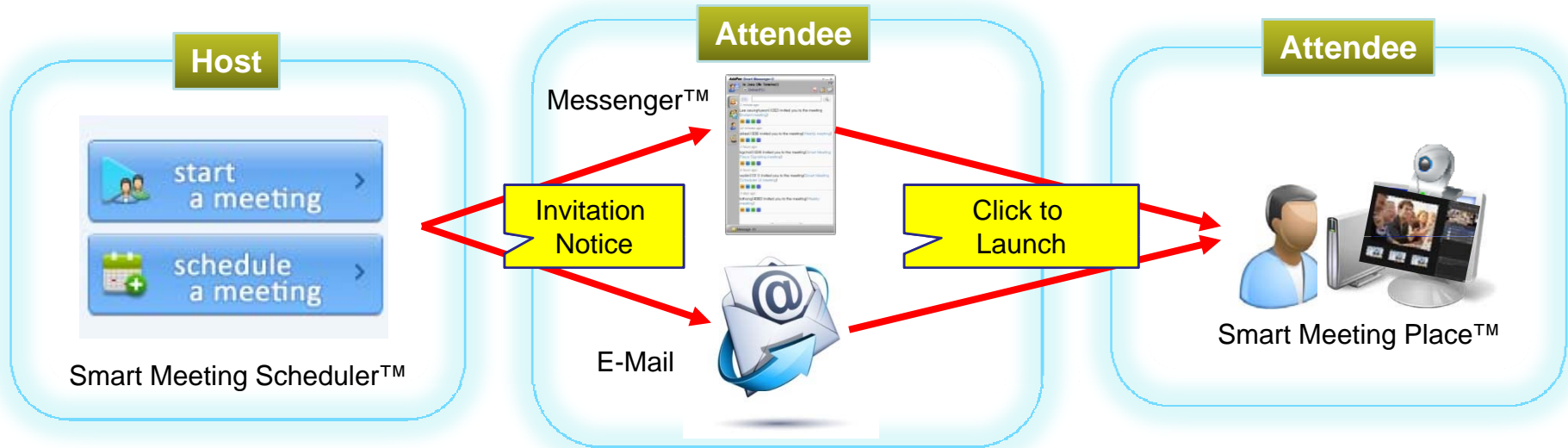

Smart Meeting Messenger™

Meeting Notice

Preview

Join / Start

Meeting board

Receive meeting notice about invitation, scheduled meeting, and etc.

AddPac Smart Messenger III

in jung (No Terminal)
Online(PC)

minute ago
Lee seunghyeon(1032) invited you to the meeting (Instant meeting)

minutes ago
sklee(1009) invited you to the meeting(Weekly meeting)

hours ago
bgchoi(1024) invited you to the meeting(Smart Meeting signaling meeting)

6 hours ago
wykim(1011) invited you to the meeting(Smart Meeting Scheduler UI meeting)

3 days ago
kdhong(4000) invited you to the meeting(Weekly meeting)

Message (0)

Smart Meeting Scheduler

Technical support training

Meeting Group: 102770003 9-4-11 AM
Duration: 1 hour
Title: TFC

Participants: 0/4

Agenda:
1. Training purpose presentation by Chul
2. Device training by Lee
3. Discussion

Comments & Events

1027-0003 10:07:00
Please download presentation for before start this meeting

1027-0003 10:07:00
If any(Any) has discussion break please inform to the A/LM

Smart Meeting Messenger™

Directory and Click to Start Meeting

Click to Start a Meeting Immediately



Smart Meeting Place™

A screenshot of the AddPac Smart Messenger III interface. The window title is "AddPac Smart Messenger III". The user profile at the top shows "James (1000)" with a status of "Online(PC)". Below the profile is a "Phone Book" section containing a hierarchical directory tree. The tree is expanded to show "users", which includes "3F" (with sub-items "Product Design" containing Margaret and William, and "2F" containing "Overseas Sales" with Andrew, Andy, George, Marie, Nicholas, and "Domestic Sales" with Alice, David, Anna, John, Martin, and James). A red box highlights the "Phone Book" area. A yellow callout bubble points to the "Phone Book" header with the text "Directory of your organization". A context menu is open over the "Product Design" folder, listing options: "Start Meeting", "Call", "Call to a Mobile Device", "Call to Home", "Send a SMS", "Send a E-mail", "Conference", "View Profile", and "Add Intra Private Contacts". A red arrow points from the "Start Meeting" option in the context menu to the "Smart Meeting Place™" icon on the left.

Smart Meeting Messenger™ Phone Agent

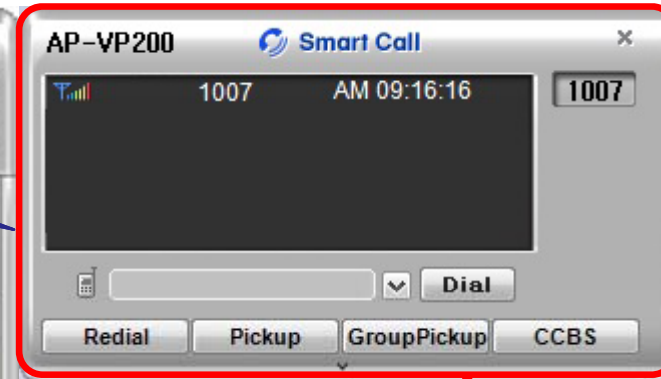
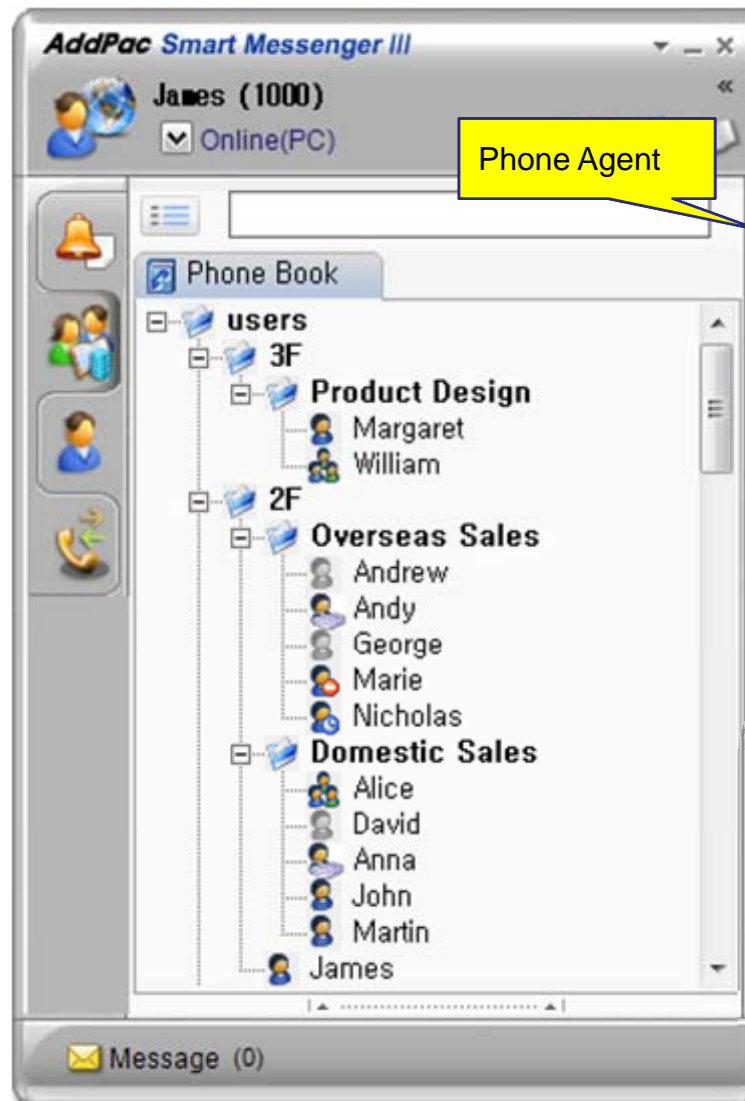

If you have AddPac phone, messenger act as phone agent to receive/send a phone call.

AddPac Phone Terminal





Smart Meeting Previewer

Smart Meeting Previewer™

Preview Procedure

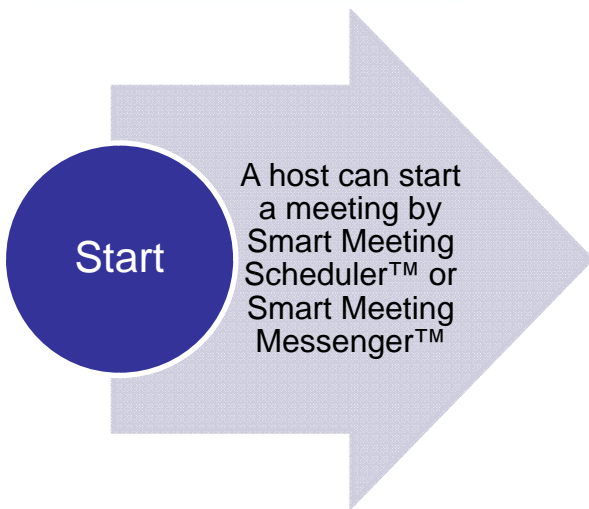

A host can start a meeting by Smart Meeting Scheduler™ or Smart Meeting Messenger™

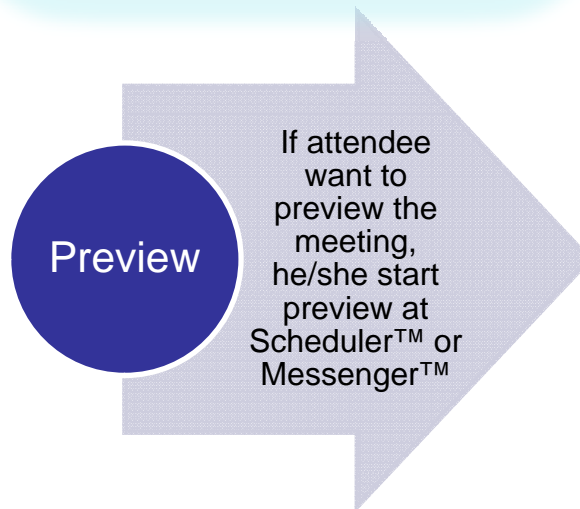

If attendee want to preview the meeting, he/she start preview at Scheduler™ or Messenger™

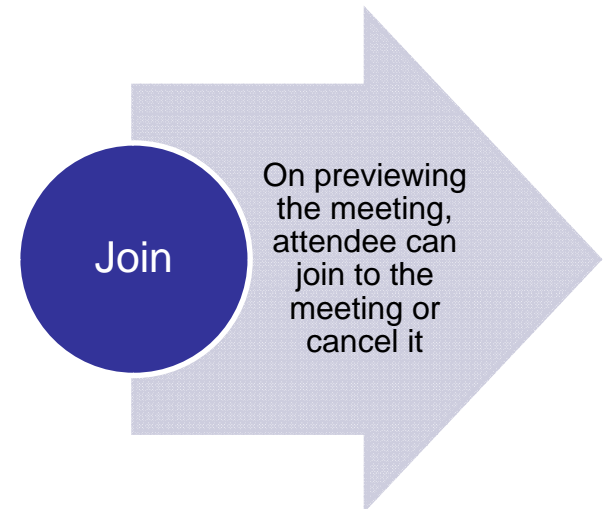

On previewing the meeting, attendee can join to the meeting or cancel it

Smart Meeting Previewer™

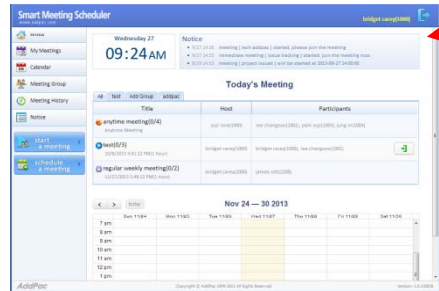

Preview Meeting

Information

Title : New Project requirements and UI design concept of meeting
Host : Hong Gil Dong (2003)
Progress : 1 Hour 12 Min Desktop Sharing : Off

Join Schedule Exit

Participant (10/15)

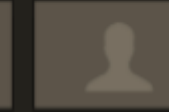
 Hong Gil Dong	 Participant 1	 Participant 2	 Participant 3	 Participant 4
 Participant 5	 Participant 6	 Participant 7	 Participant 8	 Participant 9
 Participant 10	 Participant 11	 Participant 12	 Participant 13	 Participant 14

Meeting information

Thumbnail video of joined participants

Absent attendees



Smart Meeting Place

Smart Meeting Place™

- Easy Installation, Upgrading, Launching
 - It can be installed, upgraded, and launched by web based Smart Meeting Scheduler™
- Flexible Video Conference
 - It supports Symmetric, Asymmetric layouts and various layout mode with Video Traffic Optimizer™ technology
 - Floor (Speaker) can be fixed or dynamic with proper layout control
- Desktop Share
 - It supports presenter's desktop screen to participants
 - Presenter can be assigned by host or request by himself
- Application Share
 - Any kind of application in desktop such as Web, PowerPoint, Word can be shared by selecting running application
- Remote Desktop Control
 - For collaboration and remote desktop technical support, flexible mouse and keyboard control can be supported

Smart Meeting Place™

Full Screen Video Mode – Invite and Remind

The screenshot displays a video meeting interface. At the top, there are controls for Microphone and Camera, and a 'Change View' button. The main area shows a video feed of a woman with short blonde hair. Overlaid on this is a 'Invite Participants' dialog box with tabs for 'Email', 'Phone', and 'Remind'. The 'Email' tab is active, showing an 'Email address' field with a placeholder '(ex) person1@addpac.com;person2@addpac.com...' and a 'Send Invite' button. A yellow callout box points to the dialog with the text: 'Invite a new participant or remind absent participants by e-mail or phone number'. On the right side, there is a 'Participants' list with buttons for 'Invite', 'Lock', and 'Setting'. A yellow callout box points to the 'Invite' button in the list with the text: 'Invite'. Below the participants list is a 'Chat' window with a message from 'Jinsuk Choi' saying 'Meeting started.' and a question 'What's the subject of this meeting?' followed by a response 'It may be workbench design review.' At the bottom, there is a row of five video thumbnails for participants: Miranda Kerr, David Choe, Michael Jackson, Bridget Carey, and Chul Kang.

Smart Meeting Place™

Full Screen Video Mode – Panels

The screenshot displays a video conference interface in full-screen video mode. The main area is a large video panel showing a meeting in progress. A yellow callout bubble points to this panel with the text "Video panel".

At the top of the interface, there are controls for "Microphone" and "Camera", and a "Change View" button. The top right corner contains a toolbar with "Share Desktop", "Quality", and "Menu" options.

On the right side, there is a "Participants" panel. A yellow callout bubble points to it with the text "Participants panel". This panel lists participants: "jinsuk Choi" (highlighted), "David choe", "Miranda Kerr", and "Michael jackson". Each name has icons for mute, video off, and a profile picture.

Below the participants panel is a "Chat" panel. A yellow callout bubble points to it with the text "Chatting panel". The chat shows a message from "Jinsuk Choi" saying "Meeting started." and a question "What's the subject of this meeting?". A response from "Jinsuk Choi" says "It may be workbench design review."

At the bottom of the interface, there is a row of five small video thumbnails for participants: "Miranda Kerr", "David Choe", "Michael Jackson", "Bridget Carey", and "Chul Kang". The name "Jinsuk Choi" is also displayed below the main video panel.

Smart Meeting Place™

Full Screen Video Mode – Control Panel

The screenshot shows the Smart Meeting Place control panel in full screen video mode. The interface is divided into several sections:

- Top Bar:** Contains icons for video, participant, and chat, along with standard window controls (minimize, maximize, close).
- Control Buttons:** Includes 'Pause', 'Sharing Area', and 'Menu'.
- Video Section:** Displays a grid of video feeds for participants.
- Participants Section:** Lists participants with 'Invite', 'Lock', and 'Setting' buttons.
- Participant List:** Shows names like 'jinsuk Choi', 'David choe', 'Miranda Kerr', and 'Michael jackson' with icons for mic and camera mute/unmute.

Callout boxes provide the following details:

- Top Bar:**
 - Video on/off
 - Participant on/off
 - Chatting on/off
- Window Controls:**
 - Minimize
 - Close Full Screen or Stop Desktop Share
 - Quit Program
- Share Control Buttons:**
 - Share Desktop
 - Assign Control
 - Request Control
 - Pause / Play
 - Sharing Area
 - Scale (scale 100%, auto)
 - Quality (auto, high, middle, low)
 - Menu (all control menu)
- Participants Section:**
 - Invite Participant
 - Meeting Room Lock/Unlock
 - Meeting Room Setting
- Participant List:**
 - Presenter assign/unassign/request)
 - Floor assign/unassign/request)
 - 1:1 chat
- Mic and Camera Controls:**
 - Mic. mute/unmute
 - Camera mute/unmute

Smart Meeting Place™

Full Screen Video Mode - without Control Panel

Change View



Jinsuk Choi



Miranda Kerr



David Choe



Michael Jackson



Bridget Carey



Chul Kang

Smart Meeting Place™

Full Screen Video Mode - Mixed Layout

 Change View



Smart Meeting Place™

Full Screen Video Mode - Floor only Layout

 Change View



Smart Meeting Place™

Full Screen Desktop Share – Presenter Screen

The screenshot shows a Windows desktop environment with a VNC sharing session. A 'Sharing area' dialog box is open, and a yellow callout box highlights the 'Share Area Selection' options.

Share Area Selection

- Full Desktop
- Select Display (Dual Screen)
- Rectangle Area
- Application

The 'Sharing area' dialog box is also visible, showing the following options:

- Full desktop
- Select display
- Rectangular area
- Application

The dialog box also contains a table with the following data:

Name	Title
smp	Sharing area
chrome	Yahoo - Google Chrome

The background shows a Yahoo! website with various news articles and financial data. The desktop taskbar includes icons for Internet Explorer, Firefox, and other applications. The system tray shows the date and time as Friday, 2013-11-27, 11:22.

Smart Meeting Place™

Full Screen Desktop Share – Panels

The screenshot displays a Windows desktop with a Yahoo! browser window open. The browser shows the Yahoo! homepage with various news articles, weather information for Incheon (37°F, Light Rain), and financial quotes. A mouse cursor is positioned over the browser window. On the right side of the desktop, a meeting interface is visible, consisting of three panels:

- Video panel:** Shows a grid of video thumbnails for participants.
- Participants panel:** Lists participants with their names and status icons. The list includes jinsuk Choi, David choe, Miranda Kerr, and Michael jackson.
- Chatting panel:** Shows a chat window with messages from jinsuk Choi. The messages are: "Meeting started." and "What's the subject of this meeting?". A response from jinsuk Choi says: "It may be workbench design review."

Yellow callout boxes with speech bubble shapes point to each of these three panels, labeling them as "Video panel", "Participants panel", and "Chatting panel".

Smart Meeting Place™

Full Screen Desktop Share – Video only

The image shows a Windows desktop environment with a Yahoo! browser window open. The browser displays the Yahoo! homepage with various news articles, weather information for Incheon, and financial and sports scores. A red-bordered video panel is overlaid on the right side of the browser window, showing a meeting with four participants. A yellow speech bubble points to this panel with the text "Video panel".

Video panel

Yahoo! News Articles:

- Couple Has An Open Marriage So Complicated, It's Hard To Keep Track**
Michael loves his wife, Kamala. Michael also likes his 27-year-old girlfriend, Rachel. So six months ago, Kamala decided to do whatmost wives would never even
Huffington Post
- Dermatologists Say It's Better Than a Facelift**
Women everywhere are saving thousands of dollars on plastic surgery by reducing the appearance of wrinkles from the comfort of their own home.
LifeCell™ Skin Care Sponsored
- Taylor Swift Stuns in Crystal Gown at Winter Whites Gala With Prince William: Pictures**
Taylor Swift stunned in a crystal gown at the Nov. 26 Winter Whites Gala, where she met Prince William -- see a picture!
Us Weekly
- Khloe Kardashian Could Be O.J. Simpson's Daughter, Claims His Manager**
The old rumor that O.J. Simpson is Khloe Kardashian's biological father has reared its ugly head again, as the former professional football player's manager, Norman
Huffington Post
- Frankie Muniz Suffers Another Mini-Stroke**
Frankie Muniz has another health scare as he suffers a second mini-stroke within a year.
Splash News
- Driver offended by "WH0 R8X" license plate**
A Missouri driver did not appreciate the message she saw on the state issued license plate that she recently received.
Odd News
- 49ers linebacker Ahmad Brooks on Robert Griffin III: 'He shouldn't be playing'**
San Francisco 49ers linebacker Ahmad Brooks said what we all have been thinking, but few were willing to deliberate. Washington quarterback Robert Griffin III
Shutdown Corner

Weather: Incheon
37°F Light Rain
Today: 38° 27°
Tomorrow: 36° 27°
Friday: 44° 37°

Quotes Yahoo Finance:

S&P 500	1,802.75	↑	0.01%
NASDAQ Composite	4,017.75	↑	0.58%
Dow Jones Indust...	16,072.80	↑	0.00%

Scores Yahoo Sports:

NBA	BKN 101	TOR 89	3:13 4th
NBA	ORL 85	ATL 73	11:45 4th
NHL	ANH 1	DAL 0	9:26 2nd

System Tray: KO, A, 漢, 2013-11-27, 오전 11:26, 2013-11-27

Smart Meeting Place™

Window Mode - Panels

The screenshot displays the Smart Meeting Place interface in window mode. The main window is titled "Smart Meeting Place" and has a "Start" tab. The interface is divided into several panels, each highlighted with a red border and a yellow callout box:

- Meeting information area:** Located in the top-left, it displays meeting details: Meeting Name: UI Design Seminar, Host: jinsuk Choi, Room Number: 5050, Start Datetime: 2013.08.27 10:00, and Duration: 04:25 (1hour 30min). An "Invite" button with a person icon is also present.
- Video panel:** Located in the top-right, it shows a grid of video feeds for participants.
- Participants panel:** Located in the middle-right, it lists participants: jinsuk Choi, David choe, Miranda Kerr, and Michael Jackson. It includes "Invite", "Lock", and "Setting" buttons.
- Chatting panel:** Located in the bottom-right, it shows a chat window with messages from "Jinsuk Choi": "Meeting started." and "It may be workbench design review." A question "What's the subject of this meeting?" is also visible.
- Audio:** A callout box pointing to the "Audio" section in the bottom-left, which includes a microphone icon and the text "Join voice chatting or configure microphone & speaker."
- Video:** A callout box pointing to the "Camera" section in the bottom-left, which includes a camera icon and the text "Share video with participants or configure camera."
- Desktop sharing:** A callout box pointing to the "Share Desktop" section in the bottom-left, which includes a computer monitor icon and the text "Start desktop share with people who participates in the meeting."

The bottom of the window features the "AddPac" logo and "Audio" and "Camera" icons.

Smart Meeting Place™ Window Mode – Desktop Share

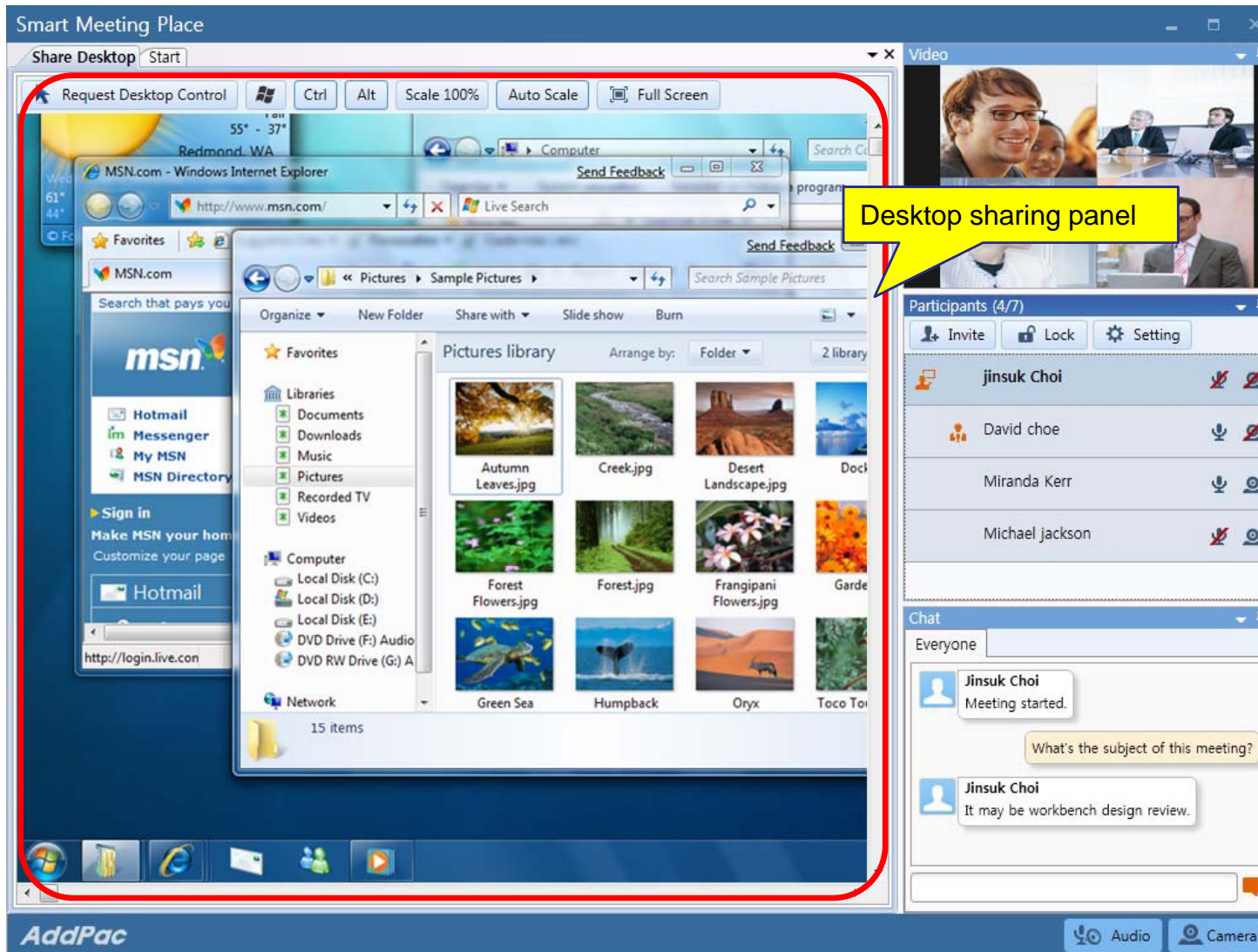



Smart Meeting Server



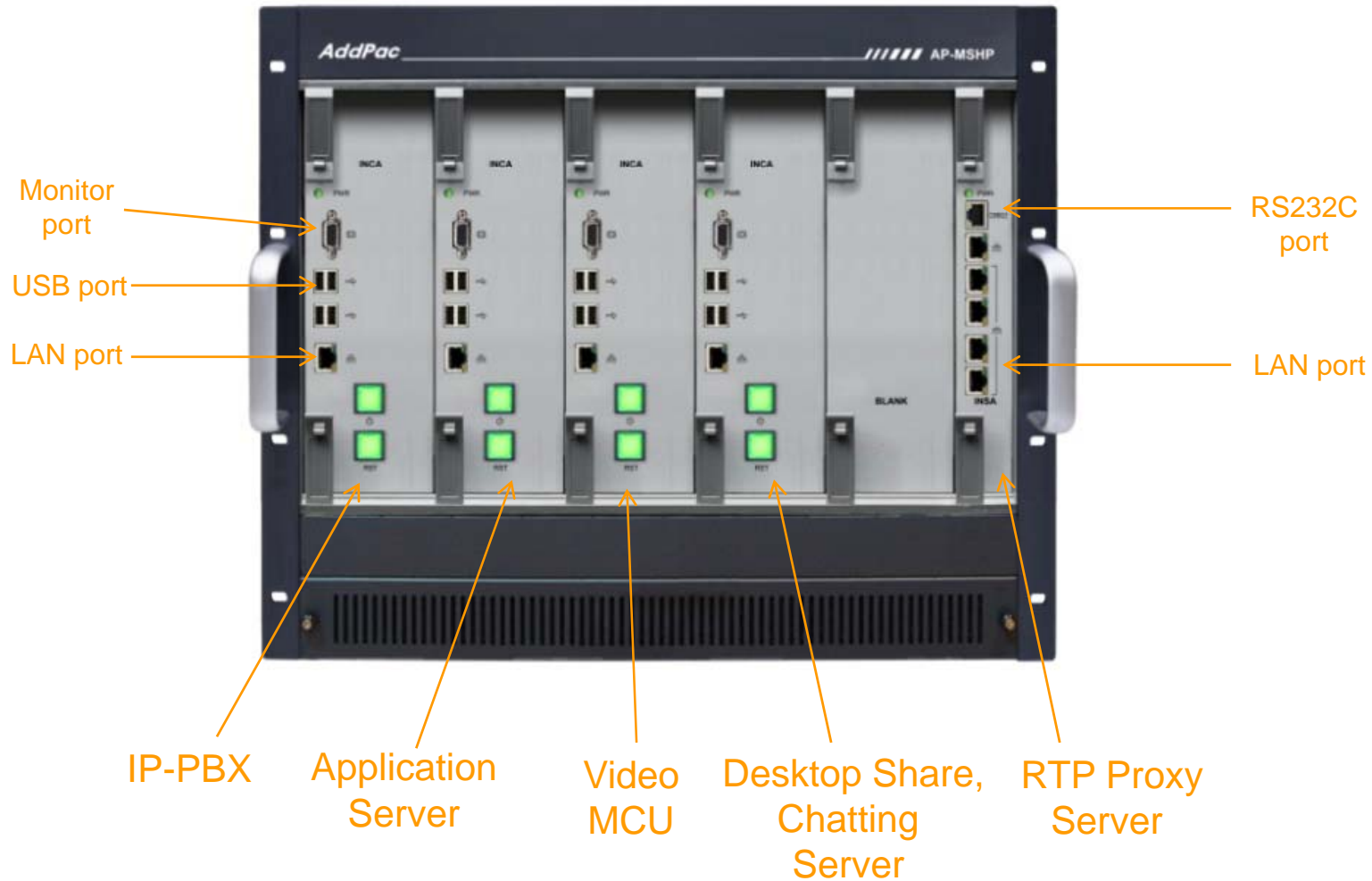

Smart Meeting Server





HD&Full HD Video Conference Device

HD & Full HD Video Conference Devices

Product		AP-HVC1000	AP-HVC700	AP-HVC600	AP-HVC500
					
Camera Sensor		CMOS	CCD	CMOS	CCD
Optical Zoom		x10	x18	x10	x18
Video Resolution		Full HD : 720P, 1080i	HD : 720P(1280x720)	Full HD : 720P, 1080i	HD :720P(1280x720)
Channel One(1)	Video Input	Built-in Full HD Camera	Built-in HD Camera	Built-In Full HD Camera, Composite, HD-SDI, RGB, HDMI	Built-In HD Camera, Composite, HD-SDI, RGB, HDMI
	Video Output	Composite, Component, HDMI	Composite, Component, HDMI	Composite, Component, HDMI	Composite, Component, HDMI
	Audio Input	Stereo RCA Type	Stereo RCA Type	Stereo RCA Type	Stereo RCA Type
	Audio Output	RCA Type Audio (L,R)	RCA Type Audio (L,R)	RCA Type Audio (L,R)	RCA Type Audio (L,R)
PTZ Control		N/A	N/A	Support	Support
Channel Two(2)	Video Input	Composite RCA, HD-SDI, RGB, HDMI	Composite RCA, HD-SDI, RGB, HDMI	N/A	N/A
	Video Output	Composite, Component, HDMI	Composite, Component, HDMI		
	Audio Input	Stereo RCA Type	Stereo RCA Type		
	Audio Output	RCA Type Audio (L,R)	RCA Type Audio (L,R)		
	PTZ Control	Support	Support		
LAN		One(1) 10/100M Ethernet	One(1) 10/100M Ethernet	One(1) 10/100M Ethernet	One(1) 10/100M Ethernet
Power		External Power Adaptor	External Power Adaptor	External Power Adaptor	External Power Adaptor

HD & Full HD Video Conference Devices

Product	AP-HVC200	AP-HVC300
		
Sensor	CCD	CMOS
Optical Zoom	x18	x10
Video Resolution	HD 720P(1280x720)	Full HD 720P, 1080i
Video Output	HDMI Component, RCA	HDMI, Component, RCA
Audio Out	Stereo Left, Right RCA Out	Stereo Left, Right RCA Out
Audio In	MIC/Audio In, 3.5mm Audio Input	MIC/Audio In, 3.5mm Audio Input
LAN	One(1) 10/100M Ethernet	One(1) 10/100M Ethernet
Power	External Power Adaptor	External Power Adaptor



SD Video Conference



SD Video Conference Devices

Product		AP-SVC700	AP-SVC500	AP-SVC200
				
Camera Sensor		CCD	CCD	CCD
Optical Zoom		x27	x27	x27
Codec Video Resolution		SD (D1, VGA)	SD(D1, VGA)	SD(D1, VGA)
Display Video Resolution		HD	HD	HD
Channel One(1)	Video Input	Built-in SD Camera	Built-In SD Camera or Composite	Built-In SD Camera
	Video Output	Composite, Component, HDMI	Composite, Component, HDMI	Composite, Component, HDMI
	Audio Input	Stereo RCA Type	Stereo RCA Type	Stereo RCA Type
	Audio Output	RCA Type Audio (L,R)	RCA Type Audio (L,R)	RCA Type Audio (L,R)
	External PTZ Control	N/A	Support	N/A
Channel Two(2)	Video Input	Composite RCA, RGB, HDMI	N/A	N/A
	Video Output	Composite, Component, HDMI		
	Audio Input	Stereo RCA Type		
	Audio Output	RCA Type Audio (L,R)		
	External PTZ Control	Support		
LAN		One(1) 10/100M Ethernet	One(1) 10/100M Ethernet	One(1) 10/100M Ethernet
Power		External Power Adaptor	External Power Adaptor	External Power Adaptor



Full HD Video Conference Codec





Full HD Video Conference Codecs

Product		AP-HCC2000	AP-HCC1000	AP-HVC500
				
Video Resolution		720P, 1080i(60), 1080p(30)	720P, 1080i(60), 1080p(30)	720P, 1080i(60), 1080p(30)
Channel One(1)	Video Input	Composite RCA, HD-SDI, HDMI	Composite RCA, HD-SDI, HDMI	Composite RCA, HD-SDI, RGB, HDMI
	Video Output	Composite RCA, Component, HDMI	Composite RCA, Component, HDMI	Composite RCA, Component, HDMI
	Audio Input	Stereo RCA Type	Stereo RCA Type	Stereo RCA Type
	Audio Output	RCA Type Audio (L,R)	RCA Type Audio (L,R)	RCA Type Audio (L,R)
PTZ Control		Support, RS232C	Support, RS232C	Support
Channel Two(2)	Video Input	Composite RCA, HD-SDI, RGB, HDMI	Composite RCA, HD-SDI, RGB, HDMI	N/A
	Video Output	Composite RCA, Component, HDMI	Composite RCA, Component, HDMI	
	Audio Input	Stereo RCA Type	Stereo RCA Type	
Audio Output		RCA Type Audio (L,R)	RCA Type Audio (L,R)	
PTZ Control		Support, RS232C	Support, RS232C	
Video MCU		4-Party Video MCU	N/A	N/A
LAN		One(1) 10/100/1000M Gigabit Ethernet	One(1) 10/100/1000M Gigabit Ethernet	One(1) 10/100/1000M Gigabit Ethernet
Power		External Power Adaptor	External Power Adaptor	External Power Adaptor



HD Video Conference Cameras

HD Cameras for Video Conference

Product	AP-HDC50	AP-HDC100	AP-HDC200	AP-HDC300	AP-HDC350
					
Sensor	CCD	CMOS	CCD	CMOS	CMOS
Optical Zoom	x18	x10	x18	x10	x20
Video Resolution	HD 720P(1280x720)	Full HD 720P, 1080i	HD 720P(1280x720)	Full HD 720P, 1080i	Full HD 720P, 1080i, 1080p
Video Output	HDMI, HD-SDI, Component, RCA	HDMI, HD-SDI, Component, RCA	HDMI, HD-SDI, Component, RCA	HDMI, HD-SDI, Component, RCA	HDMI, HD-SDI, Component, RCA
PTZ Control	Support	Support	Support	Support	Support
PTZ Control Interface	RS232/RS485	RS232/RS485	RS232/RS485	RS232/RS485	RS232/RS485
Power	External Power Adaptor	External Power Adaptor	External Power Adaptor	External Power Adaptor	External Power Adaptor



AP-MP100

Acoustic Echo Canceller MIC

Main Features

- Acoustic Echo Canceller Micro Phone Solution for Video Conference
- Wide band(16bits, 16kHz sampling) operation
- Support CNG(comport noise generation) to generate white noise
- Support double talk
- Noise reduction algorithm
- Support HDMI speaker mode & analog speaker mode
- S/W upgrade by y-modem protocol via RS232C
- Support CLI(Command Line Interface) to configure AEC parameters
- Voice Activity Detection
- Mute button
- Status LED (Mute, Active)
- Compact Design & Die Casting
- Power On/Off Switch

Hardware Specification

- DSP based Acoustic Echo Canceller Hardware Architecture
- Status LED (Mute, Active)
- Audio Mute Key Support
- RS232C based Firmware Upgrade Architecture
- Compact Design & Die Casting
- Power On/Off Switch
- MIC Interface
 - Power Input
 - Audio Output



Hardware Specification

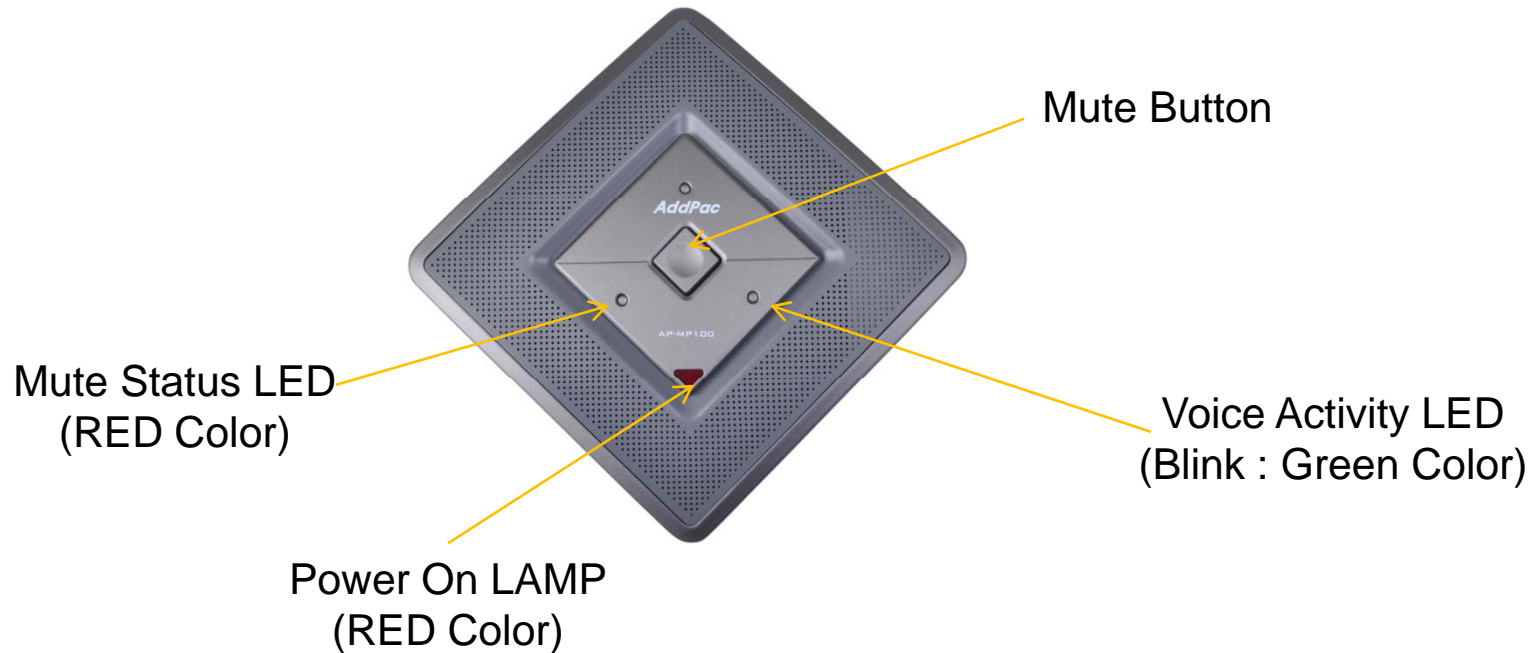



Thank you!

AddPac Technology Co., Ltd.
Sales and Marketing

Phone +82.2.568.3848 (KOREA)

FAX +82.2.568.3847 (KOREA)

E-mail sales@addpac.com