

SIP Video Intercom Call Center Solution



SIP Video Intercom Call Center Solution

- AP-VAC20N SIP Video Intercom
- AP-VAC50N SIP Video Intercom
- AP-ACS1000 Door Access Control Server
- AP-NR1000 IP Recording Server
- AP-VP280DM IP Video Phone
- AP-MSCS GIS Map based Call Center System

[Learn More >](#)

The image displays a collection of hardware components for a SIP Video Intercom Call Center Solution. From left to right, there is a black server rack unit, a black IP video phone with a handset and a small screen showing a video call, two black vertical wall-mounted intercom units with small screens, and a large computer monitor displaying a GIS map with various colored lines and markers. The background is a solid blue color.

AddPac

AddPac Technology

Sales and Marketing

www.addpac.com

Contents

- SIP Video Intercom Call Center Network Diagram
- SIP Video Intercom Comparison Table
 - AP-VAC20N, AP-VAC50N, AP-VAC200N
- Door Access Control Server Solution for Call Center
 - ACS1000, ACS1500, etc
- AP-VP280DM IP Video Phone Solution for Call Center
- AP-NR1500 IP Video Recording Server
- AP-MSCS MAP based SIP Video Intercom Call Center System
- AP-GTR1000 based Embedded NTP Server for Time Sync. (Option)

Network Diagram

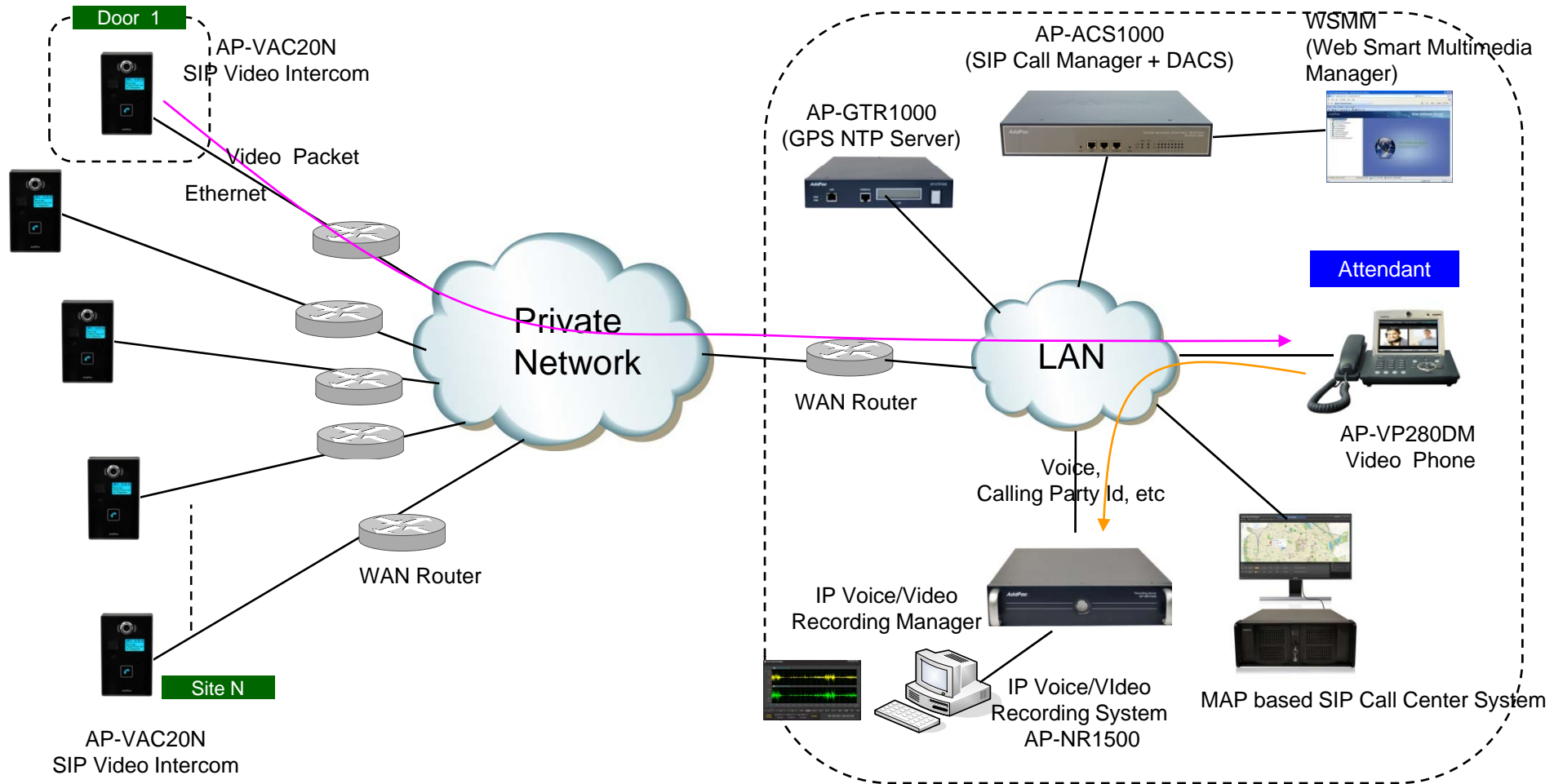



SIP Video Intercom Solution

SIP Video Intercom Comparison Table (One-Touch Call)

Model	AP-VAC200N	AP-VAC50N	AP-VAC20N
Service Features			
Duplex (Voice)	Full Duplex	Full Duplex	Full Duplex
Key Pad	One(1) Call Button	One(1) Call Button	One(1) Call Button
LCD	3.5inch LCD	2inch LCD	Graphic LCD
RF Card	Support	Support	Support
Fingerprint	Support	N/A	N/A
Camera Sensor	SD(VGA)	SD(VGA)	SD(VGA)
Video Codec	SD, H.264/MPEG4	SD, H.264/MPEG4	SD, H.264/MPEG4
Voice Codec	G.711	G.711	G.711
Signaling	H.323/SIP	H.323/SIP	H.323/SIP
MIC & Speaker Phone	Support	Support	Support
LAN Port	1	1	1
PoE (Option)	Support	Support	Support



AP-ACS1000

Door Access Control Server

Contents

- DACS(Door Access Control System) Network Diagram
- AP-ACS1000 DACS Main Features
- AP-ACS1000 DACS Hardware Specification
- DACS System Message Flow (Examples)
- DACM (Door Access Control Manager)
- Open API for Third Party Controller

Integrated Door Access Control and Call Control

AP-ACS1000 DACS (Door Access Control System)

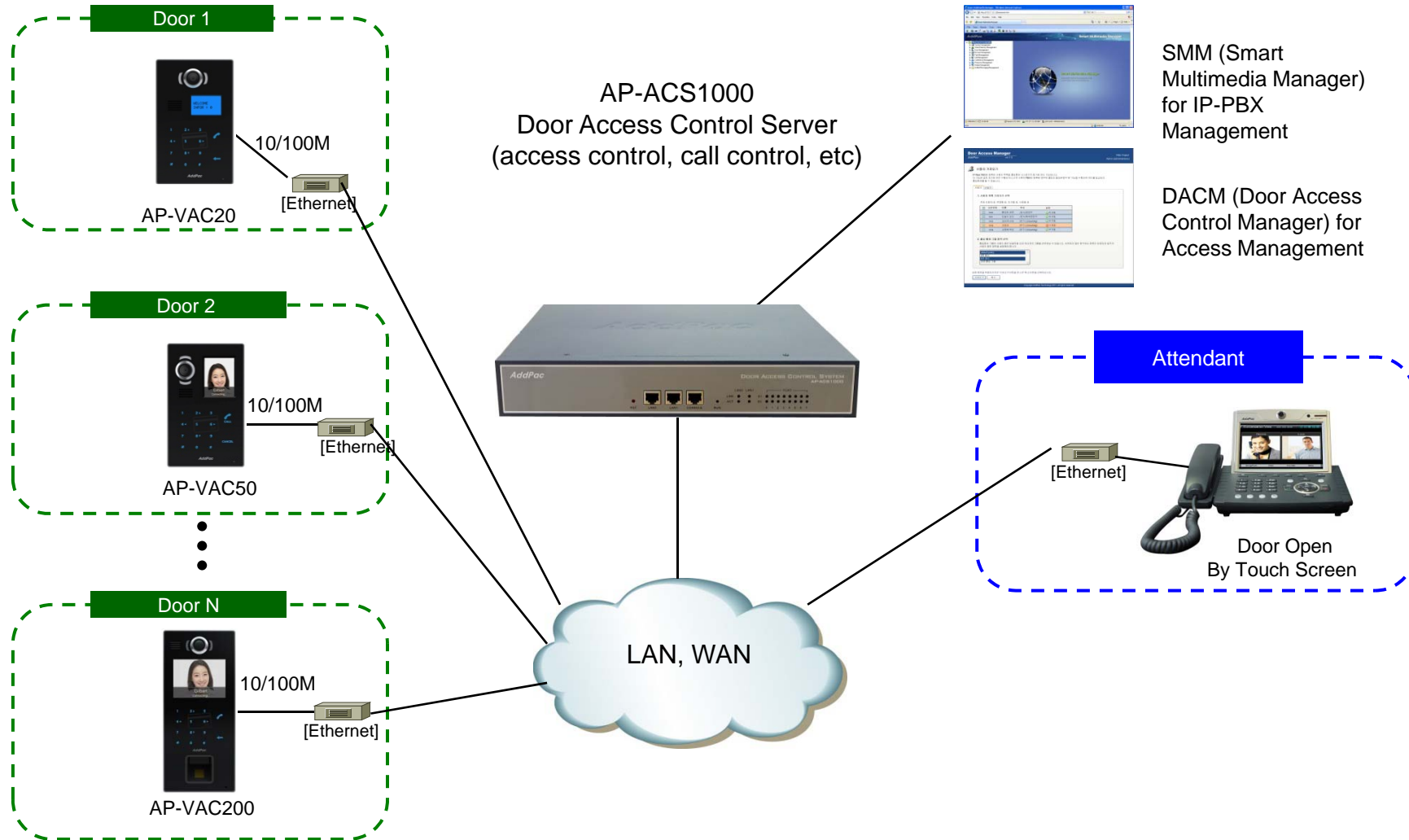

Main Features

AP-ACS1000 DACS (Door Access Control System)

- Door Access Control Application System
- SIP Application Server, Proxy, Registrar and Location Server
- Multiple ITSP Trunk with SIP & H.323 Accounts Support
- Legacy PBX Interworking Service
- High Performance RISC & Programmable DSP Architecture
- Two(2) 10/100Mbps Fast Ethernet (IP Share ,etc)
- High Performance LAN-to-LAN Routing Capability
- Powerful Network Protocols (PPPoE, DHCP, Static Routing, etc)
- IPv4/IPv6 Dual Stack
- Firmware Upgradeable Architecture
- Smart Multimedia Manager for IP-PBX Management
- DACM(Door Access Control Manager)
- Advanced Voice QoS Mechanism
- Small, Light and Compact Design
- Two(2) VoIP Module Slots for Analog, Digital Interface

Main Features

AP-ACS1000 DACS (Door Access Control System)

- RISC Microprocessor Computing Power
- Main Chassis
 - Network Interface
 - Two(2) 10/100Mbps Fast Ethernet
 - One(1) RS-232C Console (RJ45)
 - Two(2) VoIP Module Slots for FXS, FXO etc



Hardware Specification

AP-ACS1000 DACS (Door Access Control System)

AP-ACS1000 Front Side



LAN1 (10/100Mbps)

LAN0(10/100Mbps)

Console Port

www.addpac.com

Hardware Specification

AP-ACS1000 DACS (Door Access Control System)

AP-ACS1000 Back Side

PSTN Interface Module

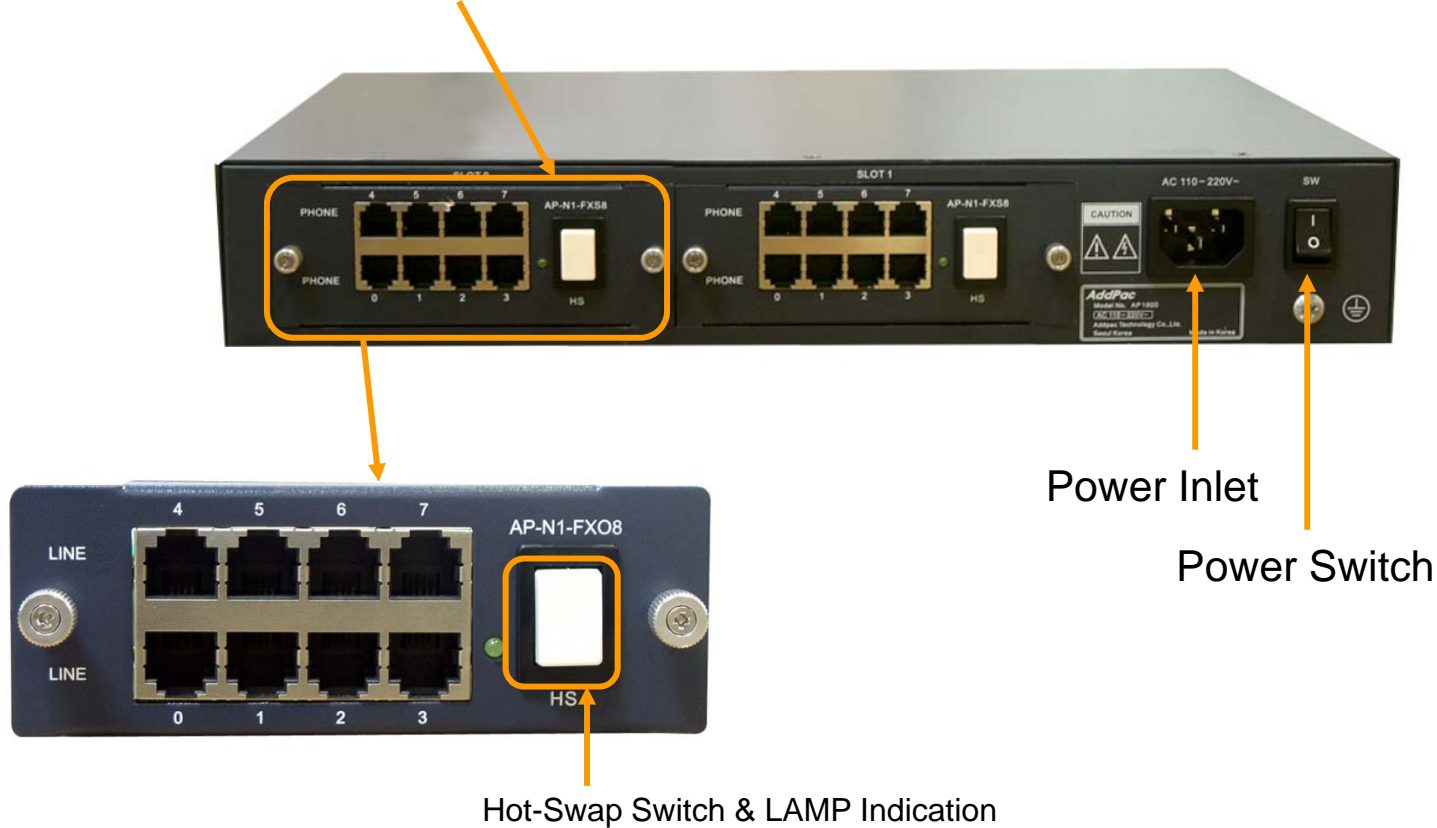



DACS System Message Flow

DACS System Message Flow

Registration and KeepAlive

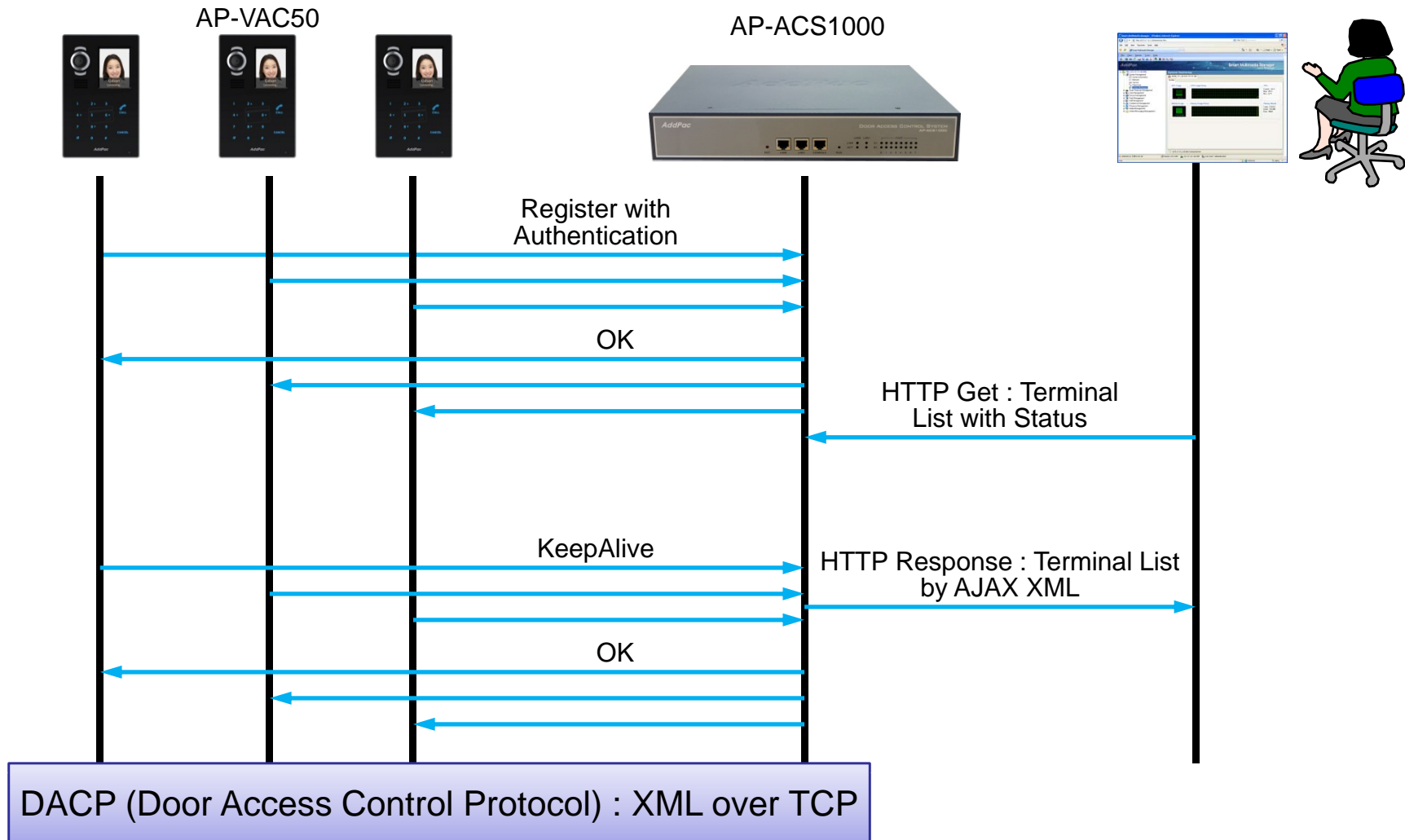

DACS System Message Flow

Access Privilege and Schedule Download

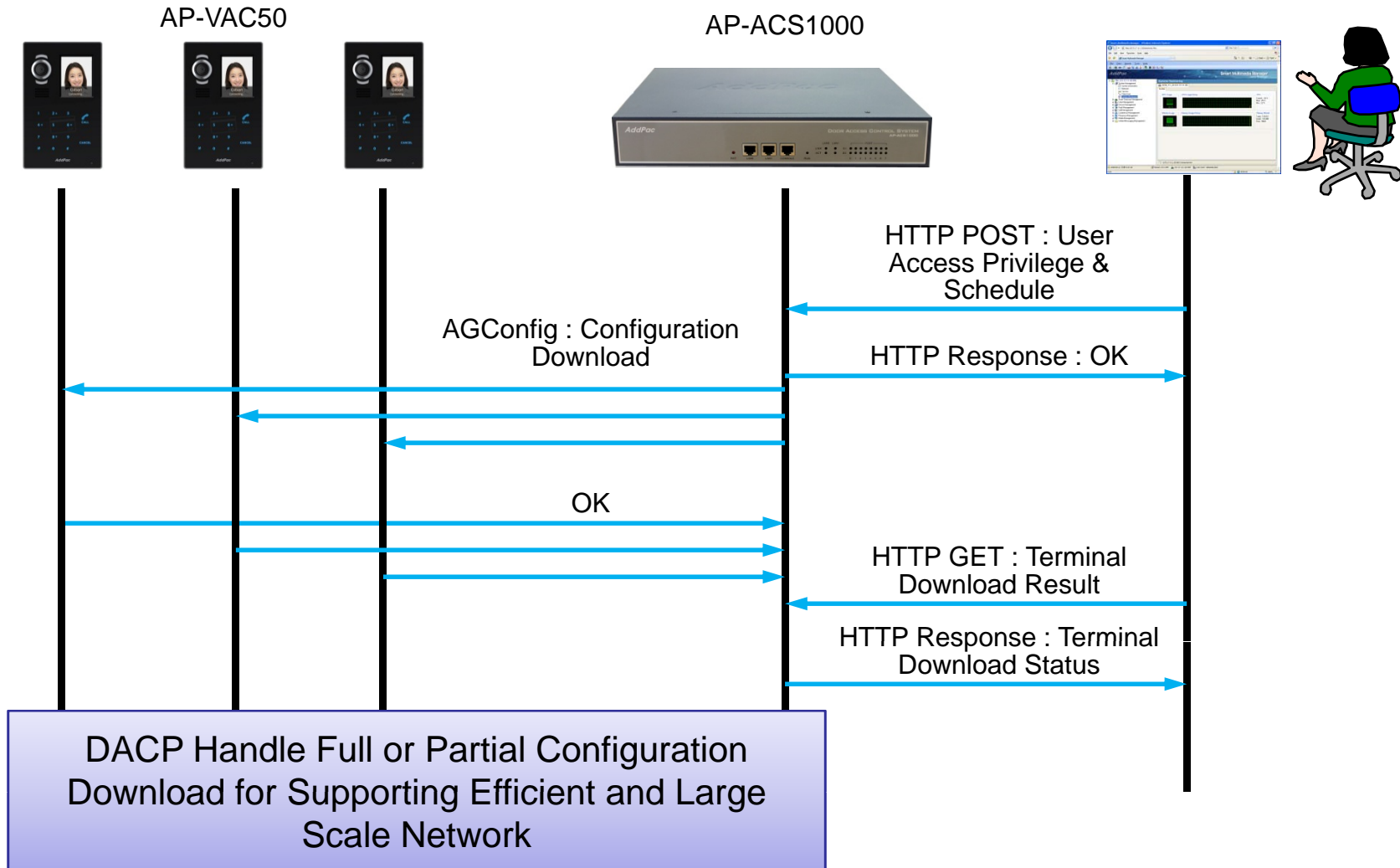

DACS System Message Flow

RF Card Read/Write and Registration

AP-VAC50



AP-ACS1000

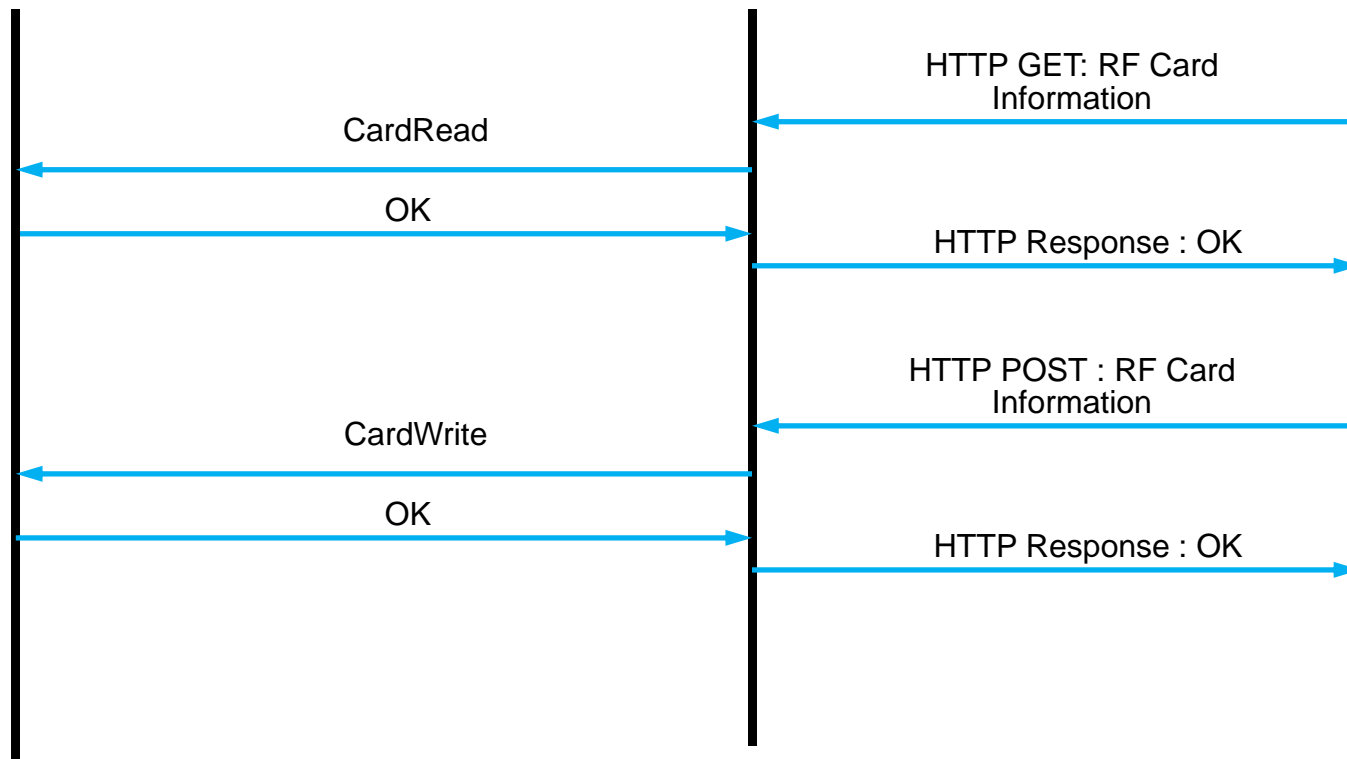
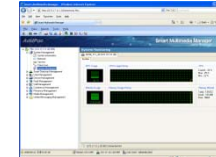

DACS System Message Flow

Door Open by RF Card or Password

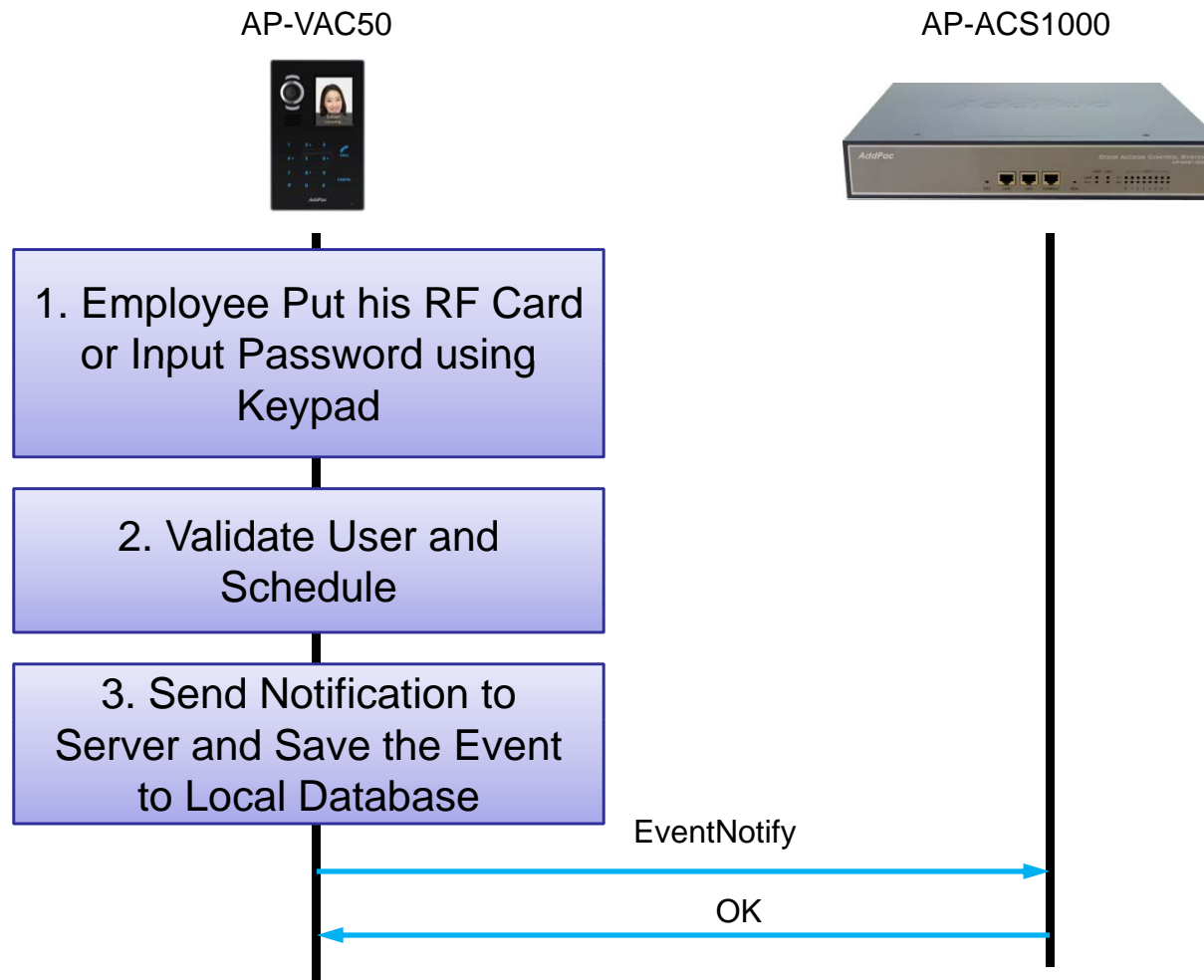

DACS System Message Flow

Door Open by Other Terminal

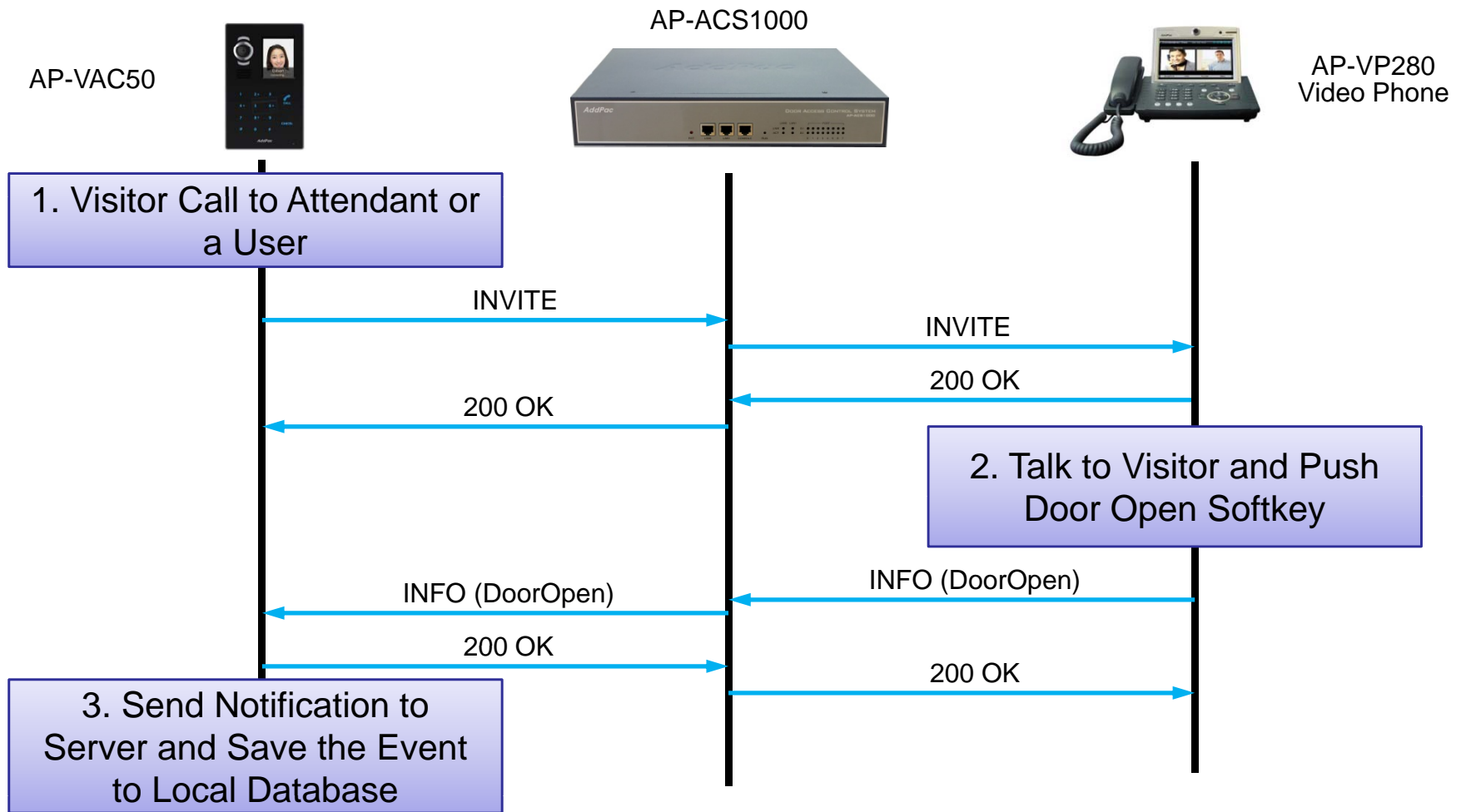



Door Access Control Manager for AP-ACS1000

DACM (Door Access Control Manager)

Main Web Page

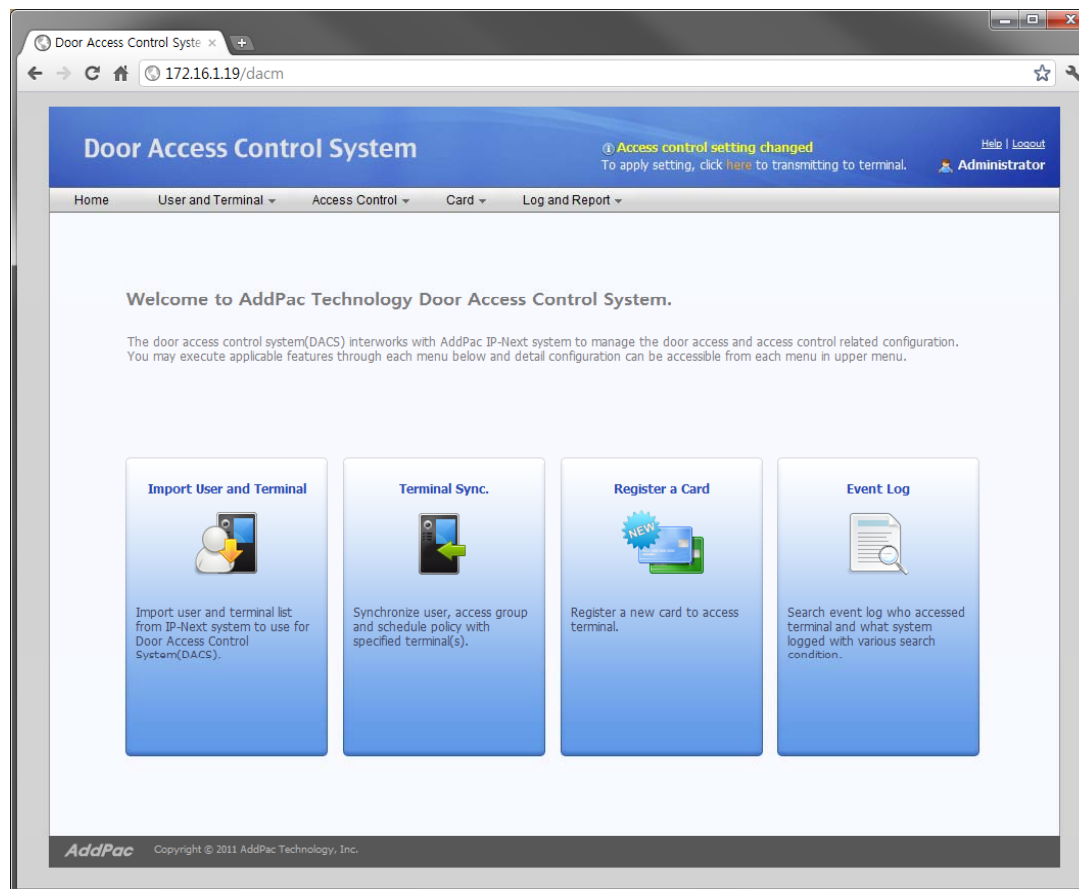

DACM (Door Access Control Manager)

Import User and Terminal

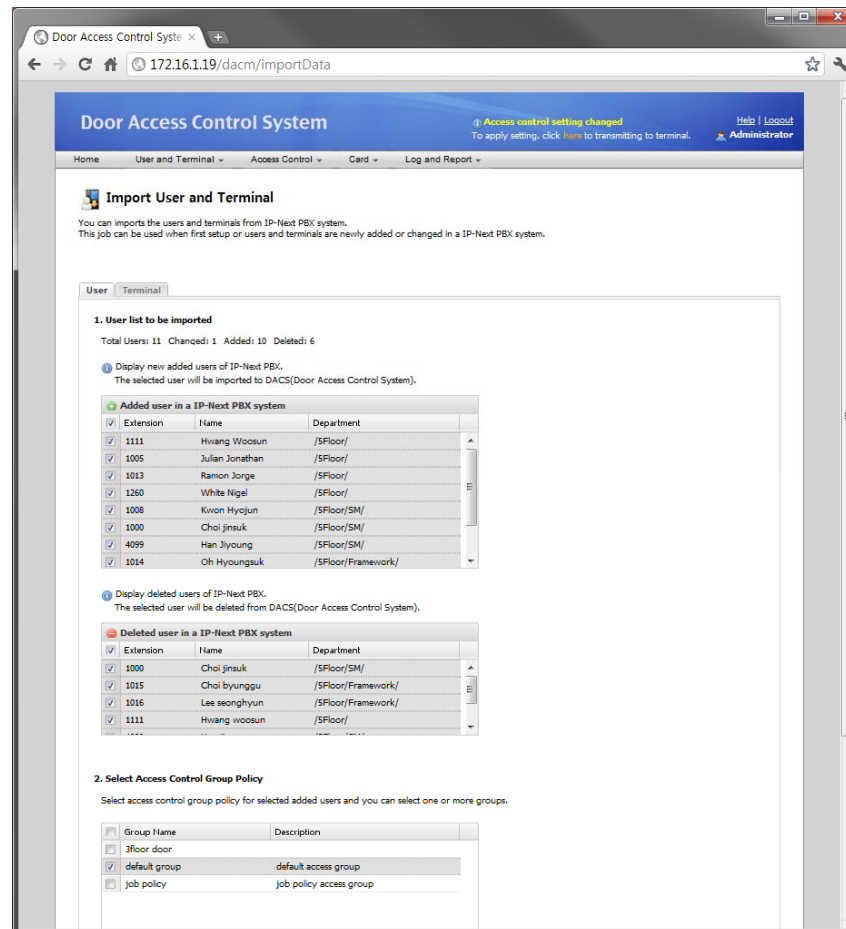

DACM (Door Access Control Manager)

User List

The screenshot shows a web browser window displaying the 'Door Access Control System' user list. The page title is 'Door Access Control System' and the URL is '172.16.1.19/dacm/userList'. A notification at the top right states 'Access control setting changed' with a link to 'here' and a 'Logout' button. The user is logged in as 'Administrator'. The main content area is titled 'User List' and includes a search bar with a dropdown set to 'All Users' and an 'Import User' button. Below the search bar is a table with the following data:

	Extension	Name	Department	Access Policy	Date Created	Modify	Delete
1	1000	Choi jinsuk	/SFloor/SM/	Access Allow	2011-07-22 15:50:01		
2	1008	Kwon hyojun	/SFloor/SM/	Access Allow	2011-07-22 15:50:00		
3	1014	Oh hyongsuk	/SFloor/Framework/	Access Allow	2011-07-22 15:50:01		
4	1015	Choi byunggu	/SFloor/Framework/	Access Allow	2011-07-22 15:50:01		
5	1016	Lee seonghyun	/SFloor/Framework/	Access Allow	2011-07-22 15:50:01		

At the bottom of the page, there is a pagination control showing 'Page 1 of 1' and a 'Total: 5' indicator. The footer contains the 'AddPac' logo and 'Copyright © 2011 AddPac Technology, Inc.'.

DACM (Door Access Control Manager)

Terminal List

Door Access Control System

Access control setting changed
To apply setting, click [here](#) to transmitting to terminal.

Help | Logout
Administrator

Home User and Terminal Access Control Card Log and Report

Terminal List

Display the registered door phone lists imported from IP-Next PBX system.

Import Terminal

	Terminal Name	Description	Status	Extension	IP Address	Model Name	Version	Date Created	Detail View
1	2floor door terminal	2Floor door ter...	Connected	1006	172.16.10.4	AP-VAC50		2011-07-29 17:08:50	
2	3floor door terminal	3Floor door ter...	Connected	1002	172.16.10.1	AP-VAC20	8.50.001	2011-07-22 15:50:01	
3	5floor door terminal	5Floor door ter...	Connected	1005	172.16.10.2	AP-VAC50		2011-07-29 17:08:50	
4	The main entrance d...	The main entran...	Connected	Required setting	172.16.10.3	AP-VAC100		2011-07-29 17:08:50	

Page 1 of 1 Total: 4

AddPac Copyright © 2011 AddPac Technology, Inc.

DACM (Door Access Control Manager)

Access Control Group Management

The screenshot displays the 'Door Access Control System' web interface. The browser address bar shows '172.16.1.19/dacm/accessGroupList'. The page title is 'Door Access Control System'. A notification banner at the top right states 'Access control setting changed' and provides a link to apply settings. The navigation menu includes 'Home', 'User and Terminal', 'Access Control', 'Card', and 'Log and Report'. The main content area is titled 'Access Control Group' and includes a brief description: 'You can define a new Access Control Group with one or more terminals, users and schedule policy. Also, you can adjust priority of access control group using up/down arrow (or mouse drag/drop)'. A table lists existing groups with columns for Group Name, Description, Schedule Policy, Date Created, Modify, and Delete. The table contains three entries: '3floor door', 'job policy', and 'default group'. A footer at the bottom left shows the 'AddPac' logo and copyright information: 'Copyright © 2011 AddPac Technology, Inc.'

Group Name	Description	Schedule Policy	Date Created	Modify	Delete
3floor door		All Allow	2011-06-28 11:37:13		
job policy	job policy access group	working day	2011-07-04 17:06:47		
default group	default access group	All Allow	2011-06-28 11:37:13		

DACM (Door Access Control Manager)

Configuration Download to Terminal

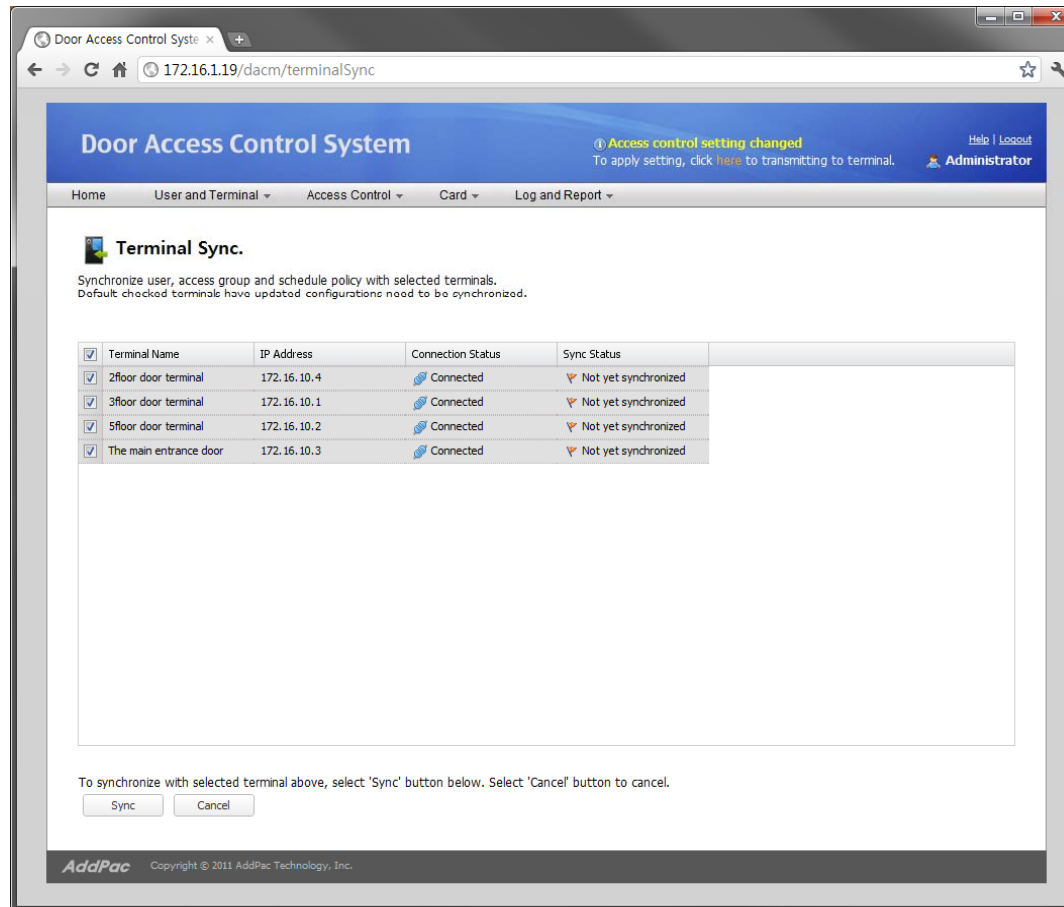

Door Access Control System

Access control setting changed
To apply setting, click [here](#) to transmitting to terminal.

Help | Logout
Administrator

Home User and Terminal Access Control Card Log and Report

Terminal Sync.

Synchronize user, access group and schedule policy with selected terminals.
Default checked terminals have updated configurations need to be synchronized.

<input checked="" type="checkbox"/>	Terminal Name	IP Address	Connection Status	Sync Status
<input checked="" type="checkbox"/>	2floor door terminal	172.16.10.4	Connected	Not yet synchronized
<input checked="" type="checkbox"/>	3floor door terminal	172.16.10.1	Connected	Not yet synchronized
<input checked="" type="checkbox"/>	5floor door terminal	172.16.10.2	Connected	Not yet synchronized
<input checked="" type="checkbox"/>	The main entrance door	172.16.10.3	Connected	Not yet synchronized

To synchronize with selected terminal above, select 'Sync' button below. Select 'Cancel' button to cancel.

AddPac Copyright © 2011 AddPac Technology, Inc.

DACM (Door Access Control Manager)

RF Card Management

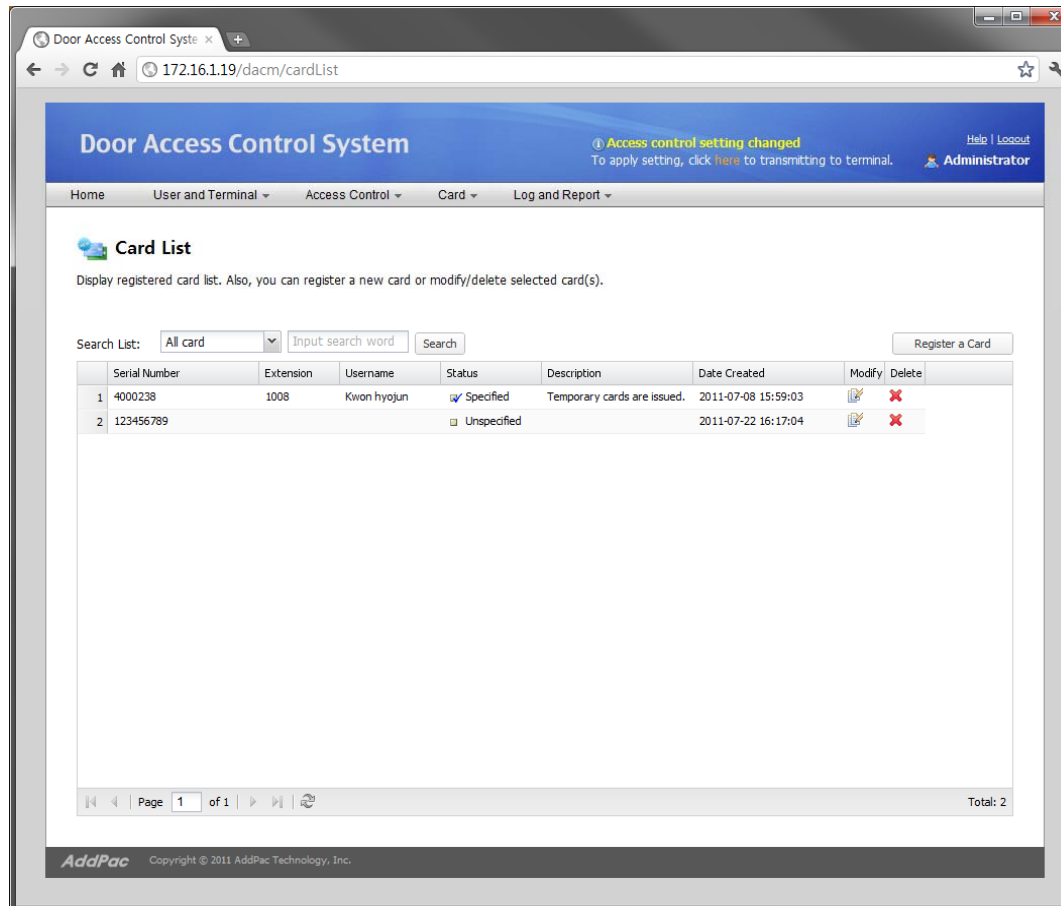

The screenshot displays the 'Door Access Control System' web interface. The browser address bar shows '172.16.1.19/dacm/cardList'. The page title is 'Door Access Control System'. A notification banner indicates 'Access control setting changed' with instructions to click a link to transmit settings to the terminal. The user is logged in as 'Administrator'. The main content area is titled 'Card List' and includes a search filter set to 'All card' and a search input field. A table lists two registered cards:

Serial Number	Extension	Username	Status	Description	Date Created	Modify	Delete
1 4000238	1008	Kwon hyojun	<input checked="" type="checkbox"/> Specified	Temporary cards are issued.	2011-07-08 15:59:03		
2 123456789			<input type="checkbox"/> Unspecified		2011-07-22 16:17:04		

At the bottom of the page, there is a pagination control showing 'Page 1 of 1' and a 'Total: 2' indicator. The footer contains the 'AddPac' logo and copyright information: 'Copyright © 2011 AddPac Technology, Inc.'

DACM (Door Access Control Manager)

Access Log Management

The screenshot shows a web browser window displaying the 'Door Access Control System' interface. The page title is 'Door Access Control System' and the URL is '172.16.1.19/dacm/eventLog'. The user is logged in as 'Administrator'. A notification banner at the top right states 'Access control setting changed' with a link to 'Apply setting, click here to transmitting to terminal.' The main content area is titled 'Event Log' and includes a search filter section with fields for 'Duration' (11-07-10 to 11-08-09), 'User Extension Number', and 'Event Level' (set to 'Error'). Below the search filters is a table of event logs with columns for 'Time', 'Level', 'User Extension', and 'Event'. The table contains 7 entries. At the bottom of the page, there is a pagination control showing 'Page 1 of 1' and a 'Total: 7' indicator. The footer of the page includes the 'AddPac' logo and 'Copyright © 2011 AddPac Technology, Inc.'

	Time	Level	User Extension	Event
1	2011-07-15 10:27:27	Warning	1000	authentication failure
2	2011-07-15 11:25:27	Notice	1000	registration success
3	2011-07-15 12:21:27	Notice	1200	registration success
4	2011-07-16 09:27:27	Information	1201	door opened
5	2011-07-16 11:27:27	Information	1007	registration success
6	2011-07-16 17:12:00	Notice		security profile downloading completed
7	2011-07-17 18:00:00	Notice		system started



AP-ACS1000 Open API

Open API

Open API for 3'rd Party Management System

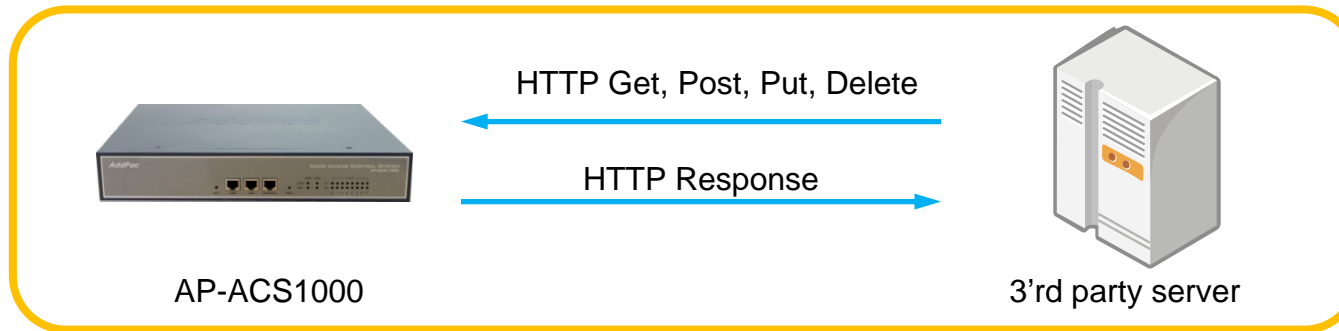

- HTTP based RESTful Open API for Door Access Management
- XML based Flexible and Expandable Message Contents
- Provides More than 40 APIs as Bellow
 - user_list(GET), user(GET, POST, PUT, DELETE), ...
 - terminal_list(GET), terminal(GET, POST, PUT, DELETE), ...
 - access_group(GET, POST, PUT, DELETE), priority (PUT), ...
 - card_list(GET), card(POST, PUT, DELETE), ...
 - schedule_template(GET, POST, PUT, DELETE), rule(GET, POST, PUT, DELETE) ,...



IP Video Phone Solution for SIP Video Call Center

IP Video Phone Comparison Table

	<p>AP-VP280DM</p> 
LCD Size	7 Inch Touch Screen
Camera	CMOS
Video Codec	H.263 MPEG4 H.264
Signaling	H.323/SIP
Camera Sensor	SD
Video Resolution	SD
External Monitor	HDMI
LAN Port	1
PoE	Support

AP-NR1500 IP Video Recording Server



Product Overview

AP-NR1500 IP Video Recoding Server

- IP based Network Video Recording Server
- Linux Operating System
- Powerful Management and User Friendly Features
- High-performance Video Recording Service
- External AddPac Video Terminal (Ex: Video Phone) Interworking Support
- Firmware Upgradeable Architecture
- One(1) 10/100/1000Mbps Gigabit Ethernet Interface
- Up to Two(2) 3.5Inch SATA Hard Disk Interface Support
- Two(2) USB Interface Support
- One(1) RS232C Console Interface

Hardware Specification

AP-N1500 IP Video Recording Server

- High Performance Computing Power
- Network Interface
 - One(1) 10/100/1000Mbps Gigabit Ethernet Port
- Two(2) USB 2.0 Interfaces for Mouse, Secondary Storage, etc
- One(1) RS232C Console Interface (RJ45)
- Up Two(2) SATA type Hard Disk (4~8 Tera HDD Capacity)
- Power On/Off Soft Switch with LED Indication Lamp (Front Side)

Hardware Specification

AP-NR1500 IP Video Recording Server

AP-NR1500 Front Side



Power On/Off Switch with LED Indication LAMP

Hardware Specification

AP-NR1500 IP Video Recording Server

AP-NR1500 Back Side

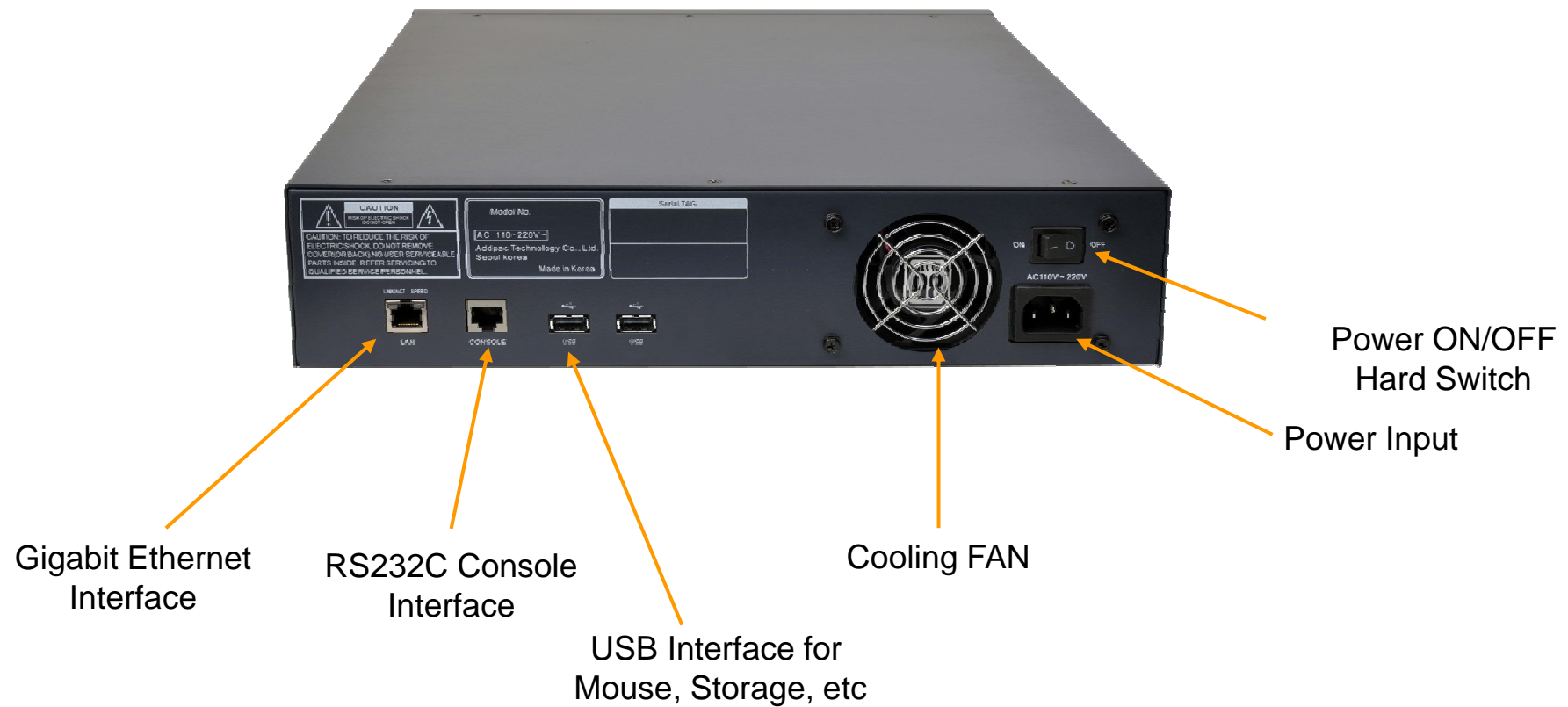

Software Service

AP-NR1500 IP Video Recording Server

- **Built-in AddPac Internetworking Software**
 - Scalability, Functionality, and Stability Features
 - Advanced Network Video Recording & Live Streaming Features
- **Firmware Upgradeable Architecture**
- **Industry Standard Network Protocol Features**
- **Highly User Friendly Management Features**
 - PC based Window Program
 - Smart Recording Manager

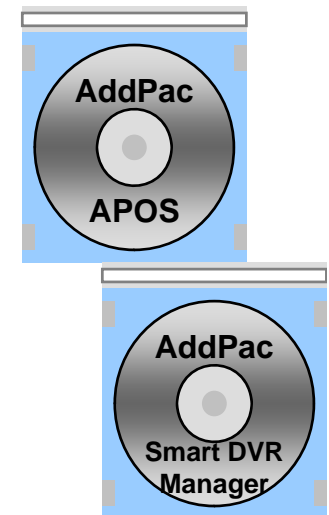

Smart Recording Manager Program

AP-NR1500 IP Video Recording Server

- User Management (registration/modify/delete/search)
- Recording Server Management
- Recording File Management
- Recording File Play with VLC application
- Export Recording History to File(EXEL)
- Live Call Monitoring (Play)
- Event Management
- Recording Board Management
- Smart Recording File Manager

User Management

Smart Recording Manager

File Record Management Advanced Configuration Help

Smart Recording Manager

Users [NR5000:172.17.50.200]

User Name	ID	Level	Description
root	root	Administrator	System Administrator
Administrator	administrator	Administrator	Addpac Administrator

New Manager Registration

Manager Information Modification

Manager Delete

Status

Status	Server	Session
+	NR5000(172.17.50.200)	0

2016-07-06 오후 2:44:40 Ver. 2.1.6031 User Id = root Level = Administrator

Recording Server Management

*Recording Server Management

*Server Status Information

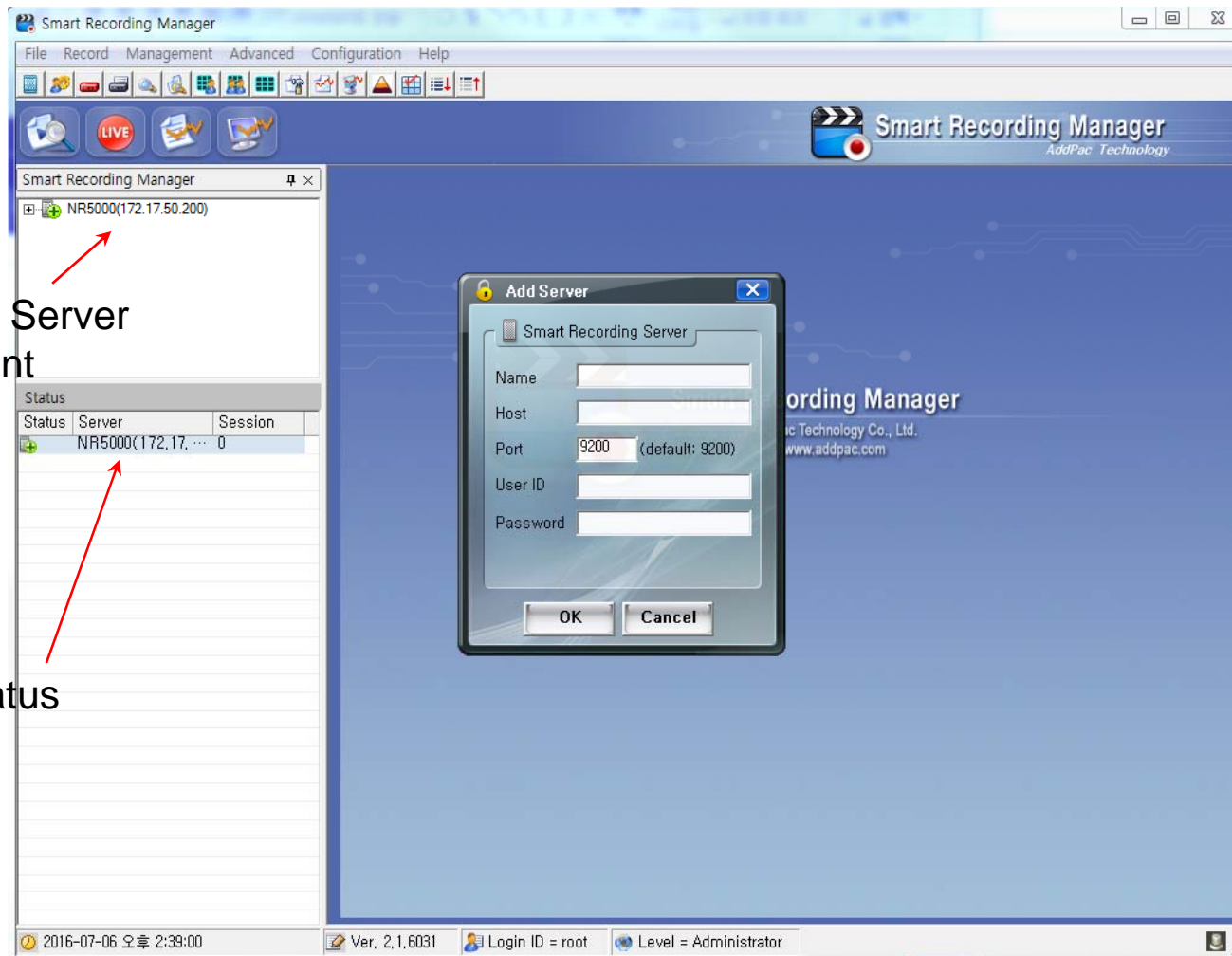

Recording Server Status Monitoring

The screenshot displays the Smart Recording Manager interface. The main window shows the 'Smart Recording Server [NR5000:172.17.50.200]' status as 'running'. A configuration dialog box is open, showing 'Client Session List' settings: Max Session: 10, Keep Alive Interval: 5 sec. Below this, a table lists active sessions. A red arrow points to the first row of the table, which is labeled 'Client List'.

No.	User	IP Address	Port	Access Time	Duration
1	root	172.16.1.19	49988	2016-07-06 14:42:00	00:07:34

Recording File Management

The screenshot displays the Smart Recording Manager interface. The main window shows a search results table with columns: No., Call ID, Source IP, Rec StartTime, Rec EndTime, Rec Duration, Call Duration, Calling Num, Calling User, and Called Num. A red arrow points from the 'Source IP' column to the 'Search Filter' dialog box.

No.	Call ID	Source IP	Rec StartTime	Rec EndTime	Rec Duration	Call Duration	Calling Num	Calling User	Called Num
2	2	172.16.9.29	2016-07-05 10:30:16	2016-07-05 10:30:16	00:00:00	00:00:01	1000		3000
2	3	172.16.9.29	2016-07-05 12:47:45	2016-07-05 12:47:45	00:00:00	00:01:00	1000		3000
3	6	172.16.9.29	2016-07-05 12:50:28	2016-07-05 12:50:28	00:00:00	00:00:00	1000		3001
4	7	172.16.9.29	2016-07-05 12:50:40	2016-07-05 12:50:40	00:00:00	00:00:16	1000		3001
5	9	172.16.9.29	2016-07-05 12:51:05	2016-07-05 12:51:05	00:00:00	00:02:03	1000		3001
6	10	172.16.9.29	2016-07-05 12:51:09	2016-07-05 12:51:09	00:00:00	00:01:05	1000		3000
7	12	172.16.9.29	2016-07-05 12:53:09	2016-07-05 12:53:09	00:00:00	00:01:03	1000		3001
8	14	172.16.9.29	2016-07-05 14:10:01	2016-07-05 14:10:01	00:00:00	00:00:43	1000		3001
9	15	172.16.9.29	2016-07-05 14:11:27	2016-07-05 14:11:27	00:00:00	00:01:02	1000		3001
10	16	172.16.9.29	2016-07-05 14:12:42	2016-07-05 14:12:42	00:00:00	00:00:11	1000		3001
11	17	172.16.9.29	2016-07-05 14:13:03	2016-07-05 14:13:03	00:00:00	00:00:13	1000		3001
12	18	172.16.9.29	2016-07-05 14:13:24	2016-07-05 14:13:24	00:00:00	00:00:10	1000		3001
13	19	172.16.9.29	2016-07-05 16:53:52	2016-07-05 16:53:54	00:00:02	00:37:33	1000		3001
15	17:36:21				00:00:00	00:00:05	1000		3001
15	17:39:37				00:00:00	00:00:22	1000		3001
15	17:42:57				00:00:00	00:00:37	1000		3001
15	17:48:28				00:00:00	00:00:16	1000		3001
15	18:00:25				00:00:35	00:00:39	1000		3001
16	09:23:08				00:00:13	00:00:19	1000		3001
16	09:31:32				00:02:13	00:02:18	1000		3001
16	09:47:12				00:00:00	00:00:00	1000		3001
16	09:48:11				00:00:46	00:00:49	1000		3000
16	09:49:08				00:00:43	00:00:46	1000		3000
16	09:51:31				00:00:14	00:00:17	1000		3000
16	10:42:17				00:00:14	00:00:15	1000		3000
16	13:46:19				00:00:04	00:00:06	1000		3000

The Search Filter dialog box includes the following fields:

- Record Time: Start Time (2016-07-05 00:00:00), End Time (2016-07-06 23:59:59)
- Filter section with columns: Filter Name, Rule, Search, and a dropdown menu.
- Buttons: OK, Cancel, Init Filter
- Checkbox: Recording Service Unavailable Files (not G711U codec)
- Note: * It may take a long time.

System status bar at the bottom shows: 2016-07-06 2:48:56, Ver. 2.1.6031, User Id = root, Level = Administrator.

Recording File Play with VLC application

The screenshot displays the Smart Recording Manager application interface. The main window shows a list of recordings with the following data:

No.	Call ID	Source IP	Rec StartTime	Rec EndTime	Rec Duration	Call Duration	Calling Num	Ca
1	25	172.16.9.29	2016-07-06 09:22:55	2016-07-06 09:23:08	00:00:13	00:00:19	1000	
2	26	172.16.9.29	2016-07-06 09:29:19	2016-07-06 09:31:32	00:02:13	00:02:18	1000	
3	27	172.16.9.29	2016-07-06 09:47:12	2016-07-06 09:47:12	00:00:00	00:00:00	1000	
4	28	172.16.9.29	2016-07-06 09:47:25	2016-07-06 09:48:11	00:00:46	00:00:49	1000	
5	29	172.16.9.29	2016-07-06 09:48:25	2016-07-06 09:49:08	00:00:43	00:00:46	1000	
6	30	172.16.9.29	2016-07-06 09:51:17	2016-07-06 09:51:31	00:00:14	00:00:17	1000	
7	31	172.16.9.29	2016-07-06 10:42:03	2016-07-06 10:42:17	00:00:14	00:00:15	1000	
8	1	172.16.9.29	2016-07-06 13:46:15	2016-07-06 13:46:19	00:00:04	00:00:06	1000	
9	3	172.16.9.29	2016-07-06 15:13:06	2016-07-06 16:42:14	01:29:08	01:29:12	1000	
10	4	172.16.9.29	2016-07-06 16:42:24	2016-07-06 16:42:37	00:00:13	00:00:11	1000	
11	5	172.16.9.29	2016-07-06 16:42:45	2016-07-06 16:43:09	00:00:24	00:00:25	1000	
12	6	172.16.9.29	2016-07-06 16:43:26	2016-07-06 16:44:02	00:00:36	00:00:38	1000	

Two video playback windows are shown below the main interface:

- The left window, titled "2016-07-06 16:43:26", shows a video frame of a woman in an office setting.
- The right window, titled "AddPac Technology - 0000620160706074326-000041--M.avi - ...", shows a video frame of a man in an office setting. The VLC player interface is visible, including playback controls and a progress bar.

At the bottom left, the "AddPac" logo is visible. At the bottom center, the website "www.addpac.com" is partially visible. At the bottom right, the page number "43" is displayed.

Live Call Monitoring

The screenshot displays the Smart Recording Manager software interface. The main window shows a table of recorded calls with the following data:

No.	Call ID	Source IP	Rec StartTime	Initiated Time	Call Duration	Calling Num	Calling User	Called Num	Called User	AI
1	25	172.16.9.29	2016-07-06 09:22:55	2016-07-06 09:23:08	00:00:13	1000		3001		
2	26	172.16.9.29	2016-07-06 09:29:19	2016-07-06 09:31:32	00:02:13	1000		3001		
3	27	172.16.9.29	2016-07-06 09:47:12	2016-07-06 09:47:12	00:00:00	1000		3001		
4	28	172.16.9.29	2016-07-06 09:47:25	2016-07-06 09:48:11	00:00:46	1000		3000		
5	29	172.16.9.29	2016-07-06 09:48:25	2016-07-06 09:49:08	00:00:43	1000		3000		
6	30	172.16.9.29	2016-07-06 09:51:17	2016-07-06 09:51:31	00:00:14	1000		3000		
7	31	172.16.9.29	2016-07-06 10:42:03	2016-07-06 10:42:17	00:00:14	1000		3000		
8	1	172.16.9.29	2016-07-06 13:46:15	2016-07-06 13:46:19	00:00:04	1000		3000		

Below the table, two VLC media player windows are open, showing live video feeds from the recorded calls. The left window shows a man in a white shirt and tie, and the right window shows a woman in a white top and glasses. A red arrow points from the play button in the Smart Recording Manager interface to the first row of the call log table.

Export Recording History

Smart Recording Manager - [Record Search [NR5000:172.17.50.200]]

File Record Management Advanced Configuration Help

Smart Recording Manager

NR5000(172.17.50.200)

- User Management
- Device Management
- Recording Management
- Record Search
- Record Session
- Recording Board
- Event & Monitoring
- System Management

Status

Status	Server	Session
+	NR5000(172.17. ...	0

No.	Call ID	Source IP	Rec StartTime	Rec EndTime
1	2	172.16.9.29	2016-07-05 10:30:16	2016-07-05 10:30:16
2	3	172.16.9.29	2016-07-05 12:47:45	2016-07-05 12:47:45
3	6	172.16.9.29	2016-07-05 12:50:28	2016-07-05 12:50:28
4	7	172.16.9.29	2016-07-05 12:50:40	2016-07-05 12:50:40
5	9	172.16.9.29	2016-07-05 12:51:05	2016-07-05 12:51:05
6	10	172.16.9.29	2016-07-05 12:51:09	2016-07-05 12:51:09
7	12	172.16.9.29	2016-07-05 12:53:09	2016-07-05 12:53:09
8	14	172.16.9.29	2016-07-05 14:10:01	2016-07-05 14:10:01
9	15	172.16.9.29	2016-07-05 14:11:27	2016-07-05 14:11:27
10	16	172.16.9.29	2016-07-05 14:12:42	2016-07-05 14:12:42
11	17	172.16.9.29	2016-07-05 14:13:03	2016-07-05 14:13:03
12	18	172.16.9.29	2016-07-05 14:13:24	2016-07-05 14:13:24
13	19	172.16.9.29	2016-07-05 16:53:52	2016-07-05 16:53:52
14	20	172.16.9.29	2016-07-05 16:53:52	2016-07-05 16:53:52
15	21	172.16.9.29	2016-07-05 16:53:52	2016-07-05 16:53:52
16	22	172.16.9.29	2016-07-05 16:53:52	2016-07-05 16:53:52
17	23	172.16.9.29	2016-07-05 17:48:28	2016-07-05 17:48:28
18	24	172.16.9.29	2016-07-05 17:59:50	2016-07-05 18:00:25
19	25	172.16.9.29	2016-07-06 09:22:55	2016-07-06 09:23:08
20	26	172.16.9.29	2016-07-06 09:29:19	2016-07-06 09:31:32
21	27	172.16.9.29	2016-07-06 09:47:12	2016-07-06 09:47:12
22	28	172.16.9.29	2016-07-06 09:47:25	2016-07-06 09:48:11
23	29	172.16.9.29	2016-07-06 09:48:25	2016-07-06 09:49:08
24	30	172.16.9.29	2016-07-06 09:51:17	2016-07-06 09:51:31
25	31	172.16.9.29	2016-07-06 10:42:03	2016-07-06 10:42:17
26	1	172.16.9.29	2016-07-06 13:46:15	2016-07-06 13:46:19

Records Exporting !!! ... Cancel

73%

Export Date : 2016-07-06 오후 2:53:25
Export Count : 26
Record Date : 2016-07-05 오전 12:00:00 - 2016-07-06 오후 11:59:59

Call ID	Source IP	Record Start Time	Record End Time	Record Di	Call Durat	Calling N	Calling U	Calling S	Called Nu	Called Us	Called Slot/Port/Chann
2	172.16.9.29	2016-07-05 10:30	2016-07-05 10:30	00:00	00:00:10	0000	0000	0000	0000	0000	0/0/0
3	172.16.9.29	2016-07-05 12:47	2016-07-05 12:47	00:00	00:00:10	0000	0000	0000	0000	0000	0/0/0
6	172.16.9.29	2016-07-05 12:50	2016-07-05 12:50	00:00	00:00:10	0000	0000	0000	0000	0000	0/0/0
7	172.16.9.29	2016-07-05 12:50	2016-07-05 12:50	00:00	00:00:10	0000	0000	0000	0000	0000	0/0/0
9	172.16.9.29	2016-07-05 12:51	2016-07-05 12:51	00:00	00:00:10	0000	0000	0000	0000	0000	0/0/0
10	172.16.9.29	2016-07-05 12:51	2016-07-05 12:51	00:00	00:00:10	0000	0000	0000	0000	0000	0/0/0
12	172.16.9.29	2016-07-05 12:53	2016-07-05 12:53	00:00	00:00:10	0000	0000	0000	0000	0000	0/0/0
14	172.16.9.29	2016-07-05 14:10	2016-07-05 14:10	00:00	00:00:10	0000	0000	0000	0000	0000	0/0/0
15	172.16.9.29	2016-07-05 14:11	2016-07-05 14:11	00:00	00:00:10	0000	0000	0000	0000	0000	0/0/0
16	172.16.9.29	2016-07-05 14:12	2016-07-05 14:12	00:00	00:00:10	0000	0000	0000	0000	0000	0/0/0
17	172.16.9.29	2016-07-05 14:13	2016-07-05 14:13	00:00	00:00:10	0000	0000	0000	0000	0000	0/0/0
18	172.16.9.29	2016-07-05 14:13	2016-07-05 14:13	00:00	00:00:10	0000	0000	0000	0000	0000	0/0/0
19	172.16.9.29	2016-07-05 16:53	2016-07-05 16:53	00:00	00:00:10	0000	0000	0000	0000	0000	0/0/0
20	172.16.9.29	2016-07-05 17:36	2016-07-05 17:36	00:00	00:00:10	0000	0000	0000	0000	0000	0/0/0
21	172.16.9.29	2016-07-05 17:39	2016-07-05 17:39	00:00	00:00:22	0000	0000	0000	0000	0000	0/0/0
22	172.16.9.29	2016-07-05 17:42	2016-07-05 17:42	00:00	00:00:37	0000	0000	0000	0000	0000	0/0/0
23	172.16.9.29	2016-07-05 17:48	2016-07-05 17:48	00:00	00:00:16	0000	0000	0000	0000	0000	0/0/0
24	172.16.9.29	2016-07-05 17:59	2016-07-05 18:00	00:00	00:00:35	0000	0000	0000	0000	0000	0/0/0
25	172.16.9.29	2016-07-06 09:22	2016-07-06 09:23	00:00	00:00:19	0000	0000	0000	0000	0000	0/0/0
26	172.16.9.29	2016-07-06 09:29	2016-07-06 09:31	00:00	00:00:18	0000	0000	0000	0000	0000	0/0/0
27	172.16.9.29	2016-07-06 09:47	2016-07-06 09:47	00:00	00:00:10	0000	0000	0000	0000	0000	0/0/0
28	172.16.9.29	2016-07-06 09:47	2016-07-06 09:48	00:00	00:00:49	0000	0000	0000	0000	0000	0/0/0
29	172.16.9.29	2016-07-06 09:48	2016-07-06 09:49	00:00	00:00:46	0000	0000	0000	0000	0000	0/0/0

2016-07-06 오후 2:53:25 Ver. 2.1,6031 User Id = root Level = Administrator

Event Configuration

Smart Recording Manager

File Record Management Advanced Configuration Help

Smart Recording Manager AddPac Technology

NR5000(172.17.50.200)

- User Management
- Device Management
- Recording Management
- Recording Board
- Event & Monitoring
 - Event Configuration
 - Event Monitoring
 - System Monitoring

Status

Status	Server	Session
+	NR5000(172.17. ...	0

Event Configuration [NR5000:172.17.50.200]

Event Source

Listen Port : 514

1. Emergency
The presence of a condition that has either caused the system to become unstable or has crashed the system.

2. Error
Error events are warnings of conditions that will affect the performance of the MX.

Event Filter

* Set event filter for source.

Select / Deselect All

Category	Severity	Description
<input type="checkbox"/> recording	Warning	recording
<input type="checkbox"/> play	Warning	play
<input type="checkbox"/> system	Warning	system

OK Cancel

2016-07-06 오후 3:06:48 Ver. 2.1.6031 User Id = root Level = Administrator

event level filter settings

Event Management (Monitoring)

The screenshot displays the Smart Recording Manager interface. The main window shows a table of recording sessions with the following data:

No.	Call ID	Source IP	Rec StartTime	Initiated Time	Established Time	Call Duration	Calling
1	3	172.16.9.29	2016-07-06 15:13:06	2016-07-07 00:07:38	2016-07-07 00:07:38	00:02:59	1000

Annotations with red arrows point to the following features:

- Event monitoring**: Points to the 'Event Monitoring' option in the left-hand navigation tree.
- Event filter**: Points to the 'Event filter' button in the top right of the main window.
- Pause event**: Points to the 'Pause' button in the bottom right of the main window.

At the bottom of the interface, there is an 'Event Monitoring' log window with the following data:

DateTime	Host	Severity	Module	Description
Jul 06 06:13:06	172.17.50.200	Informational	recording	Start Recording, bind id:-10000
Jul 06 06:15:31	172.17.50.200	Debug	system	get current recording session :
Jul 06 06:15:33	172.17.50.200	Debug	system	get current recording session :
Jul 06 06:15:43	172.17.50.200	Debug	system	get current recording session :
Jul 06 06:15:55	172.17.50.200	Debug	system	get current recording session :
Jul 06 06:16:05	172.17.50.200	Debug	system	get current recording session :

The bottom status bar shows: 2016-07-06 오후 3:12:38, Ver. 2.1,6031, User Id = root, Level = Administrator.

Event Management (System Monitoring)

The screenshot displays the Smart Recording Manager interface with the following components:

- Left Panel:** A tree view showing the system hierarchy: NR5000(172.17.50.200) > User Management > Device Management > Recording Management > Recording Board > Event & Monitoring > Event Configuration > Event Monitoring > System Monitoring > System Management.
- Status Table:**

Status	Server	Session
+	NR5000(172,17,...	1
- System Monitoring Dashboards:**
 - CPU Usage:** A gauge showing 0% usage.
 - CPU Usage History:** A line graph showing 0% usage over time.
 - Memory Usage:** A gauge showing 1501 MB usage.
 - Memory Usage History:** A line graph showing memory usage over time.
 - Transcoding Usage:** A gauge showing Max: 0 and 0 usage.
 - Transcoding Channel History:** A line graph showing transcoding channel usage over time.
 - Database(/) Usage:** A gauge showing 10 usage.
 - Storage Usage:** A table showing usage for Database(/), Hdd0(/boot), and Hdd1(/home).
- System Information:**
 - CPU:** Total(%) 100, Used(%) 0.
 - Memory:** Total 1919328 KB, Available 381836 KB, Used 1537492 KB, Used(%) 80.11.
 - Transcoding Channel:** Max 0, Used 0.
 - HDD:** Total 1918.78 GB, Available 1908.75 GB, Used 10.03 GB, Used(%) 0.52.

cpu usage (%)

memory usage

transcoding monitoring

Storage usage

Recording Board

(User)

The screenshot displays the 'Smart Recording Manager' application window. The title bar reads 'Smart Recording Manager - [Users [NR5000:172.17.50.200]]'. The menu bar includes 'File', 'Record', 'Management', 'Advanced', 'Configuration', and 'Help'. A toolbar with various icons is located below the menu. The main interface features a left-hand navigation tree with categories like 'User Management', 'Device Management', 'Recording Management', 'Recording Board', 'Users', 'Groups', 'Map List', 'Event & Monitoring', and 'System Management'. The 'Recording Board' section is active, displaying a table of users. The table has columns for 'No.', 'User ID', 'Name', 'Phone Number', 'Description', and 'Group'. Below the table is a 'Status' section with a table showing server and session information. The bottom status bar indicates the date and time as '2016-07-06 오후 3:25:38', the version as 'Ver. 2.1.6031', and the user level as 'Level = Administrator'.

No.	User ID	Name	Phone Number	Description	Group
1	bgchoi	Choi Byung Koo	1024		Signaling
2	jhkwon	Kwon	3000		NMS
3	jschoi	Choi Jin suk	1007		NMS
4	ohs	Oh hyung suk	1000		Signaling
5	sklee	Lee sang kyun	1009		Signaling

Status	Server	Session
+	NR5000(172.17, ...	1

Recording Board (Group)

The screenshot displays the Smart Recording Manager application window. The main interface shows a tree view on the left with 'Recording Board' selected. The central area contains a table with the following data:

No.	Name	Description
1	NMS	
2	Signaling	

A 'Group Properties' dialog box is open, showing the 'Signaling' group selected. The dialog includes fields for 'Group Name' (Signaling) and 'Description'. Below these are two tables for user management:

Users		
User ID	Name	Phone Number

Users in Group		
User ID	Name	Phone Number
bgchoi	Choi Byu...	1024
ohs	Oh hyung...	1000
sklee	Lee sang...	1009

The dialog box has 'OK' and 'Cancel' buttons at the bottom. The status bar at the bottom of the application shows the date and time as 2016-07-06 오후 3:26:00, version 2.1.6031, and user information: User Id = root, Level = Administrator.

Recording Board (Map)

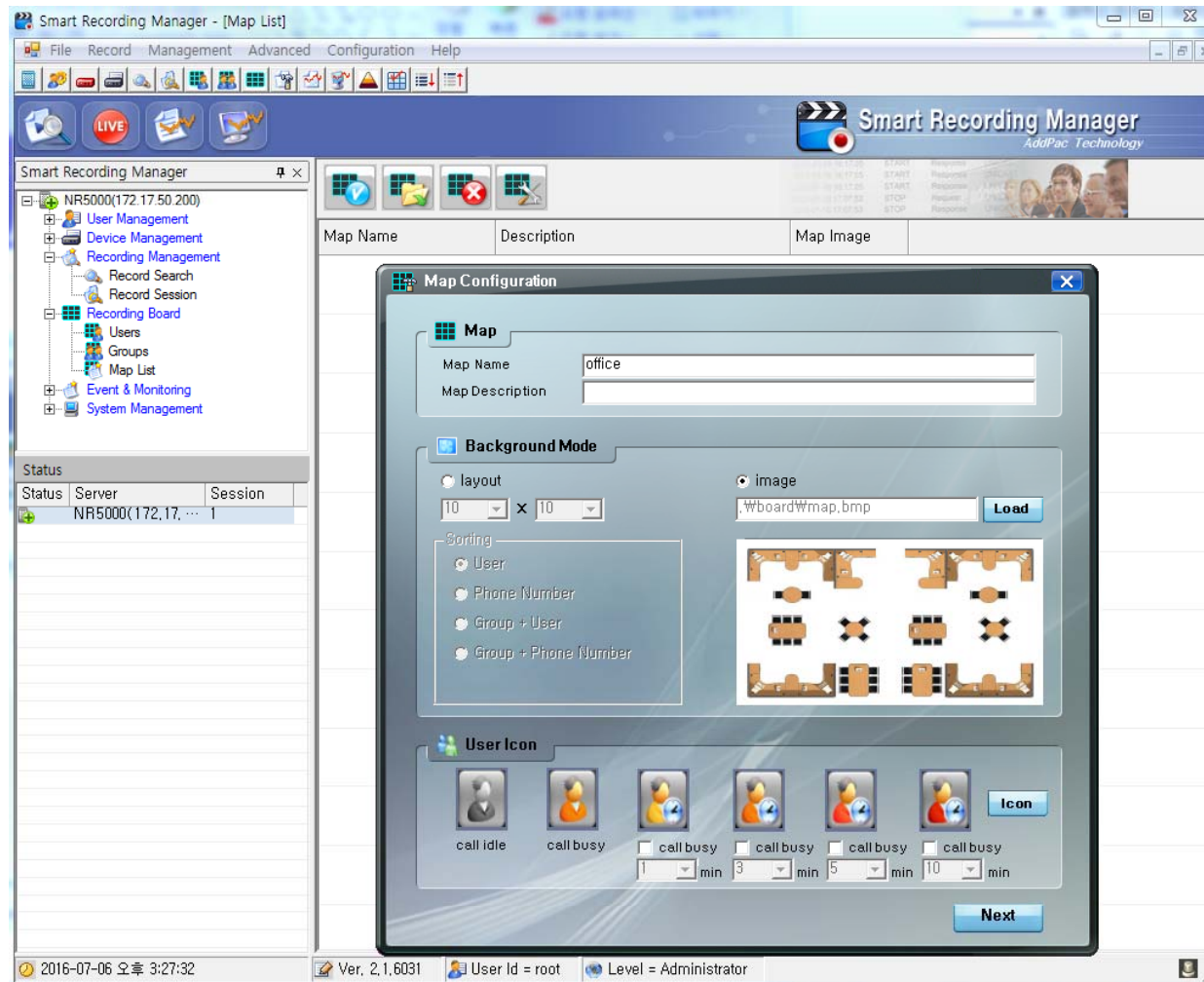

Recording Board

(Map Editing and user monitoring)

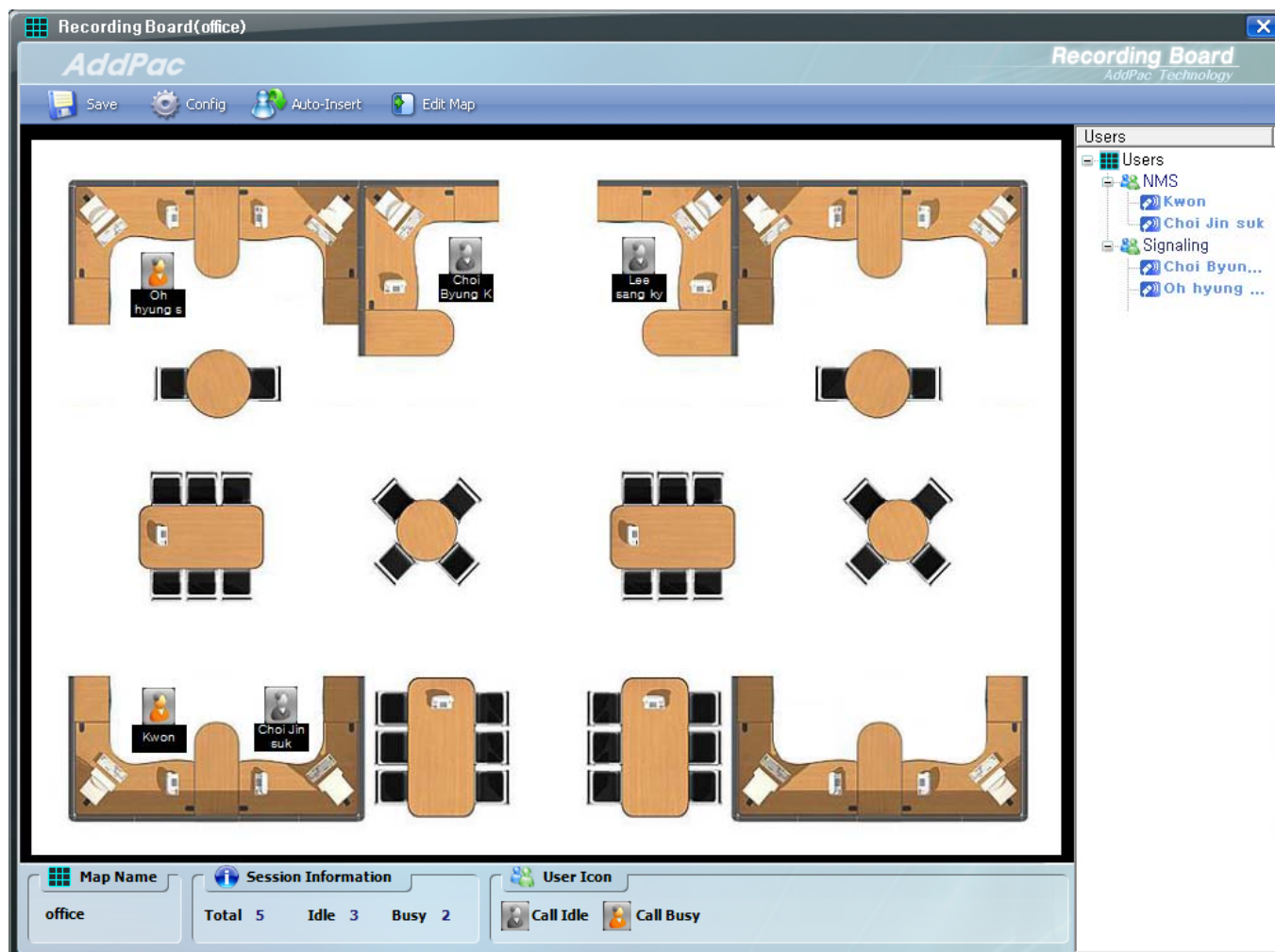

Smart Recording File Manager

(Recorded Call List Search)

The screenshot displays the 'Smart Recording File Manager' application window. The interface includes a menu bar (File, Management, Help), a toolbar with icons, and a main search area. The search target is set to 'Local Database', and the search period is from '2016년 1월 1일' to '2016년 7월 6일'. The search results are displayed in a table with columns: Start Time, End Time, Duration, Calling Number, Calling User, Called Number, Called User, and Recording Source. A tree view on the left shows the directory structure for 'Remote Database (172.17.50.200)' and 'Local Database', with folders for years (2016) and months (06, 07). Red arrows point from text labels to specific parts of the interface: 'Server Recording History (Year/Month/Day)' points to the 'Remote Database' tree, 'Backup PC Recording History (Year/Month/Day)' points to the 'Local Database' tree, and 'Searched Recording History' points to the search results table.

Start Time	End Time	Duration	Calling Number	Calling User	Called Number	Called User	Recording Source
2016-07-05 10:30:...	2016-07-05 10:30:16	00:00:00	1000		3000		172.16.9.29 ...
2016-07-05 12:47:...	2016-07-05 12:47:45	00:00:00	1000		3000		172.16.9.29 ...
2016-07-05 12:50:...	2016-07-05 12:50:28	00:00:00	1000		3001		172.16.9.29 ...
2016-07-05 12:50:...	2016-07-05 12:50:40	00:00:00	1000		3001		172.16.9.29 ...
2016-07-05 12:51:...	2016-07-05 12:51:05	00:00:00	1000		3001		172.16.9.29 ...
2016-07-05 12:51:...	2016-07-05 12:51:09	00:00:00	1000		3000		172.16.9.29 ...
2016-07-05 12:53:...	2016-07-05 12:53:09	00:00:00	1000		3001		172.16.9.29 ...
2016-07-05 14:10:...	2016-07-05 14:10:01	00:00:00	1000		3001		172.16.9.29 ...
2016-07-05 14:11:...	2016-07-05 14:11:27	00:00:00	1000		3001		172.16.9.29 ...
2016-07-05 14:12:...	2016-07-05 14:12:42	00:00:00	1000		3001		172.16.9.29 ...
2016-07-05 14:13:...	2016-07-05 14:13:03	00:00:00	1000		3001		172.16.9.29 ...

Server Recording History
(Year/Month/Day)

Backup PC Recording History
(Year/Month/Day)

Searched Recording History

Smart Recording File Manager (Configuration)

The screenshot displays the Smart Recording File Manager interface. A configuration dialog box is open, showing the following sections:

- FTP Information:** Port (21), Username (root), Password (*****).
- Repository Directory:** File path: C:\AddPac\RecordingBackupData.
- Media Player:** Player path: C:\Program Files\VideoLAN\VLC\vlc.exe.

Below the media player path, there is a red warning message: "Select the absolute path for executable media player. Click below link to VLC download. <http://www.videolan.org/vlc/download-windows.html>".

The background window shows a search results table with columns: Start Time, End Time, Duration, Calling Number, Calling User, Called Number, Called User, and Recording Source. The table contains two rows of data for recordings on 2016-07-05.

Start Time	End Time	Duration	Calling Number	Calling User	Called Number	Called User	Recording Source
2016-07-05 10:30:...	2016-07-05 10:30:16	00:00:00	1000		3000		172.16.9.29
2016-07-05 12:47:...	2016-07-05 12:47:45	00:00:00	1000		3000		172.16.9.29

The status bar at the bottom shows: 2016-07-06 오후 3:40:26, version 1.2.6031, 172.17.50.200:9200, root, Waiting, Next Backup Time(2016-07-08 오전 3:00:00).

Smart Recording File Manager

(Call List Properties)

The screenshot displays the Smart Recording File Manager interface. The main window shows a search for recordings in a remote database from July 1st to July 6th, 2016. A context menu is open over a selected recording entry, with the 'Properties' option highlighted. A 'Recording Session Information' dialog box is also open, showing details for two recordings.

Start Time	End Time	Duration	Calling Number	Calling User	Called Number	Called User	Recording Source
2016-07-05 10:30:...	2016-07-05 10:30:16	00:00:00	1000		3000		172.16.9.29 ...
2016-07-05 12:47:...	2016-07-05 12:47:45	00:00:00	1000		3000		172.16.9.29 ...
2016-07-05 12:50:...	2016-07-05 12:50:28	00:00:00	1000		3001		172.16.9.29 ...
2016-07-05		00:00:00	1000		3001		172.16.9.29 ...
2016-07-05		00:00:00	1000		3001		172.16.9.29 ...
2016-07-05		00:00:00	1000		3000		172.16.9.29 ...
2016-07-05		00:00:00	1000		3001		172.16.9.29 ...
2016-07-05		00:00:00	1000		3001		172.16.9.29 ...
2016-07-05		00:00:00	1000		3001		172.16.9.29 ...
2016-07-05 14:12:...	2016-07-05 14:12:42	00:00:00	1000		3001		172.16.9.29 ...
2016-07-05 14:13:...							

Filename	Start Time	End Time	Duration	Size	Audio Codec	Transcoding Codec
40003020160706005117...	2016-07-06 09:51:17	2016-07-06 09:51:31	00:00:14	1,763 KB	G711U	G711U
0003020160706005117...	2016-07-06 09:51:17	2016-07-06 09:51:31	00:00:14	1,763 KB	G711U	G711U

Smart Recording File Manager

(Server to Local Backup)

The screenshot displays the 'Smart Recording File Manager' application window. A 'Download' dialog box is open, showing a list of 16 files to be downloaded from a remote database to a local directory. The dialog includes a table with columns for File Name, Duration, Size, DateTime, and Status. Below the table, there is a 'Download Directory' field set to 'C:\AddPac\RecordingBackupData', a progress bar showing 0/0 Bytes received and 31,875,502 Bytes total, and a 'Delete files after download' checkbox. The main application window shows a tree view of the 'Remote Database' with folders for years (2016) and months (06, 07), and a table of recording data with columns for 'Called User' and 'Recording Source'.

File Name	Duration	Size	DateTime	Status
/home/callrecfiles/20160706/0/00...	00:00:13	1,492 KB	2016-07-06 09:2...	Wait
/home/callrecfiles/20160706/0/00...	00:00:13	1,492 KB	2016-07-06 09:2...	Wait
/home/callrecfiles/20160706/0/00...	00:02:13	14,519 KB	2016-07-06 09:2...	Wait
/home/callrecfiles/20160706/0/00...	00:02:13	14,519 KB	2016-07-06 09:2...	Wait
/home/callrecfiles/20160706/0/00...	00:00:00	0 KB	2016-07-06 09:4...	Wait
/home/callrecfiles/20160706/0/00...	00:00:00	0 KB	2016-07-06 09:4...	Wait
/home/callrecfiles/20160706/0/00...	00:00:46	5,750 KB	2016-07-06 09:4...	Wait
/home/callrecfiles/20160706/0/00...	00:00:46	5,750 KB	2016-07-06 09:4...	Wait
/home/callrecfiles/20160706/0/00...	00:00:43	4,916 KB	2016-07-06 09:4...	Wait
/home/callrecfiles/20160706/0/00...	00:00:43	4,916 KB	2016-07-06 09:4...	Wait
/home/callrecfiles/20160706/0/00...	00:00:14	1,763 KB	2016-07-06 09:5...	Wait
/home/callrecfiles/20160706/0/00...	00:00:14	1,763 KB	2016-07-06 09:5...	Wait
/home/callrecfiles/20160706/1/00...	00:00:14	2,018 KB	2016-07-06 10:4...	Wait

Smart Recording File Manager

(Recorded Call List Search)

The screenshot displays the 'Smart Recording File Manager' application interface. A 'Search Filter' dialog box is open, allowing users to refine search results. The dialog includes a 'Record Time' section with start and end date/time pickers, and a 'Filter' section with multiple rows of dropdown menus for 'Filter Name', 'Rule', and 'Search' values. The main window shows a tree view of databases and a table of recorded calls.

Start Time	End Time	Duration	Calling Number	Calling User	Called Number	Called User	Recording Source
2016-07-06 12:04:33	2016-07-06 12:04:34	00:00:09	5055		5155		172.17.50.26 ...
2016-07-06 12:04:34	2016-07-06 12:04:35	00:00:09	5067		5167		172.17.50.26 ...
2016-07-06 12:04:35	2016-07-06 12:04:38	00:00:09	5085		5185		172.17.50.26 ...
2016-07-06 12:04:36	2016-07-06 12:04:42	00:00:09	5098		5198		172.17.50.26 ...

Search Filter Dialog:

- Record Time: Start [2016-07-06] 오전 12:00:00, End [2016-07-06] 오후 3:54:07
- Filter:

Calling Number	IsExactly	5067	<Blank>
<Blank>	IsExactly		<Blank>
<Blank>	IsExactly		<Blank>
<Blank>	IsExactly		<Blank>
<Blank>	IsExactly		<Blank>
- Recording Service Unavailable Files (not G711U codec)
* It may take a long time.

Smart Recording File Manager

(Periodical Backup)

The screenshot displays the 'Smart Recording File Manager' application window. The main interface includes a menu bar (File, Management, Help), a toolbar with icons, and a search bar. The search criteria are set to 'Local Database', with a start date of '2016년 1월 1일 금요일' and an end date of '2016년 7월 6일 수요일'. The search results are displayed in a table with columns: Start Time, End Time, Duration, Calling Number, Calling User, Called Number, Called User, and Recording Source. Two records are visible, both with a duration of 00:00:09.

A 'Schedule Setting' dialog box is open in the foreground. It contains the following settings:

- Recording Source:** A tree view showing a 'Source' folder with three sub-items: '172.17.207.207', '172.17.50.26', and '172.17.50.80'. The '172.17.50.26' and '172.17.50.80' items are checked.
- Scheduler Run / Stop:** Checked.
- Schedule Date:**
 - Daily : Every 1 Days
 - Weekly : Every 1 Weeks (Sunday selected)
 - Monthly : Day 1
- Start Time:** 03:00:00
- Option:**
 - Delete files after download
 - Download to file overwrite
- Directory:** C:\AddPac\RecordingBackupData

The dialog box has 'OK' and 'Cancel' buttons at the bottom right.

The status bar at the bottom of the application window shows: '2016-07-06 오후 3:56:43', 'version 1.2.6031', '172.17.50.30:9200', 'root', 'Waiting', and 'Next Backup Time(2016-07-08 오전 3:00:00)'.

MAP based SIP Emergency Call Center System (AP-MSCS)



MAP based SIP Emergency Call Service Overview

- JavaScript based Interactive MAP Service
- Integrated Security Management Service via MAP based Device Overlay Display
- SIP Emergency Call Phone, Video Phone, etc, Geographical Display on MAP for Instinctive Control Service
- MAP Editor Service (Background Image, Device Lists, etc)
- MAP based Emergency Call IP Video Intercom Status Display
- Zoom to Area, Double Click Zoom, Scroll Wheel Zoom, etc
- Tile Layer, etc

MAP based SIP Emergency Call Service Overview (Example)

Smart Security Manager PM 12:13

수원시 지도

구운사거리
상태 : 비상통화 연결중
Link : linked
Last : 2017/02/09 15:20:37

ID	시간	단계	구분	지역	장치	메시지	위치 정보
1747001	2017-09-27 11:17:20	주의	시스템	권선구	EIP60	연결 끊김	권선구 탑동 탑동사거리
1747000	2017-09-27 09:11:20	주의	시스템	팔달구	EIP60	연결 끊김	팔달구 우만동 효성사거리

장치

- Camera 0/0
- Emergency Intercom 1/40
- Sensor 0/0

MAP based SIP Emergency Call Service Overview (Tile Layer Example)

The screenshot displays the Smart Security Manager interface. At the top, it shows the title 'Smart Security Manager' and the time 'PM 12:13'. Below the title bar, there are navigation icons for '상황판' (Status), '관리소' (Control Room), '장치' (Device), '알림' (Alarm), '작업' (Operation), and '이력' (History).

The main area is divided into two map panes: '팔달구 지도' (Paldal-gu Map) on the left and '장안구 지도' (Jangang-gu Map) on the right. The Paldal-gu map has a pop-up window for '고동동' (Godong-dong) with the following details:

- 상태: 비상통화 통화중 (Status: Emergency Call in Progress)
- Link: linked
- Last: 2017/02/09 15:20:37

At the bottom, there is an '알림' (Alarm) table and a '장치' (Device) status panel.

ID	시간	단계	구분	지역	장치	메시지	위치 정보
1747001	2017-09-27 11:17:20	주의	시스템	권선구	EIP60	연결 끊김	권선구 탑동 탑동사거리
1747000	2017-09-27 09:11:20	주의	시스템	팔달구	EIP60	연결 끊김	팔달구 우만동 효성사거리

The '장치' (Device) panel shows the following status:

- Camera: 0/0
- Emergency Intercom: 1/40
- Sensor: 0/0

MAP based SIP Emergency Call Service Overview (Tile Layer Example)

Smart Security Manager

PM 12:13

상황판 관리소 장치 알람 5 작업 이력

팔달구 지도

장안구 지도

알람	ID	시간	단계	구분	지역	장치	메시지	위치 정보
	1747001	2017-09-27 11:17:20	주의	시스템	권선구	EIP60	연결 끊김	권선구 합동 합동사거리
	1747000	2017-09-27 09:11:20	주의	시스템	팔달구	EIP60	연결 끊김	팔달구 우만동 효성사거리

장치

- Camera 0/0
- Emergency Intercom 1/40
- Sensor 0/0

MAP based SIP Emergency Call Service Overview (MAP Editor Service)

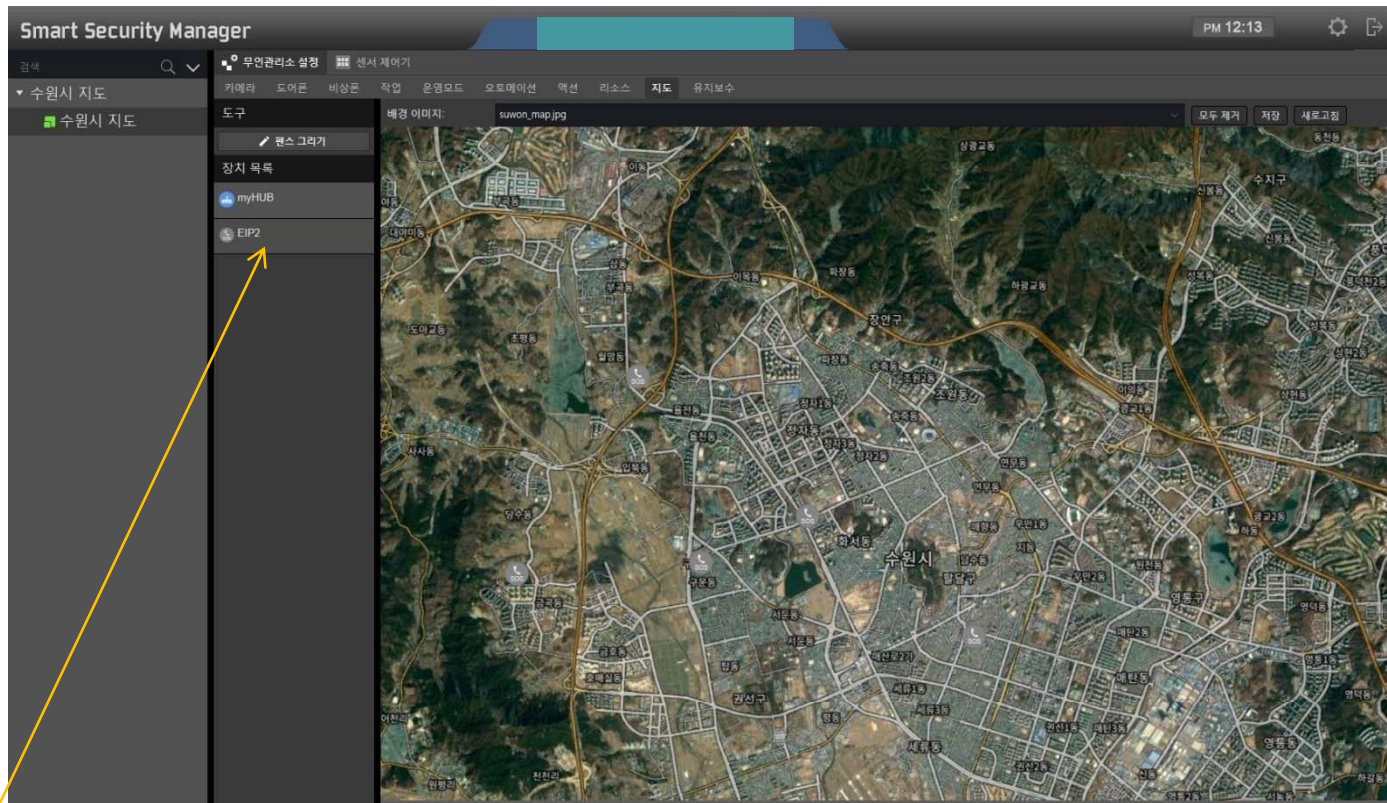

Device Lists : IP
Emergency Call Phone, IP
paging terminal etc

AddPac

MAP based SIP Emergency Call Service Overview (MAP Editor Service)

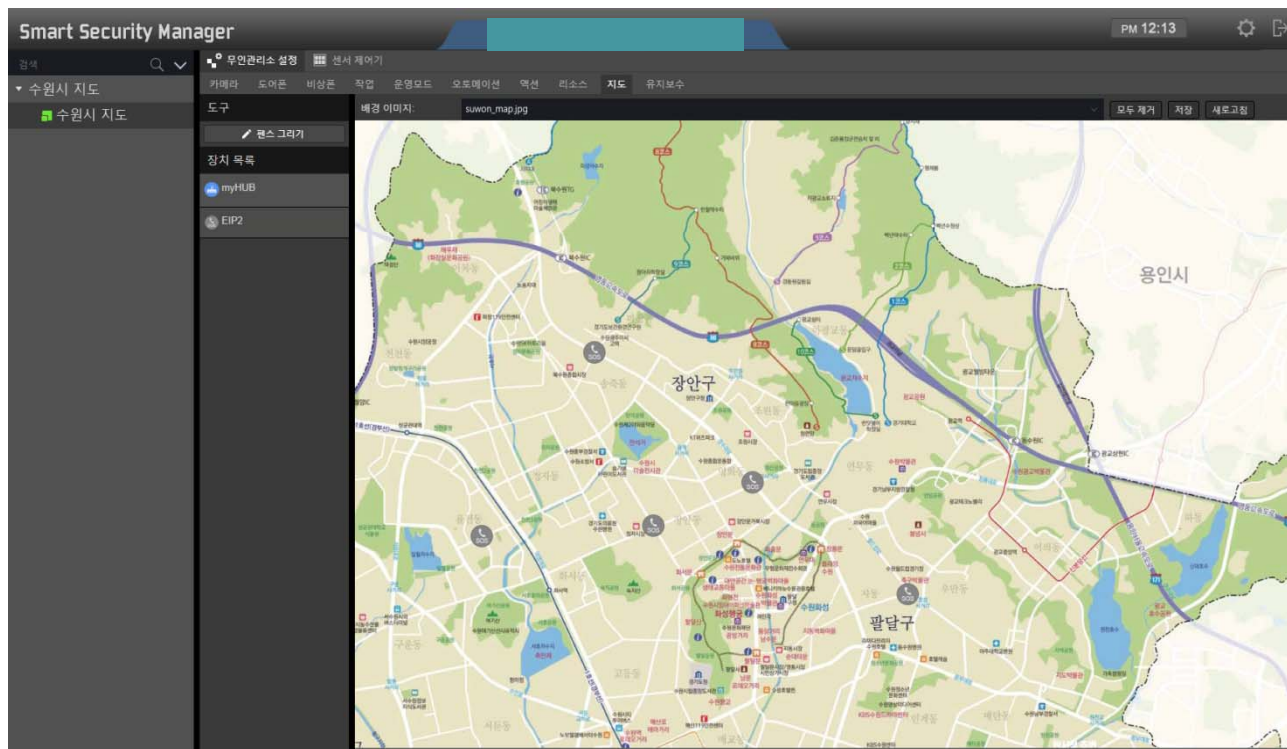

GPS based Embedded NTP Server for Time Sync. AP-GTR1000



Contents

- Product Overview
- Hardware Specification
- Simple NTP (Network Time Protocol)
- Network Diagram



Product Overview

AP-GTR1000 IP based GPS Time Receiver Terminal

- High Performance GPS Time Receiver Terminal Solution
- IP based GPS Time Receiver (Location Free, etc)
- NTP (Network Time Protocol) Sever Solution
- Dual RS232 Port for GPS Time Information Transmission
- LCD Display for GPS Time Information
- External Antenna Interface Support
- Various Antenna Support for GPS Signal
- Blue LAMP for Device Status
- Smart Web Manager for System Configuration & Management
- Window, Linux Simple Socket API Program Support
- Firmware Upgradeable Architecture
- Broadcasting Solution with Outstanding Network Service Capability

Hardware Specification

AP-GTR1000 IP based GPS Time Receiver Terminal

RISC
CPU

High-end
GPS

- RISC Microprocessor Computing Power
- High-end GPS Module Hardware Architecture
- One(1) Module Slot for GPS Module
- LCD Display at Front Side
- Blue LAMP
- One(1) 10/100Mbps Fast Ethernet Interface
- Dual(2) DB-9 RS232C Interface
- Internal Power Supply
- Rack Mount Bracket (Option)
- GPS Antenna (Option)
- Option Module : AP-GPS-RS232
 - Two(2) DB-9 RS232C Interface Port
 - GPS Antenna Interface Port

Hardware Specification

AP-GTR1000 IP based GPS Time Receiver Terminal

RISC
CPU

High-end
GPS

Front Side



One(1) 10/100Mbps
LAN

RS232C Console

Status LCD

On-Air Blue LAMP
& Switch

Hardware Specification

AP-GTR1000 IP based GPS Time Receiver Terminal

RISC
CPU

High-end
GPS

Back Side

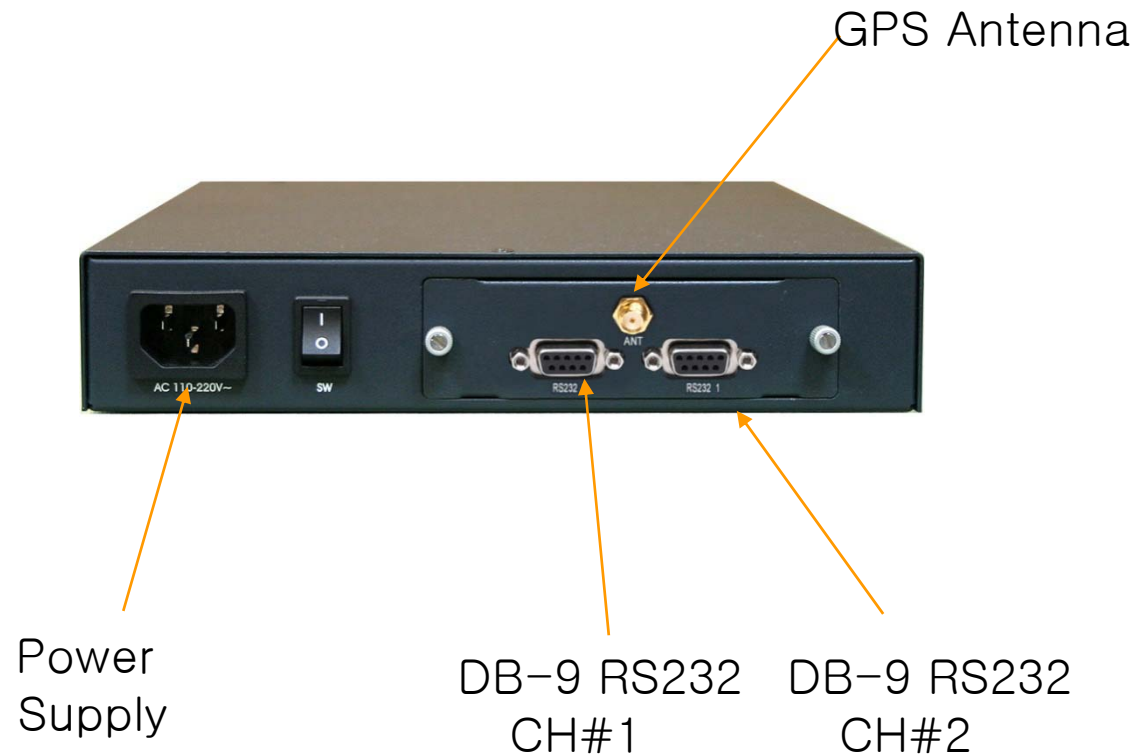

Hardware Specification

AP-GTR1000 IP based GPS Time Receiver Terminal

RISC
CPU

High-end
GPS

GPS Antenna



SNTP (Simple Network Time Protocol)

- Transport : UDP (port number 123)
- Protocol Version : 4
- Client/Server Mode

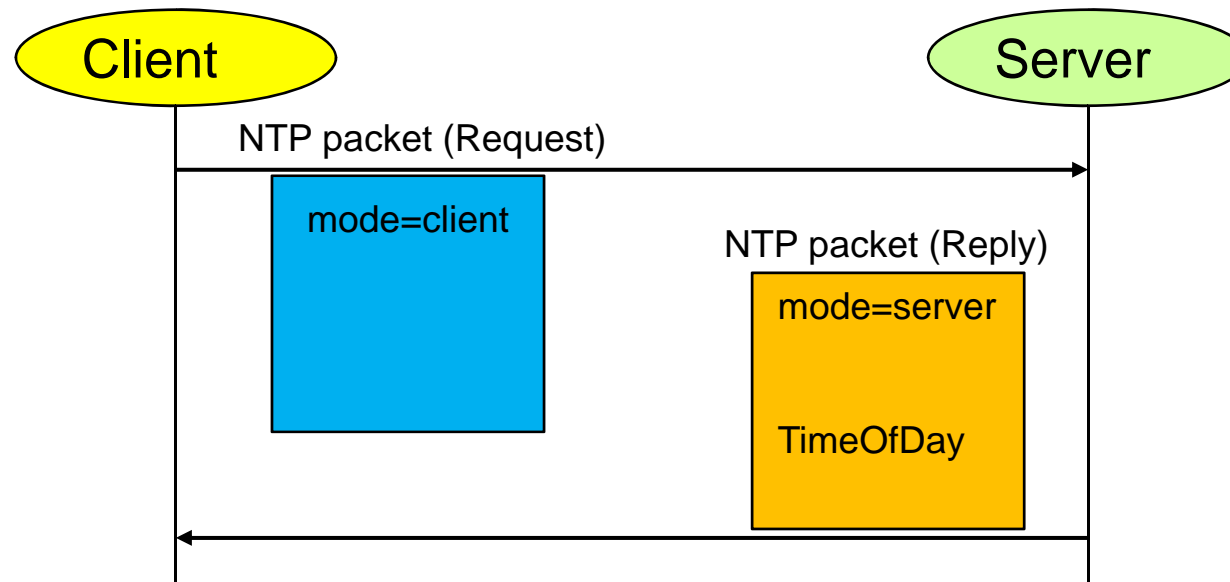

SNTP (Simple Network Time Protocol)

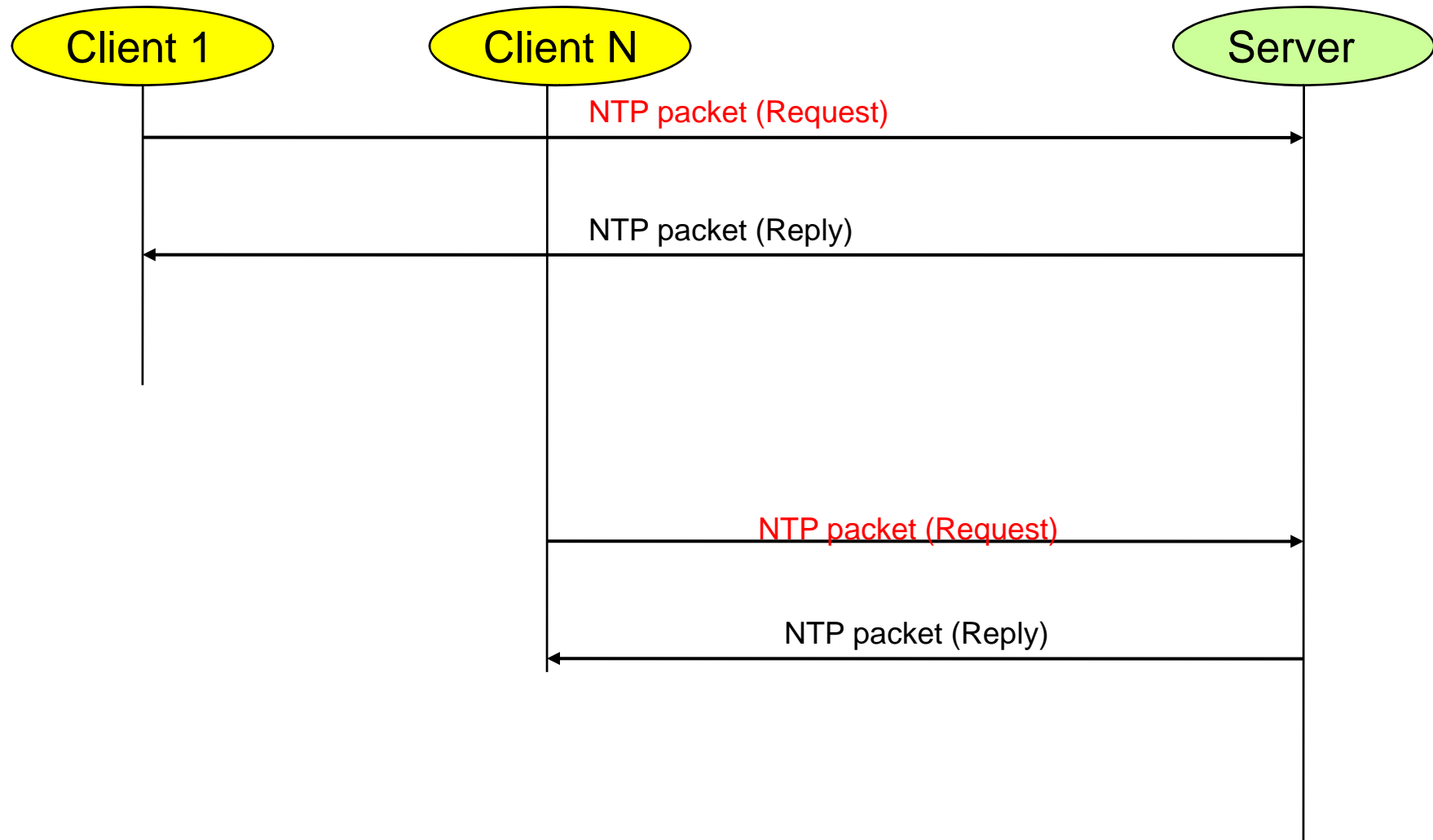

SNTP (Simple Network Time Protocol)

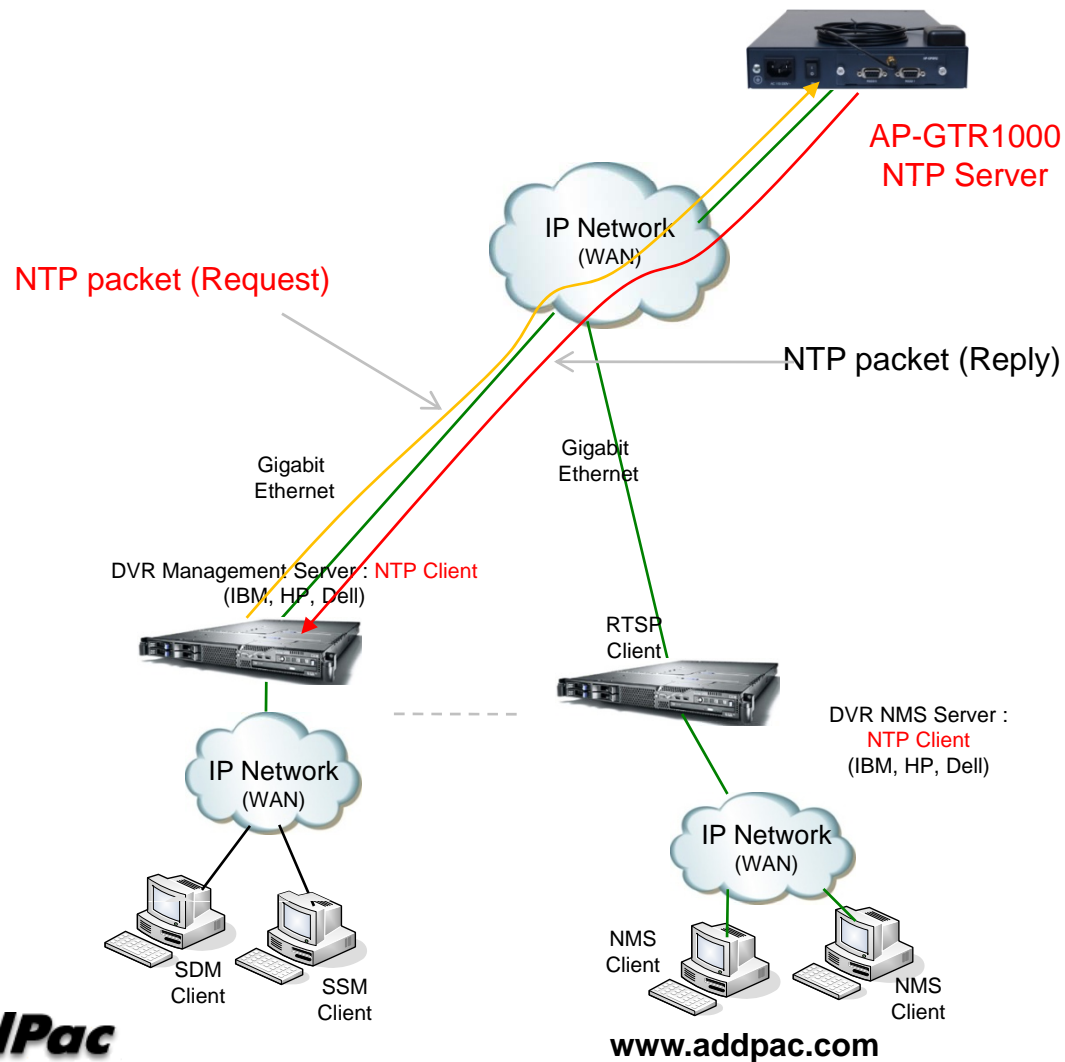



Thank you!

AddPac Technology Co., Ltd.
Sales and Marketing

Phone +82.2.568.3848 (KOREA)

FAX +82.2.568.3847 (KOREA)

E-mail : sales@addpac.com