

AP-TAS200 Time & Attendance IP Voice Door Phone

High Performance Time & Attendance IP Voice Door Phone Solution



AddPac

AddPac Technology

Sales and Marketing

www.addpac.com

Contents

- Product Overview
- Product Highlights
- Hardware Specification
- Software Service
- Audio & Voice Service and Features
- Smart Web Manager
- Time & Attendance Web Manager
- Application Area
- Ordering Information

Product Overview

AP-TAS200 Time & Attendance IP Voice Door Phone

- Smart Time & Attendance IP Voice Door Phone Solution
- High Performance SIP Voice Door Phone Solution
- Voice Call Button, TFT Color LCD, Internal MIC & Speaker
- High Quality 3.5 Inch LCD, 320 x 240 Video Resolution
- Fingerprint Recognition Support
- RF Card Support
- SIP VoIP Signaling Stack Embedded
- High-performance Video/Voice Codec Support
 - H.264/MPEG4, G.711, etc
- One(1) 10/100Mbps Fast Ethernet
- PoE(Power over Ethernet) Support
- High Quality Speaker Phone Features
- Powerful Acoustic Echo Canceller Chip Embedded
- Powerful Network Protocols (PPPoE, DHCP, Static Routing, etc)
- Firmware Upgradeable Architecture
- Advanced Voice QoS Mechanism

Product Highlights

AP-TAS200 Time & Attendance IP Voice Door Phone

Smart Time & Attendance IP Voice Door Phone

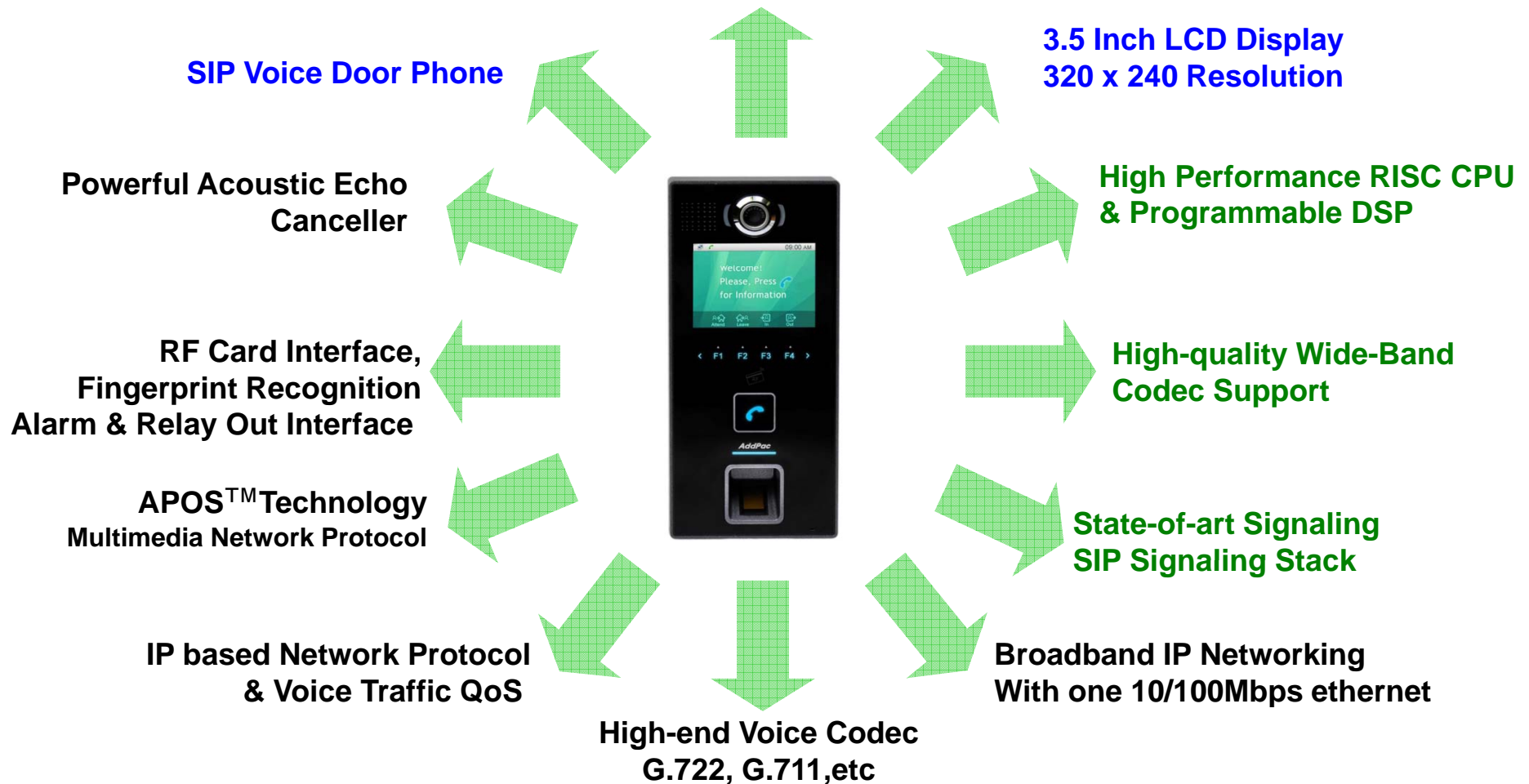

AddPac

www.addpac.com

Multimedia Service

AP-TAS200 Time & Attendance IP Voice Door Phone



- APOS : AddPac Internetworking Operating System
- OSD : On- Screen Display
- EMS : Element Management System

Hardware Specification

AP-TAS200 Time & Attendance IP Voice Door Phone

RISC
CPU

High-end
DSP

- RISC+DSP Microprocessor Computing Power
- Audio and Voice Interface
 - Internal MIC
 - Internal Speaker
- TFT Color LCD Interface
 - 3.5 Inch LCD, 320 x 240 Video Resolution
- Network Interface
 - One(1) 10/100Mbps Fast Ethernet
- Fingerprint Recognition Interface
- RF Card Interface
- Alarm & Relay Out Interface (door open, etc)
- RS232/RS485 Interface
- External RCA Audio Line Out and MIC In (back side)
- Steel Chassis
- Power Supply
 - Power over Ethernet (Option)
 - External Power Supply



Hardware Specification

AP-TAS200 Time & Attendance IP Voice Door Phone

RISC
CPU

High-end
DSP

- **Acoustic Echo Canceller**
 - Full-duplex operation during double-talk situations
 - One channel AEC, one channel LEC up to 256ms shared
 - Cancels echoes with up to 10dB echo return
 - Advanced noise reduction(up to 20dB)
- **Speaker**
 - Impedance : 8 +-15%ohm at 1kHz, 1.0 Vrms
 - Sound Pressure : 90 +- 3dB at 0.1W/10 CM
at 800Hz, 1.0kHz, 1.2kHz, 1.5kHz
 - Resonance Level : 550Hz +- 20%Hz at Fo Hz, 1.0Vrms
 - Frequency Range : Fo Hz ~20kHz
 - Input Power : Normal : 1.0 W, Max : 2.0W
- **Audio Amplifier**
 - 1-W BTL Output(5V, 0.11 % THD+N)
 - Uncompensated Gains of 2 to 20 (BTL Mode)
 - Thermal and Shot-circuit Protection
 - High Supply Ripple Rejection Ratio
- **PoE(Power over Ethernet)**
 - IEEE802.3af compliant
 - Input voltage range 36V to 57V
 - Short-circuit Protection

Hardware Specification

AP-TAS200 Time & Attendance IP Voice Door Phone

RISC
CPU

High-end
DSP

- LCD Controller
 - One-Chip Solution for amorphous TFT-LCD
 - Support resolution up to 240xRGBx320
 - Built-in 172800 bytes internal RAM
 - 6,8,16, and 18-bit RGB Interface
 - Resize Function (x ½, x ¼)
 - On-Chip Power Management System

Hardware Specification

AP-TAS200 Time & Attendance IP Voice Door Phone

RISC
CPU

High-end
DSP

- RF Card Sensor
 - Protocol Supported
 - ISO14443A/B all bit rates
 - > 106,212,424 and 848 kbps
 - Compatible to MiFare Classic
 - ISO15693 all modes
 - > 1.65/6.6 & 26.5 kbps
 - > Uplink 1 & 2 sub-carrier
 - Receiver
 - Rx Sensitivity down to 1mVrms
 - Rx Automatic Gain Control
 - Accept external baseband signal from external circuitry for frame level processing
 - Integrated signal strength indicator (SSI)
 - On-Chip Framing handler for supported standard
 - Transmitter
 - Typical proximity operating distance up to 100mm.
 - Software configurable modulation index
 - Maximum driving current up to 200 mA/PIN @ 5V
 - Accept external baseband signal for RF modulation
 - Wide Transmitter driver supply range from 2.7~7.0V

RF Card Sensor

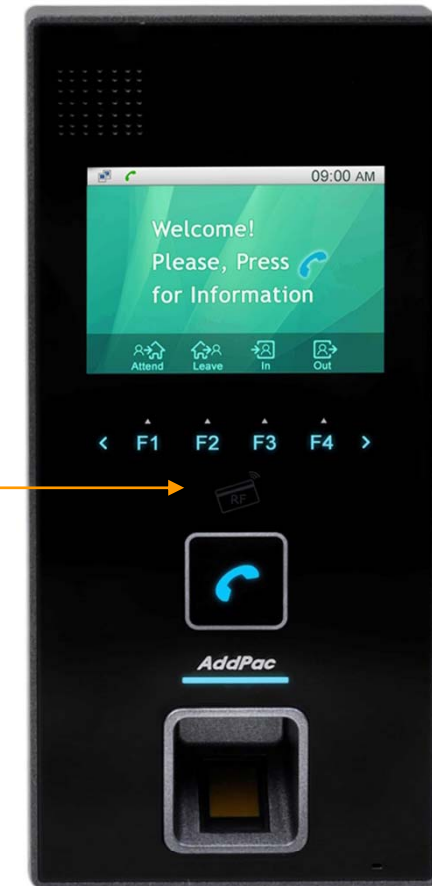

Hardware Specification

AP-TAS200 Time & Attendance IP Voice Door Phone

RISC
CPU

High-end
DSP

- Fingerprint Recognition
 - Sensor Type : Capacitive
 - Resolution(dpi) : 508
 - Sensing Area(mm) : 12.8 x18.0
 - Image Size(pixel) : 256 x 360
 - CPU : 400MHz DSP
 - Flash Memory : 4MB
 - ERR : < 0.1%
 - Enrollment Time : 800msec
 - 1:1 Verification Time : 800msec
 - 1:1000 Identification Time : 970msec
 - Template Size : 256~384bytes (configurable, 384bytes default)
 - Template Capacity : 9,000
 - Encryption : 256bit AES



Fingerprint Recognition

Hardware Specification

AP-TAS200 Time & Attendance IP Voice Door Phone

RISC
CPU

High-end
DSP

Front Side

Internal Speaker



TFT LCD Display

Time & Attendance Menu

Function & Direction Key

RF Card Sensor

SIP Voice Call Button

Status LED

Steel Chassis

Fingerprint Recognition

Internal MIC Input

AddPac

www.addpac.com

Hardware Specification

AP-TAS200 Time & Attendance IP Voice Door Phone

RISC
CPU

High-end
DSP

Back Side

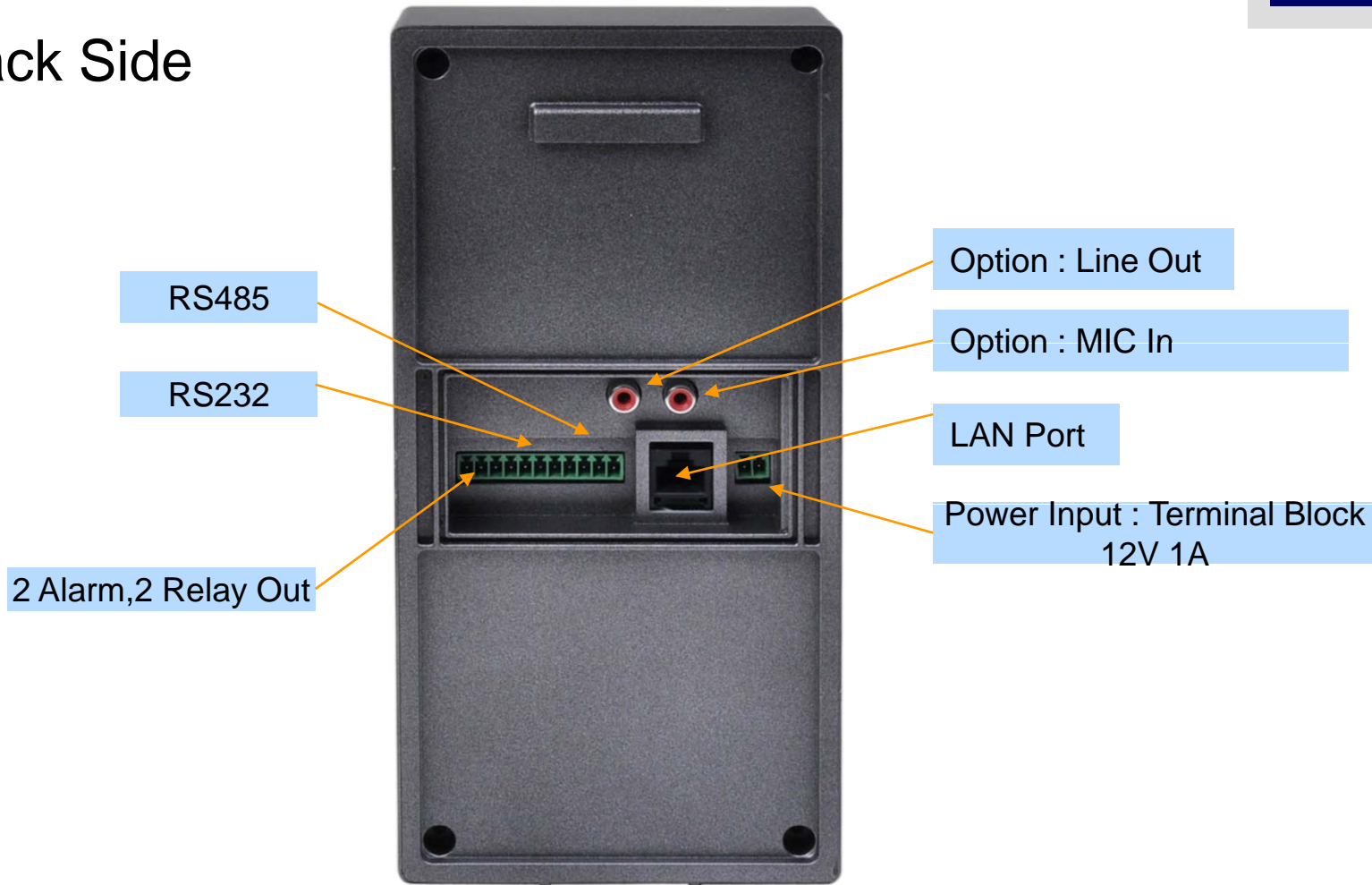

Hardware Specification

AP-TAS200 Time & Attendance IP Voice Door Phone

RISC
CPU

High-end
DSP

Power Supply

Terminal Block



12V 1A Power Adaptor

Example



Software Service

AP-TAS200 Time & Attendance IP Voice Door Phone

- **Built-in AddPac APOS Internetworking Software**
 - Scalability, Functionality, and Stability Features
 - VoiceTraffic QoS Control
- **Programmable Audio, and Voice Services**
 - Audio, and Voice Codec
- **Firmware Upgradeable DSP Architecture**
- **OSD (On-screen Display) Function Support**
- **Industry Standard IP based Network Protocol Features**

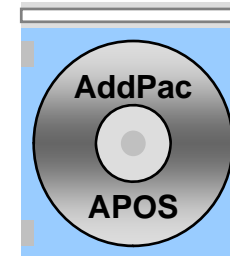

Audio & Voice Service and Features

AP-TAS200 Time & Attendance IP Voice Door Phone

- **Audio & Voice Networking Interface**
 - External Audio Line-Out Interface (RCA Connector)
 - External Audio MIC-In Interface (RCA Connector)
- **VoIP based Signaling Protocol Support**
 - SIP Signaling Protocol Stack
- **High-performance Audio & Voice Codec Support**
 - G.722, G.711, G.726 Audio Codec
- **Enhanced QoS Management Features for Voice Traffics**



Smart Web Manager (Example)

Smart Web Manager

AP-TAS200 Time & Attendance IP Voice Door Phone

- Main Screen
- System
 - Language
 - LAN Setup
 - DACS
 - Display
 - File Browser
- SIP Call & Media
 - SIP (Session Initiation Protocol)
 - Speed Dial
 - Media
- Miscellaneous
 - Door Control and Test
 - Network Test



Smart Web Manager : Main Screen

AP-TAS200 Time & Attendance IP Voice Door Phone

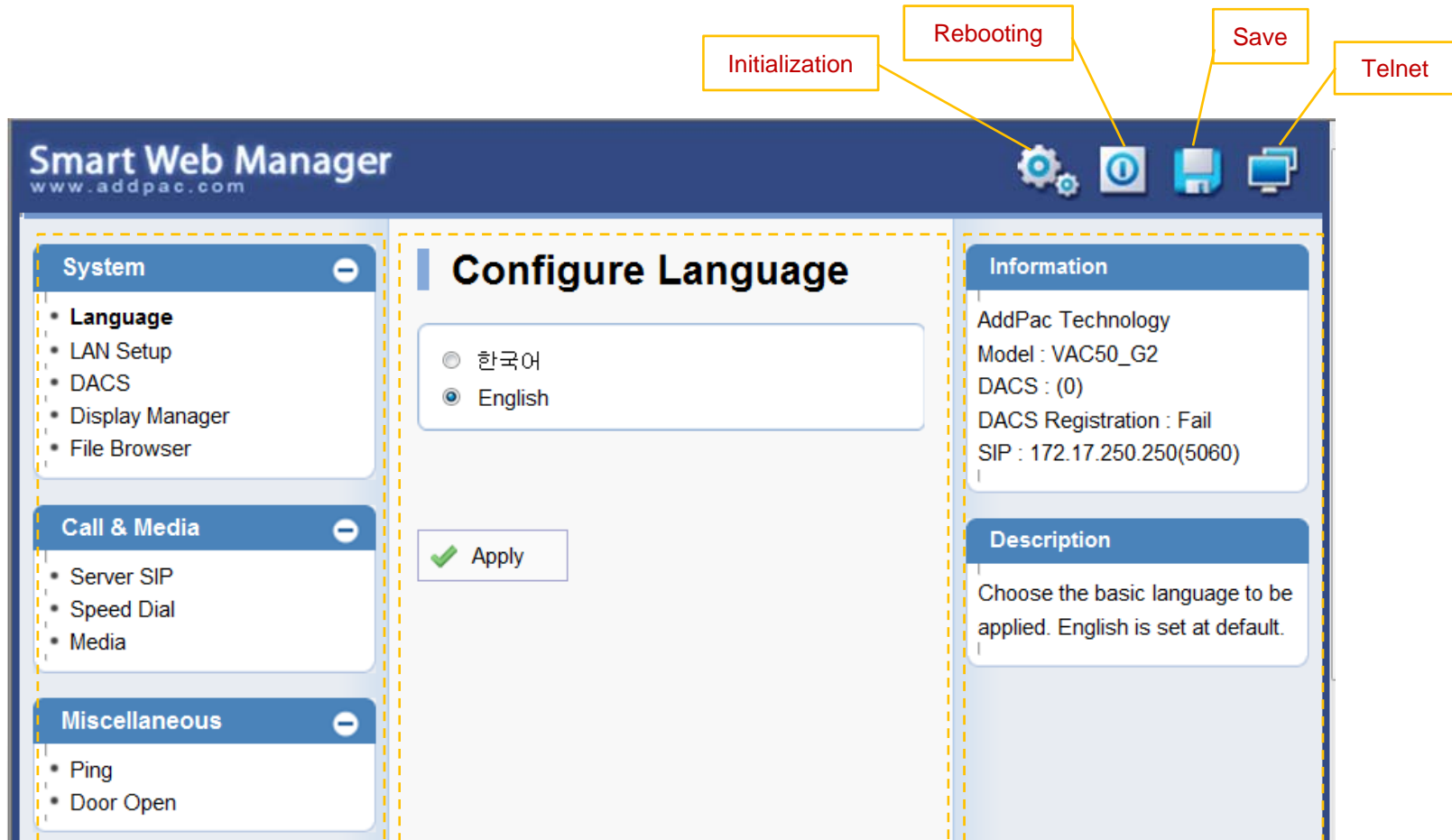

Menu Tree

Output Screen after
Menu Select

System Information and
Help Message

Smart Web Manager : SIP configuration

AP-TAS200 Time & Attendance IP Voice Door Phone

SIP (Session Initiation Protocol)

SIP server check if exist.

SIP Basic Information Display

Telephone Line Number and Password Configuration
Same Information is used when DACS is connected

Use SIP Server	<input checked="" type="radio"/> Yes <input type="radio"/> No
Primary SIP Server	<input type="text" value="172.17.250.250"/> <input type="text" value="5060"/> Server address and Port (default 5060)
Secondary SIP Server	<input type="text"/> <input type="text" value="5060"/> Server address and Port (default 5060)
Local Domain Name	<input type="text"/> (SIP userpart of authentication)
SIP Signaling Port	<input type="text" value="5060"/> (default 5060, between 1 to 65535)
Register Expiration	<input type="text" value="60"/> (in seconds, default 60, between 10 to 86400)
Session Re-Fresh	<input checked="" type="radio"/> INVITE <input type="radio"/> UPDATE
Session Expire Time	<input type="text" value="1800"/> (in seconds, default 1800, between 30 to 86400, 0 = disable)
Min-SE	<input type="text" value="1800"/> (in seconds, default 1800, between 30 to 86400)
Extension	<input type="text" value="1020"/> <input type="text"/> Extension Number, Password



Time & Attendance System Message Flow

Time & Attendance System Message Flow

Registration and KeepAlive

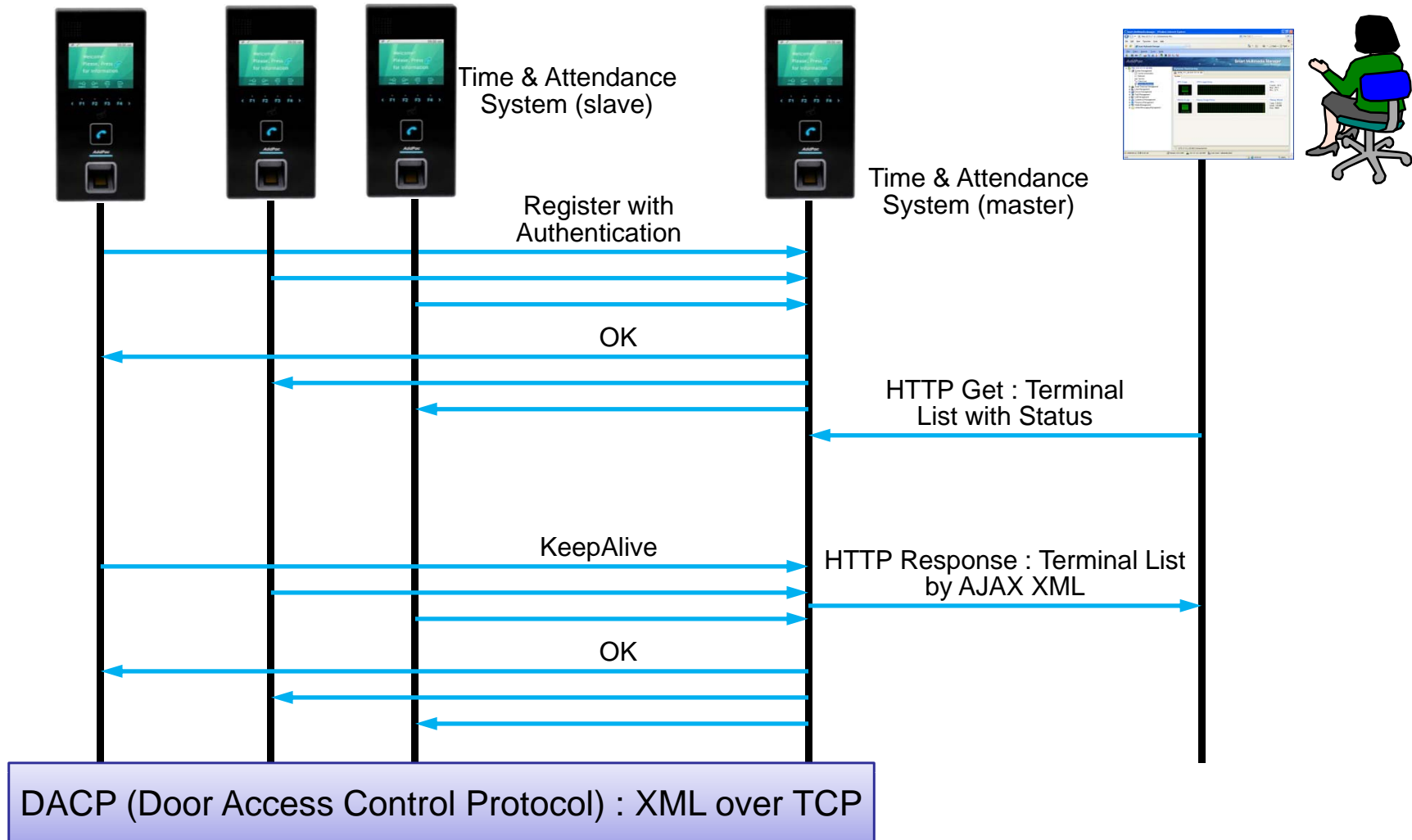

Time & Attendance System Message Flow

Access Privilege and Schedule Download

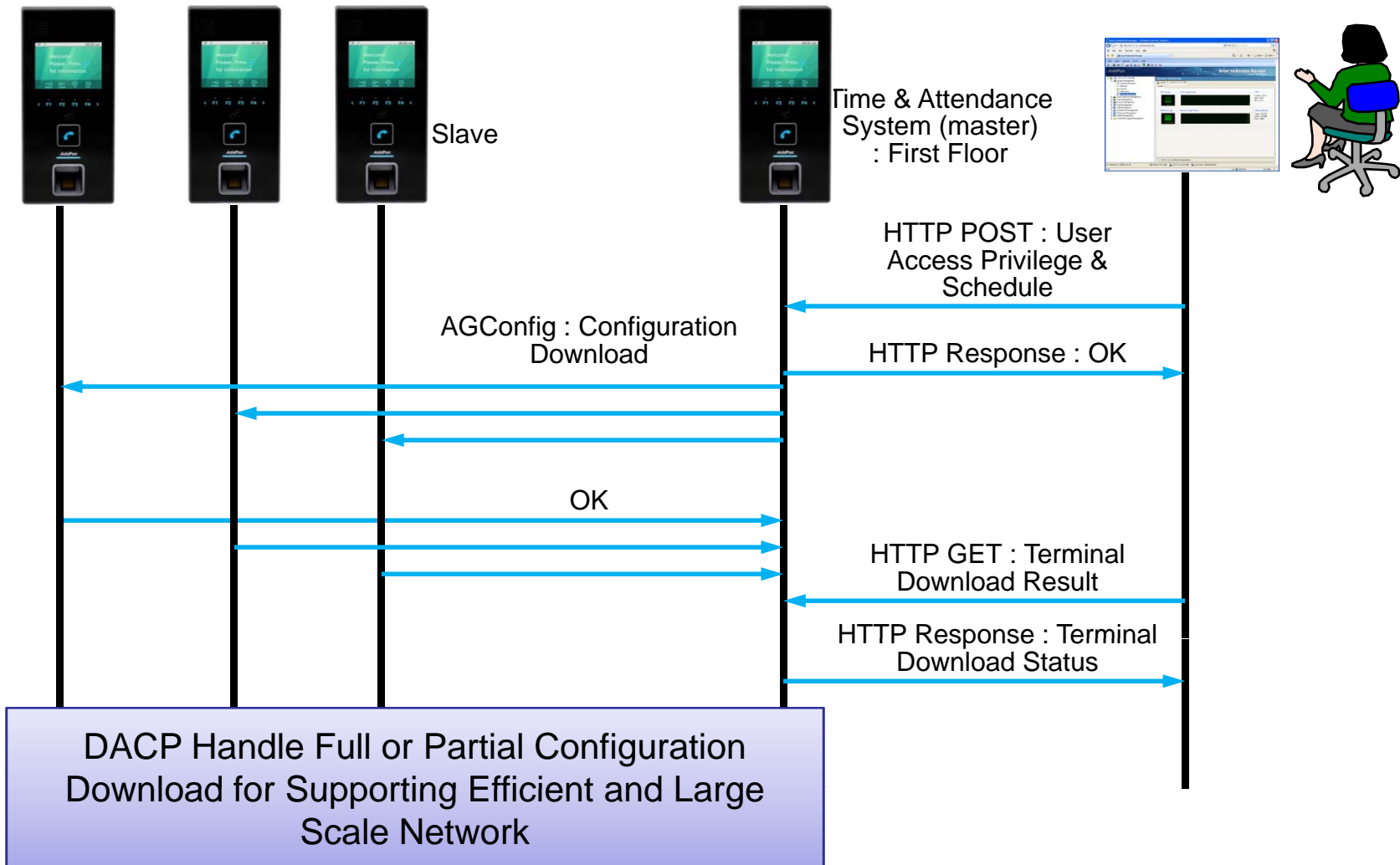

Time & Attendance System Message Flow

RF Card Read/Write and Registration

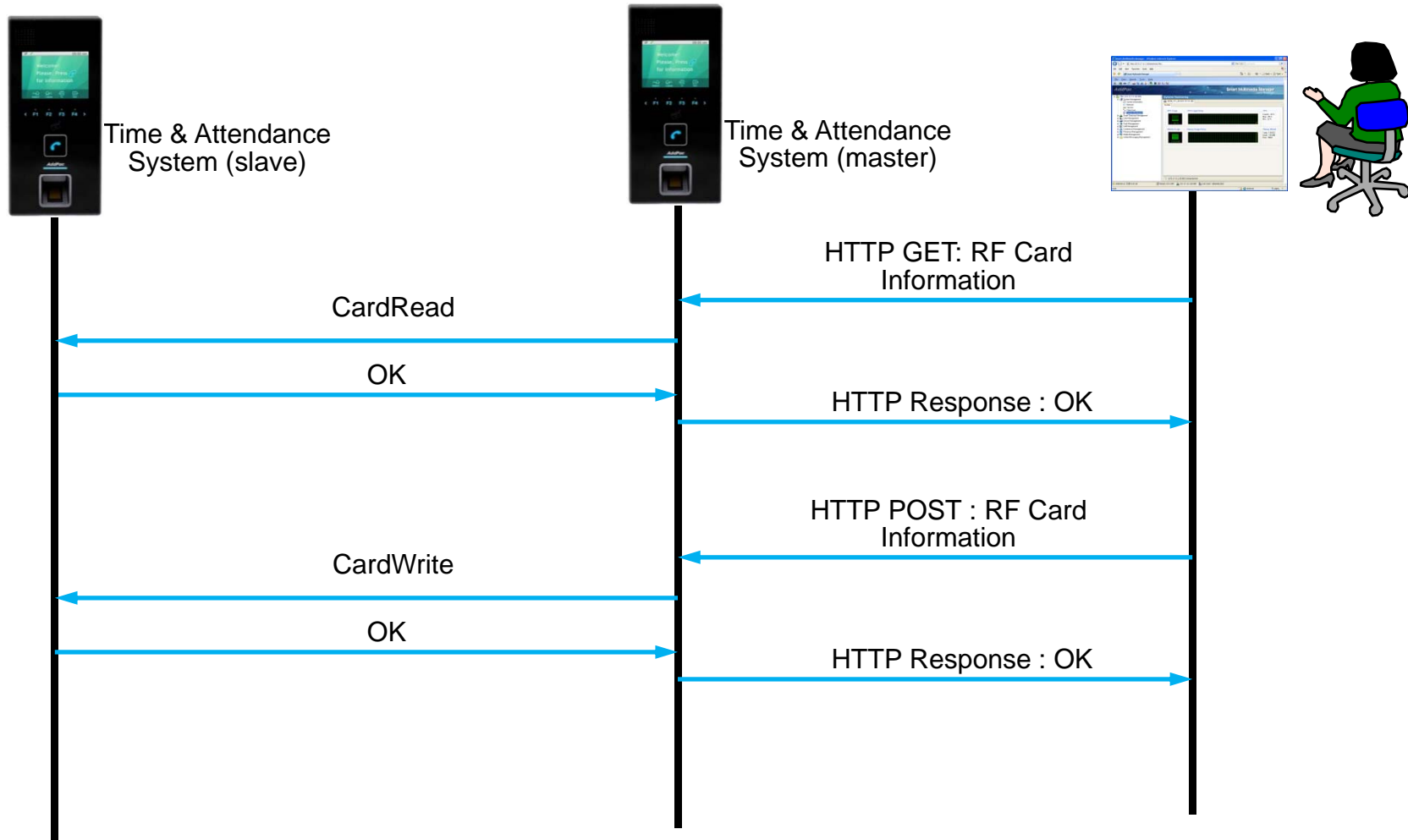

Time & Attendance System Message Flow

Door Open by RF Card

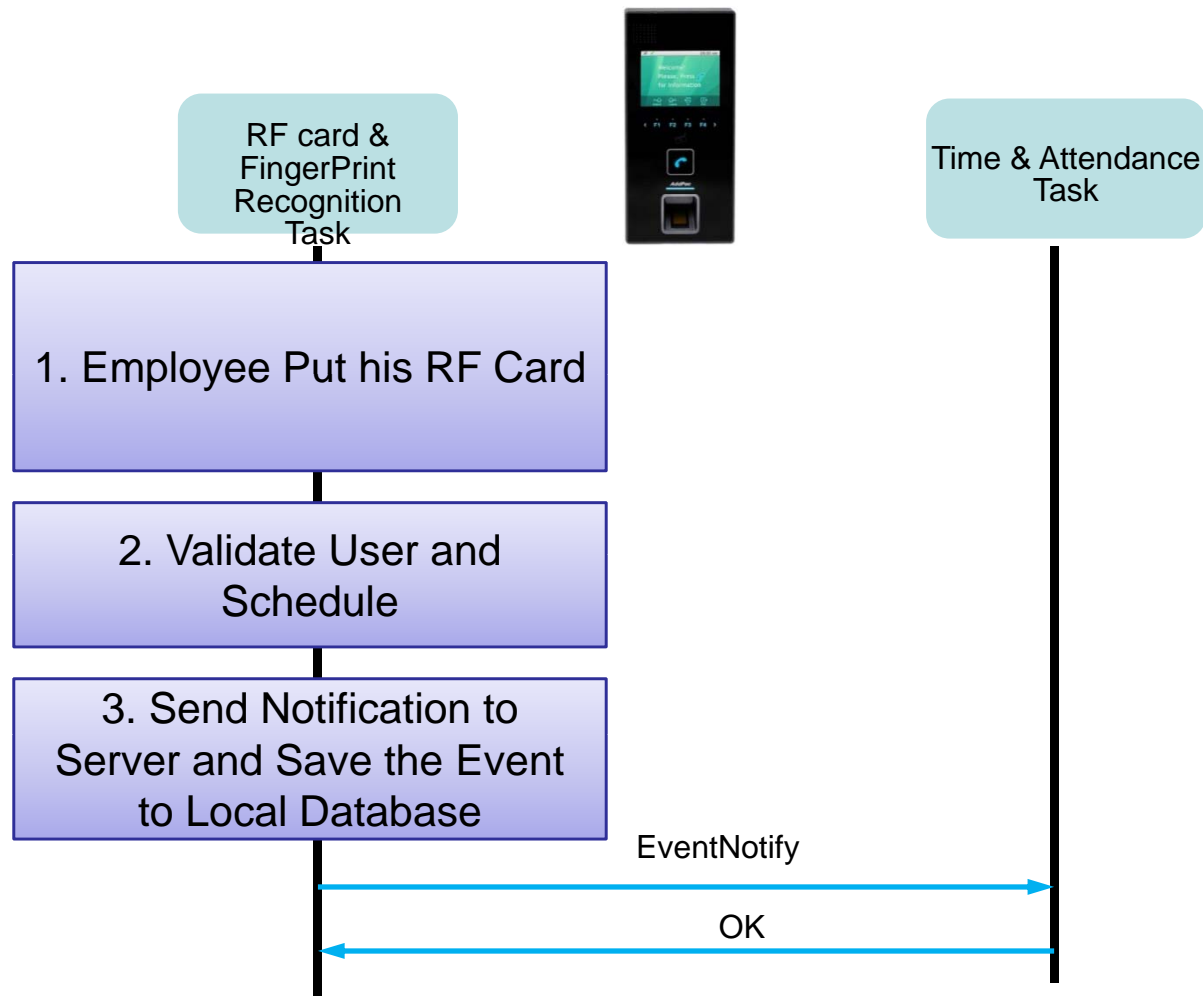

Time & Attendance System Message Flow

Door Open by Other Terminal

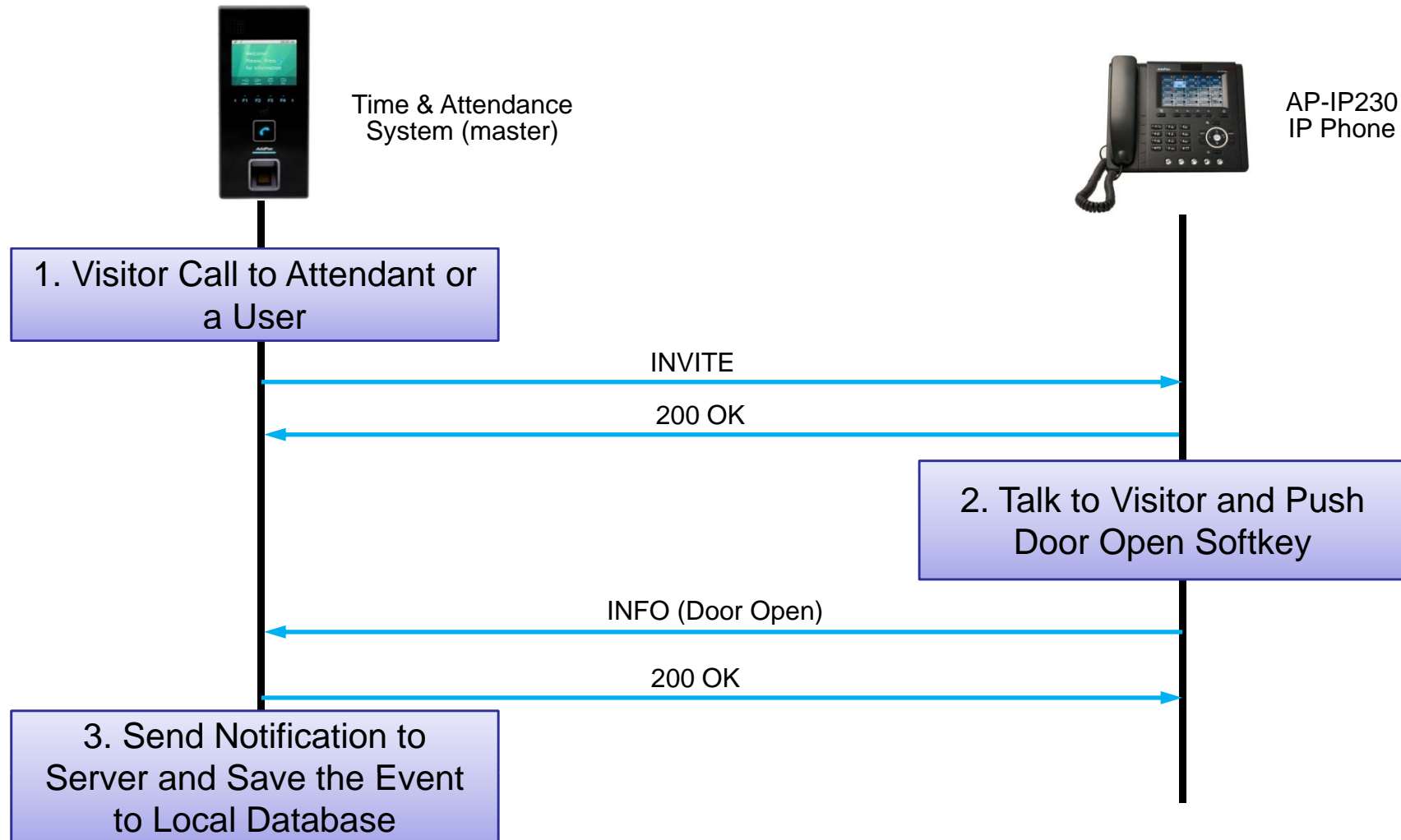



Door Access Control Manager for AP-TAS300

DACS (Door Access Control System)

Login page

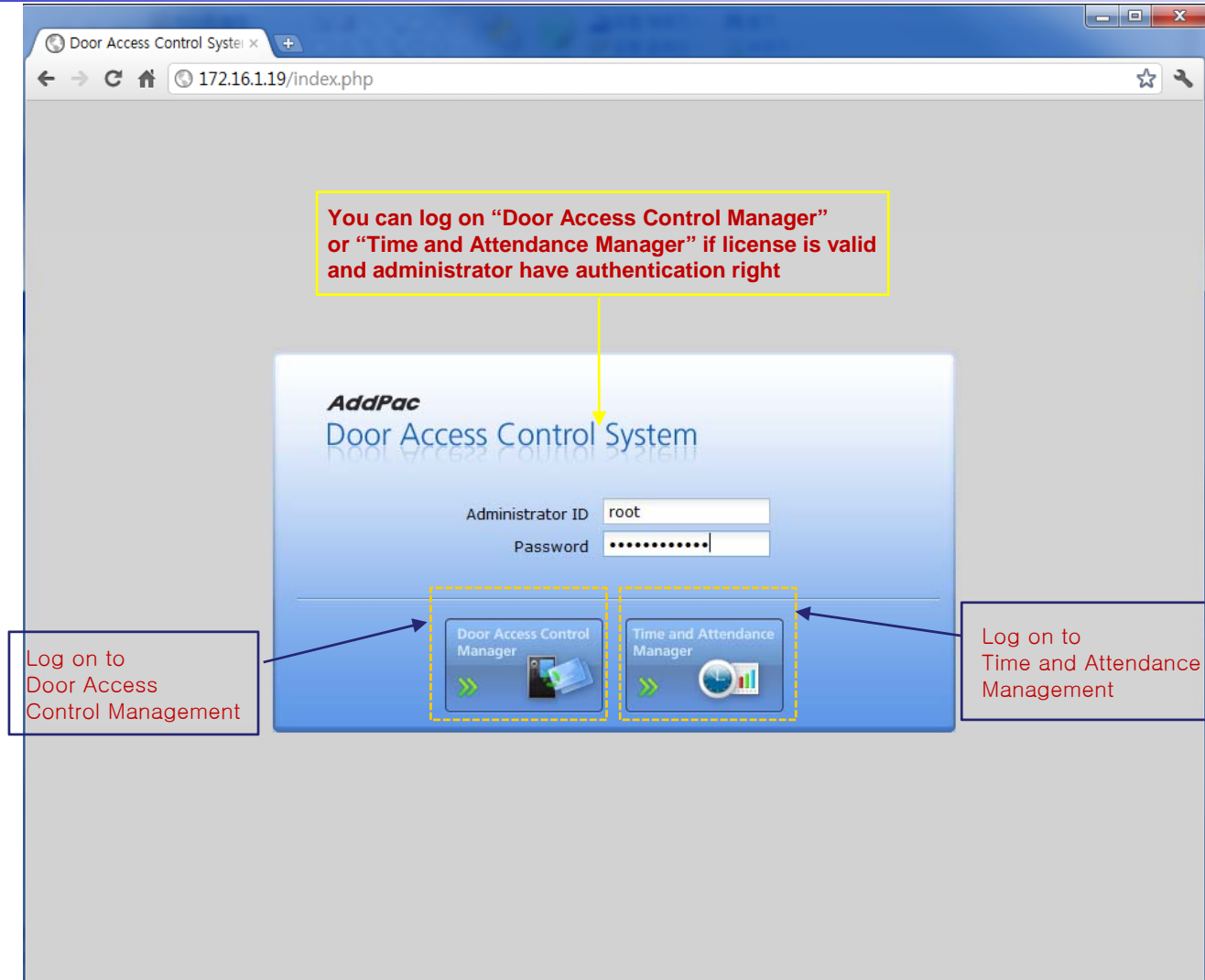

TAAM (Time and Attendance Manager)

Daily Attendance Rules

The image displays two overlapping screenshots of the 'Time and Attendance Manager' web application. The background screenshot shows the 'Daily Attendance Rule List' page, which contains a table of existing rules. A yellow dashed box highlights the 'In', 'Out', and 'Regular Hour' columns for the first three rules. A yellow callout box points to these columns with the text: 'shows In (office-in time), Out (office-out time) and Regular working time, for example 9 hours'. The foreground screenshot shows the 'Add Daily Attendance Rule' form. A yellow callout box points to the 'Daily Attendance Rule' section of the form with the text: 'This day rule can be used in the monthly rule for sunday through saturday each.' The form includes fields for Rule Name, Description, Day Start Time, In, Out, and Regular Hour, along with sections for allowable time and overtime.

Name	Description	In	Out	Regular Hour	Date Created
1 default rule	default daily rule	09:00	18:00	9 hr	
2 Factory First Rule	Factory first daily work rule	08:00	20:00	12 hr	2011-11-07 14:32:2
3 Factory Second Rule	Factory second daily work r...	20:00	08:00	9 hr	2011-11-07 14:33:1

shows In (office-in time), Out (office-out time) and Regular working time, for example 9 hours

This day rule can be used in the monthly rule for sunday through saturday each.

TAAM (Time and Attendance Manager) Monthly Attendance Rules

Door Access Control System

Home User and Terminal Access Control Card Time and Attendance Log and Report

Monthly Attendance Rule

1. Monthly Rule
Defines day off or work day from starting first week to sixth week of the month. Each day of the week can be applied to daily-based attendance rule.

Rule Name*

Description

1st week: Sun Mon Tue Wed Thu Fri Sat

2nd week: Sun Mon Tue Wed Thu Fri Sat

3rd week: Sun Mon Tue Wed Thu Fri Sat

4th week: Sun Mon Tue Wed Thu Fri Sat

5th week: Sun Mon Tue Wed Thu Fri Sat

6th week: Sun Mon Tue Wed Thu Fri Sat

*Clicked: Full Day Off *Non-Clicked: Work Day

Sunday: N/A
Monday: N/A
Tuesday: N/A
Wednesday: N/A
Thursday: N/A
Friday: N/A
Saturday: N/A

2. Holiday Rule
Defines rule for non-working day such as national holiday, user defined holiday in the day template.

Day Template List	
Name	Description
public holiday	public holiday description
company holiday	company holiday description

List of applied Day Templates	
Name	Description

Day of week rule from 1st week to 6th week and grey color means full day off, other color is work day

You can specify daily rule from the list for sunday through saturday

AddPac Copyright © AddPac 1999-2011 All Rights Reserved

TAAM (Time and Attendance Manager)

Business Trip and Vacation

The screenshot shows the 'Business Trip and Vacation' section of the TAAM application. It features a table with two entries and three callout boxes explaining specific details.

Name	Description	User	Type	Start	End	Date Created	Modify	Delete
1 Rusia Business...	Presentation for Ne...	Total 2 includin...	Business trip	2011-09...	2011-10...			
2 Summer Vacati...			Vacation	2011-08...	2011-08...	2011-10-12 07:...		

Annotations:

- one or more user can be specified for each business trip and vacation rule.
- Extension user will be not processed as absentee between start day and end day, also log as user-defined time attendance code
- user-defined time and attendance code for attendance report or log correction

TAAM (Time and Attendance Manager)

Time and Attendance Codes

Door Access Control System x
172.16.1.19/dacm/timeAttendanceCodeList

Time and Attendance Manager
Mon Nov 7 14:44:06 2011
Help | Logout
root

Home Policy Trip and Vacation Report Configuration Report View

Time and Attendance Codes
Shows list of user defined attendance code which can be used as correction in the attendance report.

Add a Code

Name	Description	Date Created	Modify	Delete
1 Unknown				
2 Not yet defined				
3 Late In				
4 Early Out				
5 Absence				
6 Late In/Early Out				
7 Normal				
8 Vacation				
9 Business trip				
10 Sick Leave	Sick Leave code by admin	2011-11-07 14:44:15		

system built-in time and attendance code is provided as default, for example late-in, early-out and absence

show built-in and user-defined time and attendance code which will be used in the attendance report and log correction

only user-define code can be removed if needed

AddPac Copyright © AddPac 1999-2011 All Rights Reserved Version 1.1.14

TAAM (Time and Attendance Manager) Delivery Policy for Attendance Report

1. Report Policy
Defines email delivery policy for manager or each user to receive daily, monthly attendance report.

Send reports to the particular person every day at 08:00

Send reports to the particular person at specific day (28) of every month.

User List

Name	Department	Extension
------	------------	-----------

Applied user list

Name	Department	Extension
batista Eike	/2F/	1000
Stefan Persson	/2F/	1016

Send personal monthly report to each user.

2. SMTP Server
You can specify sending email server(SMTP) configurations.

SMTP Server: 61.33.161.2

Sender Email Address: dacs_admin@company.com

Server Authentication Required

User ID: admin

Password: ****

To apply this features, select 'Apply' or 'Cancel'

Apply Cancel

AddPac Copyright © AddPac 1999-2011 All Rights Reserved Version 1.1.14

manager level users (extension) list who want to receive daily and monthly attendance report

if checked, system will send personal attendance report of each month to extension user

TAAM (Time and Attendance Manager)

Attendance Report by Date

Time and Attendance Manager

Mon Nov 7 14:52:05 2011 Help | Logout root

Home Policy Trip and Vacation Report Configuration Report View

Attendance Report by Date
Shows attendance log for each user and summary information with specified day.

Select Date : 2011-10-19

Select Department : All

Attendance Report by Date (2011-10-19)

Username	Department	In	Out	Overtime	Office Hc	Result	Correction Ti	Correct
1 Eike batista	smart management팀	08:05:00	18:05:00	0 hr	10:0...	Normal		
2 Bill Gates	multimedia팀	09:15:00	17:15:00	0 hr	08:0...	Normal	2011-11-...	
3 Larry Ellison	multimedia팀	09:00:00	18:00:00	0 hr	09:0...	Normal		
4 karl Albrecht	smart framework팀	09:00:00	17:00:00	0 hr	08:0...	Early Out		
5 Carlos Slim Helu	smart management팀	09:10:00	19:10:00	0 hr	10:0...	Normal		
6 Lakshmi Mittal	multimedia팀	09:00:00	18:00:00	4 hr	09:0...	Normal		
7 Christy Walton	smart framework팀	09:00:00	18:00:00	0 hr	09:0...	Normal		

You can export to excel or print out for attendance report

attendance summary for each time and attendance code with specified date

administrator may adjust or correct attendance log which system have processed if necessary

TAAM (Time and Attendance Manager) Attendance Report Excel Export

Attendance Report by Date (2011-10-19)							
Username	Department	In	Out	Overtime	Office Hours	Result	Correction Time
Eike batista	smart management	08:05:00	18:05:00	0 hr	10:00:00	Normal	
Bill Gates	multimedia	09:15:00	17:15:00	0 hr	08:00:00	Normal	2011-11-07 14:52:28
Larry Ellison	multimedia	09:00:00	18:00:00	0 hr	09:00:00	Normal	
karl Albrecht	smart framework	09:00:00	17:00:00	0 hr	08:00:00	Early Out	
Carlos Slim Helu	smart management	09:10:00	19:10:00	0 hr	10:00:00	Normal	
Lakshmi Mittal	multimedia	09:00:00	18:00:00	4 hr	09:00:00	Normal	
Christy Walton	smart framework	09:00:00	18:00:00	0 hr	09:00:00	Normal	
Lika Shing	smart framework	09:20:00	18:20:00	0 hr	09:00:00	Late In	
Stefan Persson	smart framework	09:00:00	20:00:00	2 hr	11:00:00	Normal	
Warren Buffett	multimedia	09:15:00	18:15:00	0 hr	09:00:00	Normal	
Amancio Ortega	smart management	09:00:00	21:00:00	3 hr	12:00:00	Normal	
Mukesh Ambani	smart management	09:00:00	18:30:00	0 hr	09:30:00	Normal	

TAAM (Time and Attendance Manager)

Attendance Report by Month



attendance summary for each time and attendance code with specified month

attendance summary for each extension user

TAAM (Time and Attendance Manager)

Attendance Daily Report by Month

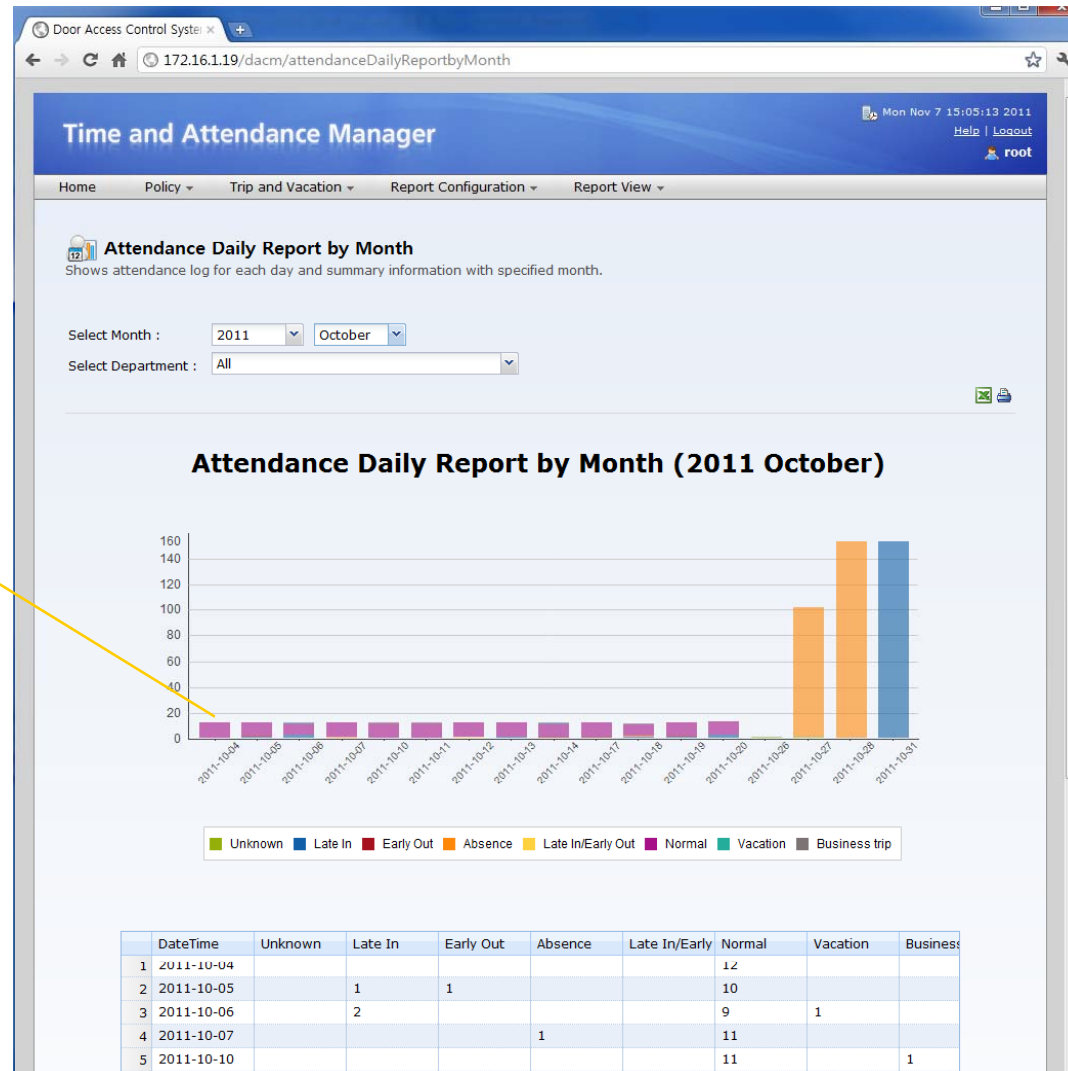

clustered column of attendance summary with time span from first to end of the month

TAAM (Time and Attendance Manager) Attendance Personal Report

Attendance Personal Report (2011 October)
Carlos slim Helu (/2F/)

Type

Type	Count
Late In	1
Early Out	2
Absence	1
Normal	10
Business trip	1

	DateTime	In	Out	Overtime	Office Hours	Result
1	2011-10-04	09:00:00	18:00:00	0 hr	10:00:00	Normal
2	2011-10-05	09:00:00	18:00:00	0 hr	10:00:00	Normal
3	2011-10-06	09:00:00	18:00:00	0 hr	10:00:00	Normal
4	2011-10-07	09:00:00	18:00:00	0 hr	10:00:00	Normal
5	2011-10-10	09:10:00	19:10:00	0 hr	10:00:00	Normal
6	2011-10-11	09:10:00	19:10:00	0 hr	10:00:00	Normal
7	2011-10-12	09:10:00	19:10:00	0 hr	10:00:00	Normal
8	2011-10-13	09:10:00	19:10:00	0 hr	10:00:00	Normal
9	2011-10-14	09:10:00	17:10:00	0 hr	08:00:00	Early Out

attendance summary for time and attendance code of a extension user

You can specify one extension user for attendance report of the month



Open API

Open API

Open API for 3'rd Party Management System

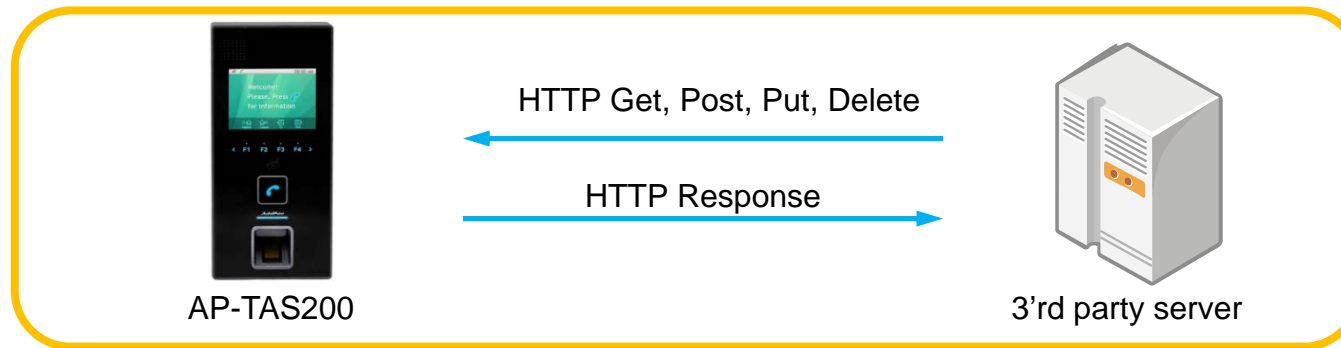

- HTTP based RESTful Open API for Door Access Management
- XML based Flexible and Expandable Message Contents
- Provides More than 40 APIs as Bellow
 - user_list(GET), user(GET, POST, PUT, DELETE), ...
 - terminal_list(GET), terminal(GET, POST, PUT, DELETE), ...
 - access_group(GET, POST, PUT, DELETE), priority (PUT), ...
 - card_list(GET), card(POST, PUT, DELETE), ...
 - schedule_template(GET, POST, PUT, DELETE), rule(GET, POST, PUT, DELETE), ...

Application Area

- Point-to-Point Application (Simple Application)
- Point-to-Multipoint Application



Point-to-Point Connection (Simple Appl.)

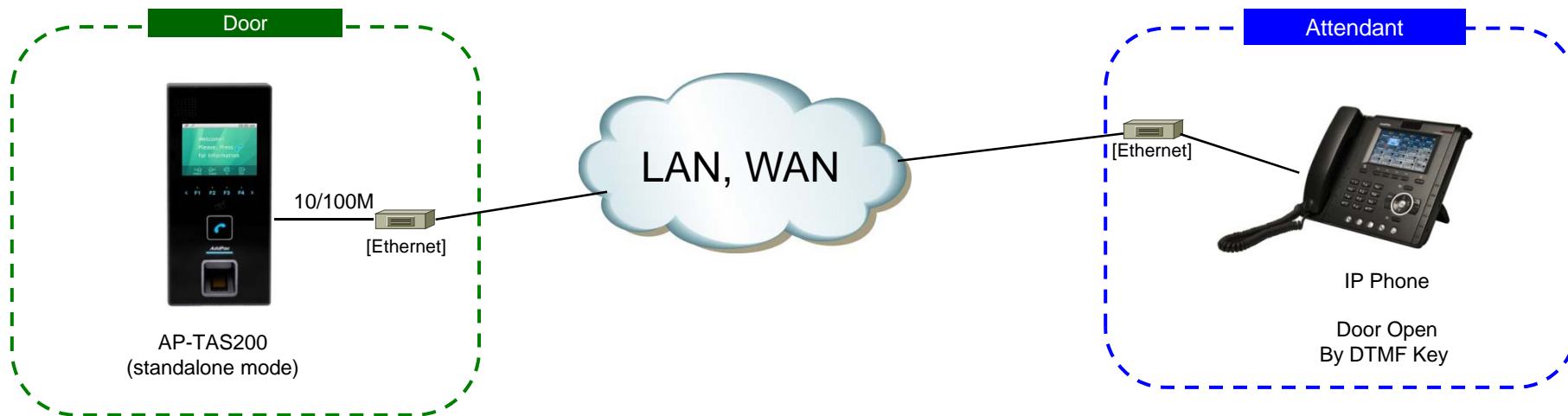

Smart Web Manager



DACM (Door Access Control Manager) for Access Management (master mode)

Integrated Door Access Control and Call Control

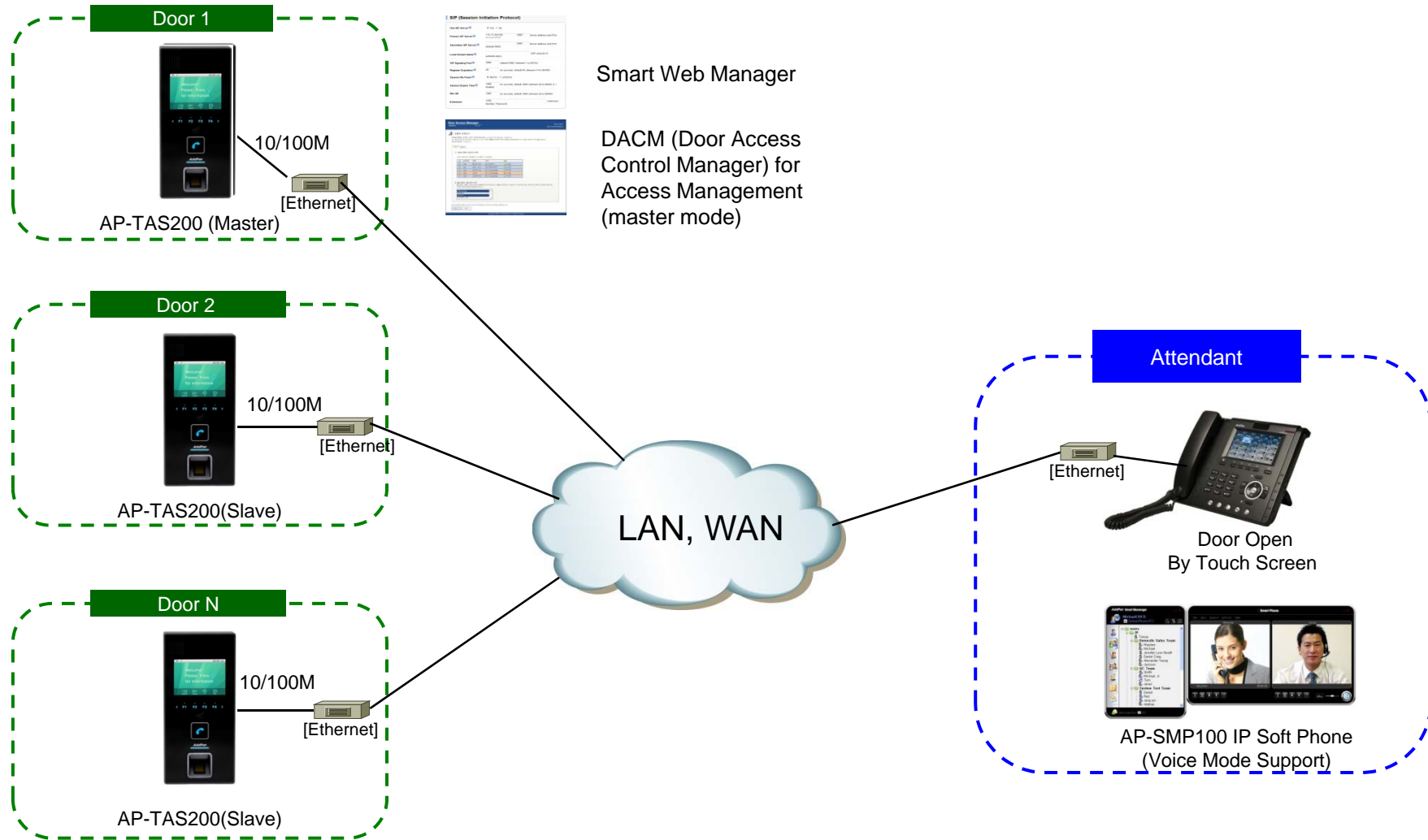

Ordering Information

- **AP-TAS200 Time & Attendance IP Voice Door Phone Hardware**
 - AP-TAS200 Main Body
 - RISC Microprocessor with High-end Programmable DSP Architecture
 - 3.5 Inch LCD Display
 - Fingerprint Recognition, RF card Interface
 - Steel Chassis
 - Internal MIC, Internal Speaker
 - 1-ports 10/100Mbps Fast Ethernet
 - PoE Interface
 - Including Network Cable Set & Ext. Power Supply, etc.
- **Built-in APOS Internetworking Software for AP-TAS200**
- **Including 1 Year Hardware Warranty**
- **Product Documents**
 - Install and Operation Guide (PDF)
- **Pricing**
 - AddPac Technology Regional Sales Manager
 - Authorized Sales and Marketing Representatives
 - Please Contact www.addpac.com



Thank you!

AddPac Technology Co., Ltd.
Sales and Marketing

Phone +82.2.568.3848 (KOREA)

FAX +82.2.568.3847 (KOREA)

E-mail sales@addpac.com