



AP-GV3100N

32-Port GSM VoIP Gateway

High Performance 32-Port GSM VoIP Gateway Solution



AddPac

AddPac Technology

Sales and Marketing

www.addpac.com

Contents

- Product Overview
- Hardware Specification
- APOS Technology
- VoIP (Voice over IP) service
- Advanced QoS Features
- Network Protocols
- Network Management
- Smart Web Management
- Security Management
- Application Service
- Ordering Information



Product Overview

AP-GV3100N 32-Port GSM VoIP Gateway

- Four(4) Module Slots for 8-Port GSM Module(Up to 32-Port GSM)
- Hot-Swap Function Support
- H.323/SIP Dual Concurrent Stack Embedded
- High Performance RISC & Programmable DSP Architecture
- G.711/G.726/G.723/G.729, T.38 Fax , VAD, etc
- Powerful Network Protocols (PPPoE, DHCP, Static Routing, etc)
- Two(2)10/100Mbps Fast Ethernet
- One(1) RS-232C Port for Command Line Interface
- Firmware Upgradeable Architecture
- Smart Web Manager Support
- Smart NMS(Network Management System) Support
- Advanced Voice QoS Mechanism
- Rack Mountable Chassis with Internal Power Supply

Product Highlights

AP-GV3100N 32-Port GSM VoIP Gateway

Powerful GSM Gateway

State-of-art Signaling
H.323, SIP
Concurrent Dual Stack

Rack Mountable Chassis

Four(4) Module Slot,
8-Port GSM Module

High Performance RISC CPU
+ Programmable DSP

Excellent Voice Quality
G.729/G.723/G726/G711

Broadband IP Networking
With Two(2) 10/100Mbps
Fast Ethernet

APOS™ Technology
Firmware Upgradeable Architecture

Smart Web Manager
Smart NMS Support

Powerful Network Protocol
Support

Powerful Trouble Shooting &
Debugging Feature Support

Advanced Voice
Traffic QoS Mechanism

AddPac

www.addpac.com

APOS Technology

AP-GV3100N 32-Port GSM VoIP Gateway

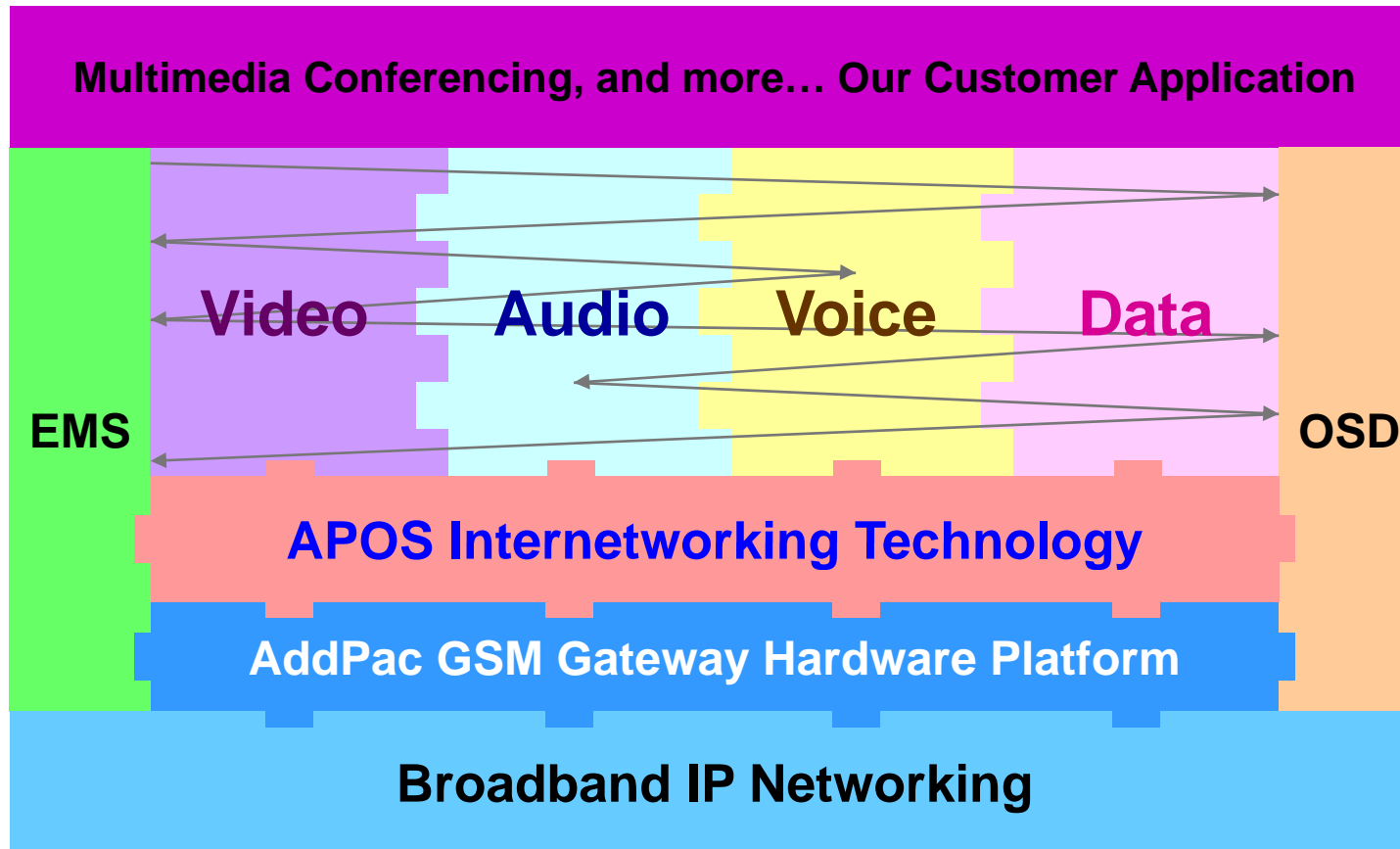

- APOS : AddPac Internetworking Operating System
- OSD : On- Screen Display
- EMS : Element Management System

Hardware Specification

AP-GV3100N 32-Port GSM VoIP Gateway

RISC
CPU

High-end
DSP

- RISC Microprocessor Computing Power
- Four(4) Module Slots for GSM VoIP Interface
- 8-Port GSM Modules (AP-N5-GSM8I, AP-N5-GSM8SI, AP-N5-GSM8UI)
 - 8-Port Front SIM Card Slots
 - 8-Port Antenna Interface
 - Hot-Swap
- Network Interface
 - Two(2) 10/100Mbps Fast Ethernet (RJ45)
- RS232C Console Interface for CLI
- Run LED, LAN LED, Port LEDs
- Internal Power Supply



Hardware Specification

AP-GV3100N 32-Port GSM VoIP Gateway

RISC
CPU

High-end
DSP

AP-GV3100N GSM VoIP Gateway	Basic Specifications
Voice Interface	Four(4) Module Slots for GSM VoIP Interface
	AP-N5-GSM8I, AP-N5-GSM8SI, AP-N5-GSM8UI
Ethernet Interface	2-Ports 10/100Mbps Ethernet Interface(RJ-45)
Flash Memory	512Mbyte NAND Flash Memory
Base Memory	128Mbyte High-speed DDR2
Power Requirement	Power Supply / VAC 110~220V, 50/60Hz, 5V 20A
Operating Temperature	0°C ~ 45°C (32 °F ~ 122°F)
Storage Temperature	-40°C ~ 85°C (-40°C ~ 185°F)
Relative Humidity	5% ~ 95% (Non-condensing)
Dimension (H x W x D)	56mm x 440mm x 313mm
Weight(kg)	5.2Kg

Hardware Specification

AP-GV3100N 32-Port GSM VoIP Gateway

RISC
CPU

High-end
DSP

Front Side View

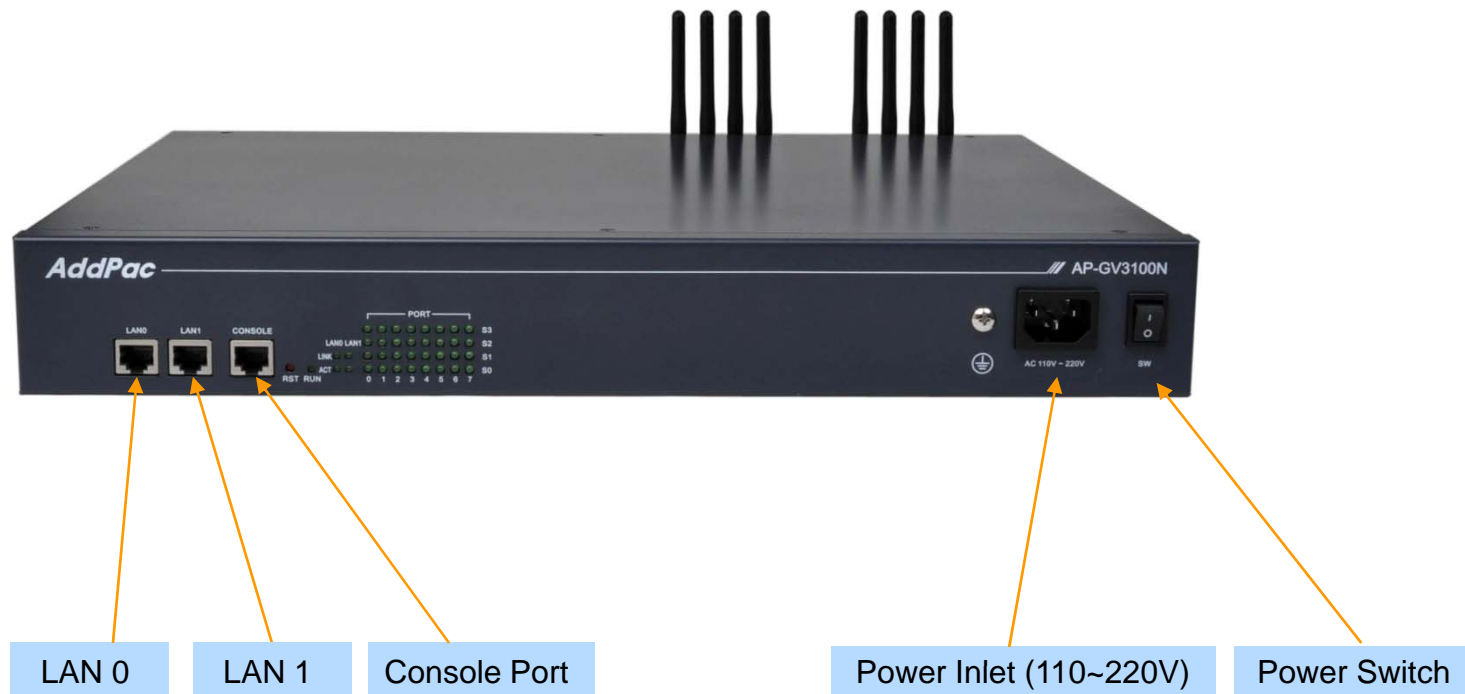

Hardware Specification

AP-GV3100 Multi-Port GSM VoIP Gateway

RISC
CPU

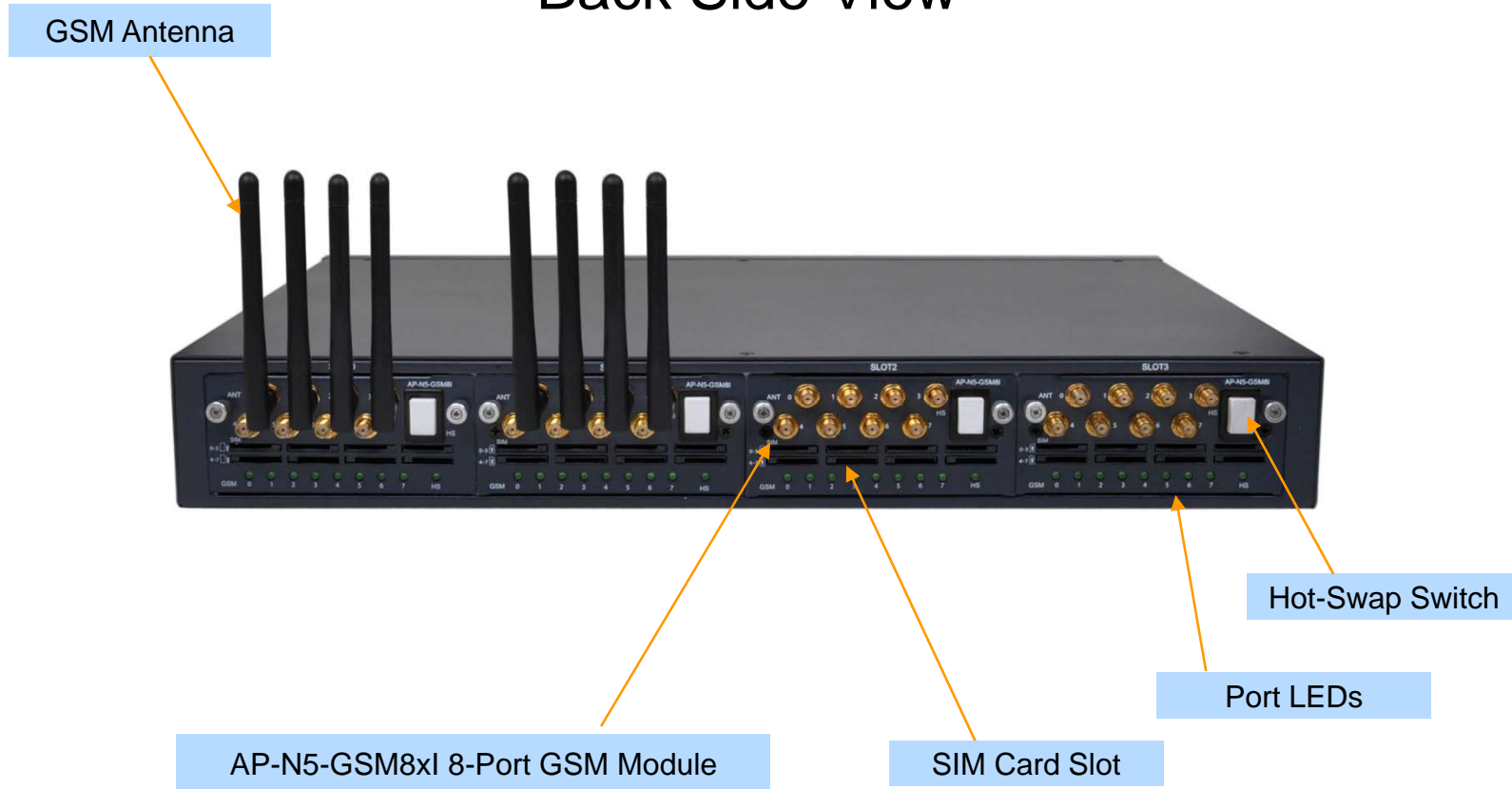

High-end
DSP

Back Side View



GSM VoIP Modules

AP-GV3100N 32-Port GSM VoIP Gateway

Model	AP-N5-GSM8I	AP-N5-GSM8SI	AP-N5-GSM8UI
			
Available Target	AP-GV3200 AP-GV3100 AP-GV2000 AP-GS1016	AP-GV3200 AP-GV3100 AP-GV2000 AP-GS1016	AP-GV3200 AP-GV3100 AP-GV2000 AP-GS1016
GSM Channel	8-Port	8-Port	8-Port
IMEI change	Support : Multiple Change	Support : Multiple Change	Support : One Time Change
Frequency Band	Quad-Band	Dual-Band (900MHz, 1800MHz)	Quad-Band
External Antenna	8	8	8
Hot-Swap	Support	Support	Support
VoIP Codec	G.711, G.729, G.723.1,etc	G.711, G.729, G.723.1,etc	G.711, G.729, G.723.1,etc

Hardware Specification

AP-GV3100N 32-Port GSM VoIP Gateway

RISC
CPU

High-end
DSP

SIM Card Slot



AP-N5-GSM8xI
(8-Port GSM Module)

GSM Antenna
Internal 4Ch Combiner

Hot-Swap Switch

Port LEDs

Hardware Specification

AP-GV3100N 32-Port GSM VoIP Gateway

RISC
CPU

High-end
DSP

GSM Gateway Service Diagram

8-Port GSM Module Internal H/W Block Diagram

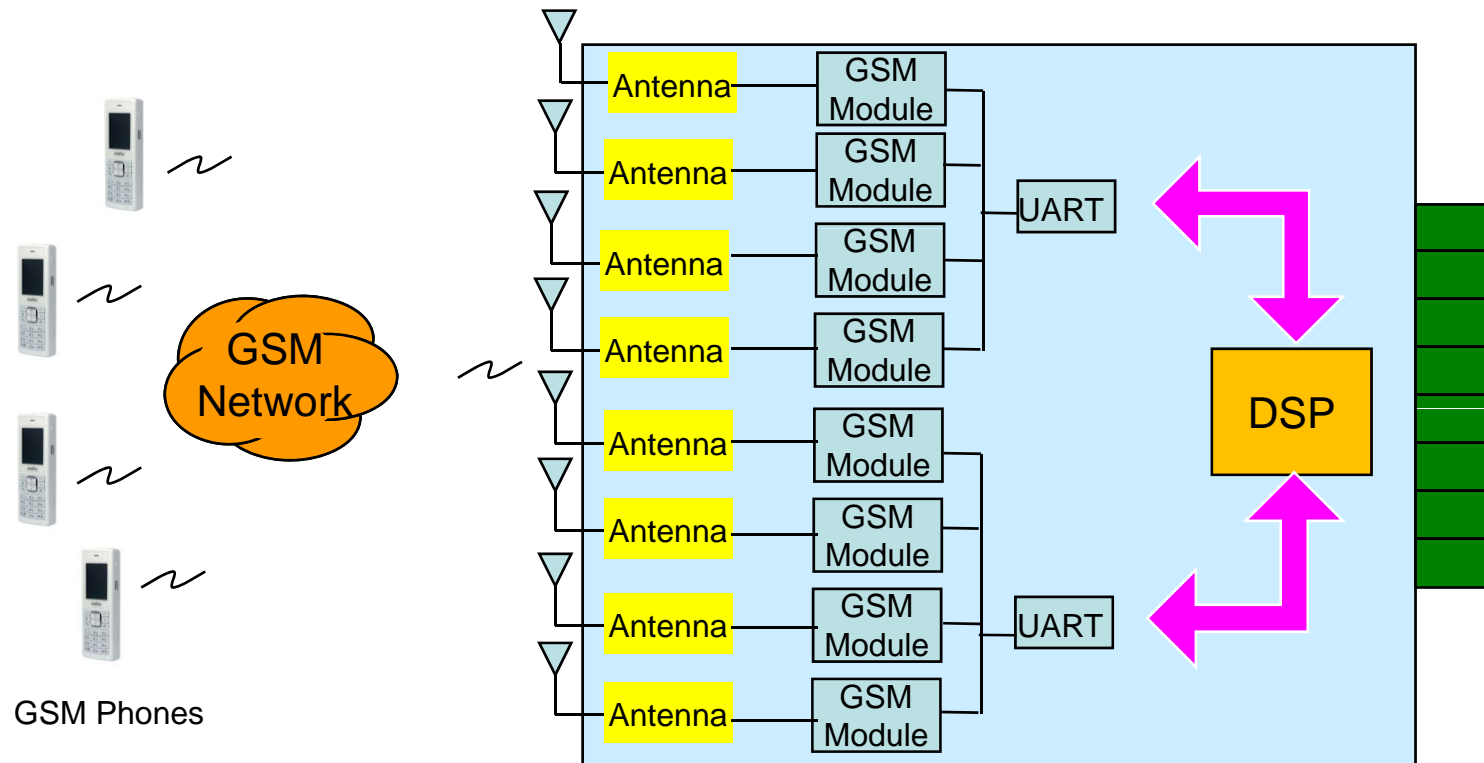

Hardware Specification

AP-GV3100N 32-Port GSM VoIP Gateway

RISC
CPU

High-end
DSP

GSM VoIP Gateway Service Diagram

32-Port GSM VoIP Gateway Service Diagram (8-Port x 4 Module)

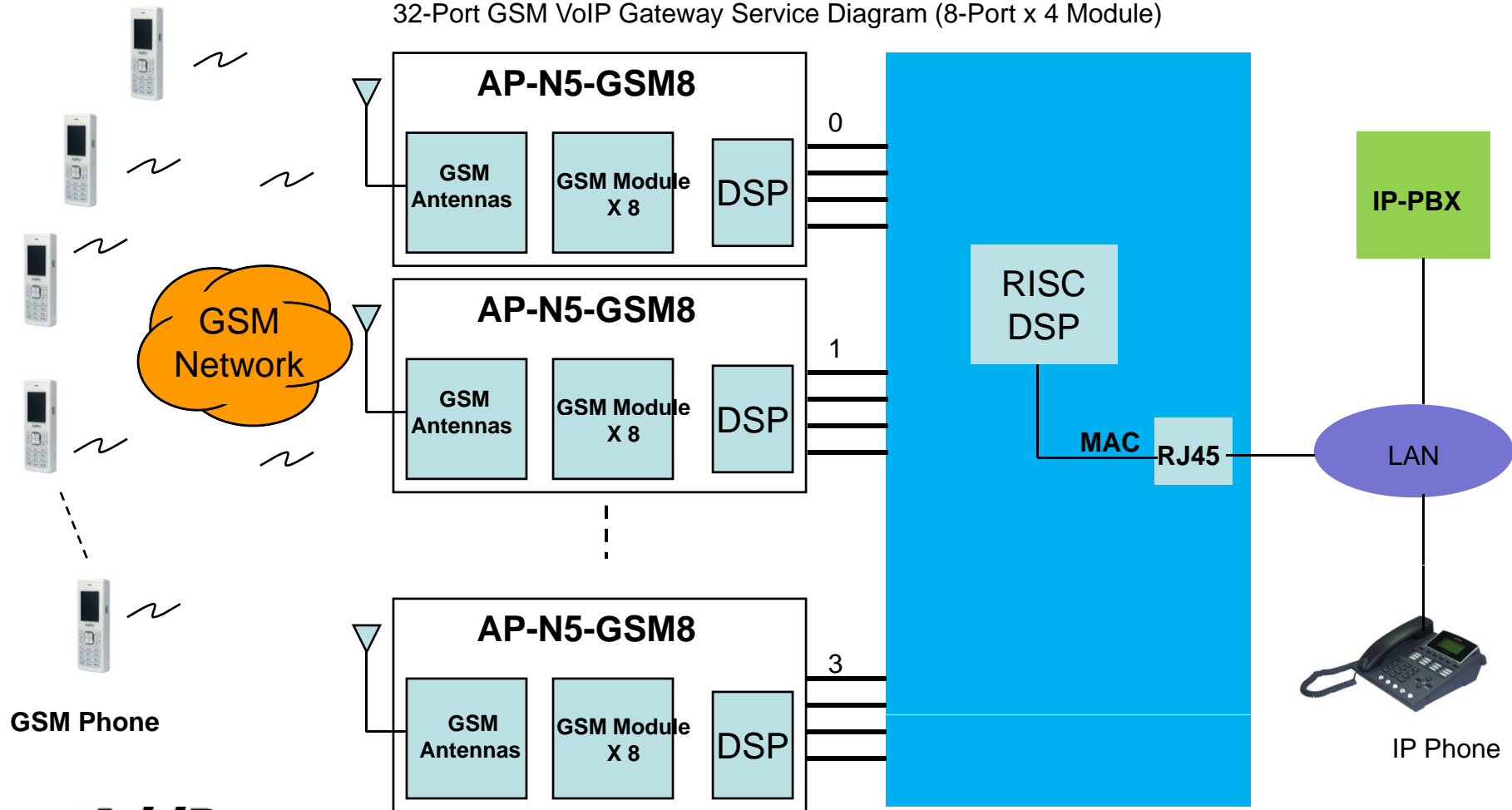

GSM Phone

AddPac

www.addpac.com

IP Phone

VoIP (Voice over IP) Service

AP-GV3100N 32-Port GSM VoIP Gateway

- H.323, SIP Dual Stack
- H.323
 - ITU-T Standard H.323 v3 Support
 - Support H.245 Tunneling
 - Including H.235 Security Features
- SIP
 - IETF RFC3261 or RFC2543 SIP Standard

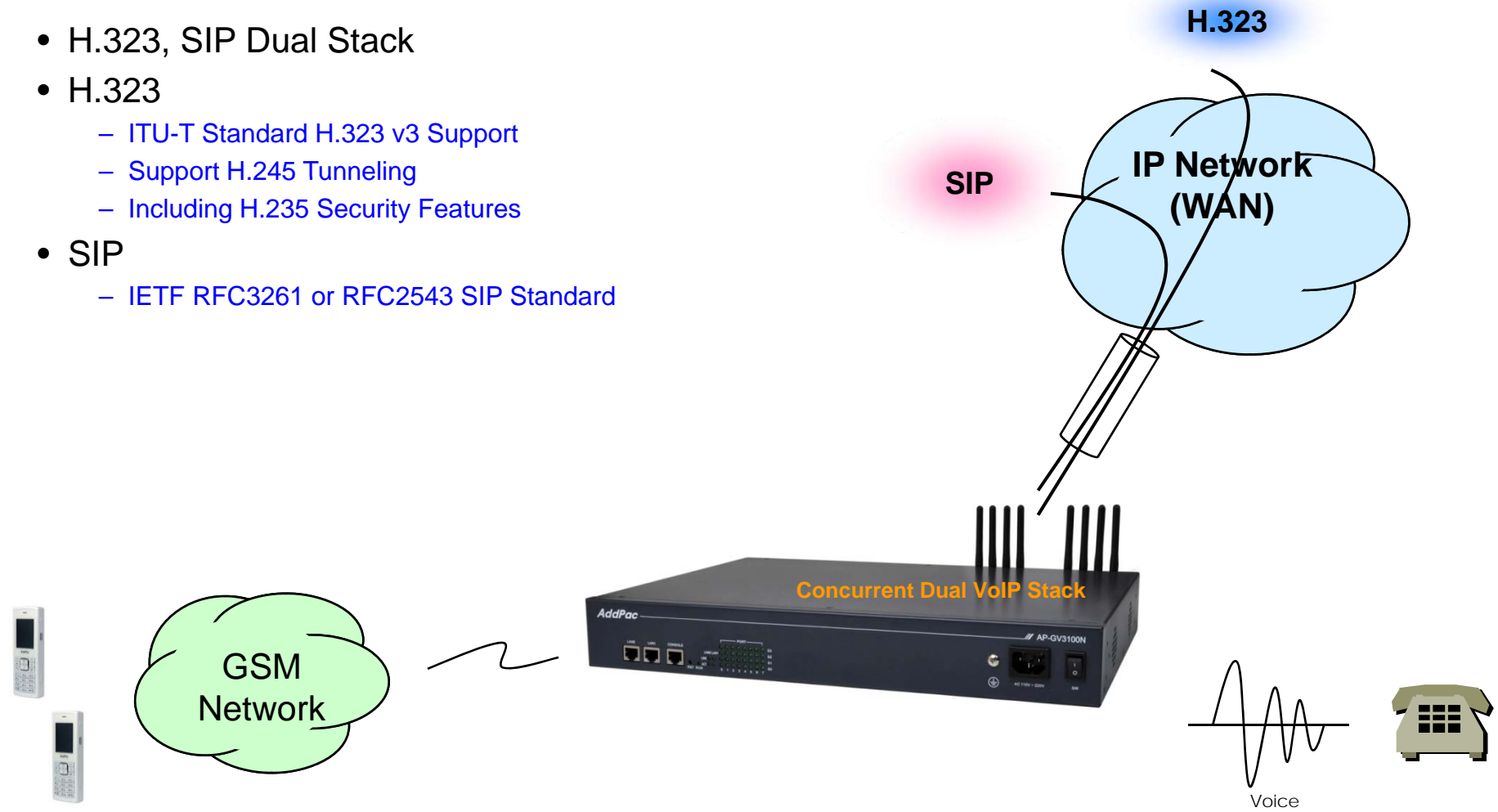

VoIP (Voice over IP) Service

AP-GV3100N 32-Port GSM VoIP Gateway

- H.323

- Fast connect, normal connect support
- H.245 tunneling support
- Q.931 response message setting for inbound VoIP calls
- H.245 logical channel open timing selection function
- Start H.245 procedure support
- DTMF / Hook flash relay with H.245 alphanumeric / signal
- Secondary gatekeeper support
- Gatekeeper assignment according to the domain name
- Gatekeeper discovery with multicast
- Lightweight RRQ support
- Signaling TCP port assignment
- Resource threshold setting with RAI
- H.235 clear-token, crypto-token support
- canMapAlias support
- Technical prefix (supported prefix) support
- Public IP assignment in NAT environment

- SIP

- Gateway-based / Endpoint-based registration support
- Secondary proxy-server assignment function
- SIP signaling port change function
- SIP proxy server assignment according to the domain name
- T.38 real-time fax relay support
- DTMF relay support with RFC2833 / OPTION message
- Re-INVITE support

VoIP (Voice over IP) Service

AP-GV3100N 32-Port GSM VoIP Gateway

- Voice Codec

- G.711 A-Law, G.711 U-Law
- G.726 r16, G.726 r32
- G.729A
- G.723.1 r63, G.723.1 r53
- VAD (Voice Activity Detection) function support
- DTMF relay support (H.323, SIP, MGCP common) based on RFC2833

- RTP

- Redundant RTP packet transmission in case of severe packet loss
- Dynamic jitter buffer management and RTP packet jitter and loss compensation with heuristic & DSP error concealment
- Static jitter buffer setting support
- Voice frame per RTP packet number control for each codec
- In-band ring-back tone support
- Virtual ring-back tone support
- Tone parameter change support

- FAX

- Fax relay mode supporting T.38, inband-T.38, bypass mode
- Lost packet compensation with redundant setting in case of T.38 fax relay
- Fax relay mode, rate setting for remote end

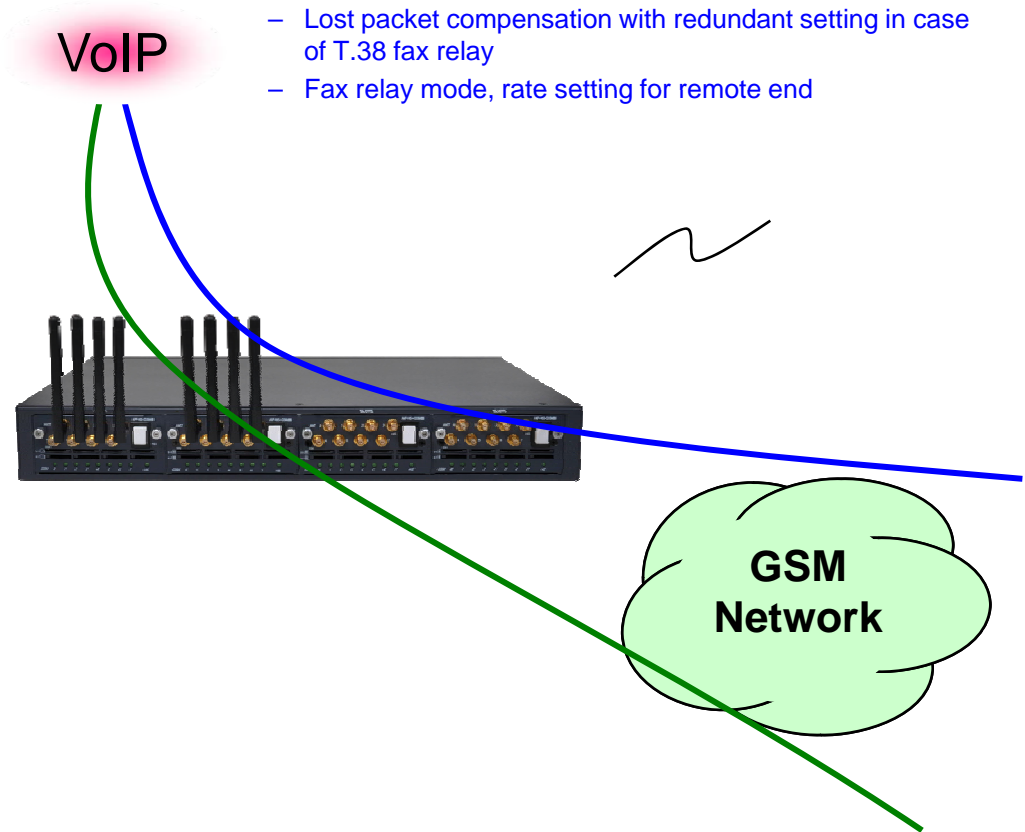

VoIP (Voice over IP) Service

AP-GV3100N 32-Port GSM VoIP Gateway

- VoIP Call Controls

- Hot line connection function with PLAR (Private Line Auto Ring Down)
- Leased line emulation function
- Connection monitoring function
- Fault tolerant with Redundancy and Call Distribution among Gateways for load balancing
- Call attempt with IP address
- H.323, SIP, MGCP inbound call connection for each voice port
- Multiple E.164 setting for one voice port
- One E.164 or digit pattern can be assigned to more than one voice port
- Hunting with Longest match/ priority/ sequence/ random
- One stage call setup by Digit forwarding
- Call barring with specific digit patterns
- Calling and called number conversion for PSTN outbound calls
- PSTN rerouting in case of VoIP call attempt failure

- VoIP Call Controls (cont.)

- Call transfer for internal calls
- Call pickup for internal calls
- Calling and called number conversion for VoIP outbound calls
- Calling and called number conversion for VoIP inbound calls

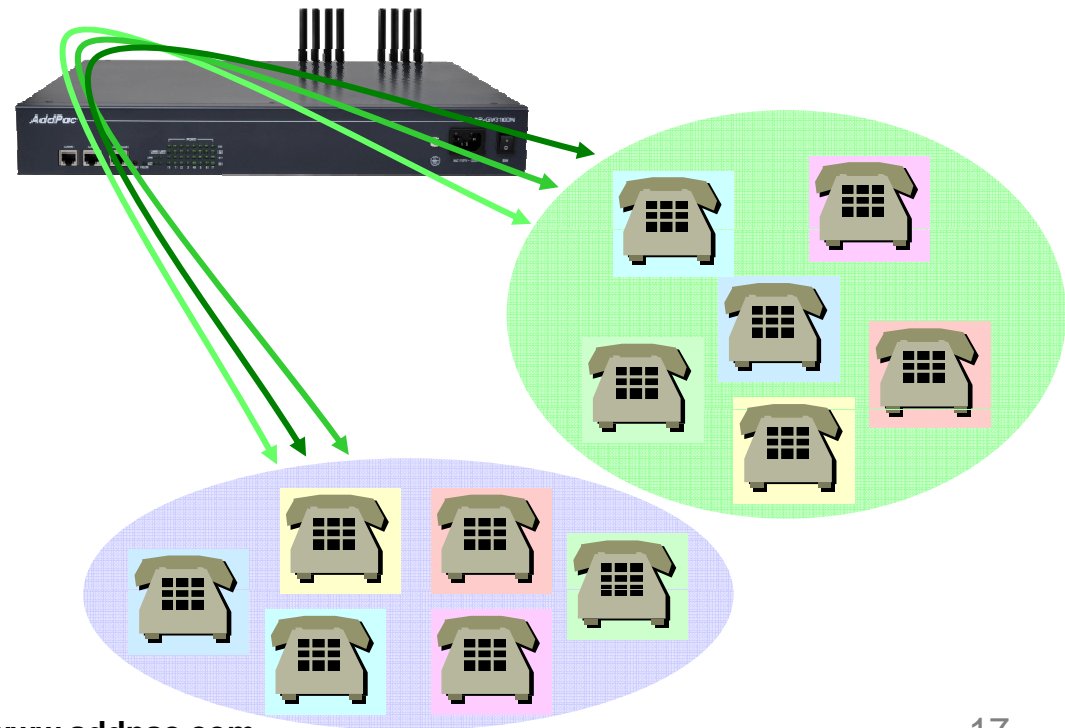

Advanced QoS Features

AP-GV3100N 32-Port GSM VoIP Gateway

- Enhances **Transmit** Voice QoS Features

- Voice Traffic Priority Queuing
- QoS Service Profiling
- Providing Virtual Network Transmit Algorithm
- Real-time Voice Traffic QoS Support
- RTP Packet Transmit Interval Control
- Supporting RTP Packet Redundancy Scheme
- IP Header Control such as ToS, Diffserv

- Enhances **Receive** Voice QoS Features

- Dynamic Jitter Buffer Management
- Error Concealment
- Support T.38 FAX Data Error Recovery Scheme

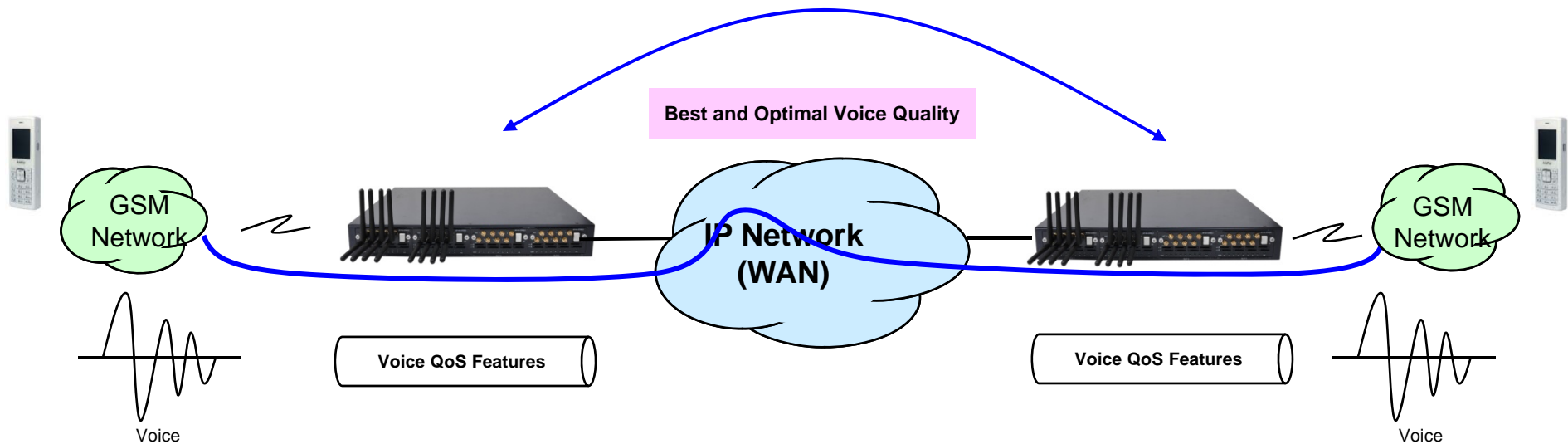

Network Protocols

AP-GV3100N 32-Port GSM VoIP Gateway

Basic Network Protocols

- ARP, IPv4, TCP, UDP, ICMP, SCTP, IGMP, MLD

Routing Protocol

- IPv4 : Static

Service Protocol

- FTP, Telnet, TFTP, DHCP Server/Relay, SNMP Server
- CDP (Cisco Discovery Protocol)
- DNS Resolver , DDNS(nsupdate)
- Bridge
- Syslog

IPv4 Address Configuration

- Fixed (Static)
- DHCP
- PPPoE

Miscellaneous

- Cisco Style CLI
- Standard & Extended IPv4 Access List
- Multi-level User Account Management
- IP accounting
- STUN Client

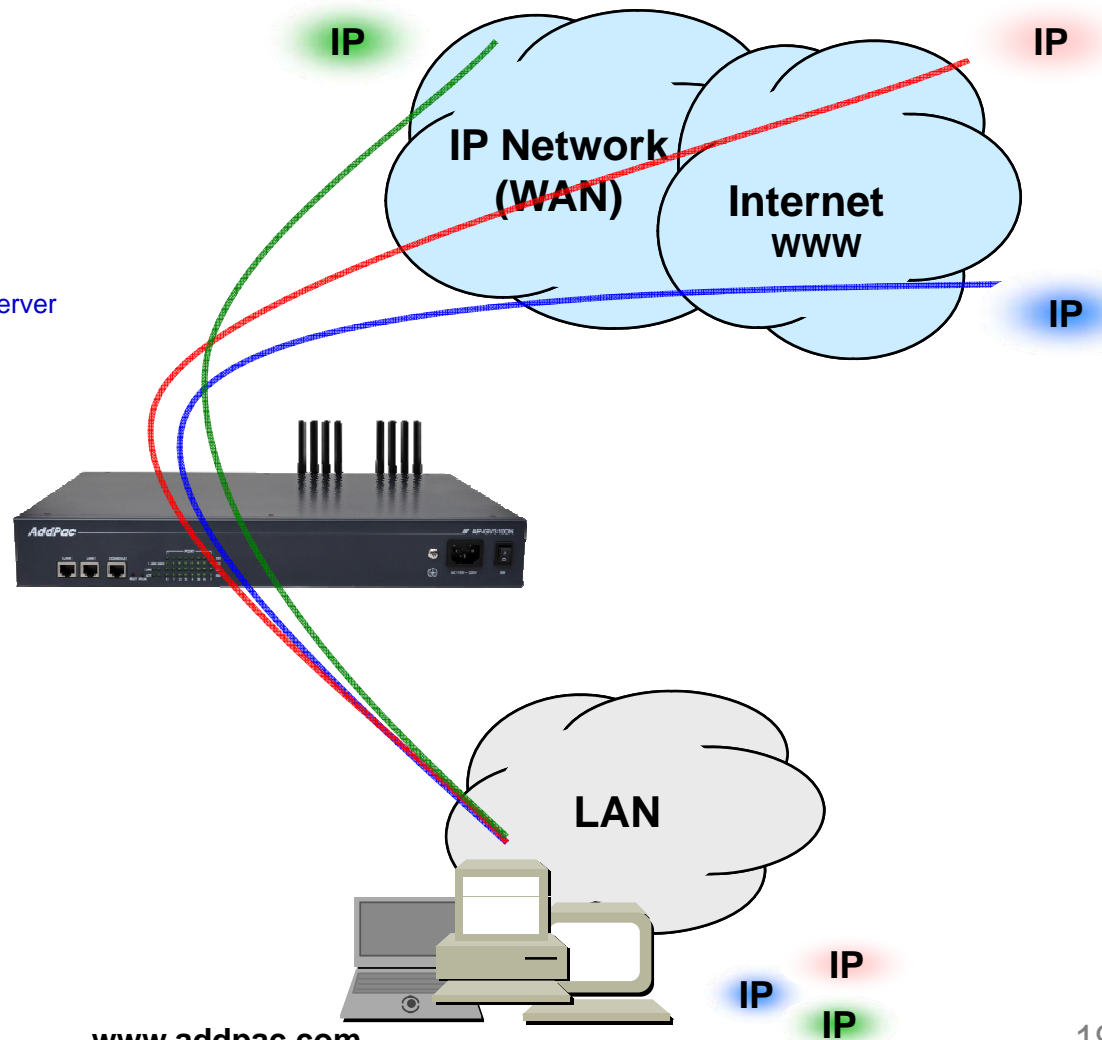

Network Management

AP-GV3100N 32-Port GSM VoIP Gateway

- SNMP
 - Standard Simple Network Management Protocol(SNMP) Agent support
 - MIB v1 and v2 Support
- Web-based Management
 - Smart Easy Setup
 - Standard Voice Interface
 - Standard PSTN Back-up Interface
- Watch-dog Function
 - Hardware, Software watch-dog services
- Remote Management
 - Telnet
 - Rlogin
- Auto Upgrade Service
 - HTTP server based APOS image and configuration file auto-upgrade support
- Batch Job Function
 - Text based script downloading
- Interoperable with Smart NMS Service
 - AddPac Smart Network Management System

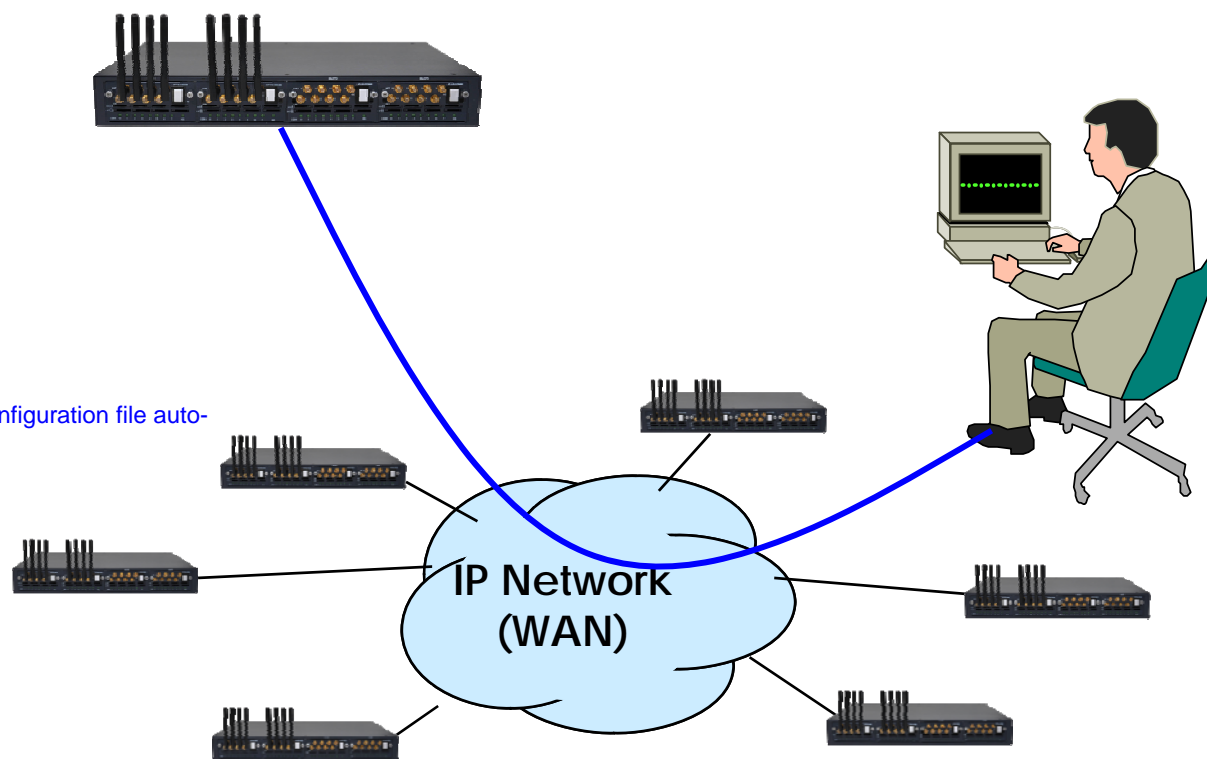

Smart Web Manager

AP-GV3100N 32-Port GSM VoIP Gateway

- **System Configuration**
 - Network Setup, Language, NAT, PPTP, NTP
- **Basic Configuration**
 - Protocol, SIP Server , FXS Extension, GSM Extension
 - DTMF/CODEC, VoIP Dial Plan, GSM Dial Plan, Static Routing, Hot Line
- **Advanced Configuration**
 - Gain/CID, GSM PINs, FAX, Service, Filtering, Security
 - GSM Web Callback, GSM Callback
- **Miscellaneous Configuration**
 - Call Status, System Status, Alarm Status, GSM Status
 - Call Log, System Log, Ping
- **LCR(Least Cost Routing)**
 - Black & White List, Time Interval, Tariff Group, LCR Test
- **SMS**
 - Inbox, SMS New Message

Smart Web Manager : Main Page Layout

AP-GV3100N 32-Port GSM VoIP Gateway

Main Menu
For easy system setup, provide the various menu and category

- System
 - Network Setup
 - Language
 - NAT
 - PPTP
 - NTP
- Basic
 - Protocol
 - Server SIP
 - SIP Registration
 - FXS Extension
 - GSM Extension
 - DTMF/CODEC
 - VoIP Dial Plan
 - GSM Dial Plan
 - Static Route
 - Hot Line
- Advanced
 - Gain & CID
 - GSM PINs
 - Fax
 - Service
 - Filtering
 - Security
 - SNMP
 - WEB Callback
 - GSM Callback

Tool Bar
Provide frequently used tools like as System Update, Configuration Backup, Initialization, Restart, Telnet

Information
Display the current system version and status summary

System Information	
H/W Version	2.0
SW Version	8.00d
MAC Address	0002.a400.0000
VoIP Protocol	SIP
Voice Interface Module	G(2)S(2)
Registration Status	Registered
Supported Codec List	
Network Information	Static 172.16.9.16
WAN LINK Status	100Mbps FULL Duplex Link UP
LAN LINK Status	Link Down
Current Time	Fri Jan 1 01:49:57 2010
System Startup Time	Fri Jan 1 00:00:00 2010
	0 days 01:49:57
	0

Workspace
Workspace for detailed action

Description
Display the help message if you move mouse over main menu

Information
AddPac Technology
Model : GS1002_G2
H/W Version : 2.0
S/W Version : 8.00d
Smart Web Version : 0.4
Smart Web Build : Mar 24 2010
Voice Interface : G(2)S(2)
Protocol : SIP
Status : Registered
CurrentCalls: 0 Call
Network : Static 172.16.9.16
Mac Address: 0002.a400.0000
Unread Message:
P0:0(0)
P0:1(0)

Description

Smart Web Manager : System – Network Setup

AP-GV3100N 32-Port GSM VoIP Gateway

The screenshot shows the 'Network Setup' page in the Smart Web Manager interface. The page is divided into several sections, each with a radio button for selection:

- Static IP:** Includes fields for IP Address (172.16.9.16), Network Mask (255.255.0.0), Default Router (172.16.1.1), and DNS Server (Primary and Secondary).
- PPPoE(ADSL):** Includes fields for Username and Password.
- DHCP:** A simple selection option.
- VLAN:** Includes a field for ID (0).
- WAN Link Control:** Includes options for Auto and Manual, and fields for Speed (100, 10) and Duplex (full, half).
- MAC(Hardware) Address:** A field for the MAC address.

On the right side, there is an 'Information' panel with details like Model (GS1002_G2), Smart Web Version (0.4), and Network (Static 172.16.9.16). Below it is a 'Description' panel with a note about WAN port setup. A yellow callout box points to the 'Unread Message' section in the Information panel, which shows 'P0:0(0)' and 'P0:1(0)'. Another yellow callout box points to the 'UnRead SMS Messages' section in the Description panel.

Host Name
Create a representative name for the site to be installed

Static IP
This is static IP mode. Specify the addressed IP from the service provider

PPPoE
This is ADSL mode. This mode is used for addressing IP though authentication from the modem.
At this time, the modem must be configured in a way that the device can be authenticated.

DHCP
This is dynamic IP mode which is set at default. The IP can addressed from the external DHCP server.

VLAN
Configure VLAN mode and ID.

WAN Link
Controls and recognizes WAN port
Specify the connection speed of WAN port. connection automatically.

MAC
Change MAC address of WAN interface. Without address entry, use the basic MAC Address.

UnRead SMS Messages

Smart Web Manager : Basic – GSM Extension

AP-GV3100N 32-Port GSM VoIP Gateway

Port Information
voice port type & physical port

GSM Extension
Configure GSM phone-number for receiving a call (usually 'T' is used for each port)

GSM Extension with Translation
Used to GSM callback
- The Received CID is not real serving number.
- The specified translation rule is applied.

Smart Web Manager
www.addpac.com

System

- Network Setup
- Language
- NAT
- PPTP

System

- Server SIP
- SIP Registration
- FXS Extension
- GSM Extension

Advanced

- Gain & CID
- GSM PINs
- Fax
- Service
- Filtering
- Security
- SNMP
- WEB Callback
- GSM Callback

Miscellaneous

- Call Status
- System Status
- Alarm Status
- GSM Status
- Call Log
- System Log
- Ping
- BTS Selection
- GSM BTS Info

GSM Extension

Port Information

Port	P0	P1	P2	P3
SLOT0	GSM	GSM	FXS	FXS

GSM Extension Configuration

Index	Port	Numbers	Preference	HuntStop	Select
0	0/0	T	0	X	<input type="checkbox"/>

GSM Extension with Translation

Port	Destination Pattern	Digits to Insert	Number of Digits to Delete
P0:0	33	8	1
P0:1			0

Information

AddPac Technology
Model : GS1002_G2
H/W Version : 2.0
S/W Version : 8.00d
Smart Web Version : 0.4
Smart Web Build : Mar 24 2010
Voice Interface
G(2)S(2)
Protocol : SIP
Status : Unregistered
CurrentCalls : 0 Call
Network : Static 172.16.9.16
Mac Address : 0002.a400.0000
Unread Message:
P0:0(0)
P0:1(0)

Description

Set up for using GSM port to extension number (forwarding No)

Security Management

AP-GV3100N 32-Port GSM VoIP Gateway

- IP packet filtering
- IP access list
- User authentication function
 - Password Authentication Protocol (PAP)
 - Challenge Handshake Authentication Protocol (CHAP)
- Enable/Disable specific protocols
- Auto-square connect of Telnet session
- Account Management function for multi-level user
- SNMP/TELNET/FTP/HTTP/TFTP port assignment function
- SNMP/TELNET/FTP access list management
- Boot mode security checking function

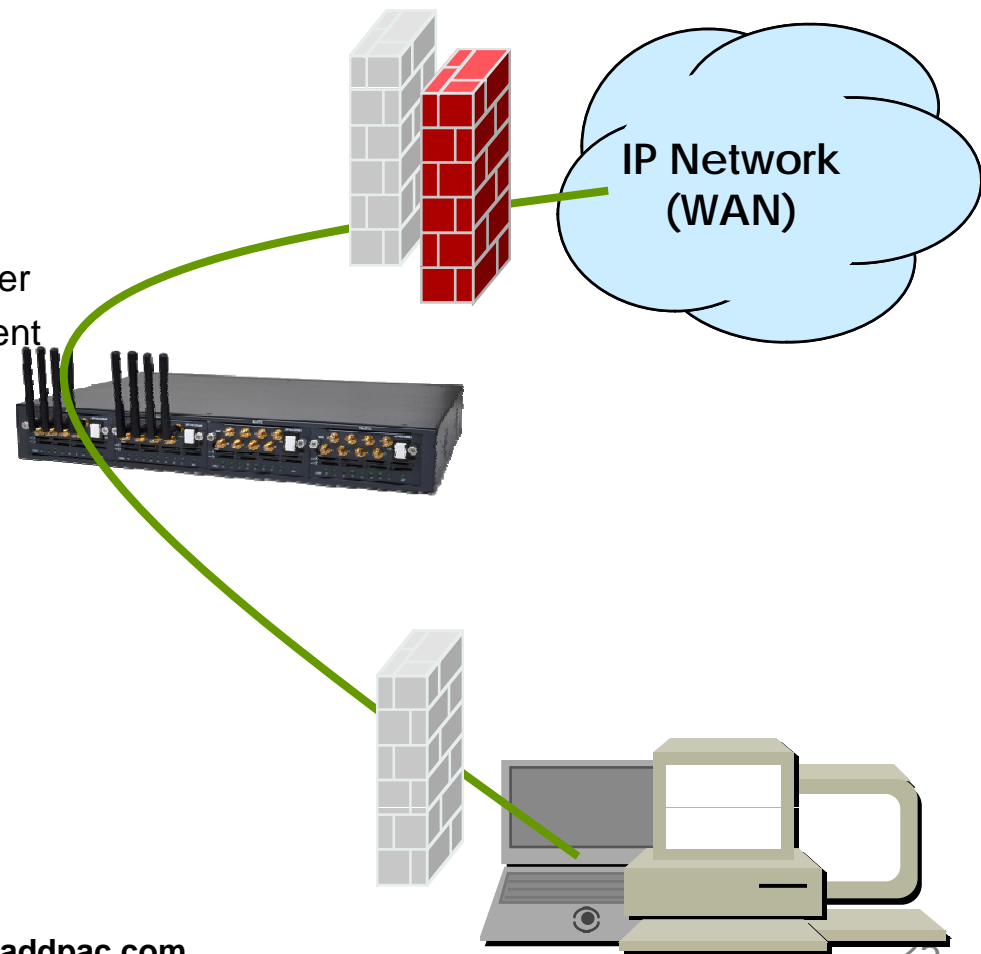

Standard Application (GSM Only)

AP-GV3100N 32-Port GSM VoIP Gateway

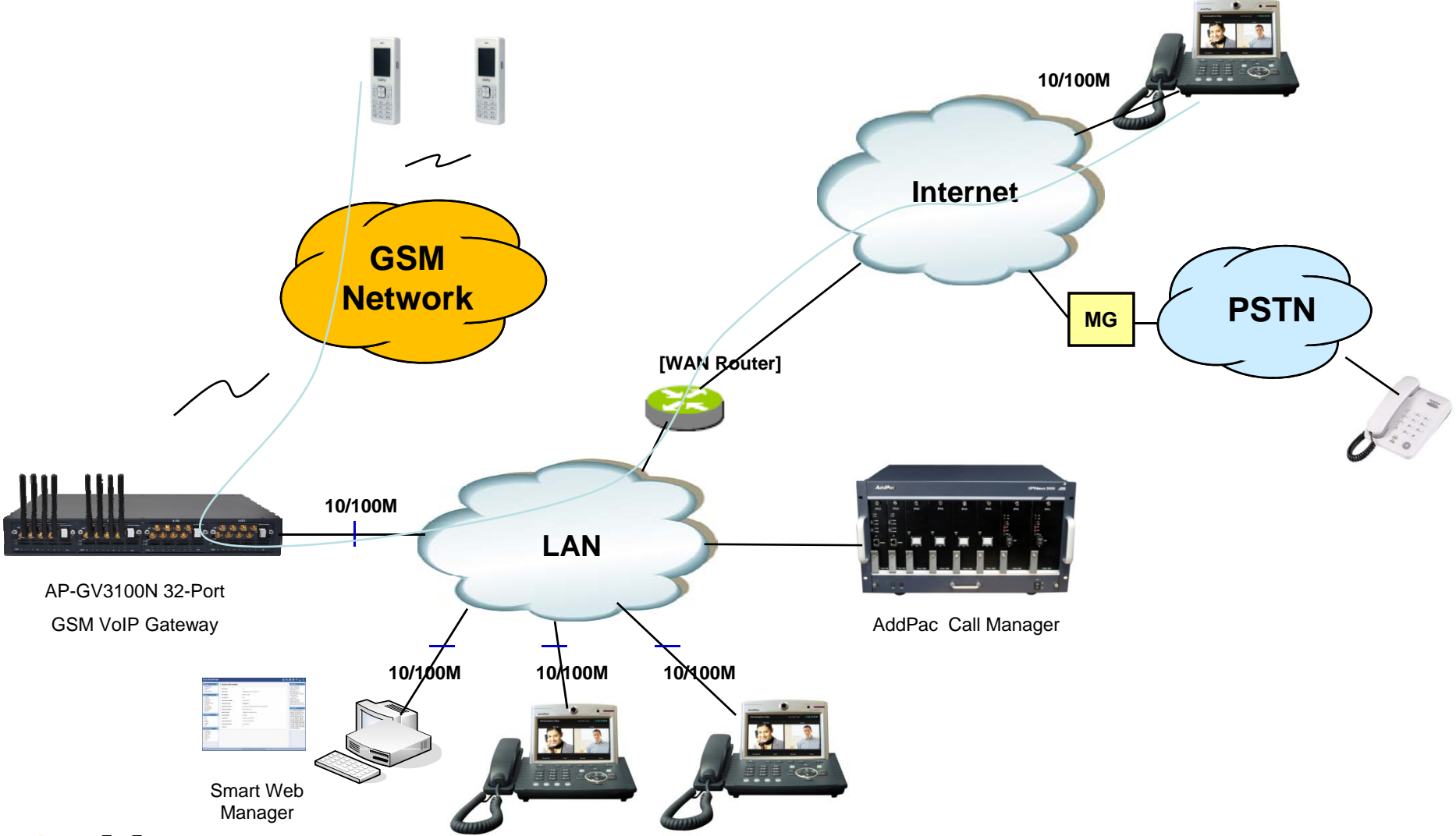

www.addpac.com

Ordering Information

- **AP-GV3100N GSM VoIP Gateway Hardware**
 - AP-GV3100N GSM VoIP Gateway Main Body
 - Four(4) Module Slots for GSM VoIP Interface Modules
 - RISC Microprocessor with High-end Programmable DSP Architecture
 - 2-port 10/100Mbps Fast Ethernet(RJ45)
 - 1-Port RS232C Console Interface(RJ45)
 - Option Module : AP-N5-GSM8I, AP-N5-GSM8SI, AP-N5-GSM8UI, etc
 - Including Network Cable, Antenna, etc.
- **Built-in APOS Internetworking Software for AP-GV3100N**
- **Including 1 Year Hardware Warranty**
- **Product Documents**
 - Install and Operation Guide (PDF)
- **Pricing**
 - AddPac Technology Regional Sales Manager
 - Authorized Sales and Marketing Representatives
 - Please Contact www.addpac.com

GSM Gateway Series

Thank you!

AddPac Technology Co., Ltd.
Sales and Marketing

Phone +82.2.568.3848 (KOREA)

FAX +82.2.568.3847 (KOREA)

E-mail sales@addpac.com