

Time Attendance + SIP Door Phone Solution (touch screen type)

Time Attendance SIP Video Door Phone Solution
(Touch screen type)

AP-TAS80 Time Attendance SIP Video Door Phone
AP-TAS150 Time Attendance SIP Video Door Phone
AP-ACS1000 IP Door Phone Control System
AP-SMP100 IP Soft Video Phone
AP-VP280 IP Video Phone

[Learn More >](#)



AddPac

AddPac Technology

Sales and Marketing

www.addpac.com

Contents

- Time Attendance + SIP Video Door Phone Service Diagram
- Time Attendance + SIP Video Door Phone Solution
 - AP-TAS150 (Fingerprint, RF card, SIP Video Call)
 - AP-TAS80 (RF card, SIP Video Call)
- Time Attendance Signal Call Flow Diagram
- Time Attendance Embedded Web Manager
- Backend Solution (other documents)
 - AP-VP280, AP-VP120 IP Video Phone
 - AP-VIC100 IP Video Intercom
 - AP-SMP100 IP Soft Video Phone
 - AP-ACS1000 Access Control Server

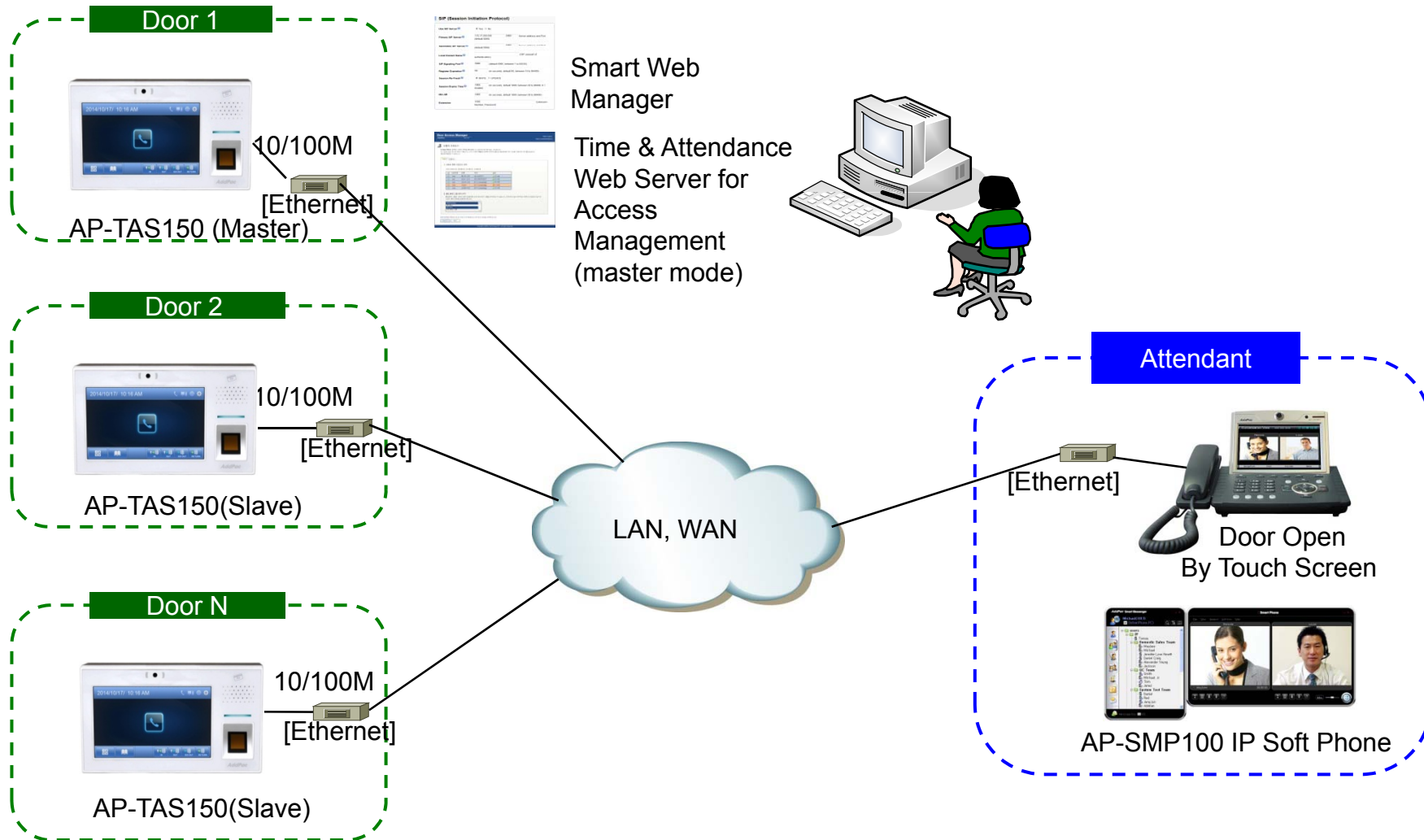

Time Attendance + SIP Video Door Phone Service Diagram





Time Attendance + SIP Video Door Phones

Time & Attendance SIP Door Phone Comparison Table

Model	AP-TAS150	AP-TAS80
Service Features		
Time & Attendance	Support	Support
SIP Door Phone	SIP Video Door Phone	SIP Video Door Phone
Duplex (Voice)	Full Duplex	Full Duplex
Key Pad	One(1) Call Button	One(1) Call Button
LCD	5 inch LCD	3.5 inch LCD
RF Card	Support	Support
Fingerprint	Support	N/A
Camera Sensor	SD(VGA)	SD(VGA)
Video Codec	SD, H.264/MPEG4/H.263	SD, H.264/MPEG4/H.263
Voice Codec	G.711,G722(option)	G.711, G.722(option)
Signaling	SIP	SIP
MIC & Speaker Phone	Support	Support
LAN Port	1	1
PoE(Optional)	Support	Support



Time Attendance SIP Video Door Phone AP-TAS150

Main Features

AP-TAS150 Time Attendance SIP Video Door Phone

- Smart Time & Attendance IP Video Door Phone Solution
- High Performance SIP Video Door Phone Solution
- Video Camera, Touch Screen TFT Color LCD, Internal MIC & Speaker
- High Quality 5 Inch LCD, 800 x 480 Video Resolution
- Fingerprint Recognition Support
- RF Card Support
- SIP VoIP Signaling Stack Embedded
- High-performance Video/Voice Codec Support
 - H.264/MPEG4/H.263, G.711, etc
- One(1) 10/100Mbps Fast Ethernet
- PoE(Power over Ethernet) Support
- High Quality Speaker Phone Features
- Powerful Acoustic Echo Canceller Chip Embedded
- Powerful Network Protocols (PPPoE, DHCP, Static Routing, etc)
- Firmware Upgradeable Architecture
- Advanced Voice QoS Mechanism

Hardware Specification

AP-TAS150 Time Attendance SIP Video Door Phone

- RISC+DSP Microprocessor Computing Power
- Audio and Voice Interface
 - Internal MIC
 - Internal Speaker
- Video Camera Interface
- TFT Color LCD Interface
 - 5 Inch LCD, 800 x 480 Video Resolution
- Network Interface
 - One(1) 10/100Mbps Fast Ethernet
- Fingerprint Recognition Interface
- RF Card Interface
- Alarm & Relay Out Interface (door open, etc)
- RS232/RS485 Interface
- Power Supply
 - Power over Ethernet (Option)
 - External Power Supply



Hardware Specification

AP-TAS150 Time Attendance SIP Video Door Phone

RISC
CPU

High-end
DSP

- **Acoustic Echo Canceller**
 - Full-duplex operation during double-talk situations
 - One channel AEC, one channel LEC up to 256ms shared
 - Cancels echoes with up to 10dB echo return
 - Advanced noise reduction(up to 20dB)
- **Speaker**
 - Impedance : 8 +/-15%ohm at 1kHz, 1.0 Vrms
 - Sound Pressure : 90 +/- 3dB at 0.1W/10 CM
at 800Hz, 1.0kHz, 1.2kHz, 1.5kHz
 - Resonance Level : 550Hz +/- 20%Hz at Fo Hz, 1.0Vrms
 - Frequency Range : Fo Hz ~20kHz
 - Input Power : Normal : 1.0 W, Max : 2.0W
- **Audio Amplifier**
 - 1-W BTL Output(5V, 0.11 % THD+N)
 - Uncompensated Gains of 2 to 20 (BTL Mode)
 - Thermal and Shot-circuit Protection
 - High Supply Ripple Rejection Ratio
- **PoE(Power over Ethernet)**
 - IEEE802.3af compliant
 - Input voltage range 36V to 57V
 - Short-circuit Protection

Hardware Specification

AP-TAS150 Time Attendance SIP Video Door Phone

RISC
CPU

High-end
DSP

- **LCD Controller**
 - One-Chip Solution for TFT-LCD
 - Hardware On-Screen Display (OSD)
 - Support resolution up to 240xRGBx320
 - Up to 24-bit RGB888 Digital Interface
 - Resize Function (x 1/16, x8)
 - BT.60/BT.66 Digital YCbCr 4:2:2(8-/16-bit) Interface
- **Camera**
 - High Sensitivity for low-light operation
 - Output support for Raw RGB, RGB, and YCrCb format
 - Image Size : VGA, QVGA, and any size scaling down from CIF to 40x30
 - Support AEC, AGC,AWB, ABF, ABLC
 - Saturation Level, Edge Enhancement Level, De-noise level Auto adjust

Hardware Specification

AP-TAS150 Time Attendance SIP Video Door Phone

RISC
CPU

High-end
DSP

- RF Card Sensor
 - Protocol Supported
 - ISO14443A/B all bit rates
 - > 106,212,424 and 848 kbps
 - Compatible to MiFare Classic
 - ISO15693 all modes
 - > 1.65/6.6 & 26.5 kbps
 - > Uplink 1 & 2 sub-carrier
 - Receiver
 - Rx Sensitivity down to 1mVrms
 - Rx Automatic Gain Control
 - Accept external baseband signal from external circuitry for frame level processing
 - Integrated signal strength indicator (SSI)
 - On-Chip Framing handler for supported standard
 - Transmitter
 - Typical proximity operating distance up to 100mm.
 - Software configurable modulation index
 - Maximum driving current up to 200 mA/PIN @ 5V
 - Accept external baseband signal for RF modulation
 - Wide Transmitter driver supply range from 2.7~7.0V



RF Card Sensor

Hardware Specification

AP-TAS150 Time Attendance SIP Video Door Phone

RISC
CPU

High-end
DSP

- Fingerprint Recognition
 - Sensor Type : Capacitive
 - Resolution(dpi) : 508
 - Sensing Area(mm) : 12.8 x18.0
 - Image Size(pixel) : 256 x 360
 - CPU : 400MHz DSP
 - Flash Memory : 4MB
 - ERR : < 0.1%
 - Enrollment Time : 800msec
 - 1:1 Verification Time : 800msec
 - 1:1000 Identification Time : 970msec
 - Template Size : 256~384bytes (configurable, 384bytes default)
 - Template Capacity : 9,000
 - Encryption : 256bit AES

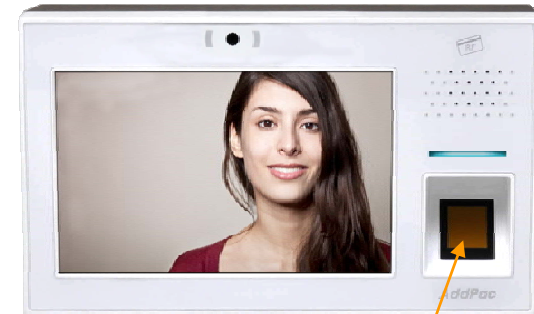

Fingerprint Recognition

Hardware Specification

AP-TAS150 Time Attendance SIP Video Door Phone

RISC
CPU

High-end
DSP

Front Side

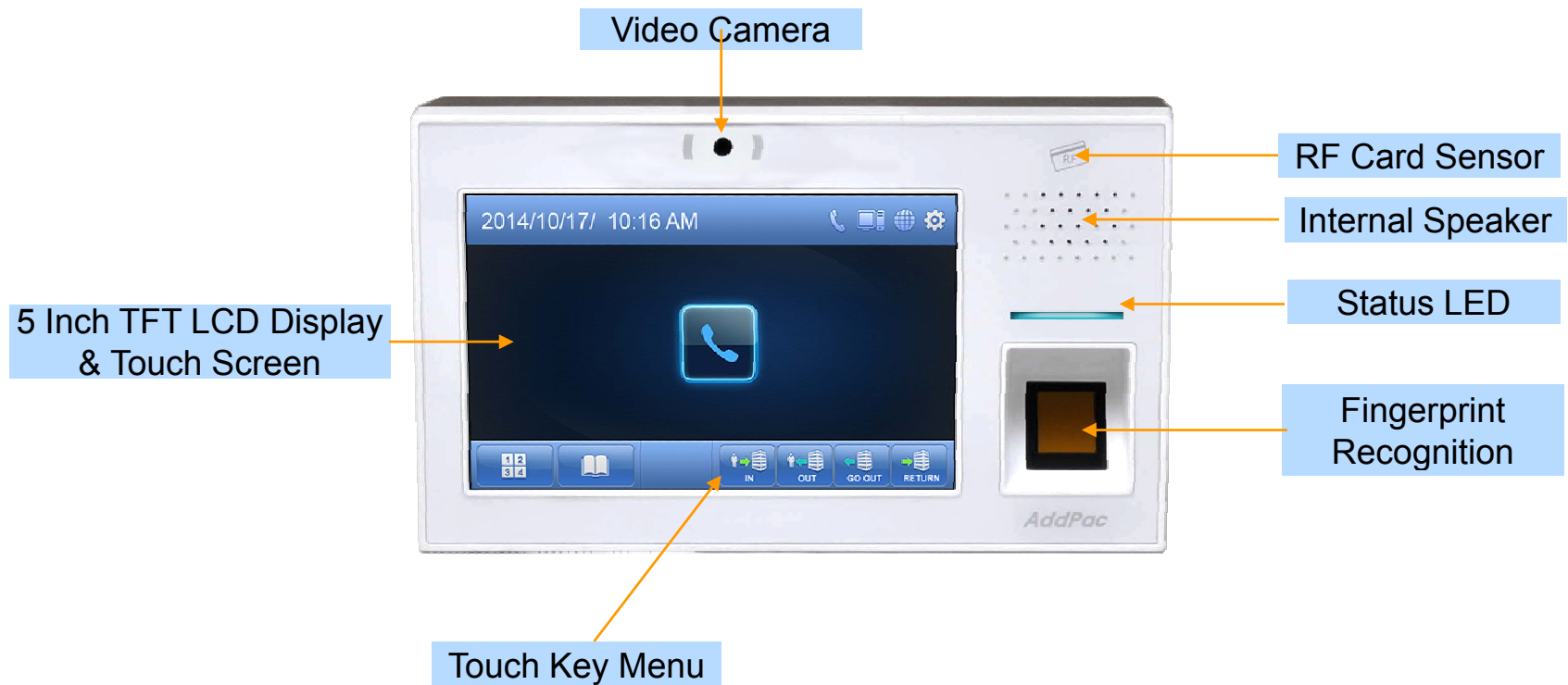

Hardware Specification

AP-TAS150 Time Attendance SIP Video Door Phone

RISC
CPU

High-end
DSP

Back Side

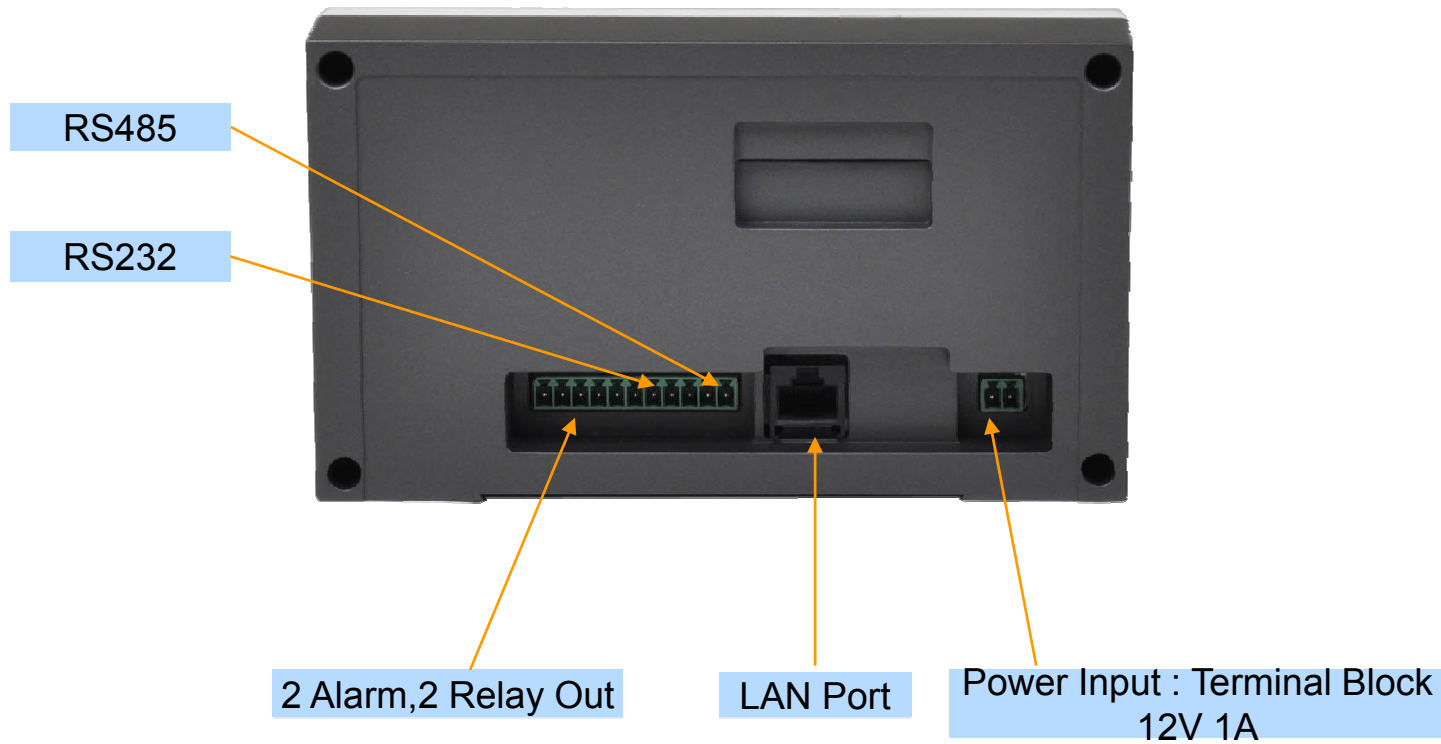

Hardware Specification

AP-TAS150 Time Attendance SIP Video Door Phone

RISC
CPU

High-end
DSP

Power Supply

Terminal Block



12V 1A Power Adaptor

Example





Time Attendance SIP Video Door Phone AP-TAS80

Main Features

AP-TAS80 Time Attendance SIP Video Door Phone

- Smart Time & Attendance IP Video Door Phone Solution
- High Performance SIP Video Door Phone Solution
- Video Camera, Touch Screen TFT Color LCD, Internal MIC & Speaker
- High Quality 5 Inch LCD, 800 x 480 Video Resolution
- RF Card Support
- SIP VoIP Signaling Stack Embedded
- High-performance Video/Voice Codec Support
 - H.264/MPEG4/H.263, G.711, etc
- One(1) 10/100Mbps Fast Ethernet
- PoE(Power over Ethernet) Support
- High Quality Speaker Phone Features
- Powerful Acoustic Echo Canceller Chip Embedded
- Powerful Network Protocols (PPPoE, DHCP, Static Routing, etc)
- Firmware Upgradeable Architecture
- Advanced Voice QoS Mechanism

Hardware Specification

AP-TAS80 Time Attendance SIP Video Door Phone

RISC
CPU

High-end
DSP

- RISC+DSP Microprocessor Computing Power
- Audio and Voice Interface
 - Internal MIC
 - Internal Speaker
- Video Camera Interface
- TFT Color LCD Interface
 - 5 Inch LCD, 800 x 480 Video Resolution
- Network Interface
 - One(1) 10/100Mbps Fast Ethernet
- RF Card Interface
- Alarm & Relay Out Interface (door open, etc)
- RS232/RS485 Interface
- Power Supply
 - Power over Ethernet (Option)
 - External Power Supply



Hardware Specification

AP-TAS80 Time Attendance SIP Video Door Phone

RISC
CPU

High-end
DSP

- **Acoustic Echo Canceller**
 - Full-duplex operation during double-talk situations
 - One channel AEC, one channel LEC up to 256ms shared
 - Cancels echoes with up to 10dB echo return
 - Advanced noise reduction(up to 20dB)
- **Speaker**
 - Impedance : 8 +/-15%ohm at 1kHz, 1.0 Vrms
 - Sound Pressure : 90 +/- 3dB at 0.1W/10 CM
at 800Hz, 1.0kHz, 1.2kHz, 1.5kHz
 - Resonance Level : 550Hz +/- 20%Hz at Fo Hz, 1.0Vrms
 - Frequency Range : Fo Hz ~20kHz
 - Input Power : Normal : 1.0 W, Max : 2.0W
- **Audio Amplifier**
 - 1-W BTL Output(5V, 0.11 % THD+N)
 - Uncompensated Gains of 2 to 20 (BTL Mode)
 - Thermal and Shot-circuit Protection
 - High Supply Ripple Rejection Ratio
- **PoE(Power over Ethernet)**
 - IEEE802.3af compliant
 - Input voltage range 36V to 57V
 - Short-circuit Protection

Hardware Specification

AP-TAS80 Time Attendance SIP Video Door Phone

RISC
CPU

High-end
DSP

- **LCD Controller**
 - One-Chip Solution for TFT-LCD
 - Hardware On-Screen Display (OSD)
 - Support resolution up to 240xRGBx320
 - Up to 24-bit RGB888 Digital Interface
 - Resize Function (x 1/16, x8)
 - BT.60/BT.66 Digital YCbCr 4:2:2(8-/16-bit) Interface
- **Camera**
 - High Sensitivity for low-light operation
 - Output support for Raw RGB, RGB, and YCrCb format
 - Image Size : VGA, QVGA, and any size scaling down from CIF to 40x30
 - Support AEC, AGC,AWB, ABF, ABLC
 - Saturation Level, Edge Enhancement Level, De-noise level Auto adjust

Hardware Specification

AP-TAS80 Time Attendance SIP Video Door Phone

RISC
CPU

High-end
DSP

- RF Card Sensor
 - Protocol Supported
 - ISO14443A/B all bit rates
 - > 106,212,424 and 848 kbps
 - Compatible to MiFare Classic
 - ISO15693 all modes
 - > 1.65/6.6 & 26.5 kbps
 - > Uplink 1 & 2 sub-carrier
 - Receiver
 - Rx Sensitivity down to 1mVrms
 - Rx Automatic Gain Control
 - Accept external baseband signal from external circuitry for frame level processing
 - Integrated signal strength indicator (SSI)
 - On-Chip Framing handler for supported standard
 - Transmitter
 - Typical proximity operating distance up to 100mm.
 - Software configurable modulation index
 - Maximum driving current up to 200 mA/PIN @ 5V
 - Accept external baseband signal for RF modulation
 - Wide Transmitter driver supply range from 2.7~7.0V

RF Card Sensor

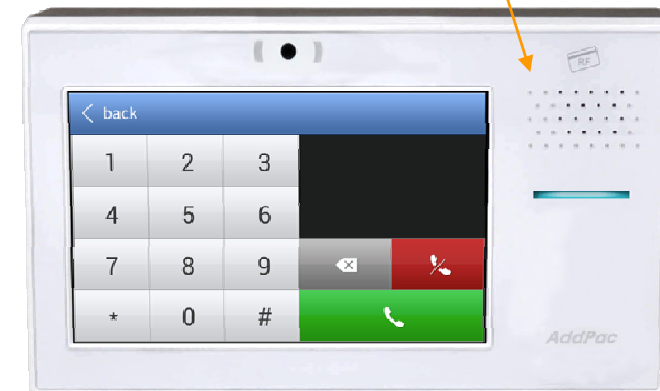

Hardware Specification

AP-TAS80 Time Attendance SIP Video Door Phone

RISC
CPU

High-end
DSP

Front Side

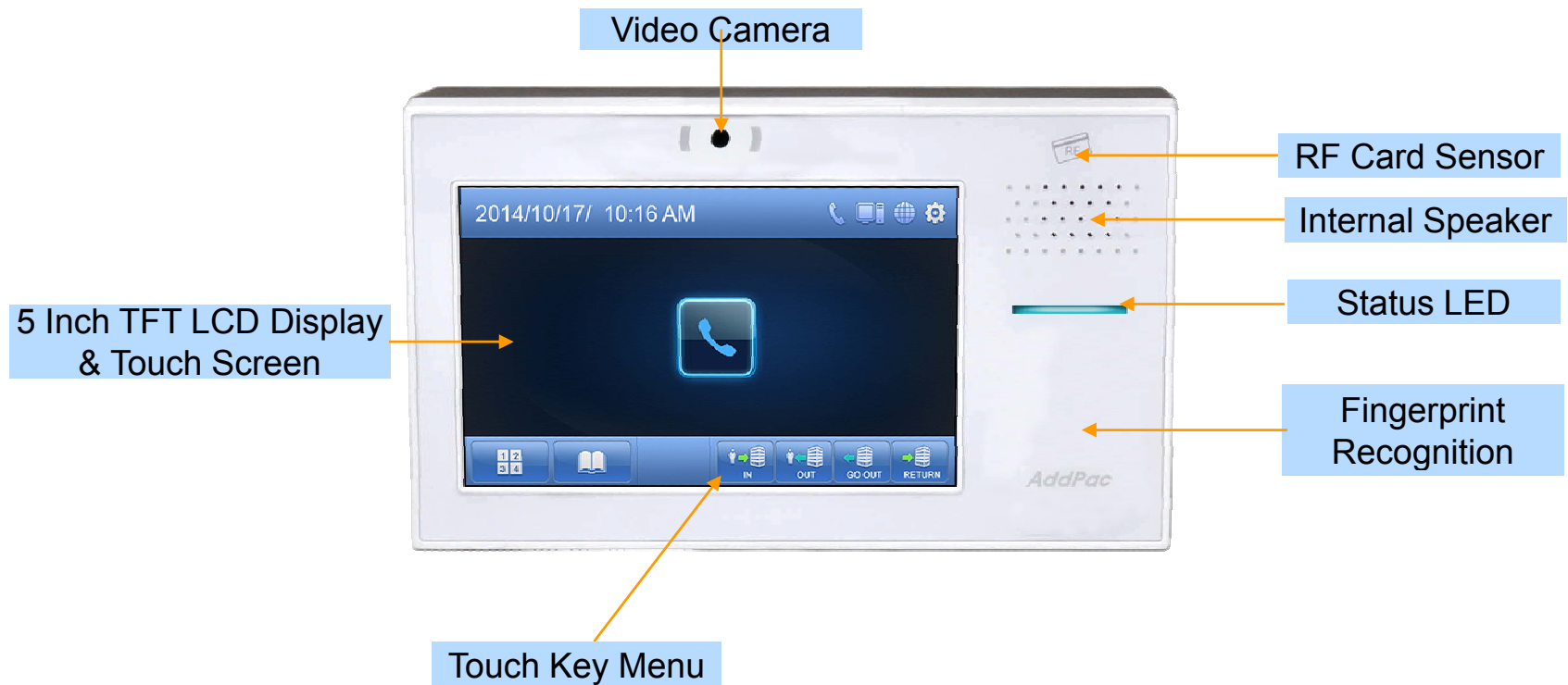

Hardware Specification

AP-TAS80 Time Attendance SIP Video Door Phone

RISC
CPU

High-end
DSP

Back Side

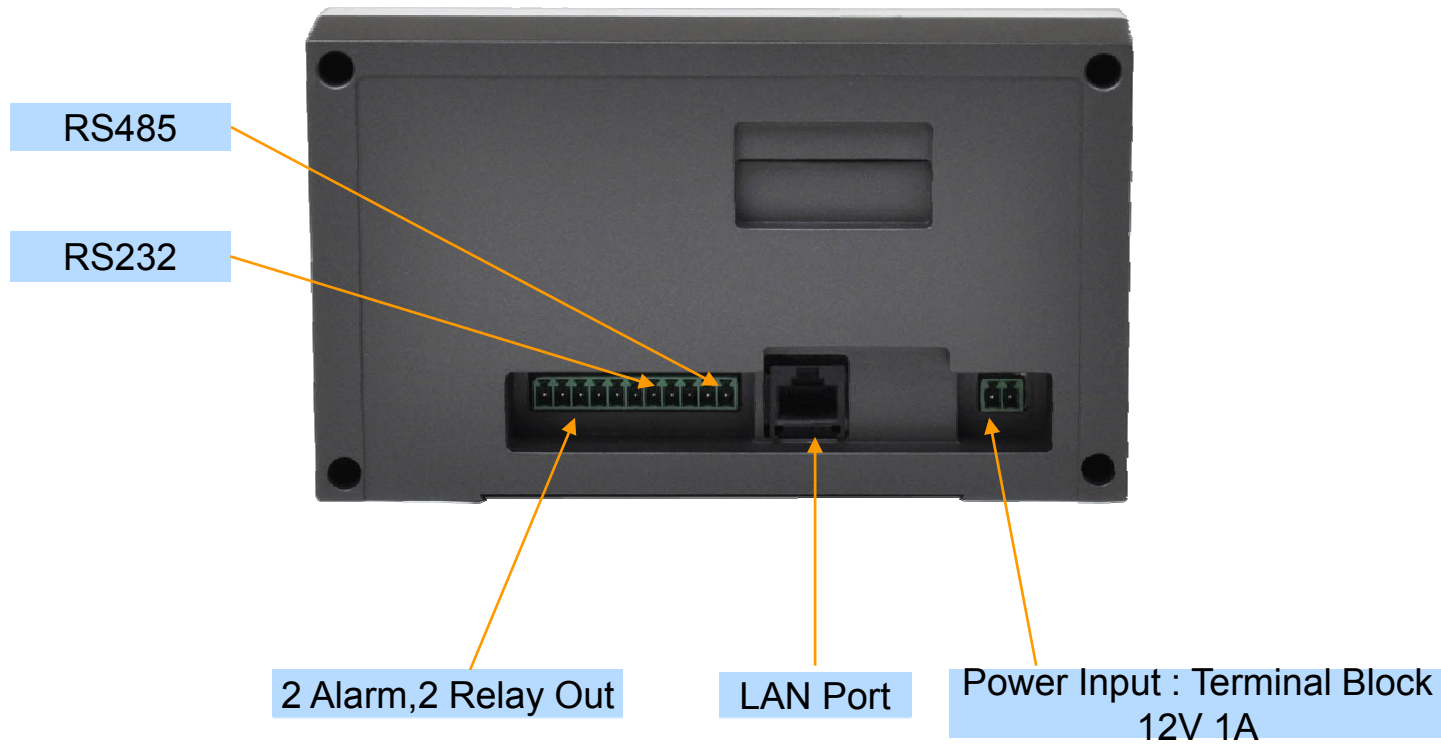

Hardware Specification

AP-TAS80 Time Attendance SIP Video Door Phone

RISC
CPU

High-end
DSP

Hardware Specification

AP-TAS80 Time Attendance SIP Voice Door Phone

RISC
CPU

High-end
DSP

Power Supply

Terminal Block



12V 1A Power Adaptor

Example





Time Attendance System Message Flow

Time & Attendance System Message Flow

Registration and KeepAlive

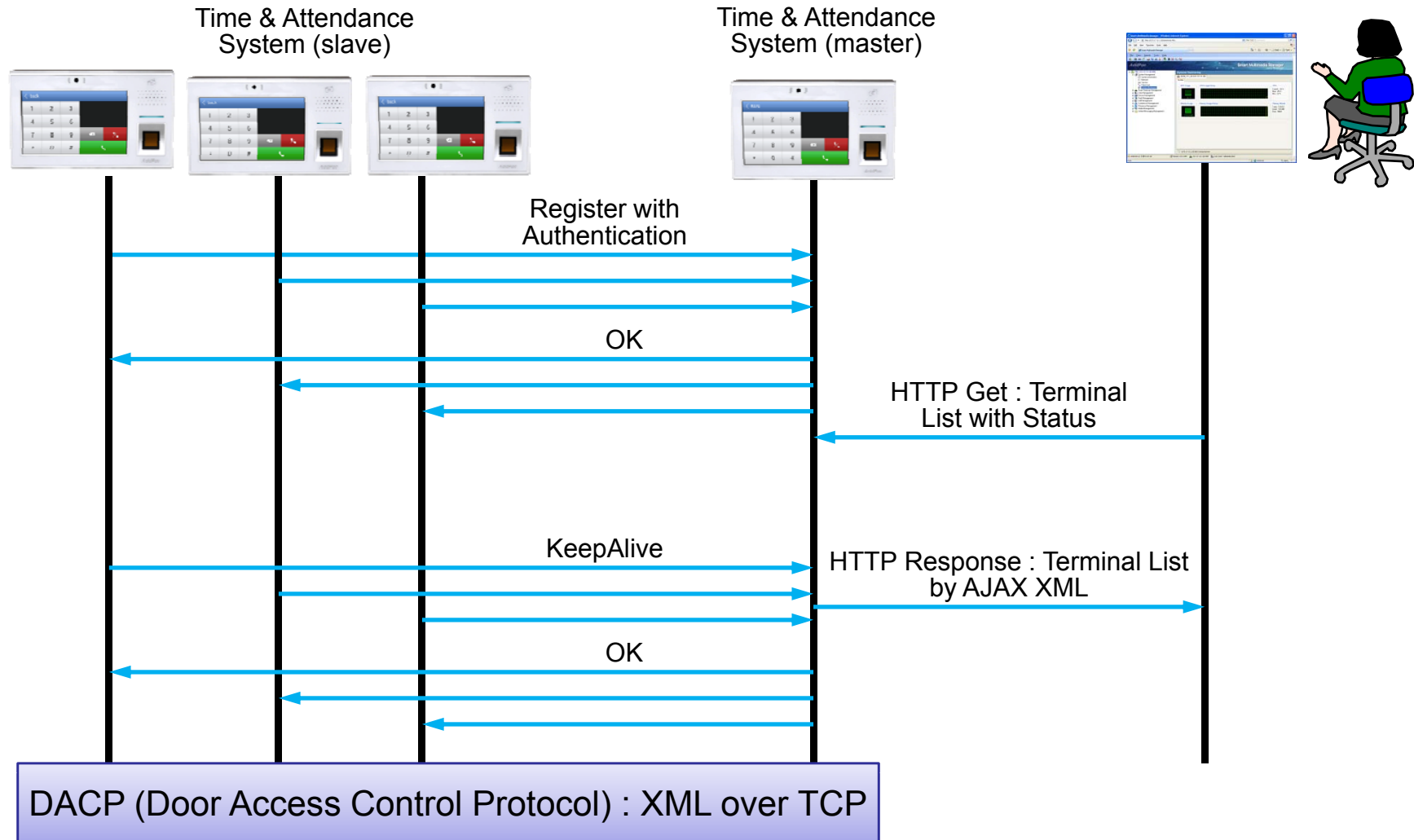

Time & Attendance System Message Flow

Access Privilege and Schedule Download

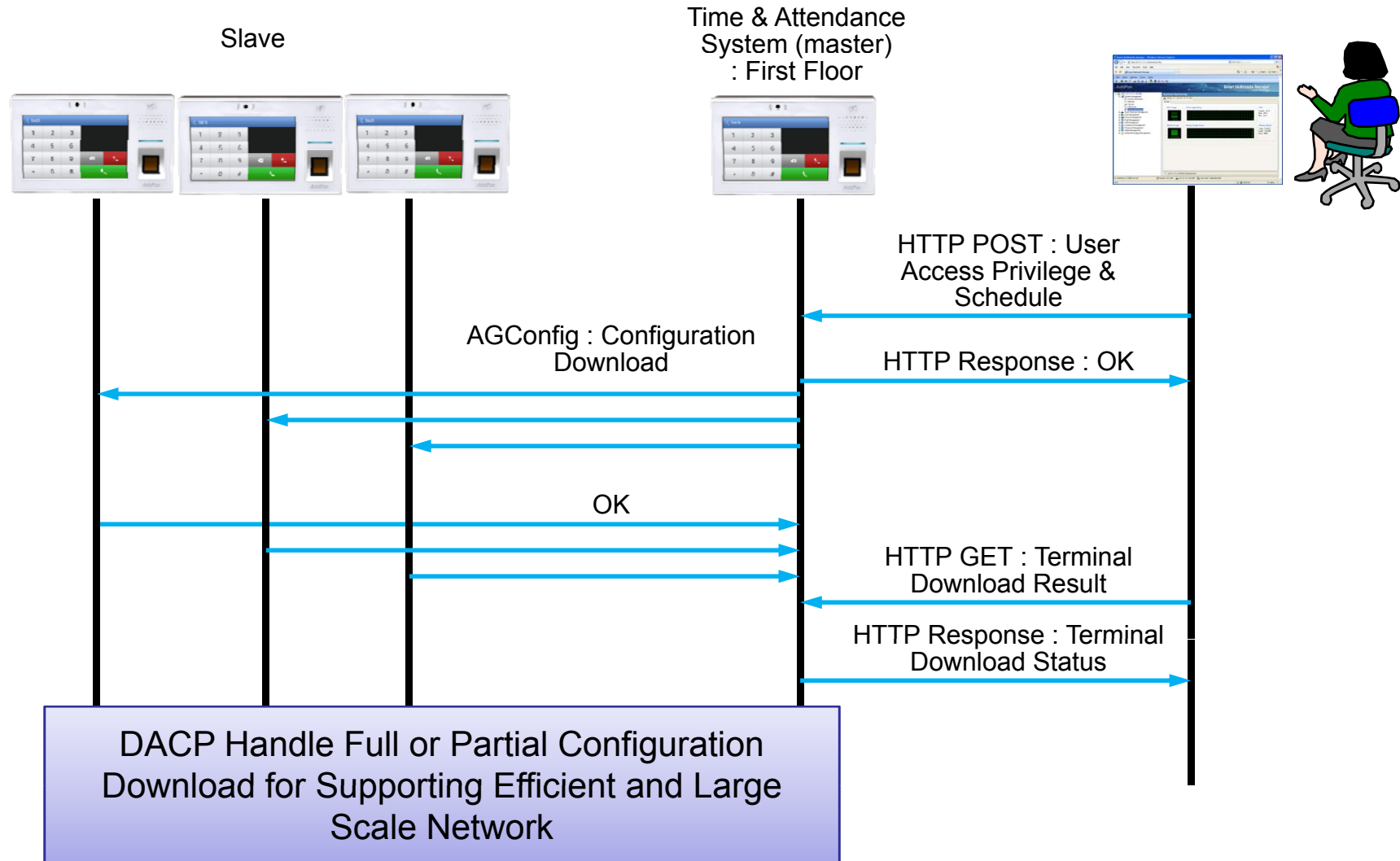

Time & Attendance System Message Flow

RF Card Read/Write and Registration

Time & Attendance System (slave)

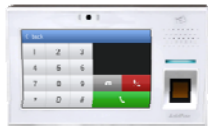

Time & Attendance System (master)

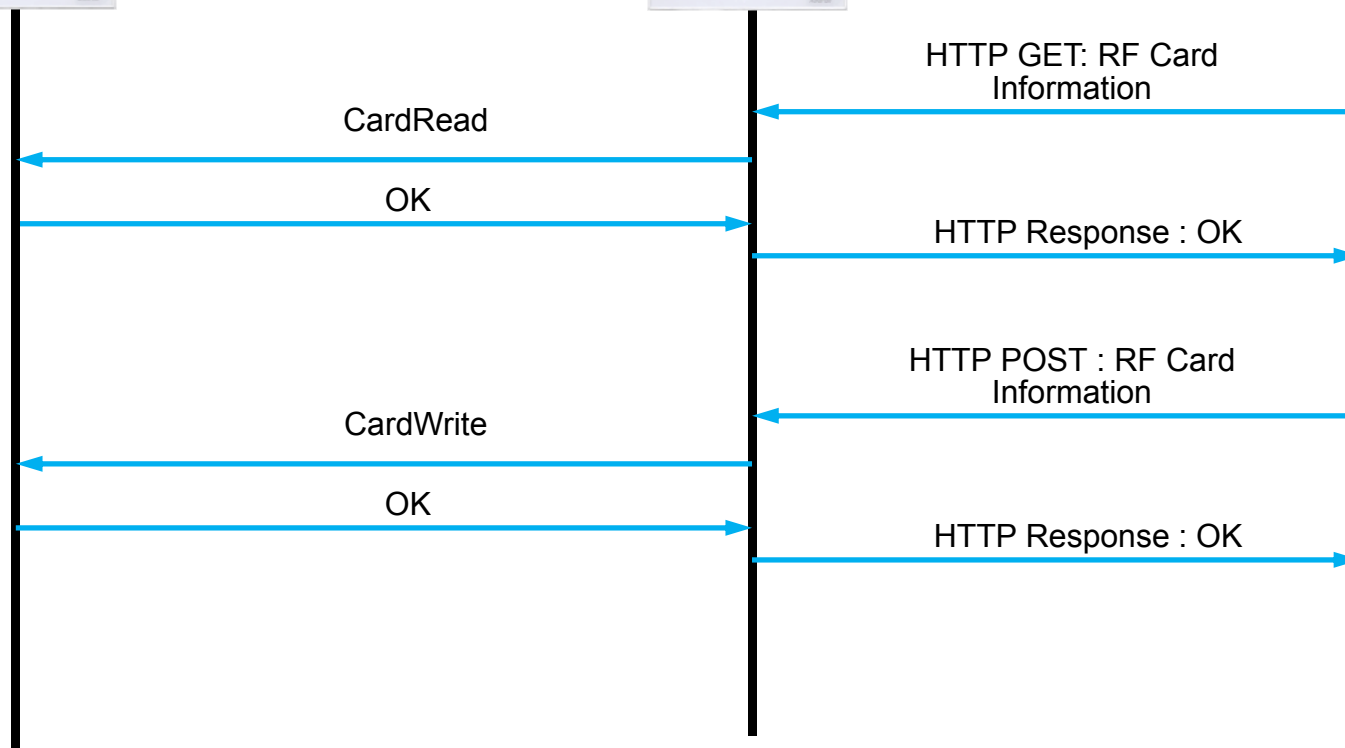
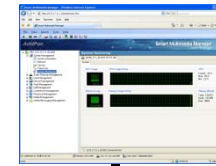
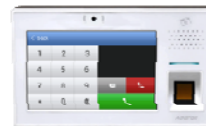

Time & Attendance System Message Flow

Door Open by RF Card

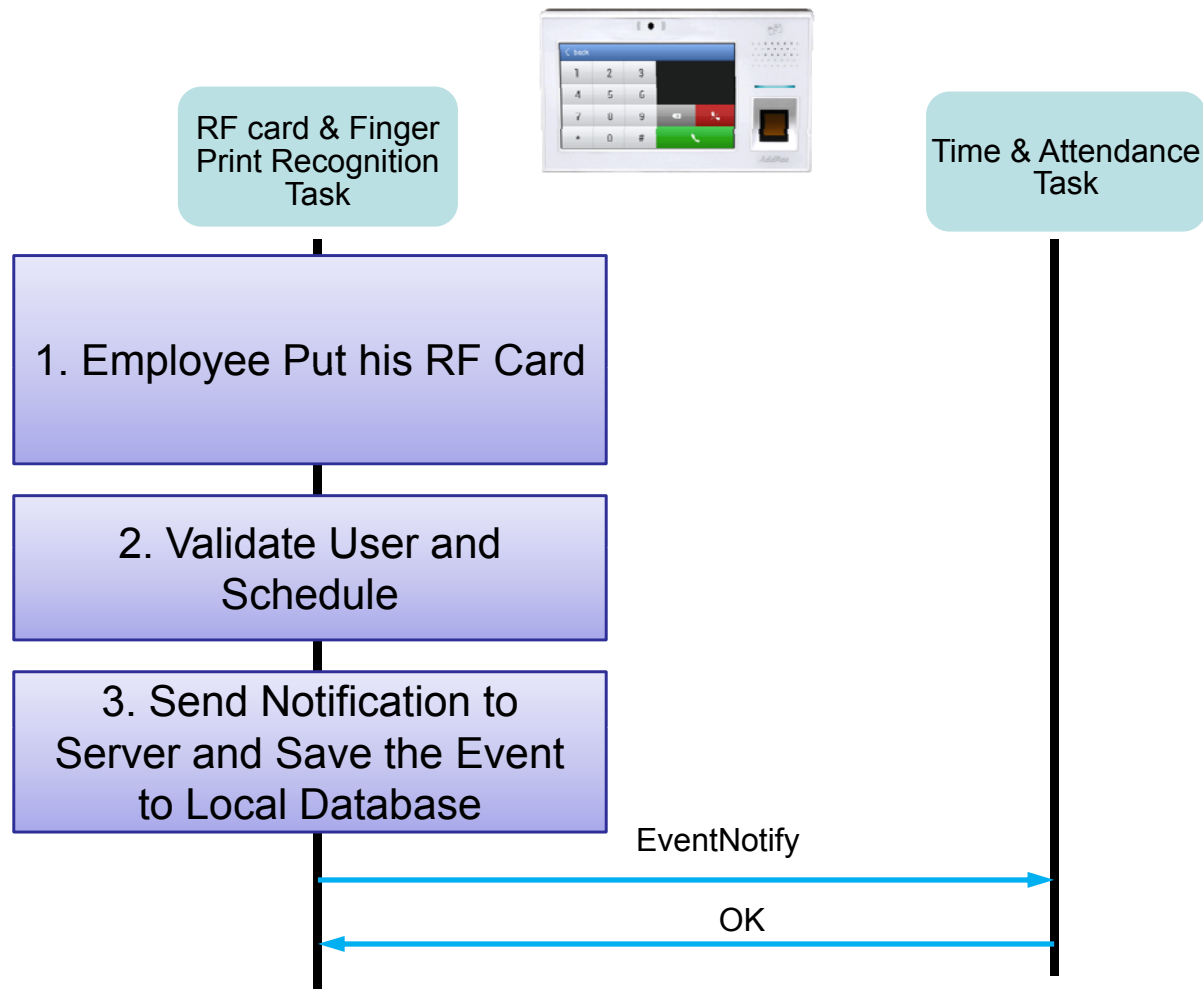

Time & Attendance System Message Flow

Door Open by Other Terminal

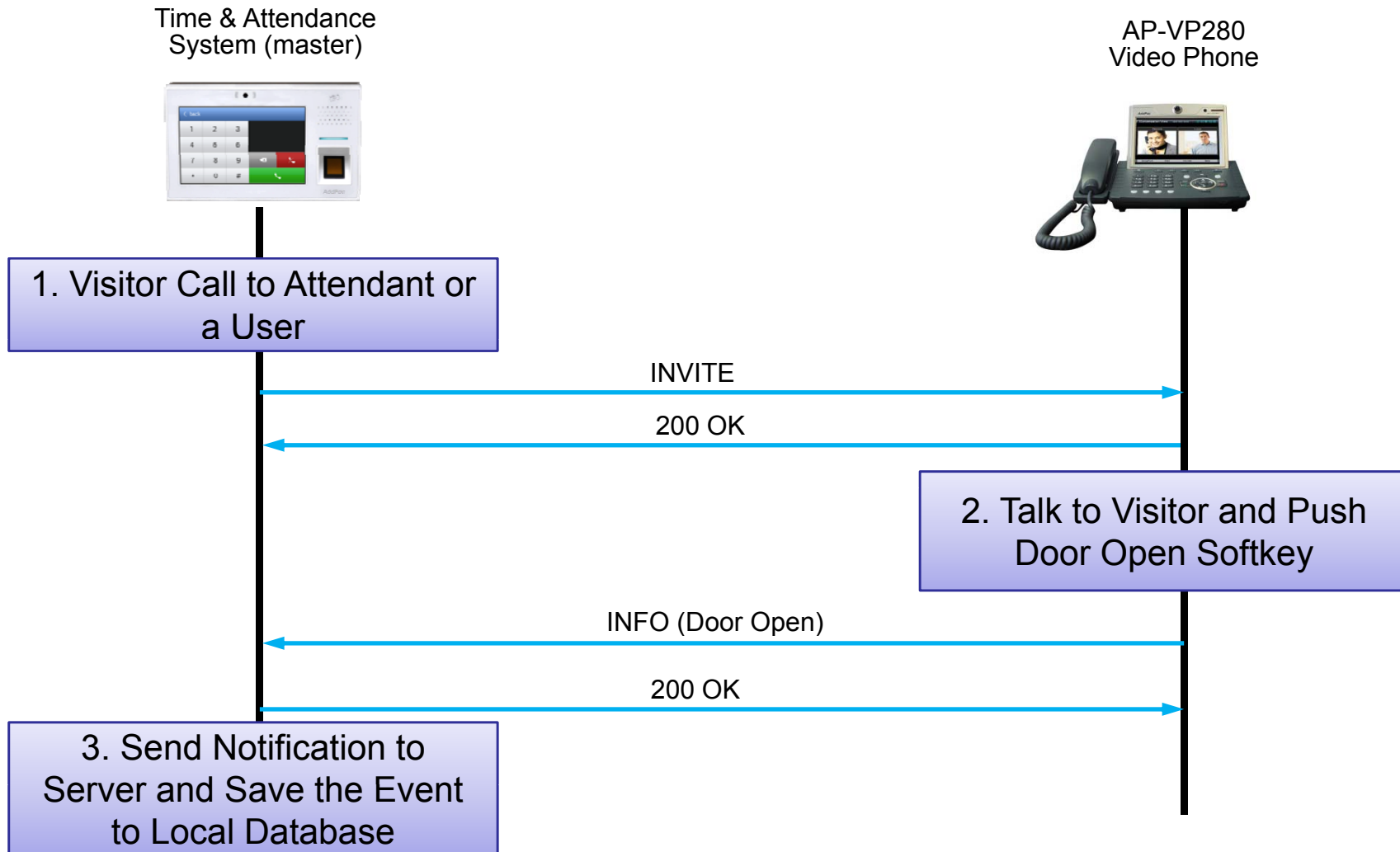



Time Attendance Embedded Web Manager Software

DACS (Door Access Control System)

Login page

The screenshot shows a web browser window with the URL `172.16.1.19/index.php`. The page title is "Door Access Control System". The main content area features the "AddPac Door Access Control System" logo and a login form with fields for "Administrator ID" (containing "root") and "Password" (masked with dots). Below the form are two buttons: "Door Access Control Manager" and "Time and Attendance Manager".

Annotations on the screenshot include:

- A yellow box at the top center containing the text: "You can log on 'Door Access Control Manager' or 'Time and Attendance Manager' if license is valid and administrator have authentication right". A yellow arrow points from this box to the login form.
- A blue box on the left containing the text: "Log on to Door Access Control Management". A blue arrow points from this box to the "Door Access Control Manager" button.
- A blue box on the right containing the text: "Log on to Time and Attendance Management". A blue arrow points from this box to the "Time and Attendance Manager" button.

TAAM (Time and Attendance Manager)

Daily Attendance Rules

shows In (office-in time), Out (office-out time) and Regular working time, for example 9 hours

Name	Description	In	Out	Regular Hour	Date Created
1 default rule	default daily rule	09:00	18:00	9 hr	
2 Factory First Rule	Factory first daily work rule	08:00	20:00	12 hr	2011-11-07 14:32:2
3 Factory Second Rule	Factory second daily work r...	20:00	08:00	9 hr	2011-11-07 14:33:1

This day rule can be used in the monthly rule for sunday through saturday each.

TAAM (Time and Attendance Manager)

Monthly Attendance Rules

Door Access Control System

172.16.1.19/dacm/monthlyWorkRuleList

Monthly Attendance Rule List
Shows list of monthly based attendance rule for time(week, full day off, national holiday)

Name	Description
1 Default Rule	Default attendance rule
2 Head Office Rule	Head office work monthly rule
3 Factory First Rule	Factory first work monthly rule
4 Factory Second Rule	Factory second work monthly rule

1. Monthly Rule
Defines day off or work day from starting first week to sixth week of the month. Each day of the week can be applied to daily-based attendance rule.

Rule Name*

Description

1st week: Sun Mon Tue Wed Thu Fri Sat

2nd week: Sun Mon Tue Wed Thu Fri Sat

3rd week: Sun Mon Tue Wed Thu Fri Sat

4th week: Sun Mon Tue Wed Thu Fri Sat

5th week: Sun Mon Tue Wed Thu Fri Sat

6th week: Sun Mon Tue Wed Thu Fri Sat

*Clicked: Full Day Off *Non-Clicked: Work Day

Sunday: N/A

Monday: N/A

Tuesday: N/A

Wednesday: N/A

Thursday: N/A

Friday: N/A

Saturday: N/A

2. Holiday Rule
Defines rule for non-working day such as national holiday, user defined holiday in the day template.

Day Template List

Name	Description
public holiday	public holiday description
company holiday	company holiday description

List of applied Day Templates

Name	Description
------	-------------

Annotations:

- Day of week rule from 1st week to 6th week and grey color means full day off, other color is work day
- You can specify daily rule from the list for sunday through saturday

AddPac Copyright © AddPac 1999-2011 All Rights Reserved

TAAM (Time and Attendance Manager) Business Trip and Vacation

The screenshot shows the 'Business Trip and Vacation' section of the TAAM application. It features a table with two entries and three callout boxes explaining specific details.

Name	Description	User	Type	Start	End	Date Created	Modify	Delete
1 Rusia Business...	Presentation for Ne...	Total 2 includin...	Business trip	2011-09...	2011-10...			
2 Summer Vacati...			Vacation	2011-08...	2011-08...	2011-10-12 07:...		

Annotations:

- one or more user can be specified for each business trip and vacation rule.** (Points to the 'User' column)
- Extension user will be not processed as absentee between start day and end day, also log as user-defined time attendance code** (Points to the 'Type' column)
- user-defined time and attendance code for attendance report or log correction** (Points to the 'Date Created' column)

Page 1 of 1 Total: 2

AddPac Copyright © AddPac 1999-2011 All Rights Reserved Version 1.1.14

TAAM (Time and Attendance Manager)

Time and Attendance Codes

The screenshot shows the 'Time and Attendance Manager' web application. The browser address bar displays '172.16.1.19/dacm/timeAttendanceCodeList'. The page title is 'Time and Attendance Manager' and the user is logged in as 'root'. The main content area is titled 'Time and Attendance Codes' and includes a description: 'Shows list of user defined attendance code which can be used as correction in the attendance report.' Below this is a table with columns for Name, Description, Date Created, Modify, and Delete. A 'Add a Code' button is located to the right of the table. Three callout boxes provide additional information: one pointing to the table header, one pointing to the 'Sick Leave' row, and one pointing to the 'Delete' column.

Name	Description	Date Created	Modify	Delete
1 Unknown				
2 Not yet defined				
3 Late In				
4 Early Out				
5 Absence				
6 Late In/Early Out				
7 Normal				
8 Vacation				
9 Business trip				
10 Sick Leave	Sick Leave code by admin	2011-11-07 14:44:15		

system built-in time and attendance code is provided as default, for example late-in, early-out and absence

show built-in and user-defined time and attendance code which will be used in the attendance report and log correction

only user-define code can be removed if needed

TAAM (Time and Attendance Manager) Delivery Policy for Attendance Report

1. Report Policy
Defines email delivery policy for manager or each user to receive daily, monthly attendance report.

Send reports to the particular person every day at 08:00

Send reports to the particular person at specific day (28) of every month.

User List

Name	Department	Extension
------	------------	-----------

Applied user list

Name	Department	Extension
batista Eike	/2F/	1000
Stefan Persson	/2F/	1016

Send personal monthly report to each user.

2. SMTP Server
You can specify sending email server(SMTP) configurations.

SMTP Server: 61.33.161.2

Sender Email Address: dacs_admin@company.com

Server Authentication Required

User ID: admin

Password: ****

To apply this features, select 'Apply' or 'Cancel'

Apply Cancel

manager level users (extension) list who want to receive daily and monthly attendance report

if checked, system will send personal attendance report of each month to extension user

TAAM (Time and Attendance Manager)

Attendance Report by Date

Time and Attendance Manager

Mon Nov 7 14:52:05 2011 Help | Logout root

Home Policy Trip and Vacation Report Configuration Report View

Attendance Report by Date
Shows attendance log for each user and summary information with specified day.

Select Date : 2011-10-19

Select Department : All

Attendance Report by Date (2011-10-19)

Username	Department	In	Out	Overtime	Office Hc	Result	Correction Ti	Correct
1 Eike batista	smart management팀	08:05:00	18:05:00	0 hr	10:0...	Normal		
2 Bill Gates	multimedia팀	09:15:00	17:15:00	0 hr	08:0...	Normal	2011-11-...	
3 Larry Ellison	multimedia팀	09:00:00	18:00:00	0 hr	09:0...	Normal		
4 karl Albrecht	smart framework팀	09:00:00	17:00:00	0 hr	08:0...	Early Out		
5 Carlos Slim Helu	smart management팀	09:10:00	19:10:00	0 hr	10:0...	Normal		
6 Lakshmi Mittal	multimedia팀	09:00:00	18:00:00	4 hr	09:0...	Normal		
7 Christy Walton	smart framework팀	09:00:00	18:00:00	0 hr	09:0...	Normal		

You can export to excel or print out for attendance report

attendance summary for each time and attendance code with specified date

administrator may adjust or correct attendance log which system have processed if necessary

TAAM (Time and Attendance Manager)

Attendance Report Excel Export

Attendance Report by Date (2011-10-19)							
Username	Department	In	Out	Overtime	Office Hours	Result	Correction Time
Eike batista	smart management	08:05:00	18:05:00	0 hr	10:00:00	Normal	
Bill Gates	multimedia	09:15:00	17:15:00	0 hr	08:00:00	Normal	2011-11-07 14:52:28
Larry Ellison	multimedia	09:00:00	18:00:00	0 hr	09:00:00	Normal	
karl Albrecht	smart framework	09:00:00	17:00:00	0 hr	08:00:00	Early Out	
Carlos Slim Helu	smart management	09:10:00	19:10:00	0 hr	10:00:00	Normal	
Lakshmi Mittal	multimedia	09:00:00	18:00:00	4 hr	09:00:00	Normal	
Christy Walton	smart framework	09:00:00	18:00:00	0 hr	09:00:00	Normal	
Lika Shing	smart framework	09:20:00	18:20:00	0 hr	09:00:00	Late In	
Stefan Persson	smart framework	09:00:00	20:00:00	2 hr	11:00:00	Normal	
Warren Buffett	multimedia	09:15:00	18:15:00	0 hr	09:00:00	Normal	
Amancio Ortega	smart management	09:00:00	21:00:00	3 hr	12:00:00	Normal	
Mukesh Ambani	smart management	09:00:00	18:30:00	0 hr	09:30:00	Normal	

TAAM (Time and Attendance Manager)

Attendance Report by Month



attendance summary for each time and attendance code with specified month

attendance summary for each extension user

TAAM (Time and Attendance Manager)

Attendance Daily Report by Month

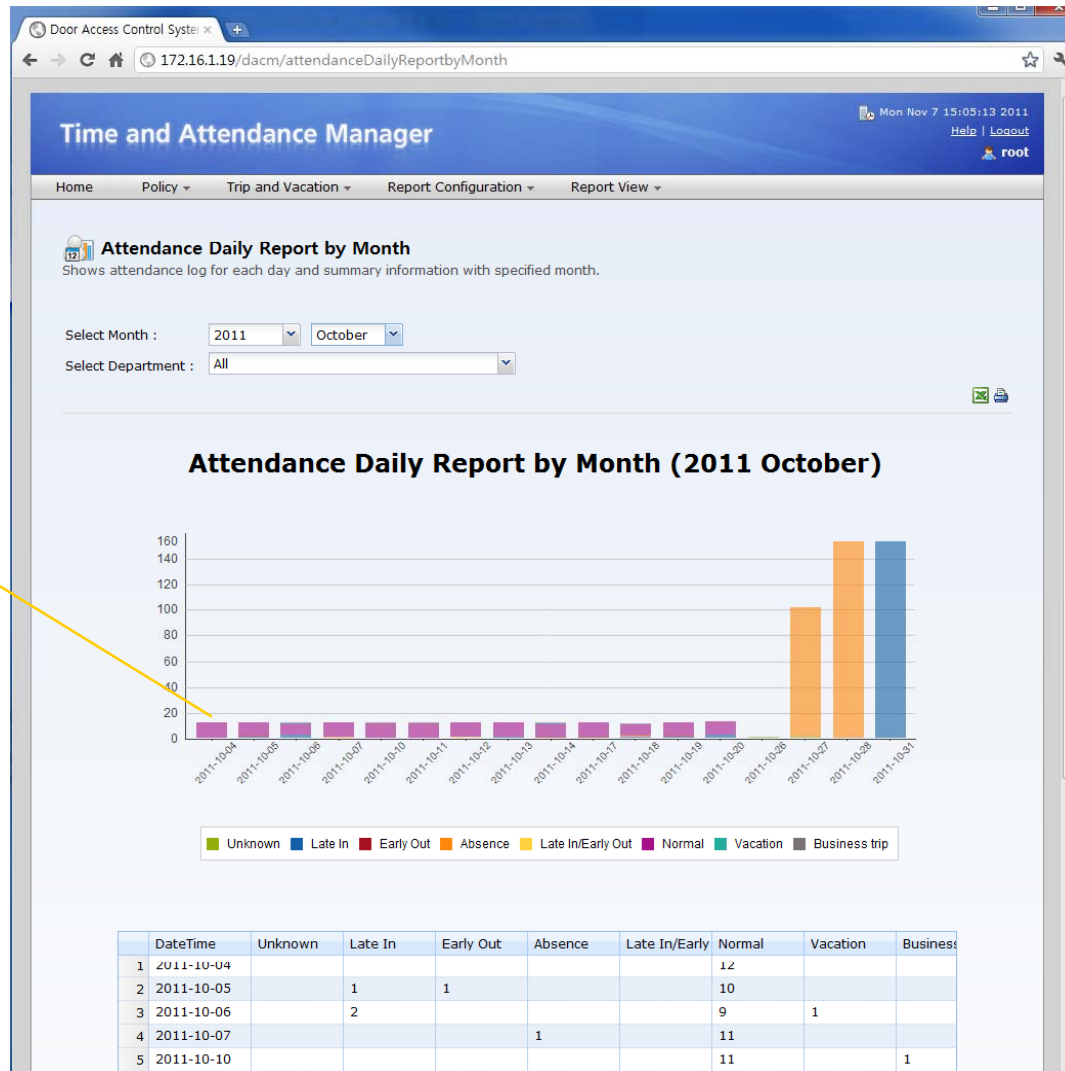

clustered column of attendance summary with time span from first to end of the month

TAAM (Time and Attendance Manager) Attendance Personal Report

Attendance Personal Report
Shows attendance log of each day for the month with specified user.

Select Month : 2011 | October
Select User : Carlos slim Helu

Attendance Personal Report (2011 October)
Carlos slim Helu (/2F/)

Type

Type	Count
Late In	1
Early Out	2
Absence	1
Normal	10
Business trip	1

	DateTime	In	Out	Overtime	Office Hours	Result
1	2011-10-04	09:00:00	18:00:00	0 hr	10:00:00	Normal
2	2011-10-05	09:00:00	18:00:00	0 hr	10:00:00	Normal
3	2011-10-06	09:00:00	18:00:00	0 hr	10:00:00	Normal
4	2011-10-07	09:00:00	18:00:00	0 hr	10:00:00	Normal
5	2011-10-10	09:10:00	19:10:00	0 hr	10:00:00	Normal
6	2011-10-11	09:10:00	19:10:00	0 hr	10:00:00	Normal
7	2011-10-12	09:10:00	19:10:00	0 hr	10:00:00	Normal
8	2011-10-13	09:10:00	19:10:00	0 hr	10:00:00	Normal
9	2011-10-14	09:10:00	17:10:00	0 hr	08:00:00	Early Out

You can specify one extension user for attendance report of the month

attendance summary for time and attendance code of a extension user



Thank you!

AddPac Technology Co., Ltd.
Sales and Marketing

Phone +82.2.568.3848 (KOREA)

FAX +82.2.568.3847 (KOREA)

E-mail : sales@addpac.com