

# AP-VAC150

## IP Video Door Phone

Fingerprint Recognition IP Video Door Phone Solution

### Preliminary Product Overview

(Without notice, following described technical spec. can be changed)



**AddPac**

**AddPac Technology**

Sales and Marketing

[www.addpac.com](http://www.addpac.com)

# Contents

- Product Overview
- Product Highlights
- Hardware Specification
- Software Service
- Video Service & Features
- Audio & Voice Service and Features
- OSD Software Features
- Smart Web Manager
- Application Area
- Ordering Information



# Product Overview

## AP-VAC150 Fingerprint Recognition IP Video Door Phone

- High Performance IP Video Door Phone Solution
- Video Camera, Touch Screen TFT Color LCD, Internal MIC & Speaker
- High Quality 5 Inch LCD, 800 x 480 Video Resolution
- Fingerprint Recognition Support
- RF Card Support
- SIP VoIP Signaling Stack Embedded
- High-performance Video/Voice Codec Support
  - H.264/MPEG4, G.711, etc
- One(1) 10/100Mbps Fast Ethernet
- PoE(Power over Ethernet) Support
- High Quality Speaker Phone Features
- Powerful Acoustic Echo Canceller Chip Embedded
- Powerful Network Protocols (PPPoE, DHCP, Static Routing, etc)
- Firmware Upgradeable Architecture
- Advanced Voice QoS Mechanism

# Product Highlights

AP-VAC150 Fingerprint Recognition IP Video Door Phone

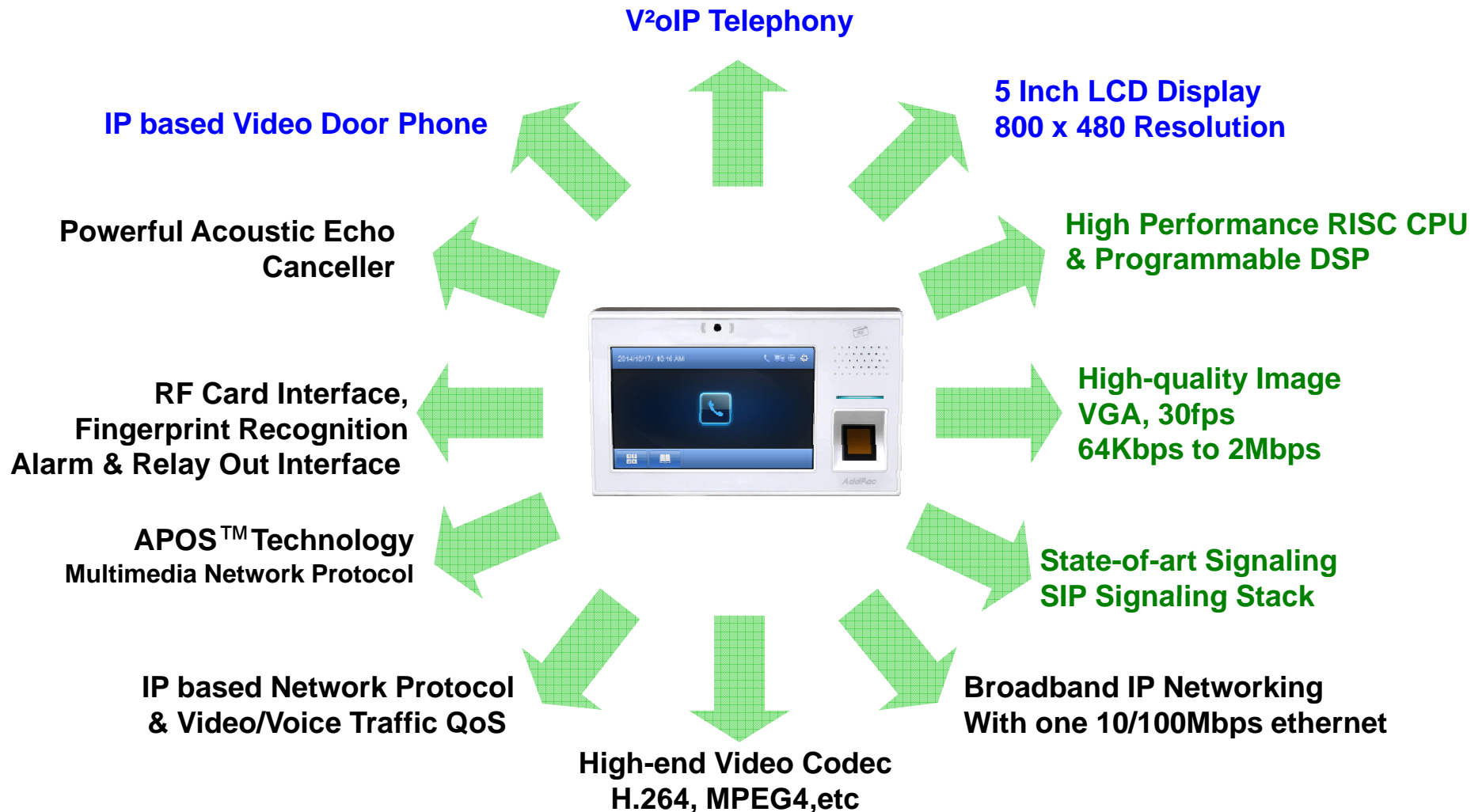

**AddPac**

[www.addpac.com](http://www.addpac.com)

# Multimedia Service

AP-VAC150 Fingerprint Recognition IP Video Door Phone

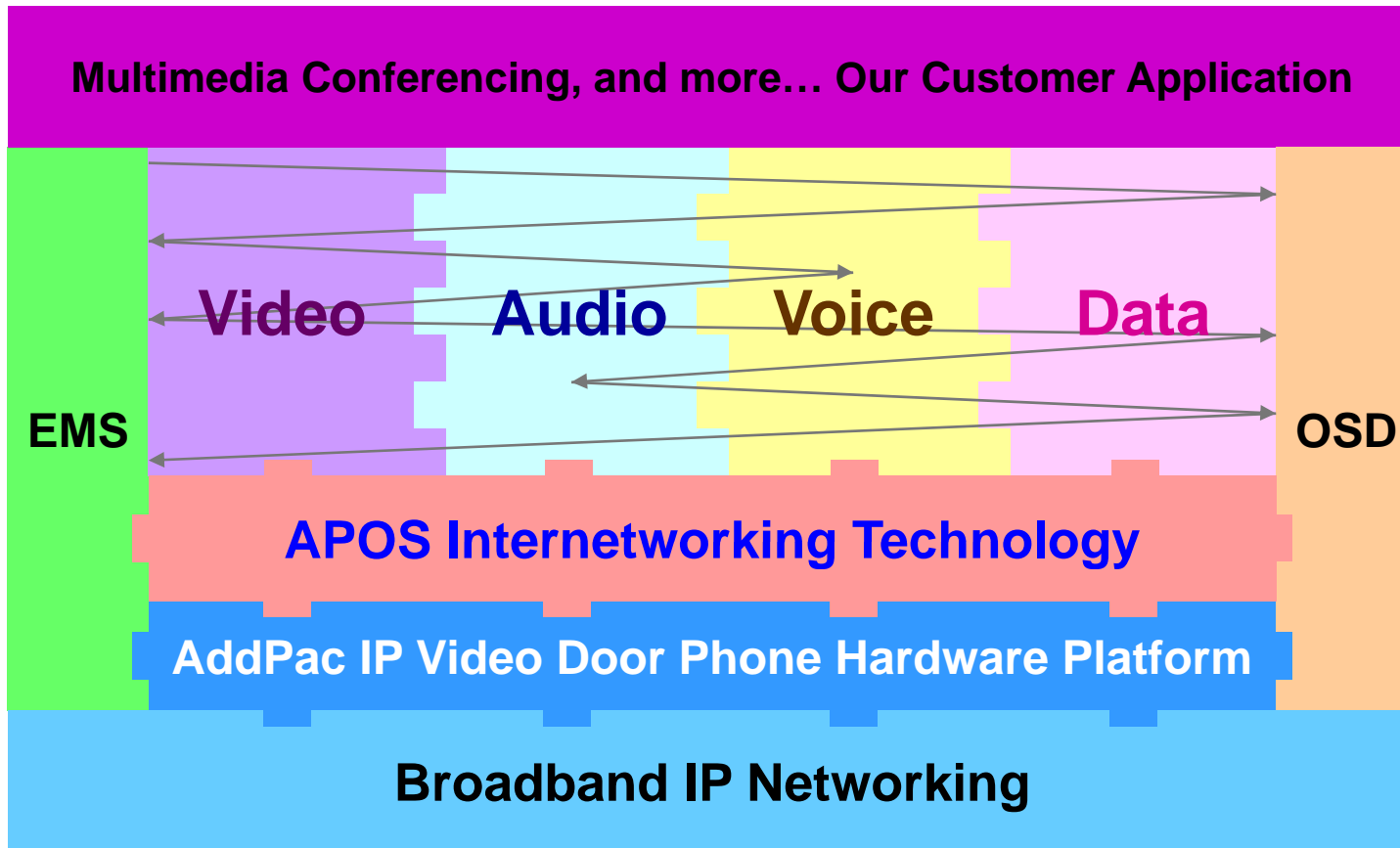

- APOS : AddPac Internetworking Operating System
- OSD : On- Screen Display
- EMS : Element Management System

# Hardware Specification

## AP-VAC150 Fingerprint Recognition IP Video Door Phone

RISC  
CPU

High-end  
DSP

- RISC+DSP Microprocessor Computing Power
- Audio and Voice Interface
  - Internal MIC
  - Internal Speaker
- Video Camera Interface
- Touch Screen TFT Color LCD Interface
  - 5 Inch LCD, 800 x 480 Video Resolution
- Network Interface
  - One(1) 10/100Mbps Fast Ethernet
- Fingerprint Recognition Interface
- RF Card Interface
- Alarm & Relay Out Interface (door open, etc)
- RS232/RS485 Interface
- Power Supply
  - Power over Ethernet (Option)
  - External Power Supply

# Hardware Specification

## AP-VAC150 Fingerprint Recognition IP Video Door Phone

RISC  
CPU

High-end  
DSP

- **Acoustic Echo Canceller**
  - Full-duplex operation during double-talk situations
  - One channel AEC, one channel LEC up to 256ms shared
  - Cancels echoes with up to 10dB echo return
  - Advanced noise reduction(up to 20dB)
- **Speaker**
  - Impedance : 8 +/-15%ohm at 1kHz, 1.0 Vrms
  - Sound Pressure : 90 +/- 3dB at 0.1W/10 CM  
at 800Hz, 1.0kHz, 1.2kHz, 1.5kHz
  - Resonance Level : 550Hz +/- 20%Hz at Fo Hz, 1.0Vrms
  - Frequency Range : Fo Hz ~20kHz
  - Input Power : Normal : 1.0 W, Max : 2.0W
- **Audio Amplifier**
  - 1-W BTL Output(5V, 0.11 % THD+N)
  - Uncompensated Gains of 2 to 20 (BTL Mode)
  - Thermal and Shot-circuit Protection
  - High Supply Ripple Rejection Ratio
- **PoE(Power over Ethernet)**
  - IEEE802.3af compliant
  - Input voltage range 36V to 57V
  - Short-circuit Protection

# Hardware Specification

AP-VAC150 Fingerprint Recognition IP Video Door Phone

RISC  
CPU

High-end  
DSP

- **LCD Controller**
  - One-Chip Solution for TFT-LCD
  - Hardware On-Screen Display (OSD)
  - Support resolution up to 240xRGBx320
  - Up to 24-bit RGB888 Digital Interface
  - Resize Function ( x 1/16, x8)
  - BT.60/BT.66 Digital YCbCr 4:2:2(8-/16-bit) Interface
- **Camera**
  - High Sensitivity for low-light operation
  - Output support for Raw RGB, RGB, and YCrCb format
  - Image Size : VGA, QVGA, and any size scaling down from CIF to 40x30
  - Support AEC, AGC,AWB, ABF, ABLC
  - Saturation Level, Edge Enhancement Level, De-noise level Auto adjust



# Hardware Specification

## AP-VAC150 Fingerprint Recognition IP Video Door Phone

RISC  
CPU

High-end  
DSP

- RF Card Sensor
  - Protocol Supported
    - ISO14443A/B all bit rates
      - > 106,212,424 and 848 kbps
    - Compatible to MiFare Classic
    - ISO15693 all modes
      - > 1.65/6.6 & 26.5 kbps
      - > Uplink 1 & 2 sub-carrier
  - Receiver
    - Rx Sensitivity down to 1mVrms
    - Rx Automatic Gain Control
    - Accept external baseband signal from external circuitry for frame level processing
    - Integrated signal strength indicator (SSI)
    - On-Chip Framing handler for supported standard
  - Transmitter
    - Typical proximity operating distance up to 100mm.
    - Software configurable modulation index
    - Maximum driving current up to 200 mA/PIN @ 5V
    - Accept external baseband signal for RF modulation
    - Wide Transmitter driver supply range from 2.7~7.0V

# Hardware Specification

AP-VAC150 Fingerprint Recognition IP Video Door Phone

RISC  
CPU

High-end  
DSP

- Fingerprint Recognition
  - Sensor Type : Capacitive
  - Resolution(dpi) : 508
  - Sensing Area(mm) : 12.8 x18.0
  - Image Size(pixel) : 256 x 360
  - CPU : 400MHz DSP
  - Flash Memory : 4MB
  - ERR : < 0.1%
  - Enrollment Time : 800msec
  - 1:1 Verification Time : 800msec
  - 1:1000 Identification Time : 970msec
  - Template Size : 256~384bytes (configurable, 384bytes default)
  - Template Capacity : 9,000
  - Encryption : 256bit AES



Fingerprint Recognition

# Hardware Specification

AP-VAC150 Fingerprint Recognition IP Video Door Phone

RISC  
CPU

High-end  
DSP

## Front Side



# Hardware Specification

AP-VAC150 Fingerprint Recognition IP Video Door Phone

RISC  
CPU

High-end  
DSP

## Back Side

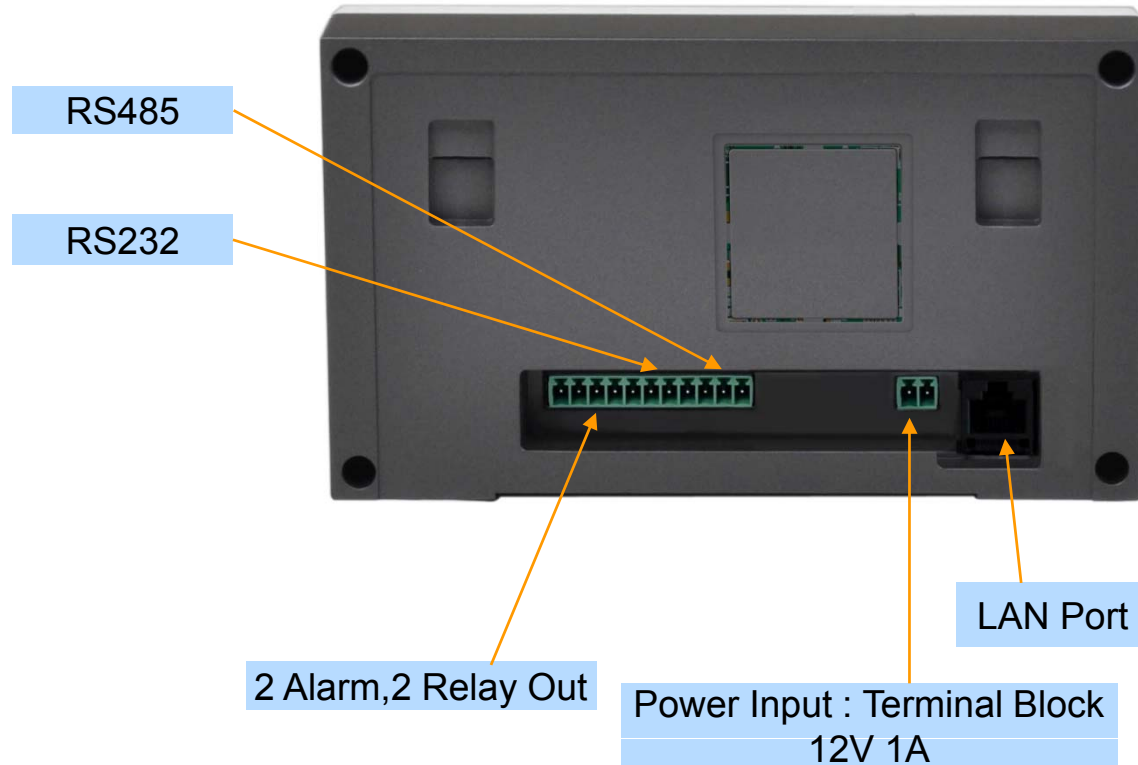

# Hardware Specification

AP-VAC150 Fingerprint Recognition IP Video Door Phone

RISC  
CPU

High-end  
DSP

## Power Supply

Terminal Block



12V 1A Power Adaptor

Example



# Software Service

AP-VAC150 Fingerprint Recognition IP Video Door Phone

- **Built-in AddPac APOS Internetworking Software**
  - Scalability, Functionality, and Stability Features
  - Video Traffic QoS Control
- **Programmable Video, Audio, and Voice Services**
  - Video Codes, Audio, and Voice Codec
- **Firmware Upgradeable DSP Architecture**
- **OSD (On-screen Display) Function Support**
- **Industry Standard IP based Network Protocol Features**

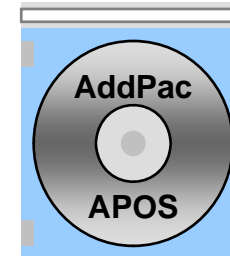

# Video Service and Features

## AP-VAC150 IP Video Door Phone

- **High-performance Video Codec Support**
  - H.264, etc
- **Image Resolution Support**
  - Local Display : 160 x 120
  - Remote Display : 240 x 160
  - Video Encoding : VGA(640x480), QVGA(320x240)
- **Up to 30fps with VGA Resolution**
- **128Kbps to 2Mbps Operating Video Traffic Bandwidth**
- **Rate Control for Video Traffic QoS**
  - Ensuring Optimized Quality
  - Frame Rate with Limited Bandwidth
- **High-end Error Resilient Against Various Packet Error**

# Audio & Voice Service and Features

AP-VAC150 Fingerprint Recognition IP Video Door Phone

- **VoIP based Signaling Protocol Support**
  - SIP Signaling Protocol Stack
- **High-performance Audio & Voice Codec Support**
  - G.711, G.726 Audio Codec
- **Enhanced QoS Management Features for Voice Traffics**





# Smart Web Manager (Example)

# Smart Web Manager

AP-VAC150 Fingerprint Recognition IP Video Door Phone

- Main Screen
- System
  - Language
  - LAN Setup
  - DACS
  - Display
  - File Browser
- SIP Call & Media
  - SIP (Session Initiation Protocol)
  - Speed Dial
  - Media
- Miscellaneous
  - Door Control and Test
  - Network Test

# Smart Web Manager : Main Screen

AP-VAC150 Fingerprint Recognition IP Video Door Phone

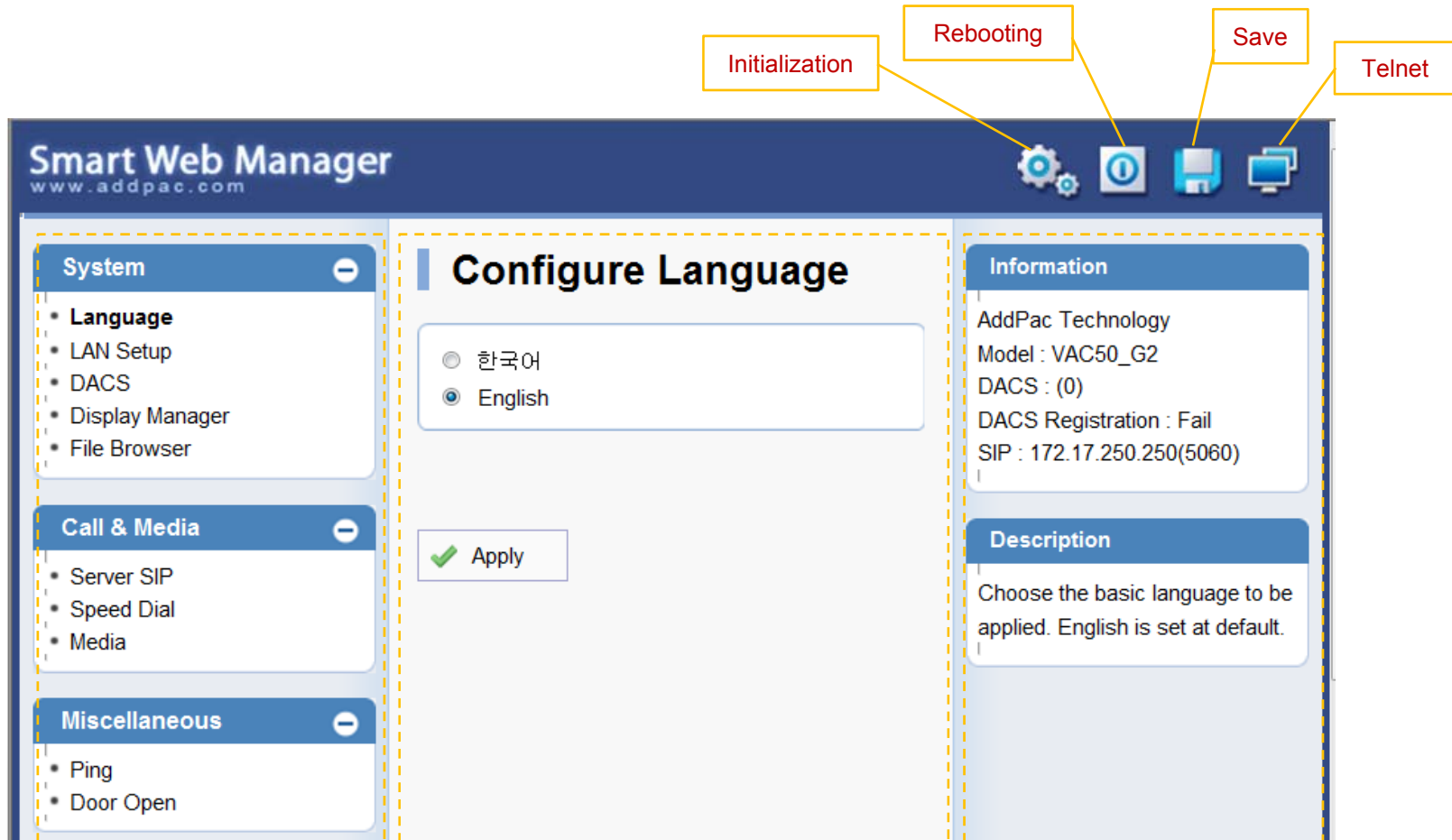

Menu Tree

Output Screen after  
Menu Select

System Information and  
Help Message

# Smart Web Manager : SIP configuration

AP-VAC150 Fingerprint Recognition IP Video Door Phone

## SIP (Session Initiation Protocol)

SIP server check if exist.

Use SIP Server  Yes  No

SIP Basic Information Display

Primary SIP Server

172.17.250.250 5060 Server address and Port (default 5060)

Secondary SIP Server

5060 Server address and Port (default 5060)

Local Domain Name

(SIP userpart of authentication)

SIP Signaling Port

5060 (default 5060, between 1 to 65535)

Register Expiration

60 (in seconds, default 60, between 10 to 86400)

Session Re-Fresh

INVITE  UPDATE

Session Expire Time

1800 (in seconds, default 1800, between 30 to 86400, 0 = disable)

Min-SE

1800 (in seconds, default 1800, between 30 to 86400)

Extension

1020 Extension Number, Password

Telephone Line Number and Password Configuration Same Information is used when DACS is connected

# AP-VAC150 IP Video Door Phone

## Application Area

- Point-to-Point Application (Simple Application)
- Point-to-Multipoint Application
  - All AddPac Solution  
(Call Manager + Door Access Control Server)
  - Legacy PBX Environment
  - Legacy IP-PBX Environment

# Point-to-Point Connection (Simple Appl.)

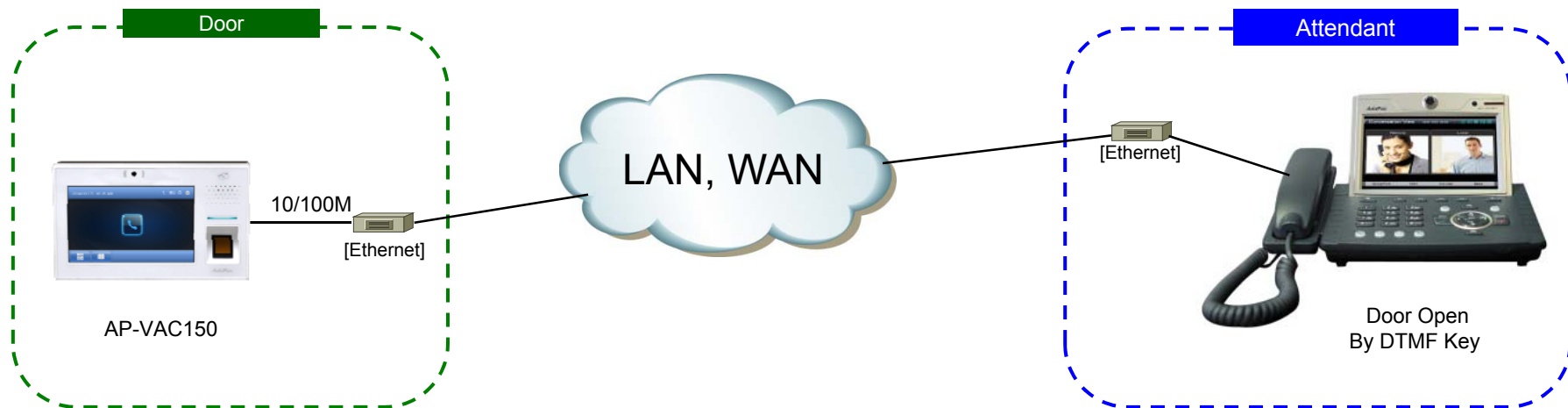

# Integrated Door Access Control and Call Control (All AddPac Solution)

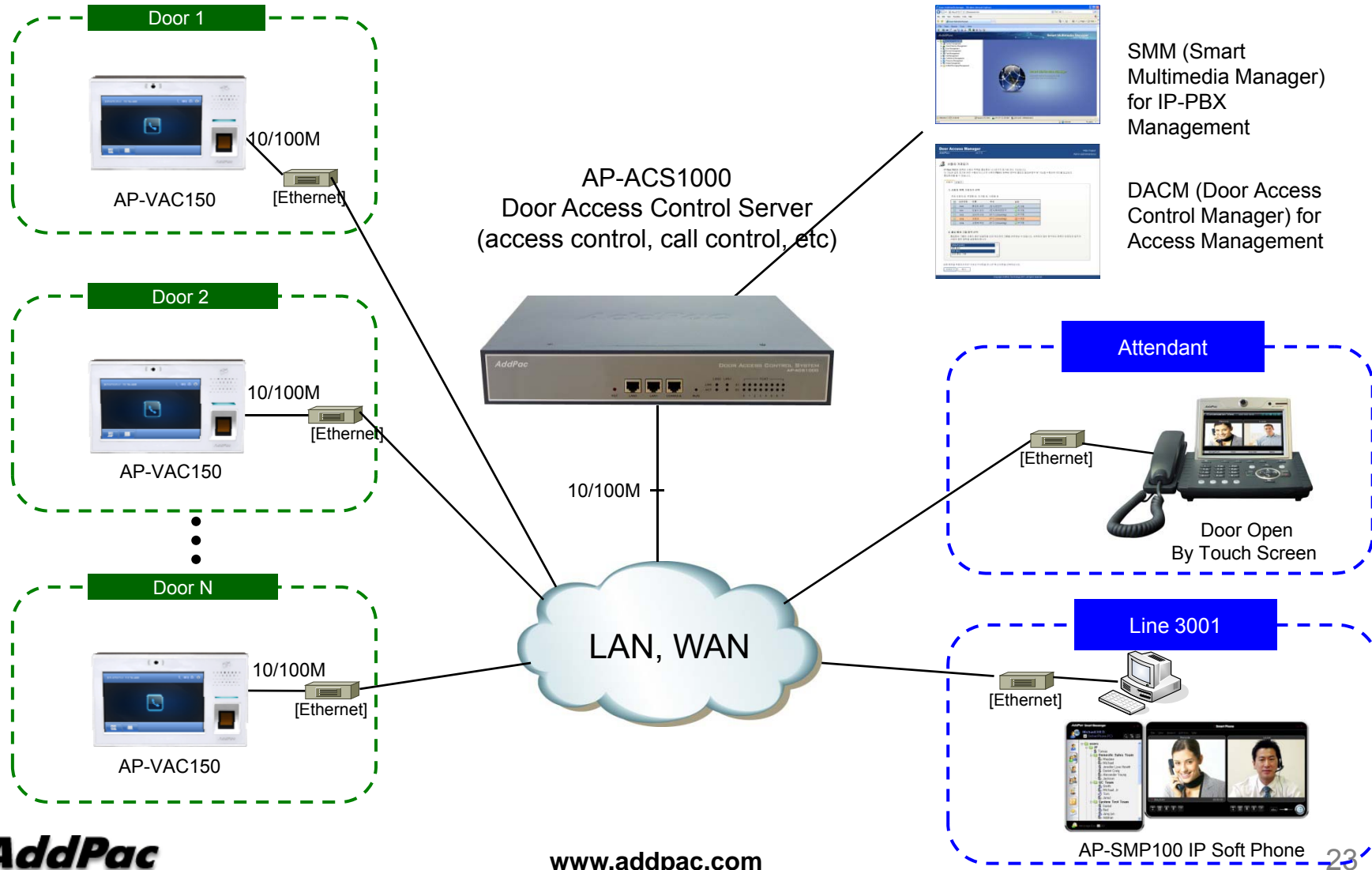

# Legacy PBX Environment

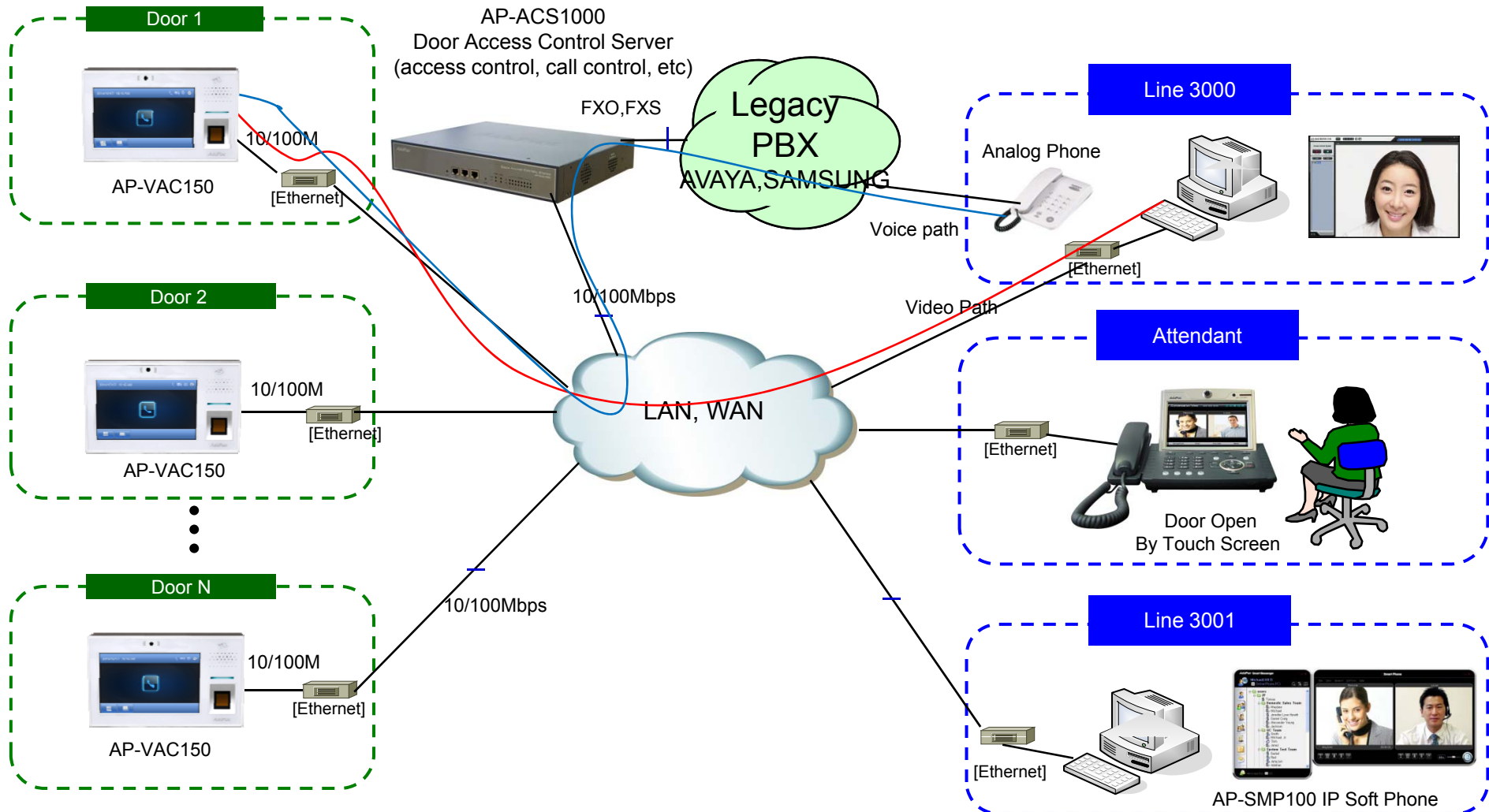



# Legacy IP-PBX Environment

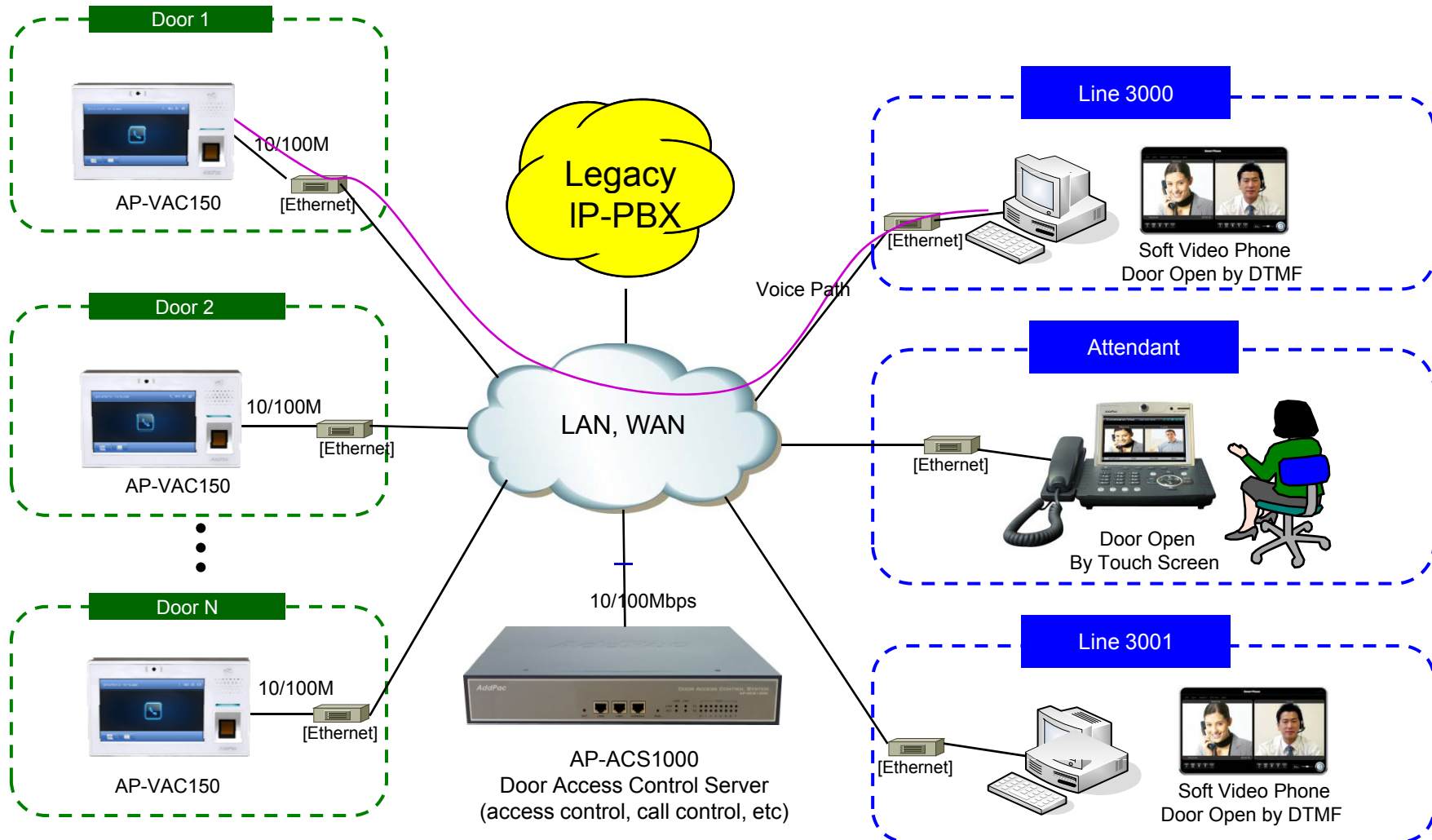

# Ordering Information

- **AP-VAC150 IP Video Door Phone Hardware**
  - AP-VAC150 Video Phone Main Body
  - RISC Microprocessor with High-end Programmable DSP Architecture
  - 5 Inch LCD, Built In Camera, Side Light
  - Fingerprint Recognition, RF card Interface
  - Internal MIC, Internal Speaker
  - 1-ports 10/100Mbps Fast Ethernet
  - PoE Interface
  - Optional WiFi Interface (USB Type)
  - Including Network Cable Set & Ext. Power Supply, etc.
- **Built-in APOS Internetworking Software for AP-VAC150**
- **Including 1 Year Hardware Warranty**
- **Product Documents**
  - Install and Operation Guide (PDF)
- **Pricing**
  - AddPac Technology Regional Sales Manager
  - Authorized Sales and Marketing Representatives
  - Please Contact [www.addpac.com](http://www.addpac.com)



# Thank you!

**AddPac Technology Co., Ltd.**  
Sales and Marketing

Phone +82.2.568.3848 (KOREA)

FAX +82.2.568.3847 (KOREA)

E-mail [sales@addpac.com](mailto:sales@addpac.com)