

AddPac IP Video Door Phone Solution

Access Control Server Redundancy
Scheme for High Reliability IP Video
Door Phone Service



AddPac

AddPac Technology

2014, Sales and Marketing

Contents

- General IP Video Door Phone Service Network Diagram
- Access Control Server Redundancy Scheme
- Access Control Server Overview
 - AP-ACS1000 Door Access Control Server (Example)

General IP Video Door Phone Service Network Diagram

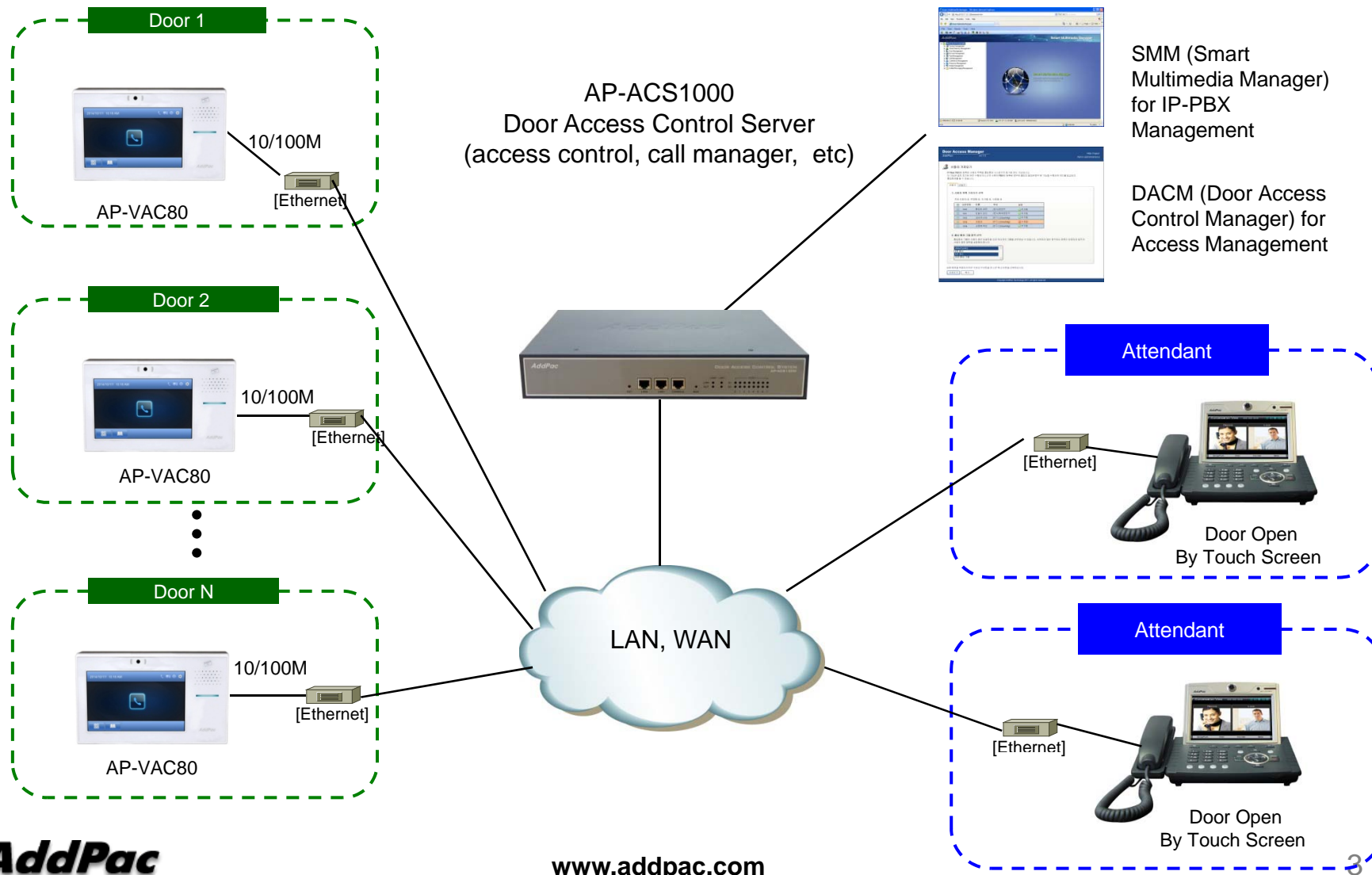



Access Control Server Redundancy Scheme

ACS Network Diagram

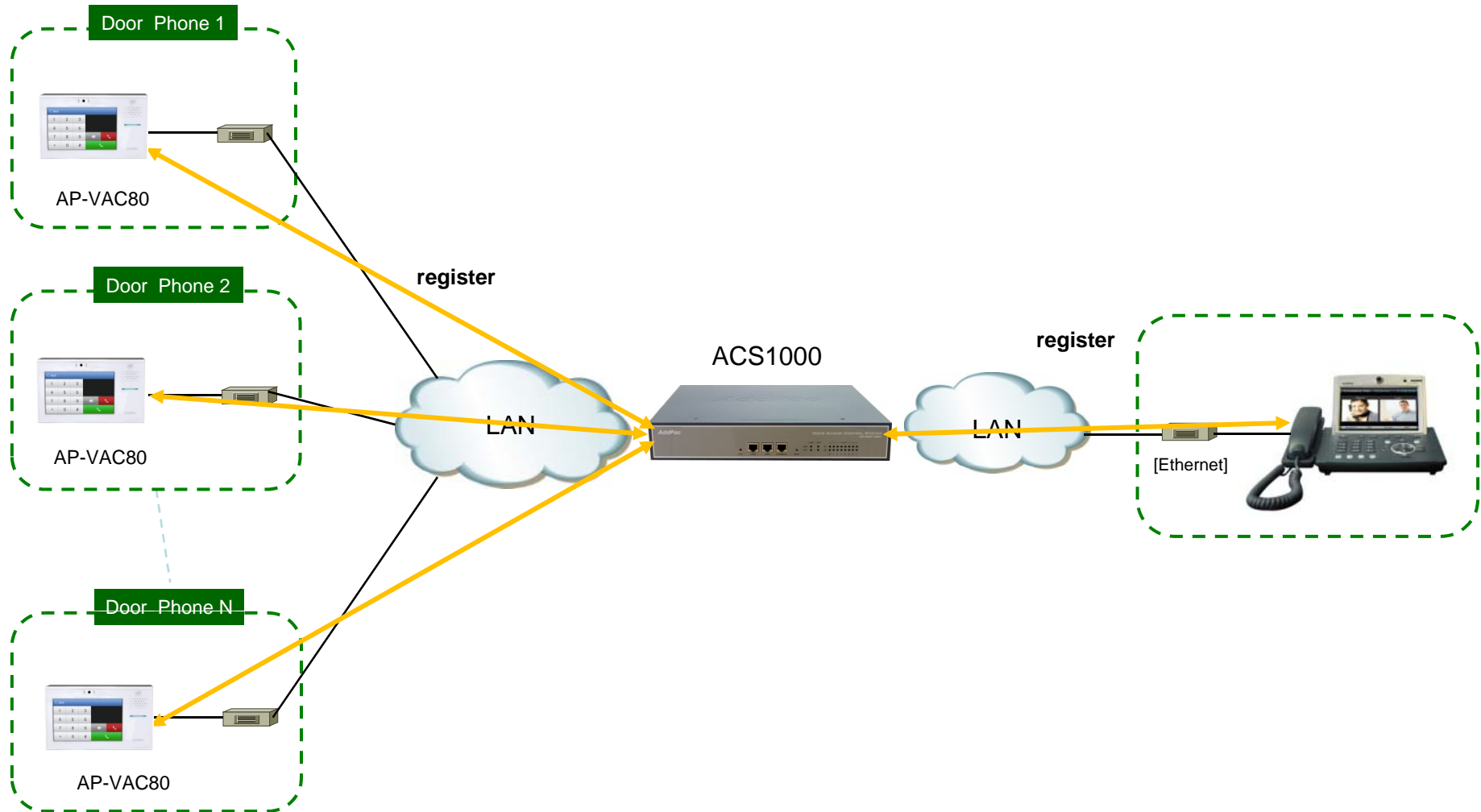

ACS Redundancy Scheme Network Diagram

- Call Manager Function

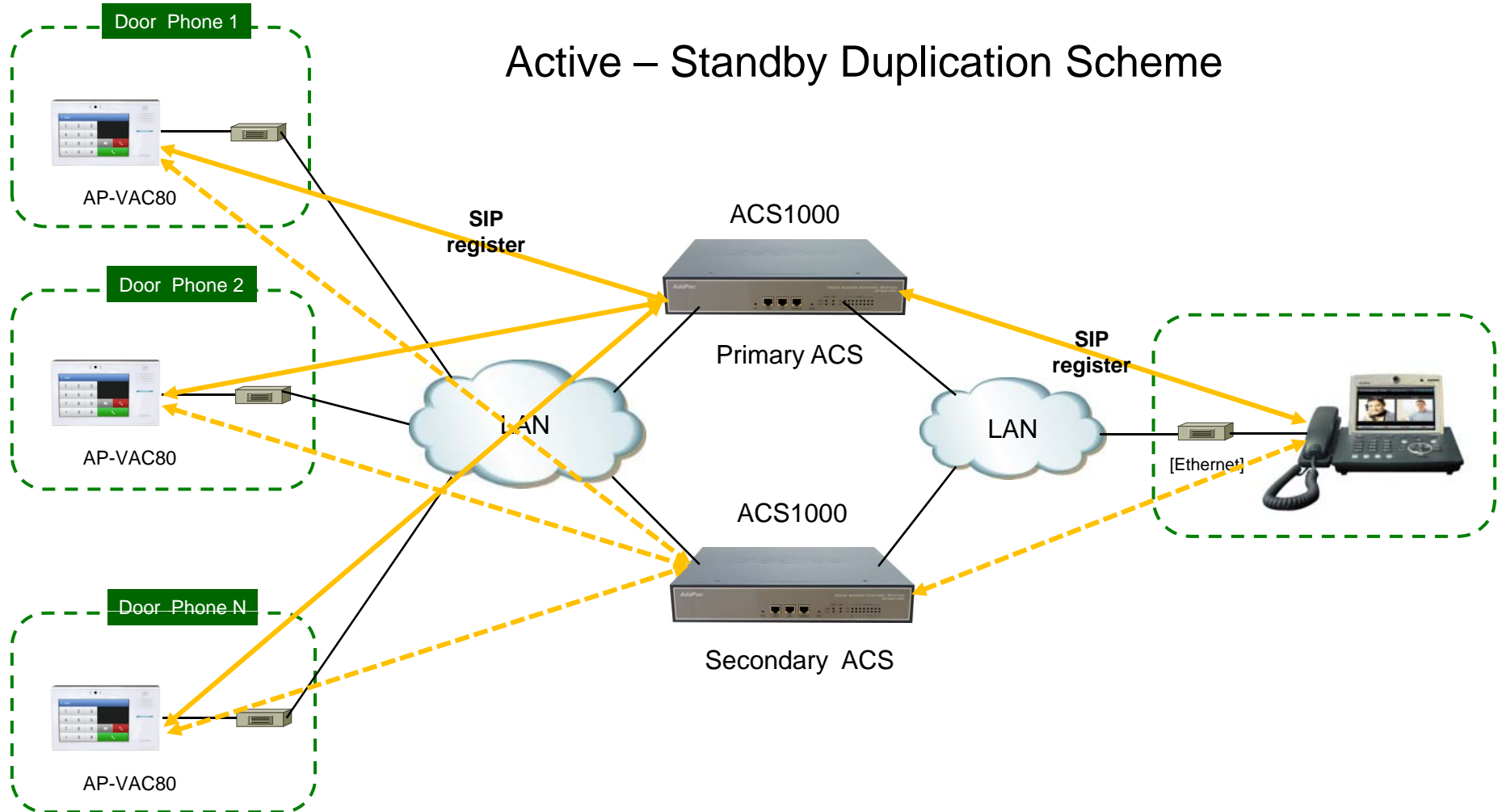

ACS Redundancy Scheme Network Diagram

- Door Access Control Function

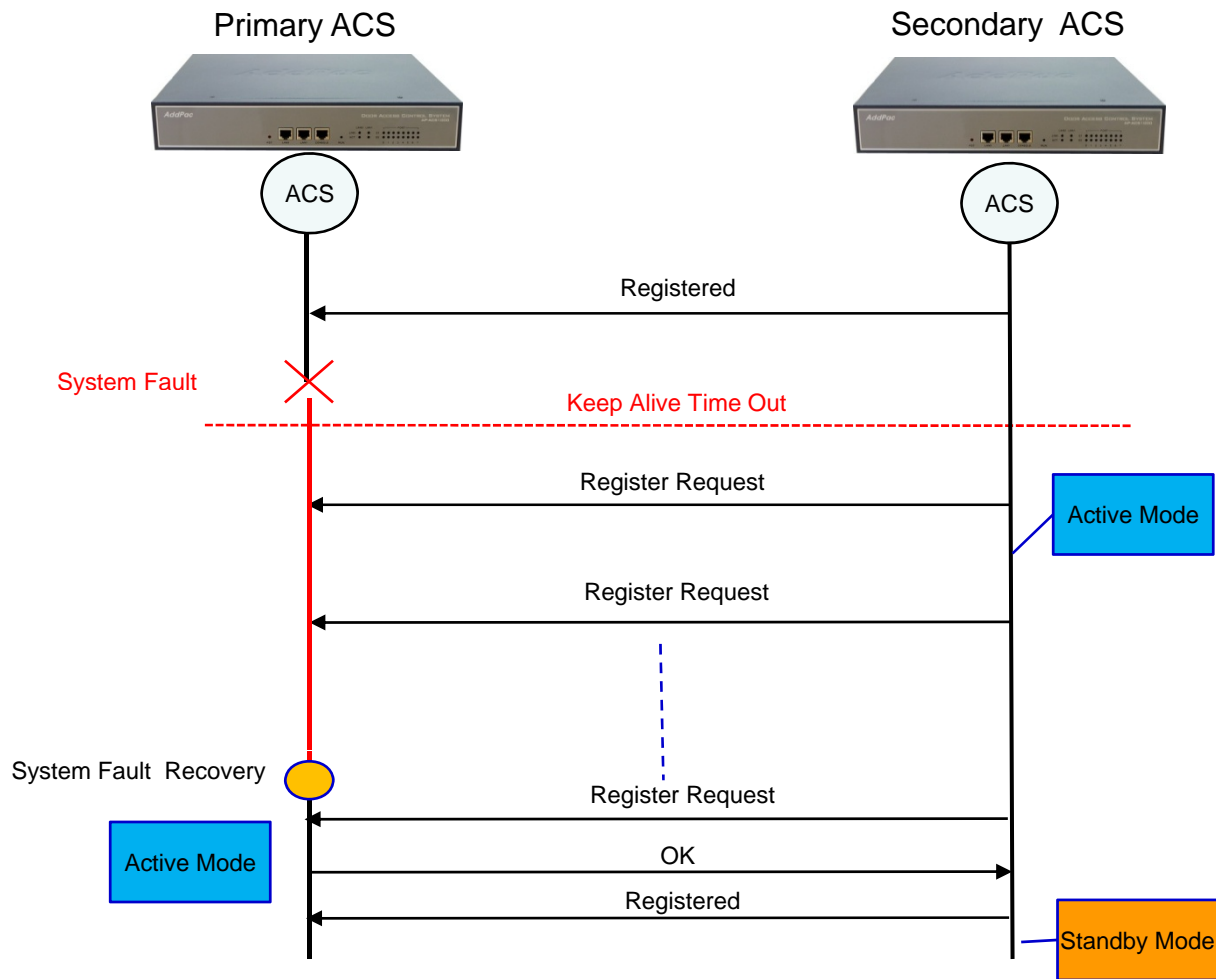



Access Control Server Overview

Example : AP-ACS1000

Main Features

AP-ACS1000 DACS (Door Access Control System)

- Door Access Control Application System
- SIP Application Server, Proxy, Registrar and Location Server
- Multiple ITSP Trunk with SIP & H.323 Accounts Support
- Legacy PBX Interworking Service
- High Performance RISC & Programmable DSP Architecture
- Two(2) 10/100Mbps Fast Ethernet (IP Share ,etc)
- High Performance LAN-to-LAN Routing Capability
- Powerful Network Protocols (PPPoE, DHCP, Static Routing, etc)
- IPv4/IPv6 Dual Stack
- Firmware Upgradeable Architecture
- Smart Multimedia Manager for IP-PBX Management
- DACM(Door Access Control Manager)
- Advanced Voice QoS Mechanism
- Small, Light and Compact Design
- Two(2) VoIP Module Slots for Analog, Digital Interface

Main Features

AP-ACS1000 DACS (Door Access Control System)

- RISC Microprocessor Computing Power
- Main Chassis
 - Network Interface
 - Two(2) 10/100Mbps Fast Ethernet
 - One(1) RS-232C Console (RJ45)
 - Two(2) VoIP Module Slots for FXS, FXO etc



Hardware Specification

AP-ACS1000 DACS (Door Access Control System)

AP-ACS1000 Front Side



LAN1 (10/100Mbps)

LAN0(10/100Mbps)

Console Port

www.addpac.com

Hardware Specification

AP-ACS1000 DACS (Door Access Control System)

AP-ACS1000 Back Side



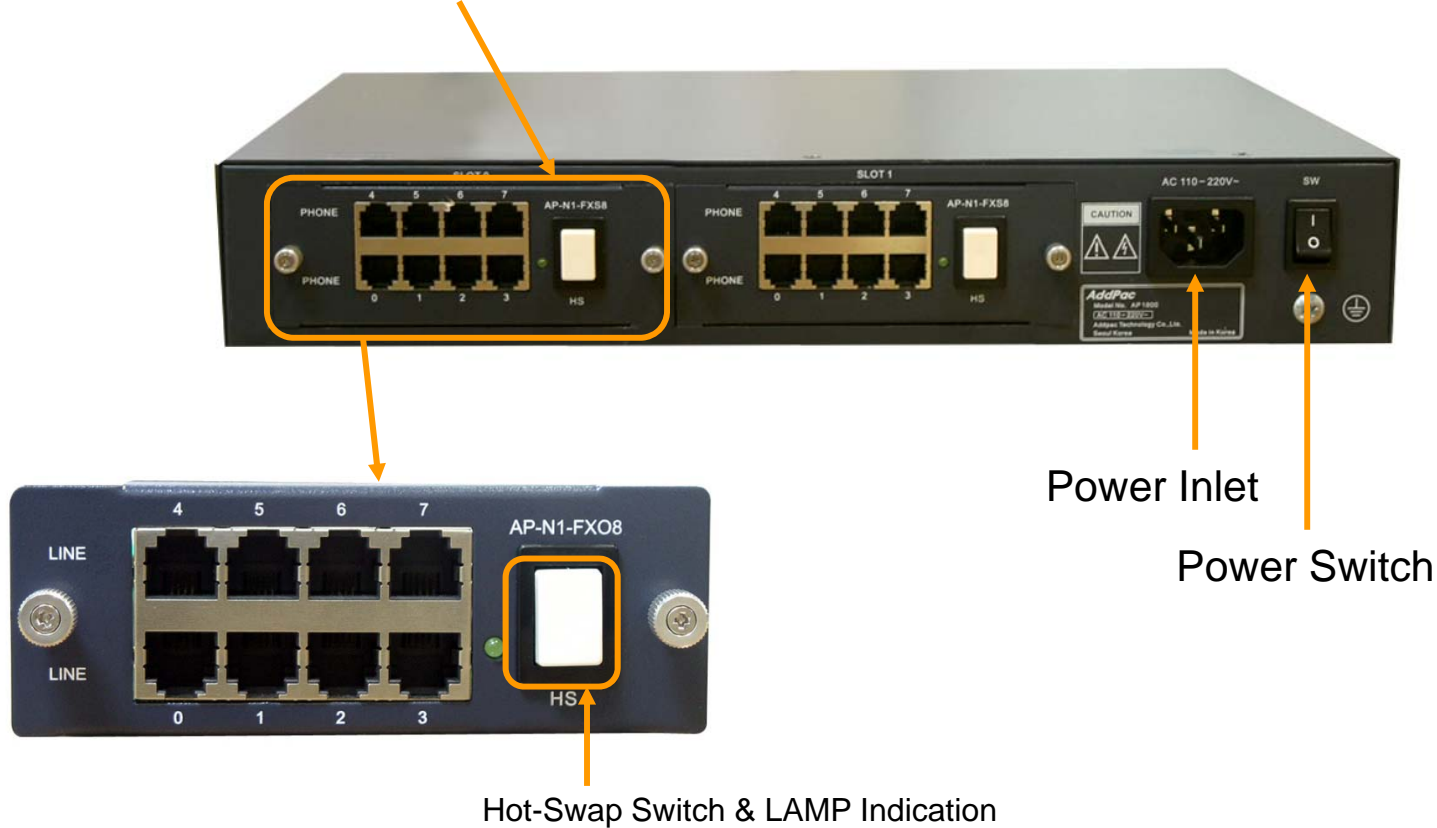

PSTN Interface Module



Hardware Specification

AP-ACS1000 DACS (Door Access Control System)

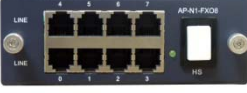
PSTN Interface Module

AP-N1-FXS8	 A black 8-port FXS voice processing module with RJ11 ports numbered 0-7 and a central switch labeled 'HS'.	8-Port FXS Voice Processing Module (8 x RJ11)
AP-N1-FXO8	 A black 8-port FXO voice processing module with RJ11 ports numbered 0-7 and a central switch labeled 'HS'.	8-Port FXO Voice Processing Module (8 x RJ11)
AP-N1-FXO4S4	 A black 8-port voice processing module with 4 FXO and 4 FXS ports, numbered 0-7, and a central switch labeled 'HS'.	4-Port FXO and 4-Port FXS Voice Processing Module (8 x RJ11)
AP-N1-E1T1	 A black 1-port VoIP digital E1/T1 interface module with an RJ45 port and a central switch labeled 'HS'.	1-Port VoIP Digital E1/T1 Interface Module(1xRJ45)



DACS System Message Flow

DACS System Message Flow

Registration and KeepAlive

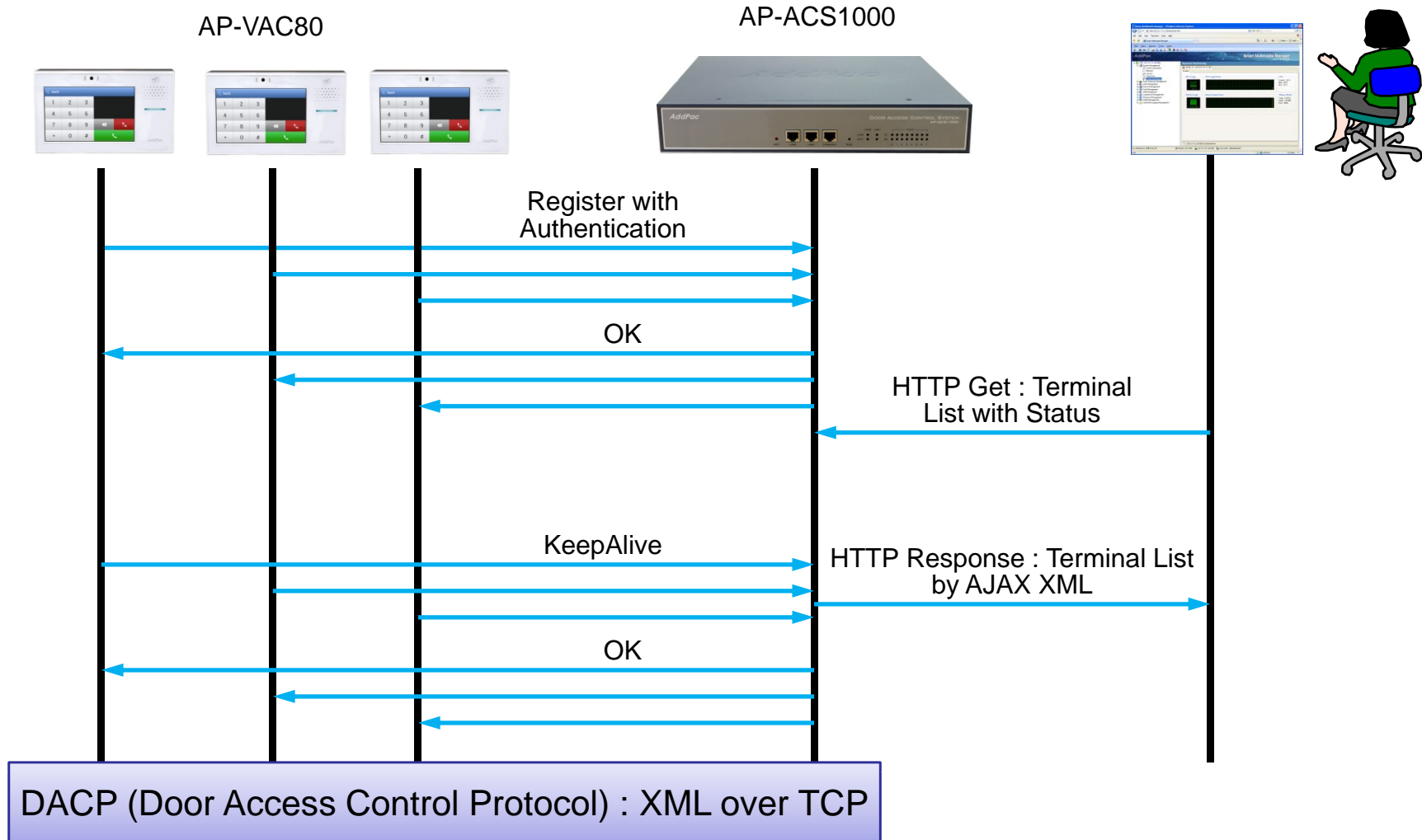

DACS System Message Flow

Access Privilege and Schedule Download

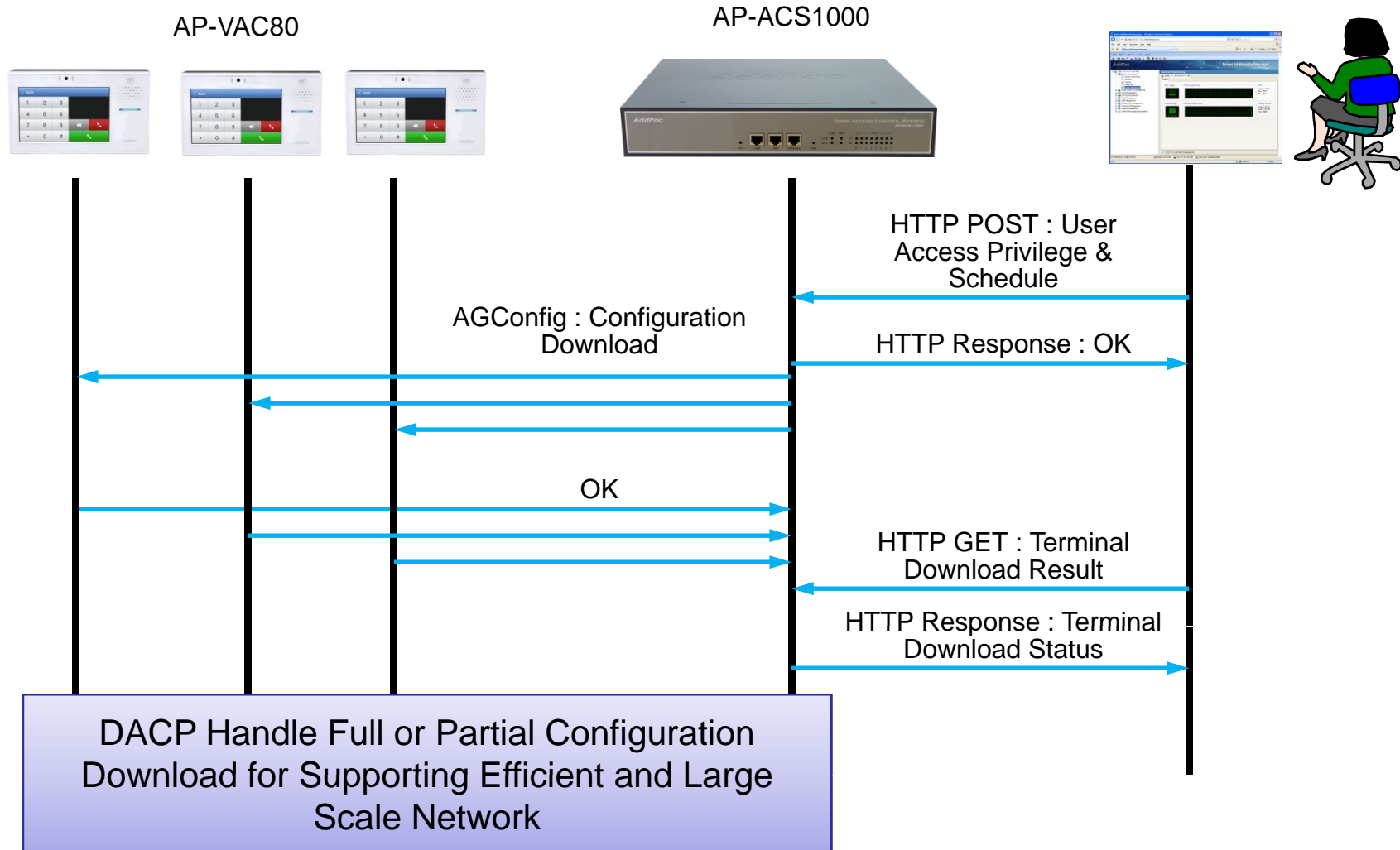

DACS System Message Flow

RF Card Read/Write and Registration

AP-VAC80



AP-ACS1000

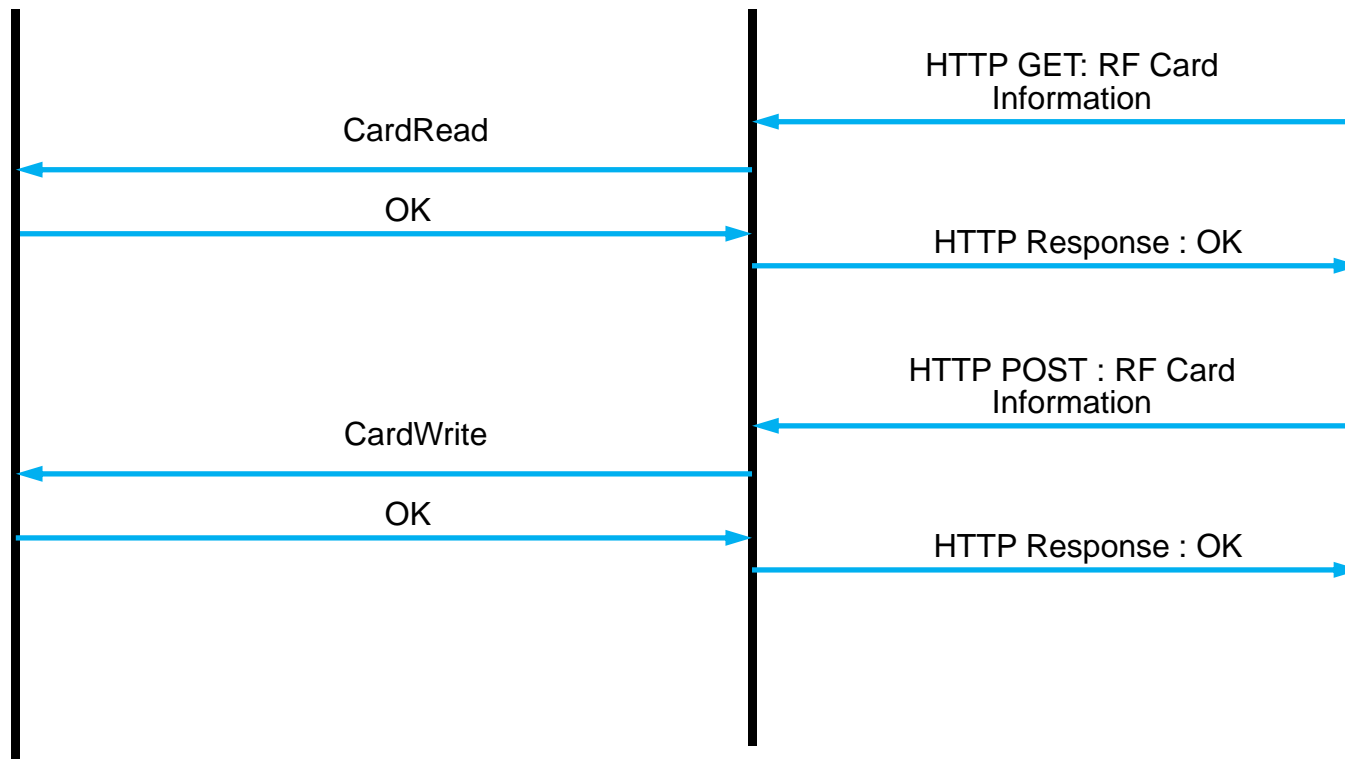
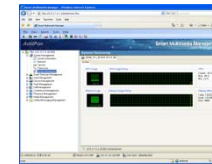

DACS System Message Flow

Door Open by RF Card or Password

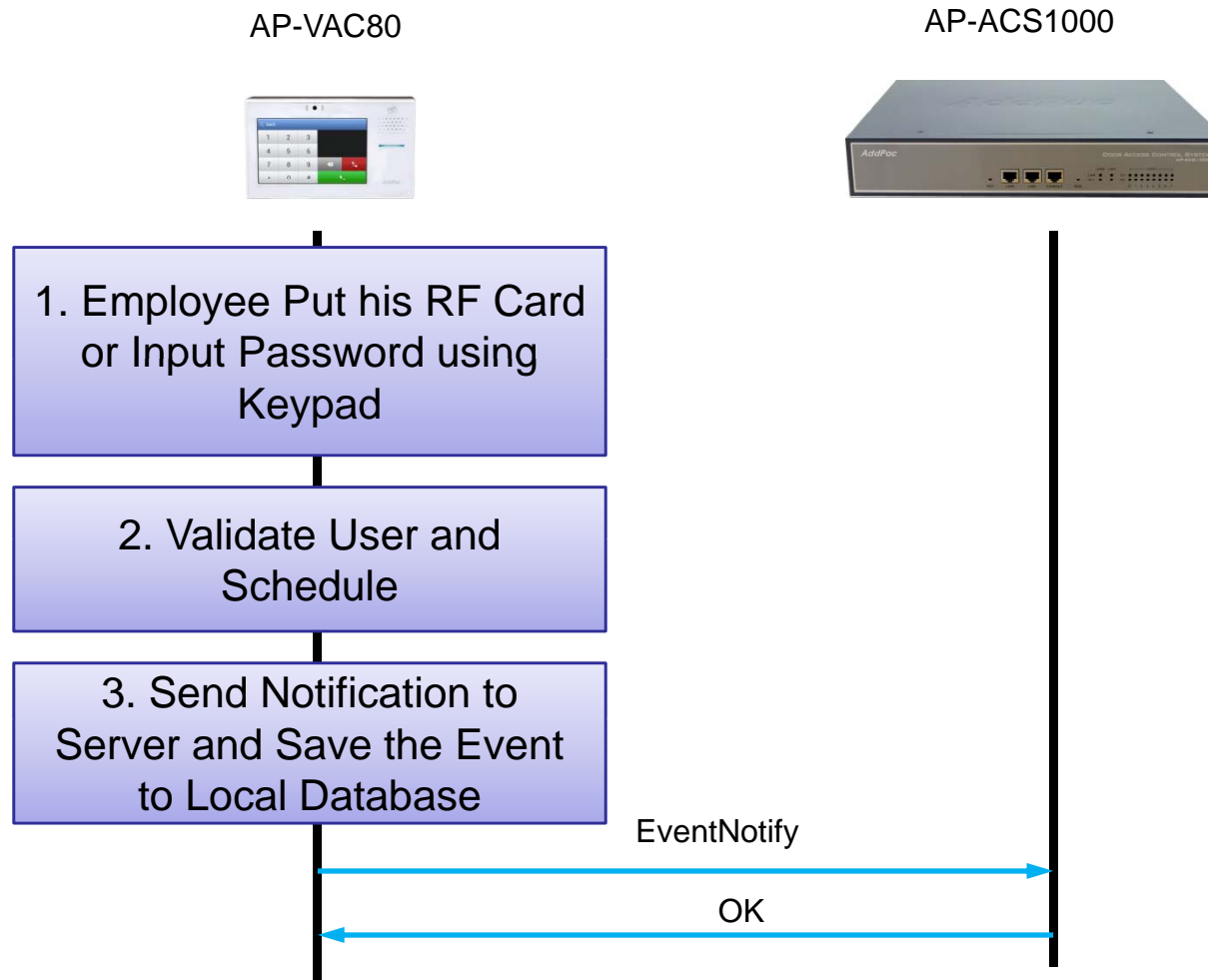

DACS System Message Flow

Door Open by Other Terminal

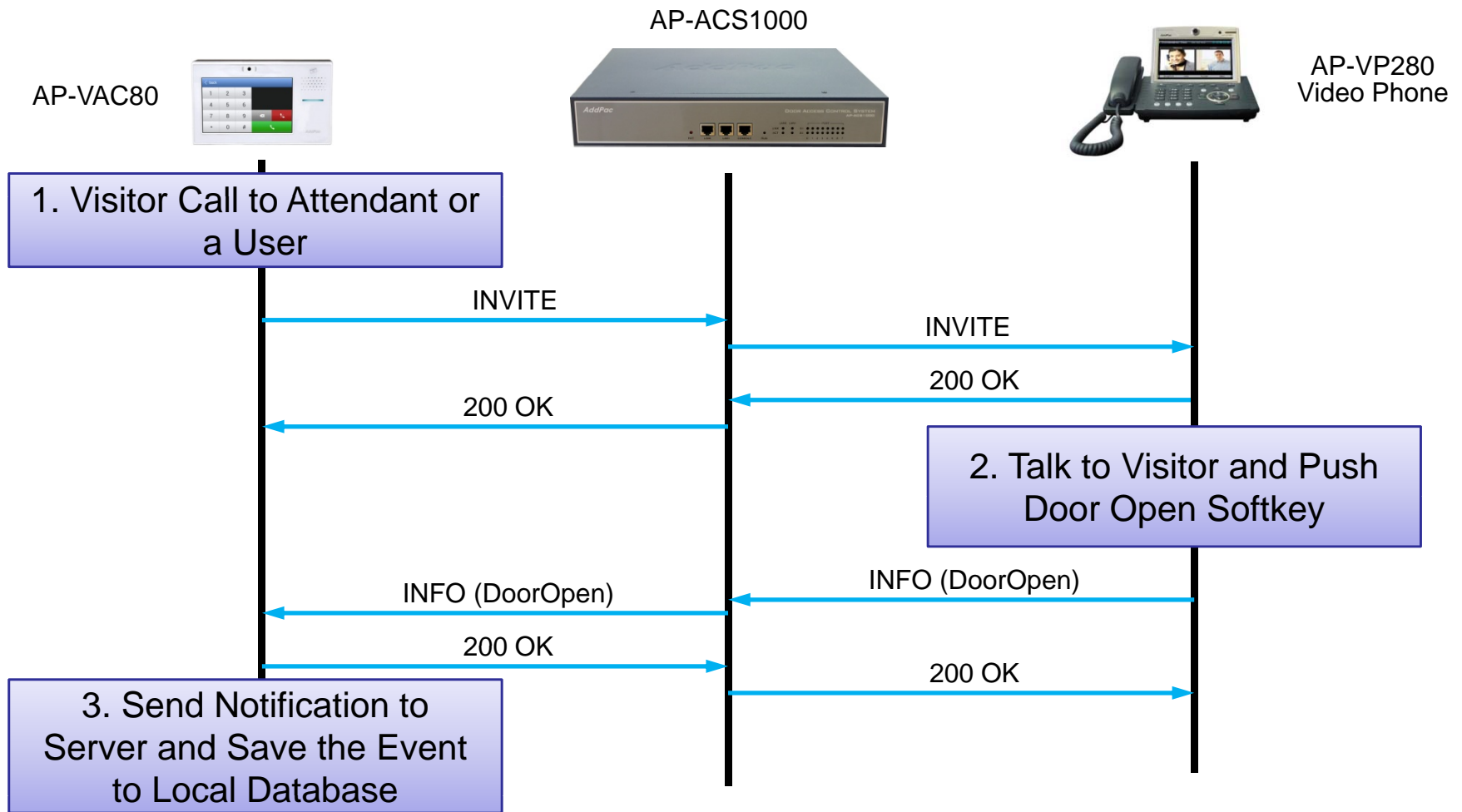



Door Access Control Manager for AP-ACS1000

DACM (Door Access Control Manager)

Main Web Page

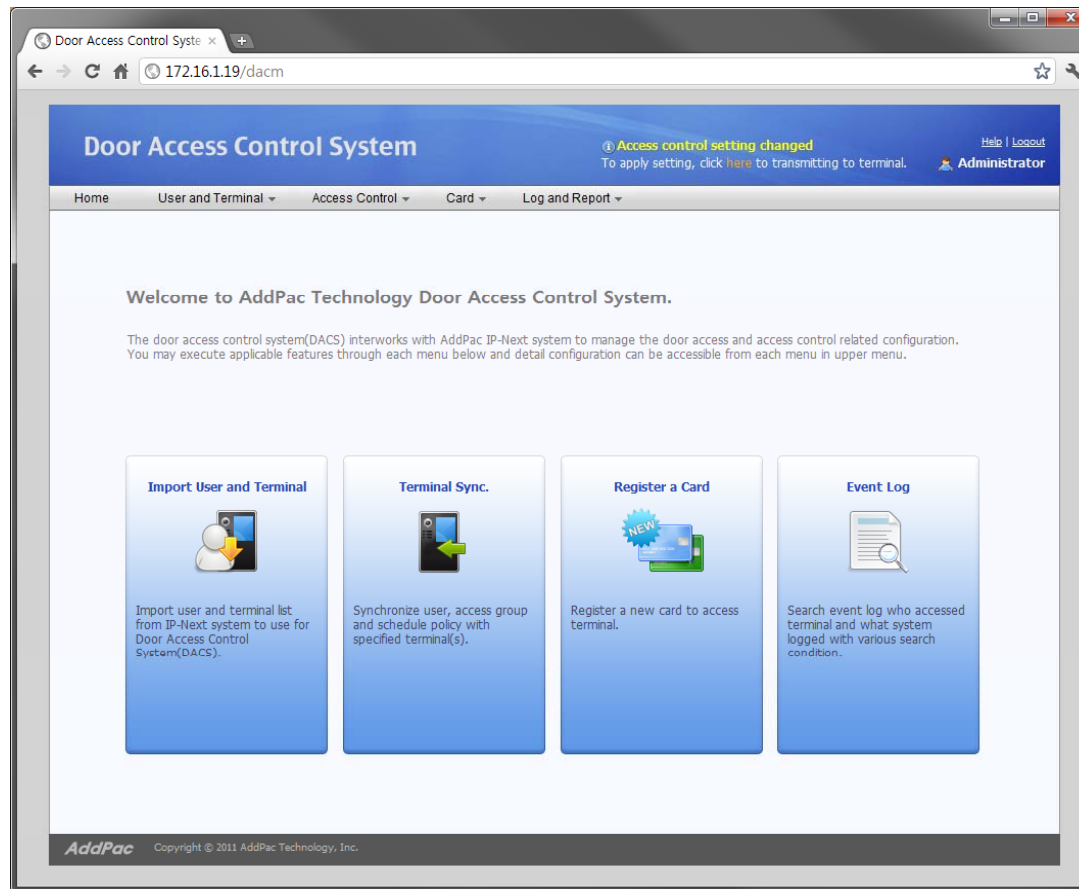

DACM (Door Access Control Manager)

Import User and Terminal

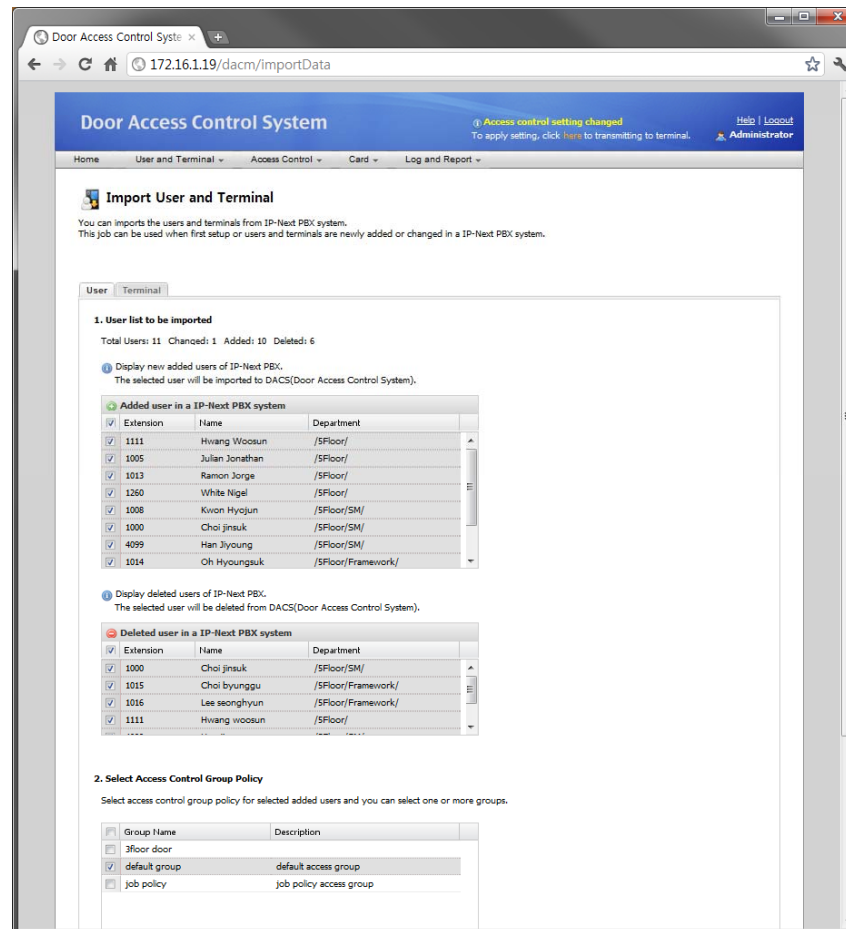

DACM (Door Access Control Manager)

User List

Door Access Control System

Access control setting changed
To apply setting, click [here](#) to transmitting to terminal.

Help | Logout
Administrator

Home User and Terminal Access Control Card Log and Report

User List

Search registered access terminal user or search for all users. You can proceed add/change/delete through the screen.

Search List: All Users Input search word Search Import User

	Extension	Name	Department	Access Policy	Date Created	Modify	Delete
1	1000	Choi jinsuk	/SFloor/SM/	Access Allow	2011-07-22 15:50:01		
2	1008	Kwon hyojun	/SFloor/SM/	Access Allow	2011-07-22 15:50:00		
3	1014	Oh hyongsuk	/SFloor/Framework/	Access Allow	2011-07-22 15:50:01		
4	1015	Choi byunggu	/SFloor/Framework/	Access Allow	2011-07-22 15:50:01		
5	1016	Lee seonghyun	/SFloor/Framework/	Access Allow	2011-07-22 15:50:01		

Page 1 of 1 Total: 5

AddPac Copyright © 2011 AddPac Technology, Inc.

DACM (Door Access Control Manager)

Terminal List

Door Access Control System

Access control setting changed
To apply setting, click [here](#) to transmitting to terminal.

Help | Logout
Administrator

Home User and Terminal Access Control Card Log and Report

Terminal List

Display the registered door phone lists imported from IP-Next PBX system.

Import Terminal

	Terminal Name	Description	Status	Extension	IP Address	Model Name	Version	Date Created	Detail View
1	2floor door terminal	2Floor door ter...	Connected	1006	172.16.10.4	AP-VAC50		2011-07-29 17:08:50	
2	3floor door terminal	3Floor door ter...	Connected	1002	172.16.10.1	AP-VAC20	8.50.001	2011-07-22 15:50:01	
3	5floor door terminal	5Floor door ter...	Connected	1005	172.16.10.2	AP-VAC50		2011-07-29 17:08:50	
4	The main entrance d...	The main entran...	Connected	Required setting	172.16.10.3	AP-VAC100		2011-07-29 17:08:50	

Page 1 of 1 Total: 4

AddPac Copyright © 2011 AddPac Technology, Inc.

DACM (Door Access Control Manager)

Access Control Group Management

The screenshot displays the web interface for the Door Access Control System. The browser address bar shows the URL `172.16.1.19/dacm/accessGroupList`. The page title is "Door Access Control System". A notification banner at the top right indicates "Access control setting changed" and provides instructions to apply settings. The navigation menu includes "Home", "User and Terminal", "Access Control", "Card", and "Log and Report". The main content area is titled "Access Control Group" and includes a brief description: "You can define a new Access Control Group with one or more terminals, users and schedule policy. Also, you can adjust priority of access control group using up/down arrow (or mouse drag/drop)." Below this is a table listing existing groups, with columns for Group Name, Description, Schedule Policy, Date Created, Modify, and Delete. A button "Add a Access Control Group" is located above the table.

Group Name	Description	Schedule Policy	Date Created	Modify	Delete
3floor door		All Allow	2011-06-28 11:37:13		
job policy	job policy access group	working day	2011-07-04 17:06:47		
default group	default access group	All Allow	2011-06-28 11:37:13		

DACM (Door Access Control Manager)

Configuration Download to Terminal

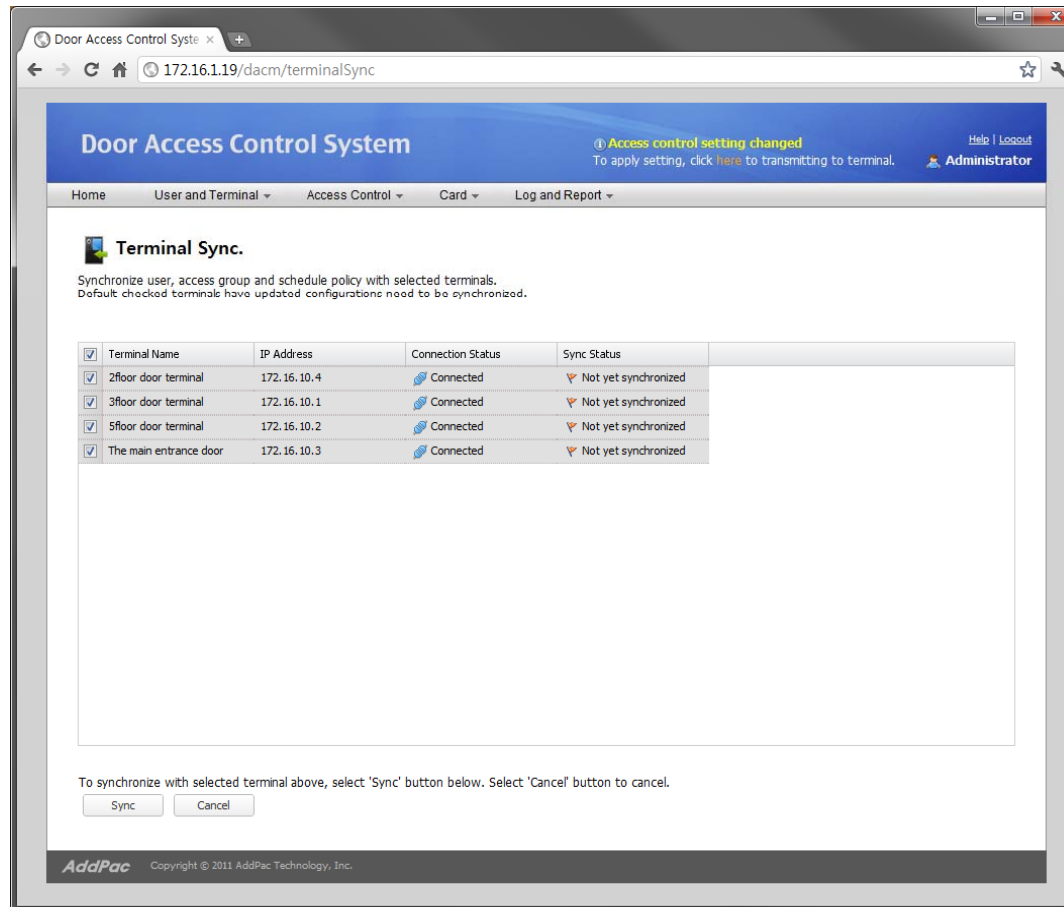

Door Access Control System

Access control setting changed
To apply setting, click [here](#) to transmitting to terminal.

Help | Logout
Administrator

Home User and Terminal Access Control Card Log and Report

Terminal Sync.

Synchronize user, access group and schedule policy with selected terminals.
Default checked terminals have updated configurations need to be synchronized.

<input checked="" type="checkbox"/>	Terminal Name	IP Address	Connection Status	Sync Status
<input checked="" type="checkbox"/>	2floor door terminal	172.16.10.4	Connected	Not yet synchronized
<input checked="" type="checkbox"/>	3floor door terminal	172.16.10.1	Connected	Not yet synchronized
<input checked="" type="checkbox"/>	5floor door terminal	172.16.10.2	Connected	Not yet synchronized
<input checked="" type="checkbox"/>	The main entrance door	172.16.10.3	Connected	Not yet synchronized

To synchronize with selected terminal above, select 'Sync' button below. Select 'Cancel' button to cancel.

AddPac Copyright © 2011 AddPac Technology, Inc.

DACM (Door Access Control Manager)

RF Card Management

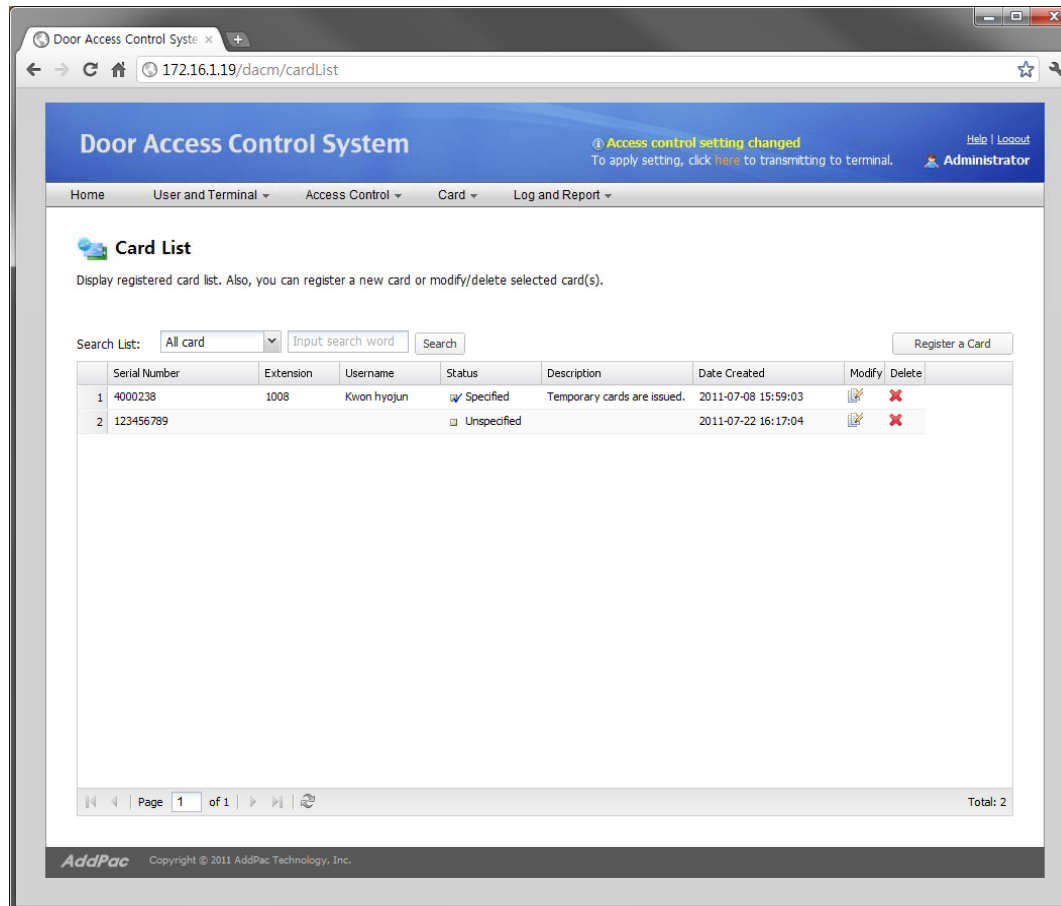

The screenshot displays the 'Door Access Control System' web interface. The browser address bar shows '172.16.1.19/dacm/cardList'. The page title is 'Door Access Control System'. A notification banner at the top right states 'Access control setting changed' with a link to 'To apply setting, click here to transmitting to terminal.' and a 'Logout' link. The main navigation menu includes 'Home', 'User and Terminal', 'Access Control', 'Card', and 'Log and Report'. The 'Card List' section is active, showing a search bar with 'All card' selected and a 'Register a Card' button. Below the search bar is a table with the following data:

Serial Number	Extension	Username	Status	Description	Date Created	Modify	Delete	
1	4000238	1008	Kwon hyojun	✓ Specified	Temporary cards are issued.	2011-07-08 15:59:03		
2	123456789			□ Unspecified		2011-07-22 16:17:04		

At the bottom of the page, there is a pagination control showing 'Page 1 of 1' and a 'Total: 2' indicator. The footer contains the 'AddPac' logo and 'Copyright © 2011 AddPac Technology, Inc.'

DACM (Door Access Control Manager)

Access Log Management

The screenshot shows a web browser window displaying the 'Door Access Control System' interface. The page title is 'Door Access Control System' and the URL is '172.16.1.19/dacm/eventLog'. The user is logged in as 'Administrator'. A notification banner at the top right states 'Access control setting changed' and provides a link to 'Apply setting, click here to transmitting to terminal.' The main content area is titled 'Event Log' and includes a search section with fields for 'Duration' (11-07-10 to 11-08-09), 'User Extension Number', and 'Event Level' (set to 'Error'). Below the search section is a table of event logs.

	Time	Level	User Extension	Event
1	2011-07-15 10:27:27	Warning	1000	authentication failure
2	2011-07-15 11:25:27	Notice	1000	registration success
3	2011-07-15 12:21:27	Notice	1200	registration success
4	2011-07-16 09:27:27	Information	1201	door opened
5	2011-07-16 11:27:27	Information	1007	registration success
6	2011-07-16 17:12:00	Notice		security profile downloading completed
7	2011-07-17 18:00:00	Notice		system started

The interface also includes a pagination bar at the bottom of the table showing 'Page 1 of 1' and a 'Total: 7' count. The footer of the page contains the 'AddPac' logo and 'Copyright © 2011 AddPac Technology, Inc.'



Thank you!

AddPac Technology Co., Ltd.
Sales and Marketing

Phone +82.2.568.3848 (KOREA)

FAX +82.2.568.3847 (KOREA)

E-mail : sales@addpac.com