



# AP-SHD50

## Smart Hub for Z Sensors & Legacy Wired Sensors

High Performance Smart Home Solution for Wired/Wireless Sensors



**AddPac**

**AddPac Technology**

Sales and Marketing

[www.addpac.com](http://www.addpac.com)

# Contents

- Product Overview
- Hardware Specification
- APOS Technology
- Network Protocols
- Network Management
- Security Management
- Application Service
- Ordering Information

# Product Overview

## AP-SHD50 Smart Hub for Z Sensors & Wired Sensors

- Advanced Smart Home Solution
- Zigbee/Zwave Dual Sensor Interface Support
- Legacy Wired Sensor Interface Support
- Smart IP Routing Service Features for Sensor Network
- Smart Wall Pad Interworking Service Features
- Smart Hub Interworking Support for Third Party
- High Performance RISC Programmable Architecture
- One 10/100Mbps Fast Ethernet
- PoE Support : Option
- High Performance LAN-to-Zigbee/Zwave Routing Capability
- Powerful Network Protocols (PPPoE, DHCP, Static Routing, etc)
- Firmware Upgradeable Architecture
- Smart Web based Management
- Light and Compact Design with External Power Supply

# Product Highlights

AP-SHD50 Smart Hub for Z Sensors & Wired Sensors

## Powerful Smart Hub for Z Sensors & Wired Sensors

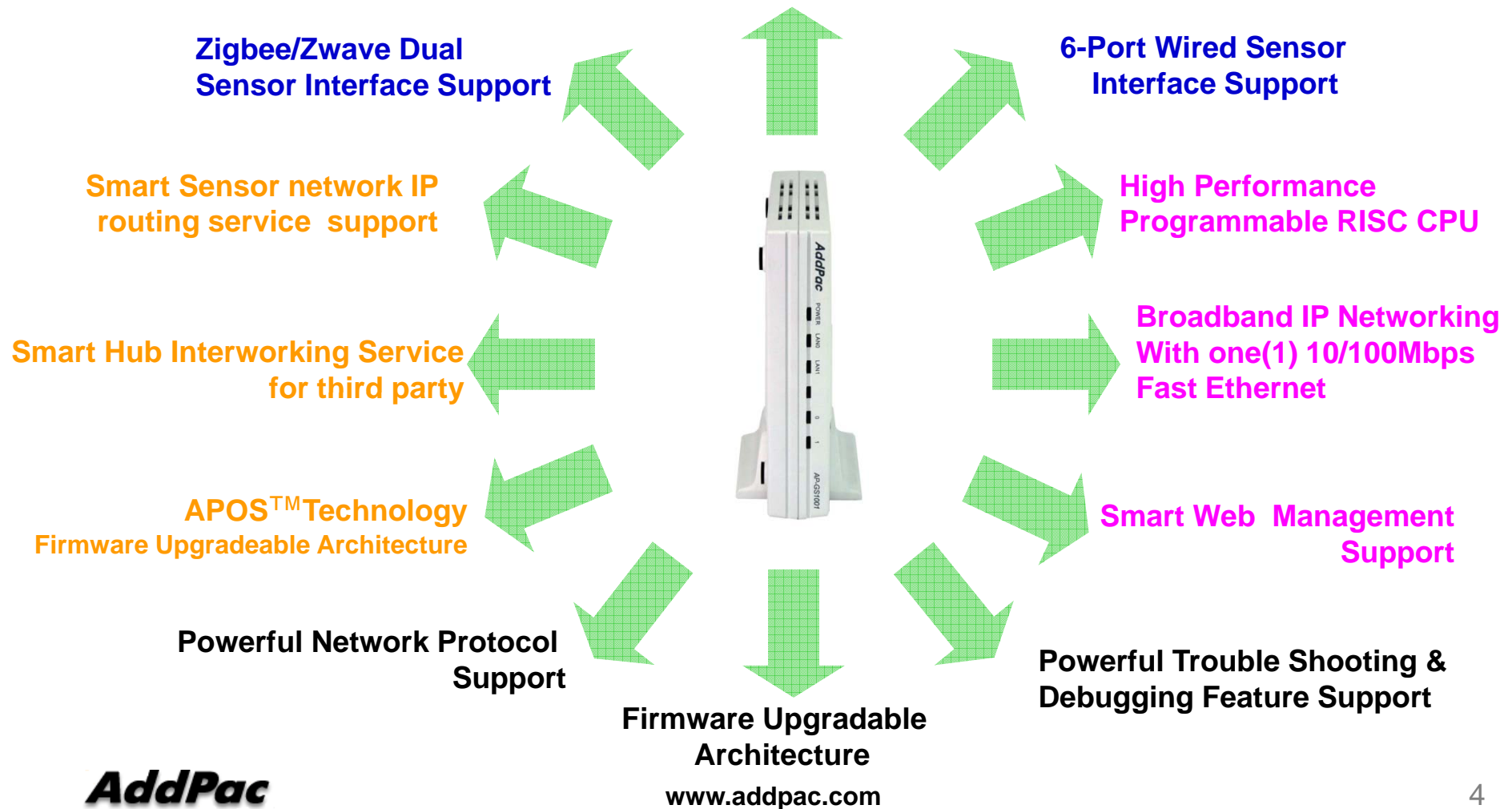

# APOS Technology

AP-SHD50 Smart Hub for Z Sensors & Wired Sensors

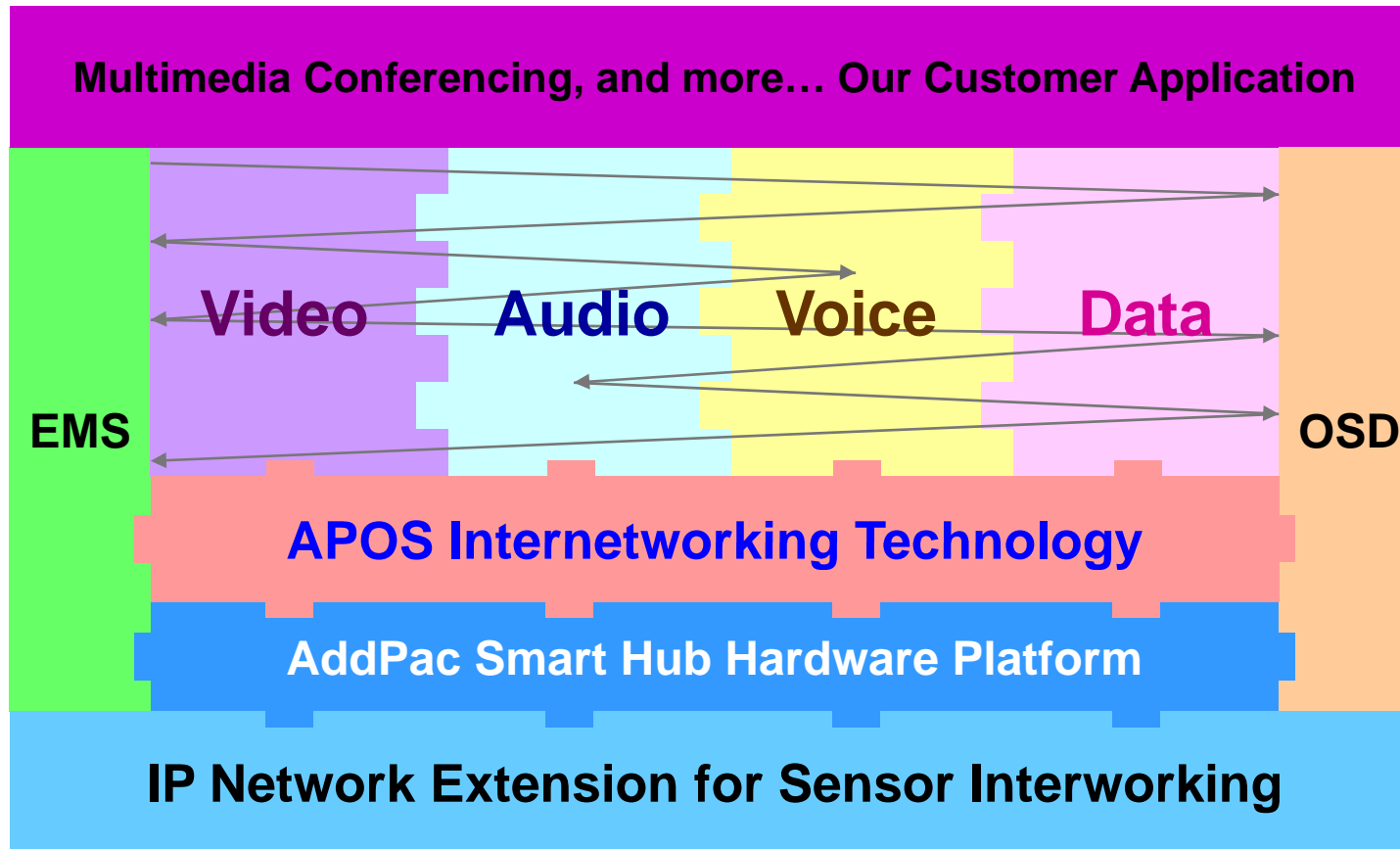

- APOS : AddPac Internetworking Operating System
- OSD : On- Screen Display
- EMS : Element Management System

# Hardware Specification

AP-SHD50 Smart Hub for Z Sensors & Wired Sensors

A square logo with a dark blue background and a light blue border. The text "RISC" is positioned above "CPU" in white, bold, sans-serif font.

- RISC Microprocessor Computing Power
- 1-Port Zigbee Interface
- 1-Port Zwave Interface
- 6-Port Wired Sensor
  - Alarm Input
  - Power Output for Sensor Power Supply
- Speaker Port, Beacon Port
- Network Interface
  - One(1) 10/100Mbps Fast Ethernet (RJ45)
- LAN LED, Port LEDs
- External Power Supply
- PoE (Power over Ethernet) : Option

# Hardware Specification

AP-SHD50 Smart Hub for Z Sensors & Wired Sensors

RISC  
CPU

## Smart Hub Service Diagram

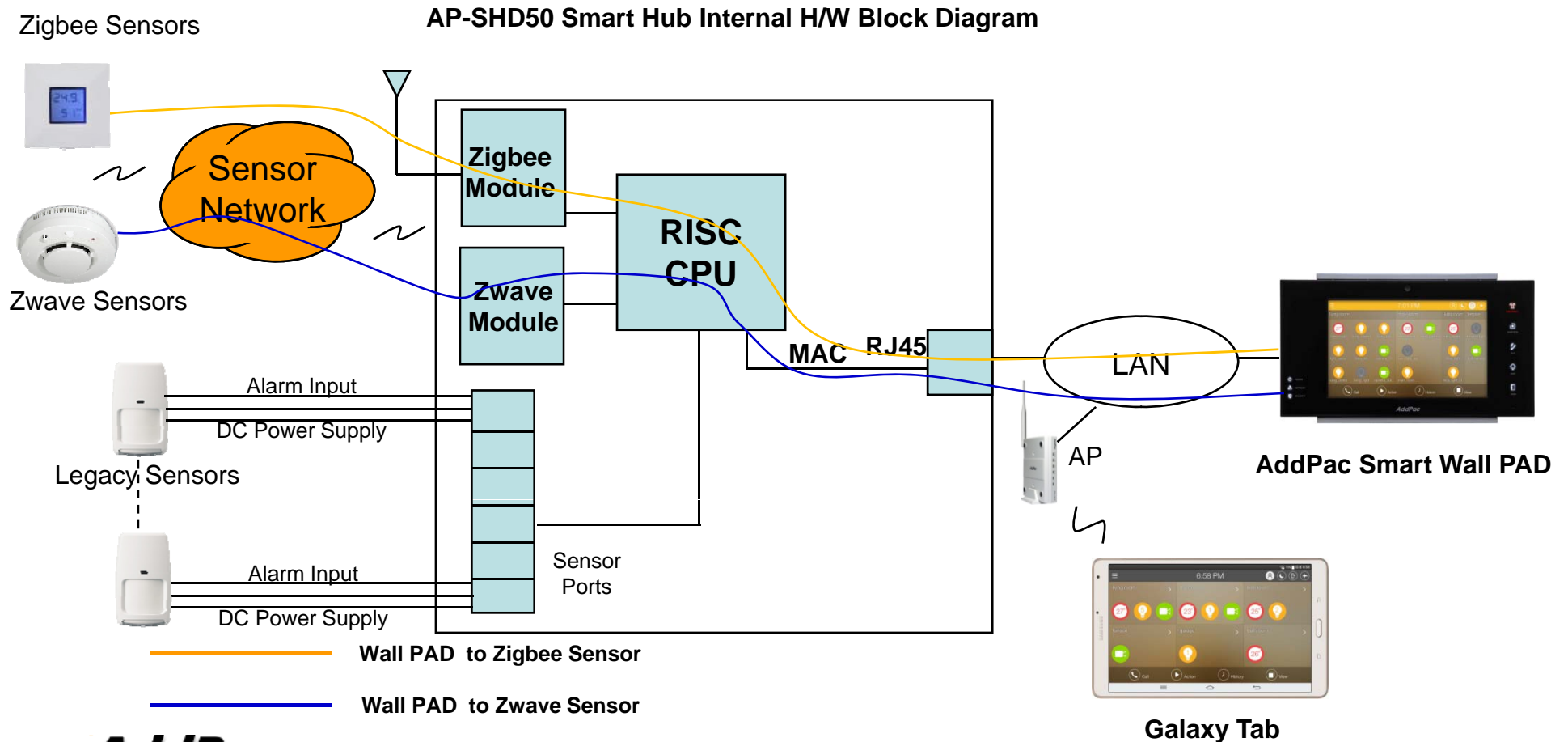

# Hardware Specification

## AP-SHD50 Smart Hub for Z Sensors & Wired Sensors

<b>AP-SHD50 Smart Hub</b>	<b>Basic Specifications</b>
<b>Wireless Sensor Interface</b>	One(1)-Port Zigbee Interface
	One(1)-Port Zwave Interface
<b>Zigbee Antenna Interface</b>	External Zigbee Antenna
<b>Zwave Antenna Interface</b>	External Zwave Antenna
<b>Wired Sensor Interface</b>	Six(6)-Port Wired Sensor Interface (alarm input, dc power supply)
<b>Control Interface</b>	Speaker, Beacon Control Interface
<b>Ethernet Interface</b>	1-Port 10/100Mbps Ethernet Interface(1 x RJ-45)
<b>Flash Memory</b>	4Mbyte High-speed Flash Memory
<b>Base Memory</b>	32Mbyte High-speed SDRAM
<b>Power Requirement</b>	Power Supply Adaptor / VAC 110~220V, 50/60Hz, 12V, 2A
<b>Operating Temperature</b>	0°C ~ 45°C (32 °F ~ 122°F)
<b>Storage Temperature</b>	-40°C ~ 85°C (-40°C ~ 185°F)
<b>Relative Humidity</b>	5% ~ 95% (Non-condensing)
<b>Dimension</b>	142mm x 142mm x 28mm (W x D x H)
<b>Weight (Kg)</b>	0.42Kg



# Hardware Specification

AP-SHD50 Smart Hub for Z Sensors & Wired Sensors

## Network interface Configurations

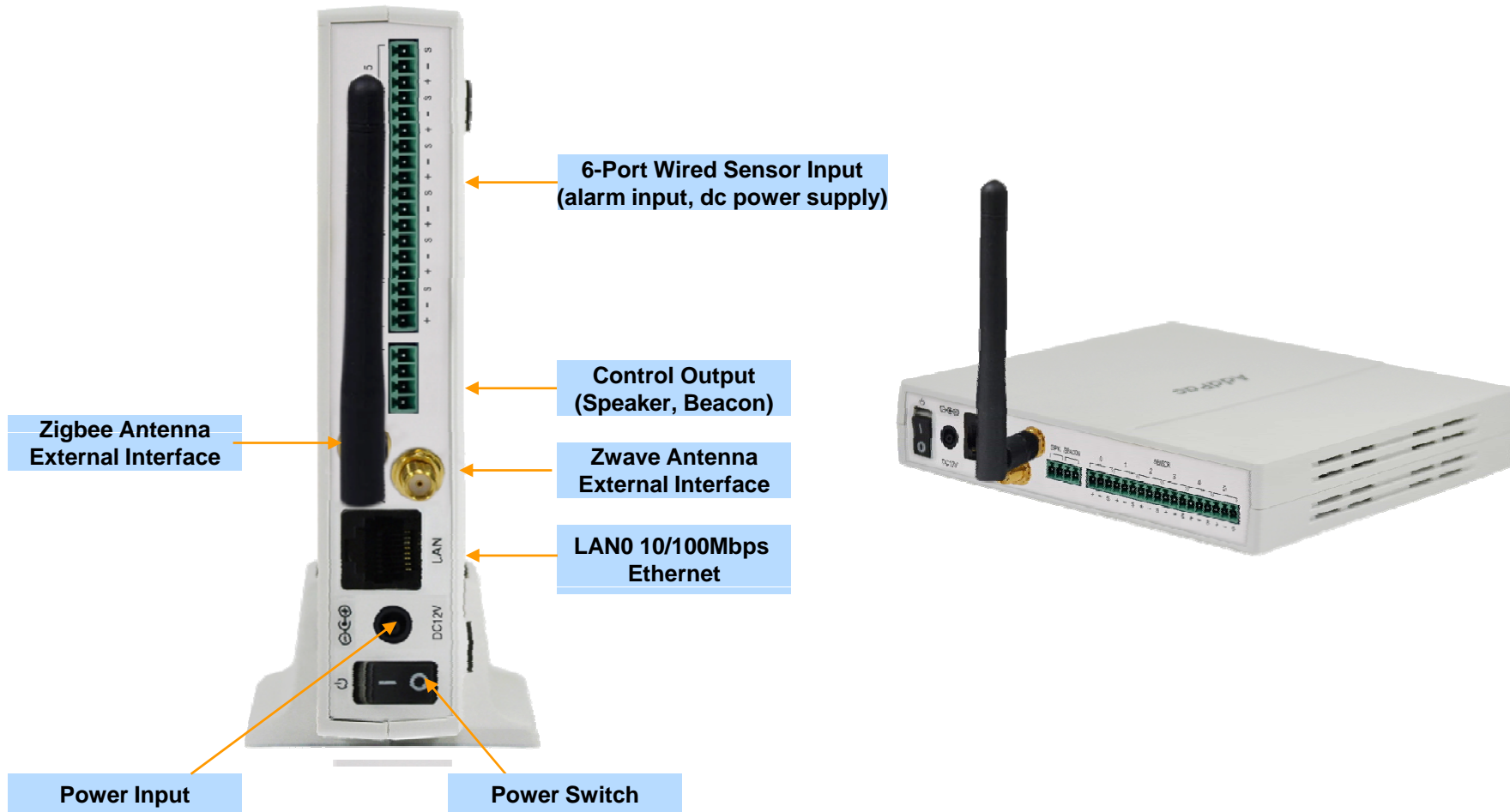

# Network Protocols

AP-SHD50 Smart Hub for Z Sensors & Wired Sensors

## Basic Network Protocols

- ARP, IPv4, TCP, UDP, ICMP, SCTP, IGMP, MLD

## Routing Protocol

- IPv4 : Static

## Service Protocol

- FTP, Telnet, TFTP, DHCP Server/Relay, SNMP Server
- CDP (Cisco Discovery Protocol)
- DNS Resolver , DDNS(nsupdate)
- Bridge
- Syslog

## IPv4 Address Configuration

- Fixed (Static)
- DHCP
- PPPoE

## Miscellaneous

- Cisco Style CLI
- Standard & Extended IPv4 Access List
- Multi-level User Account Management
- IP accounting
- STUN Client

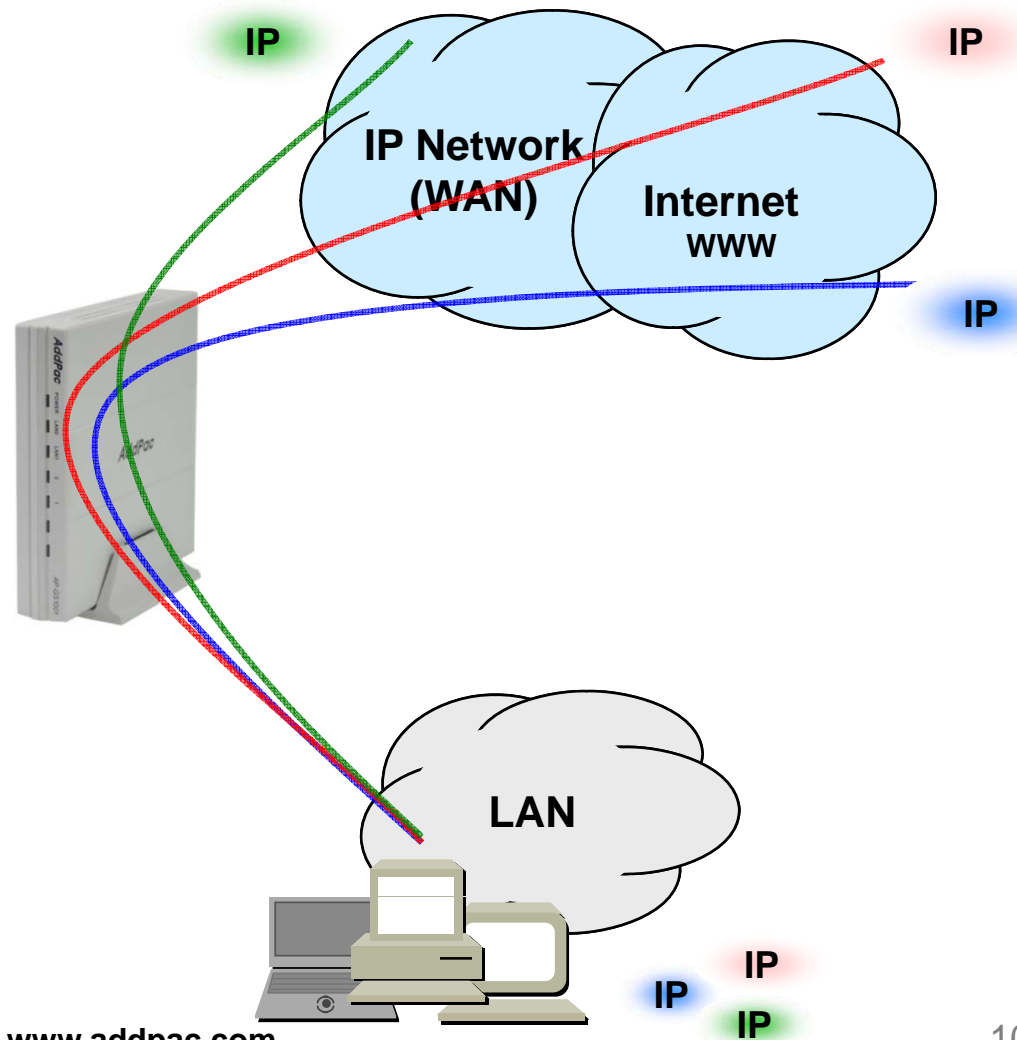

# Network Management

## AP-SHD50 Smart Hub for Z Sensors & Wired Sensors

- **SNMP**

- Standard Simple Network Management Protocol( SNMP) Agent support
- MIB v1 and v2 Support

- **Web-based Management**

- Smart Easy Setup
- Standard Voice Interface
- Standard PSTN Back-up Interface

- **Watch-dog Function**

- Hardware, Software watch-dog services

- **Remote Management**

- Telnet
- Rlogin

- **Auto Upgrade Service**

- HTTP server based APOS image and configuration file auto-upgrade support

- **Batch Job Function**

- Text based script downloading

- **Interoperable with AP-VPMS Service**

- AddPac VoIP Plug & Play Management System (AP-VPMS)

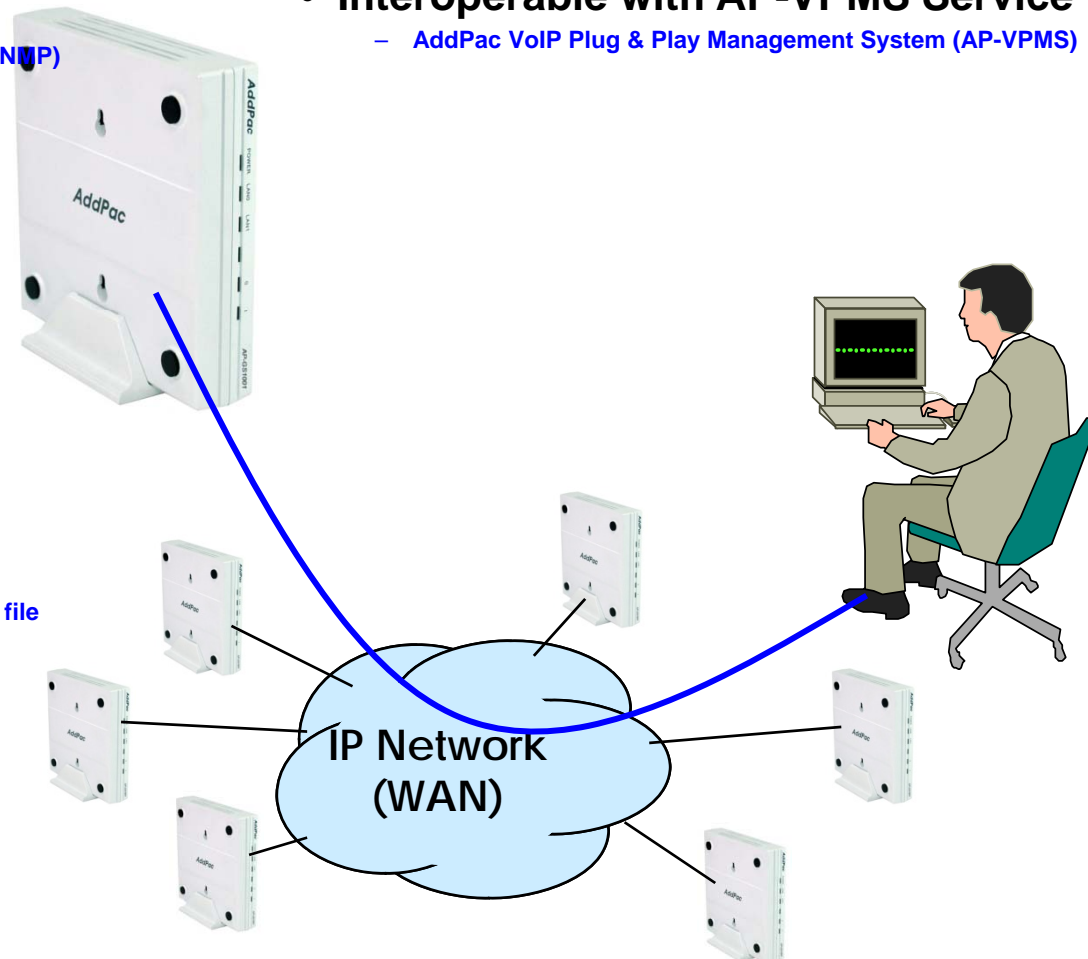

# Security Management

AP-SHD50 Smart Hub for Z Sensors & Wired Sensors

- IP packet filtering
- IP access list
- User authentication function
  - Password Authentication Protocol (PAP)
  - Challenge Handshake Authentication Protocol (CHAP)
- Enable/Disable specific protocols
- Auto-square connect of Telnet session
- Account Management function for multi-level user
- SNMP/TELNET/FTP/HTTP/TFTP port assignment function
- SNMP/TELNET/FTP access list management
- Boot mode security checking function

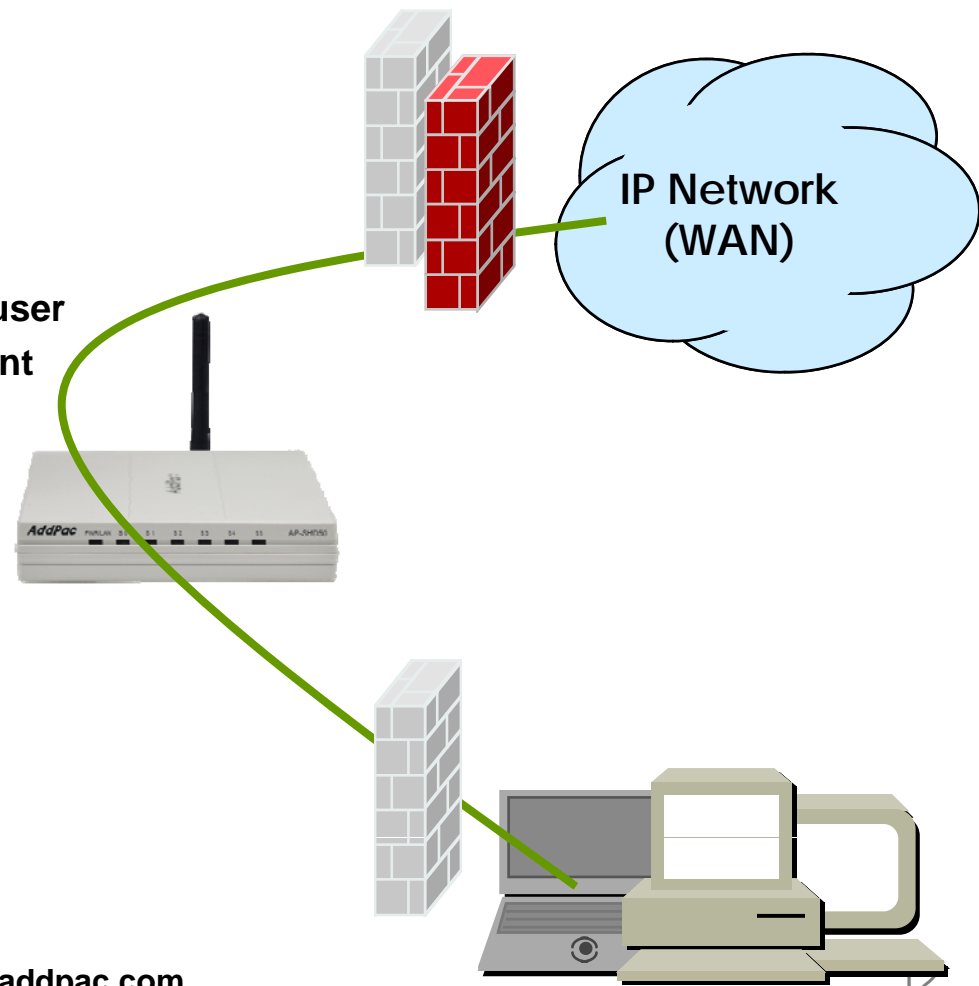

# Standard Application

AP-SHD50 Smart Hub for Z Sensors & Wired Sensors

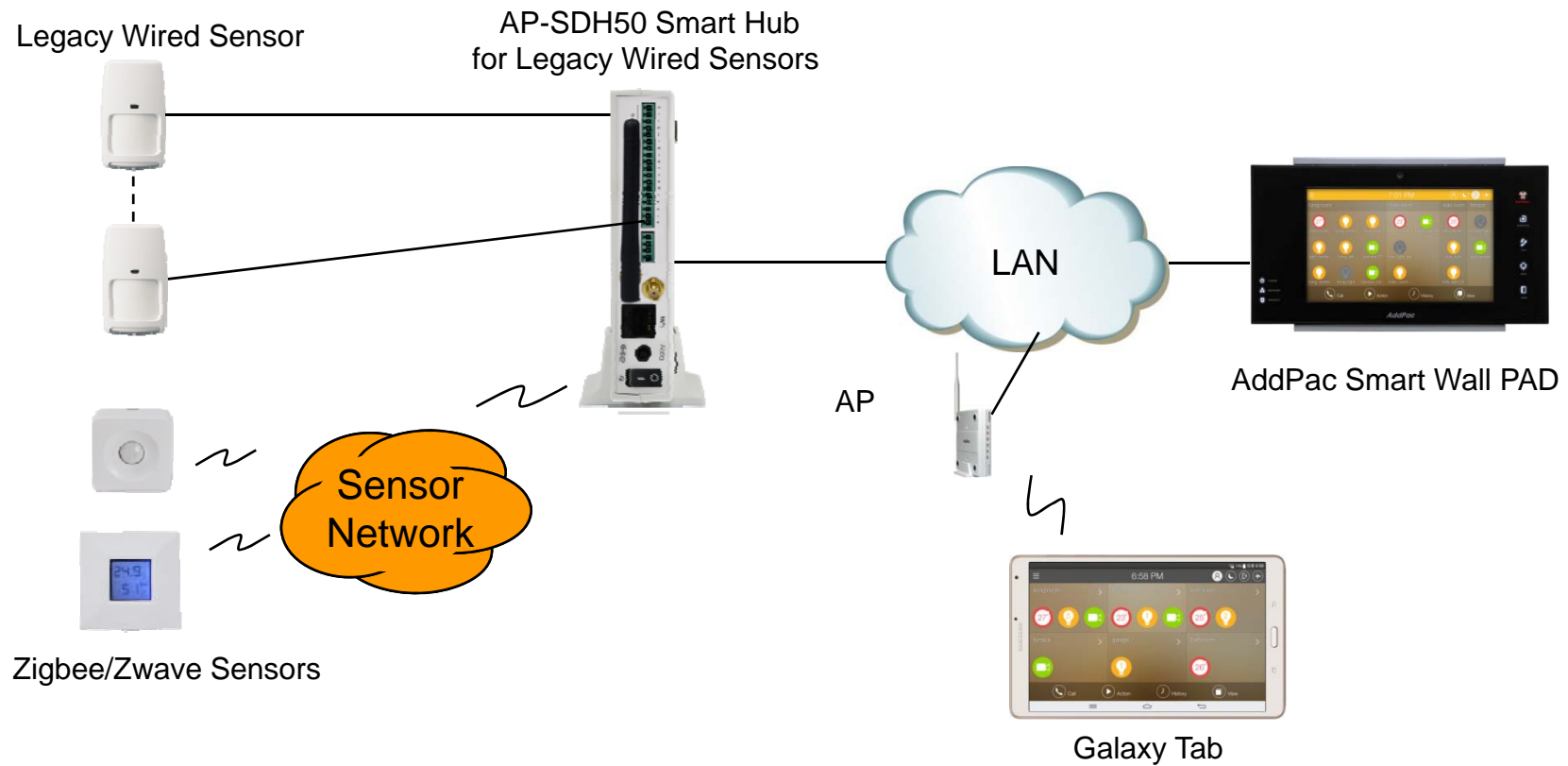

# Standard Application

## AP-SHD50 Smart Hub for Z Sensors & Wired Sensors

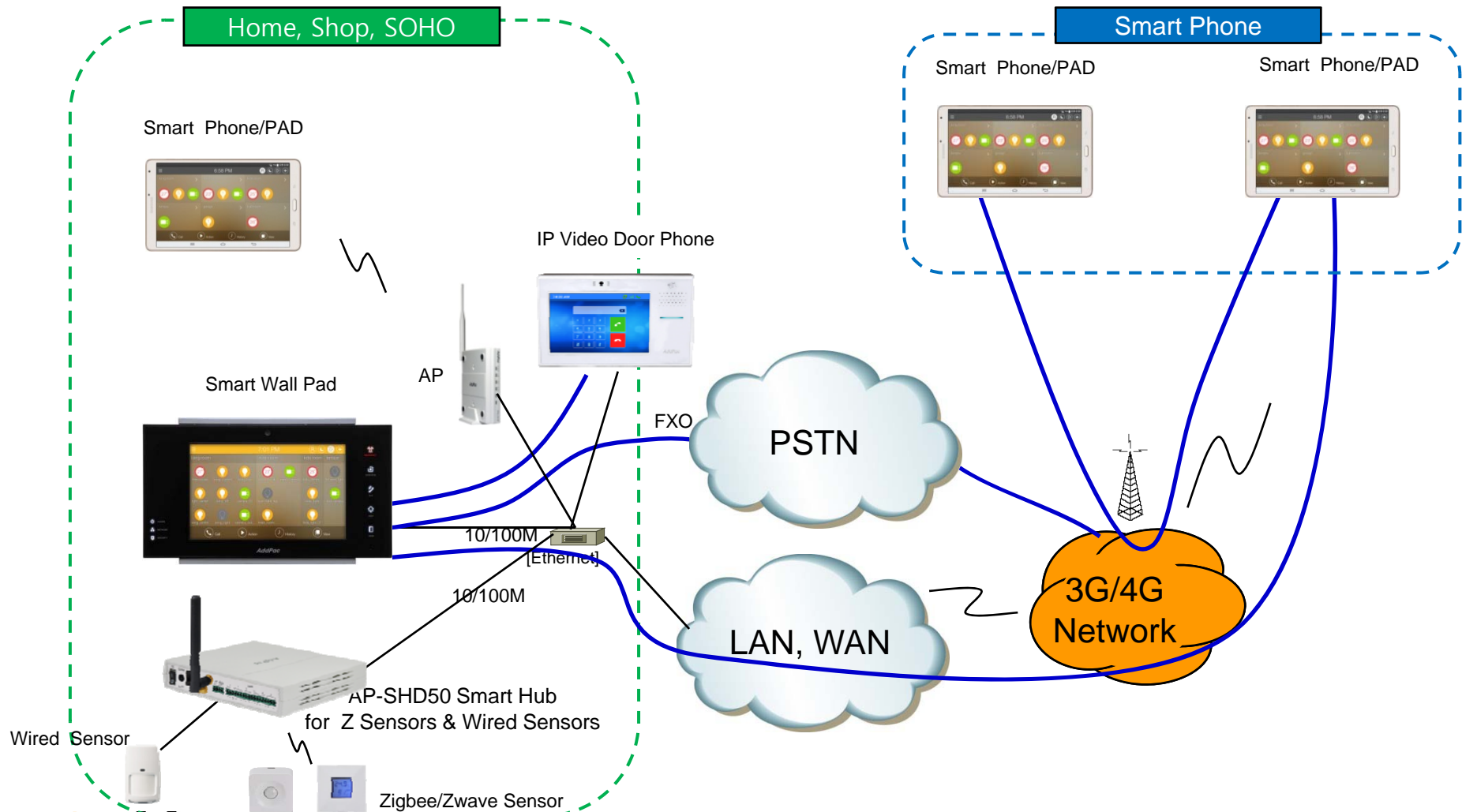

# Ordering Information

- **AP-SH50 Smart Hub Hardware**
  - AP-SH50 Smart Hub Main Body
  - RISC Microprocessor
  - 1-Port Zigbee Interface with external antenna
  - 1-Port Zwave Interface with external antenna
  - 1-port 10/100Mbps Fast Ethernet(RJ45)
  - Including Network Cable, Antenna & Ext. Power Supply, etc.
- **Built-in APOS Internetworking Software for AP-SHD50**
- **Including 1 Year Hardware Warranty**
- **Product Documents**
  - Install and Operation Guide (PDF)
- **Pricing**
  - AddPac Technology Regional Sales Manager
  - Authorized Sales and Marketing Representatives
  - Please Contact [www.addpac.com](http://www.addpac.com)

# Smart Hub Series

# Thank you!

**AddPac Technology Co., Ltd.**  
Sales and Marketing

Phone +82.2.568.3848 (KOREA)

FAX +82.2.568.3847 (KOREA)

E-mail [sales@addpac.com](mailto:sales@addpac.com)