



PassFinder

AP4820

MultiService Router



Oct. 2003

Technical Sales and Marketing

AddPac Technology

www.addpac.com

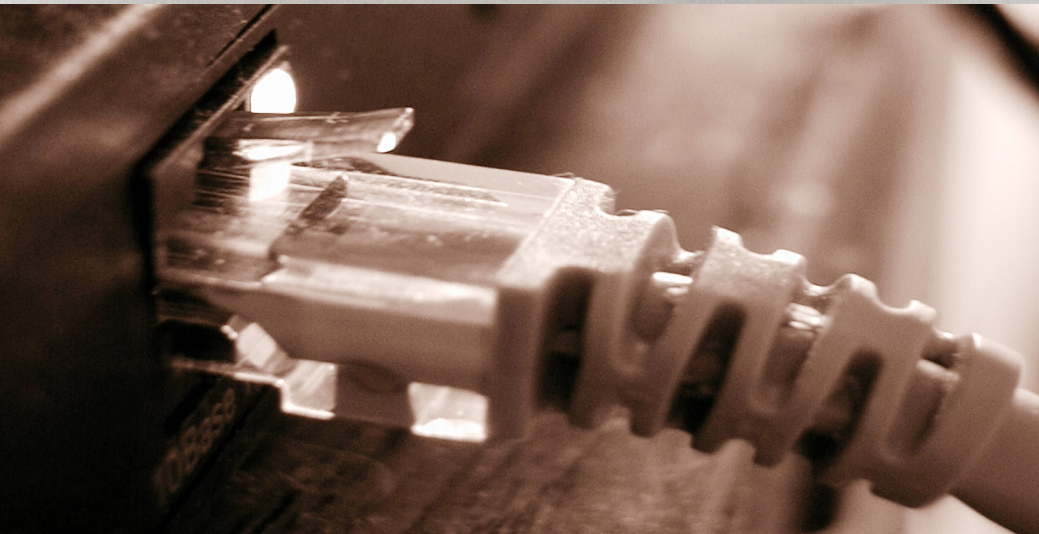

AP4820 MultiService Router Product Overview

APOS Internetworking Protocol Stack

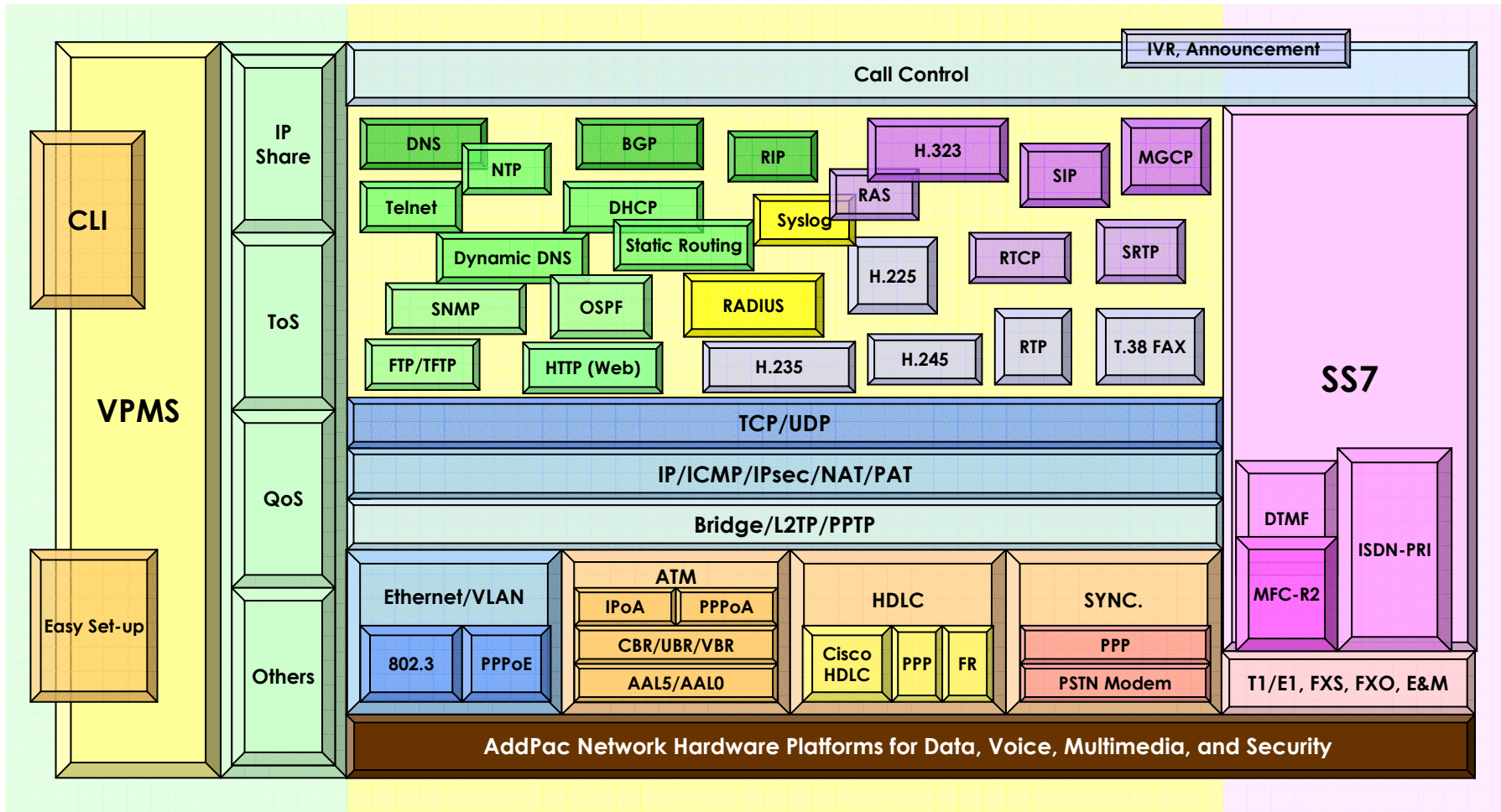

AP4820 Multiservice Router Product Overview

APOS Internetworking S/W World (cont.)

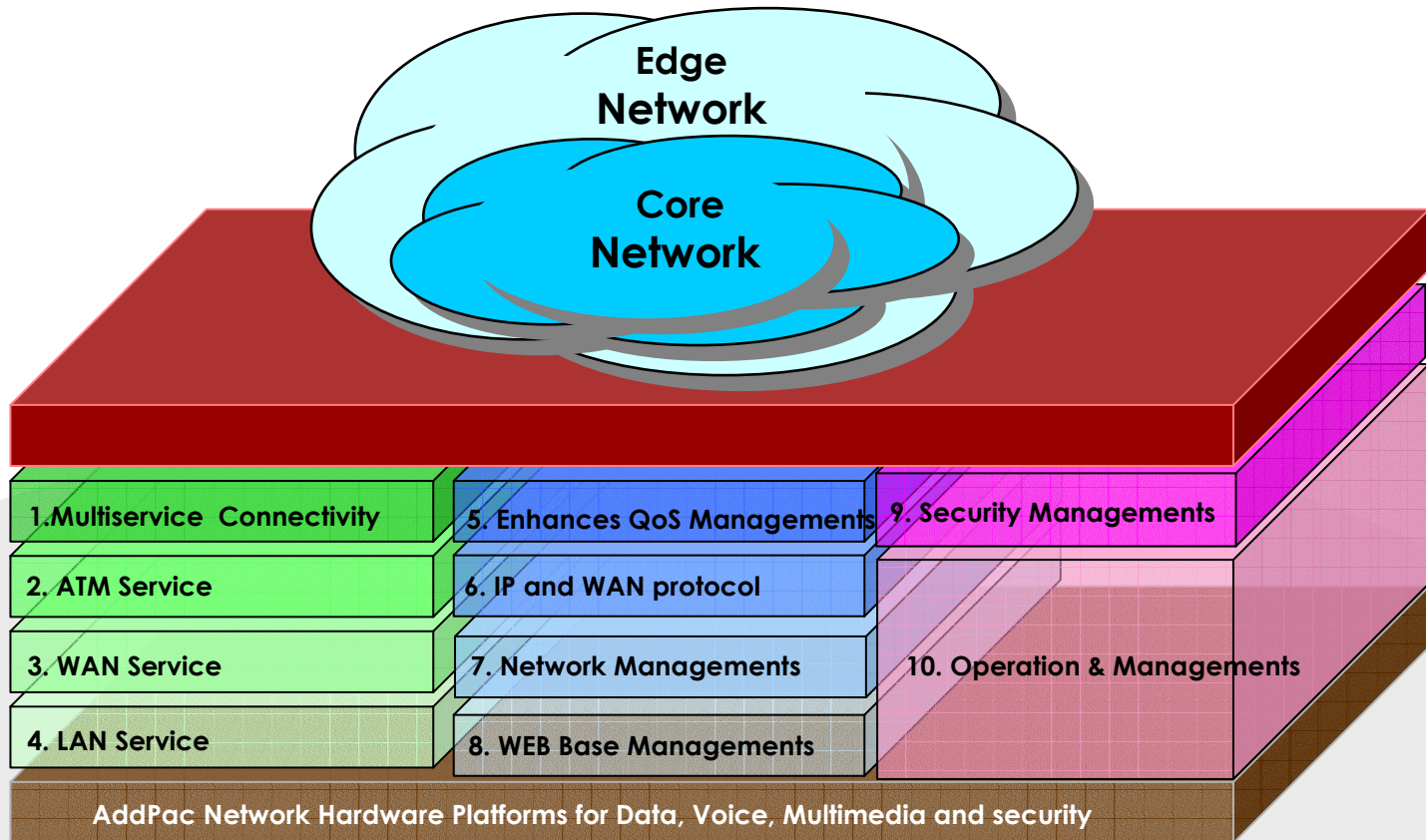

AP4820 Multiservice Router Product Overview

ATM Service

- Standard 45Mbps DS3 ATM service
- Standard 155Mbps OC3(STM-1) ATM Service
- ATM PVC UNI3.0, 3.1, 4.0 Support
- RFC1483 and RFC1577 based IPoA Service
- PPPoA and PPPoE Services
- ATM Classes of Service Support
 - ATM PVCs and SVCs Service
 - CBR, rt-VBR, nrt-VBR, UBR, and UBR+ Support
 - AAL0 ,AAL5
- PCR and MCR Service
- ATM Traffic Management Support
- VBR Type 1 and Type2 Support
- provide Priority Level of 8-layer with ATM Pace Control
- Traffic shaping on a per-VC basis

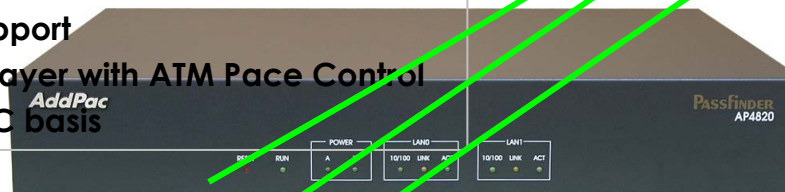

PPPoA

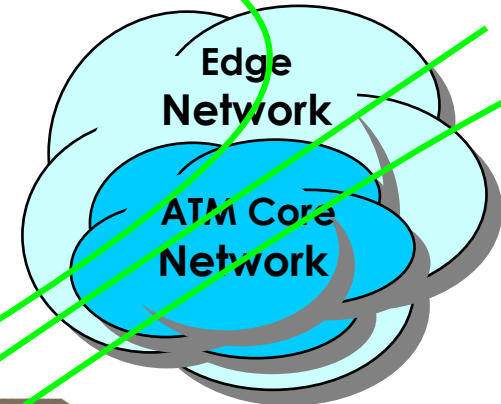

IPoA



AP4820 Multiservice Router Product Overview

WAN Service

- 45Mbps DS3 ATM Interface Support
- 155Mbps OC3 ATM Interface Support
- 45Mbps T3 Packet over Sonet(POS) Interface Support
- 45Mbps T3 High Speed Serial Interface(HSSI) Support
- 6 Channel V.35 Interface Support
- Point-to-Point Protocol(PPP) Support
- Frame-Relay PVC with Inverse ARP Support
- High-level Data Link Control (HDLC) Protocol Support
- HDLC Encapsulation Support (Interoperability with CISCO HDLC)

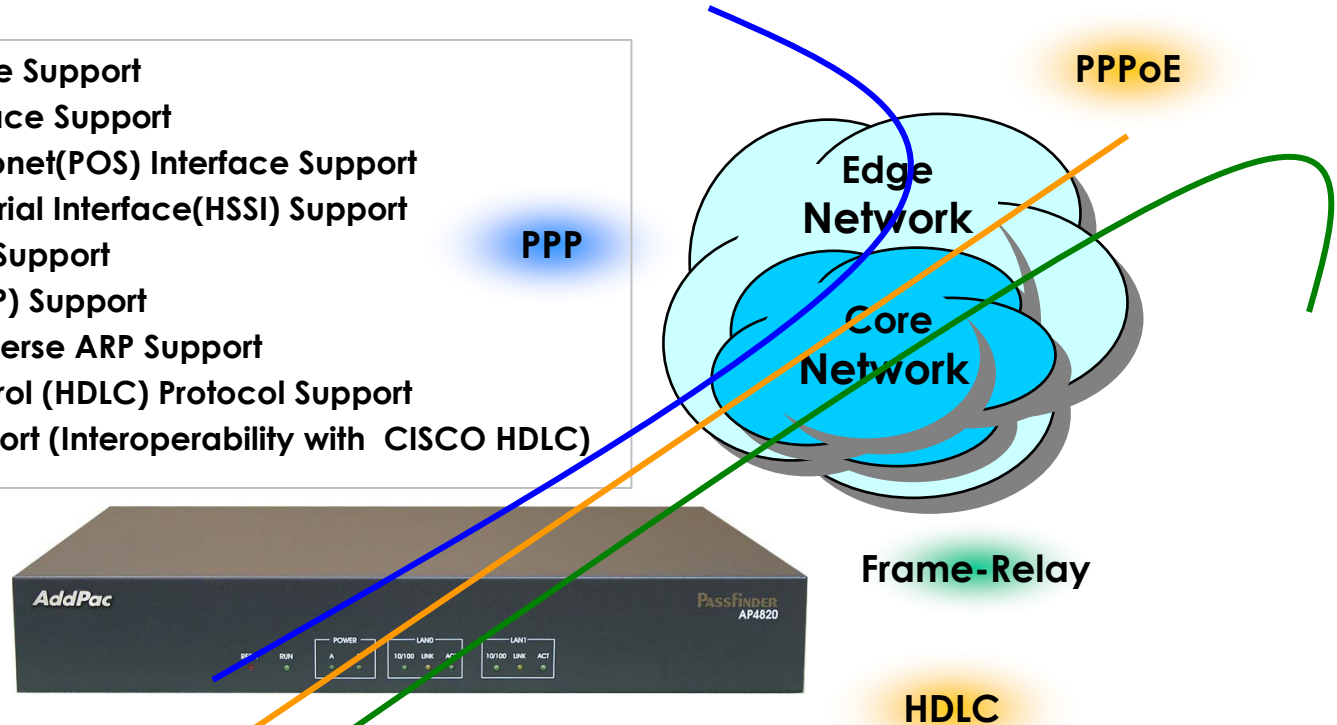

AP4820 Multiservice Router Product Overview

LAN Service

- Ethernet Interface
 - Dual 10/100Mbps Fast Ethernet Interface
 - Auto Sensing
- Configuration Management Function
 - Port Configuration Function
 - Secondary/Subnet Support
 - MTU Size change Function
 - Transmit/Receive connection recovery Function

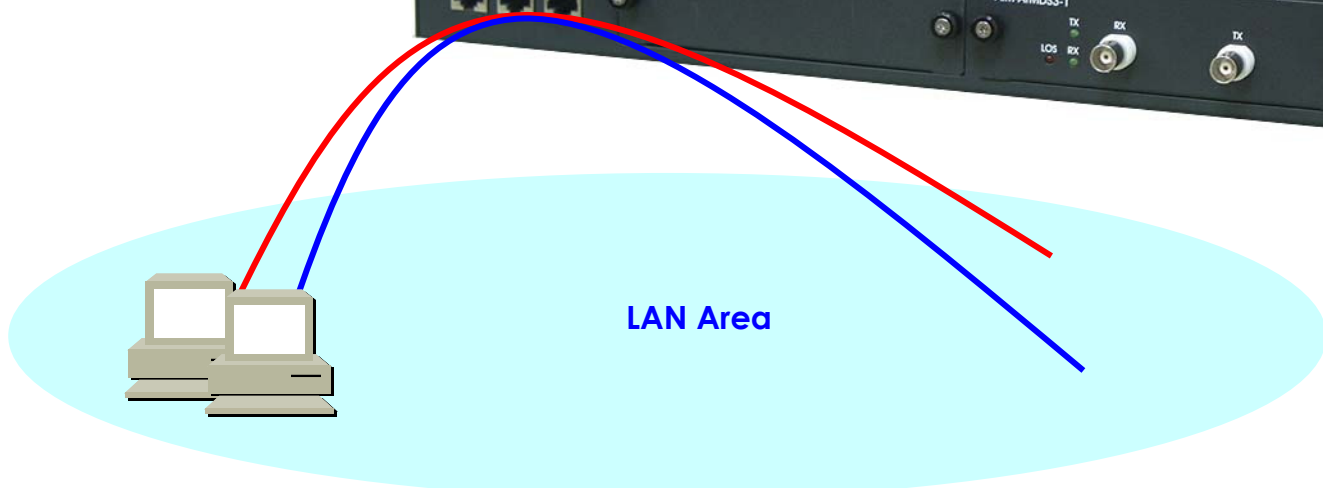

AP4820 Multiservice Router Product Overview

WEB Based Management

- **WEB Based Management (GUI)**
 - Web Based Management using HTTP Server Interface
 - Easy Setup
 - Graphical User Interface (GUI)



Ethernet

<http://a.b.c.d>

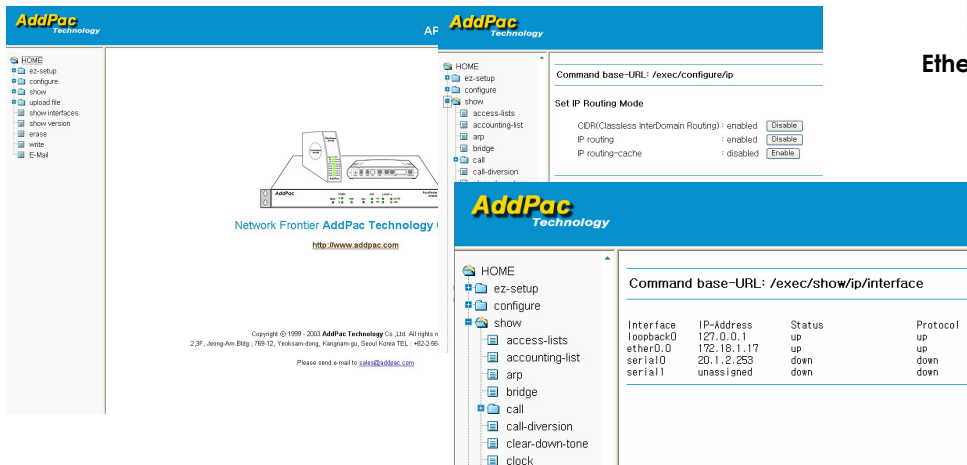

Command base-URL: /exec/configure/ip

Set IP Routing Mode

CDR(Classless InterDomain Routing) : enabled

IP routing : enabled

IP routing-cache : disabled

Command base-URL: /exec/show/ip/interface

Interface	IP-Address	Status	Protocol
loopback0	127.0.0.1	up	up
ether0/0	172.18.1.17	up	up
serial0	20.1.2.253	down	down
serial1	unassigned	down	down



AP4820 Multiservice Router Product Overview

Operation & Management

- **System Performance Analysis**
 - Process Check Analysis
 - CPU, Connection Interface Analysis
- **Configuration Management**
 - APOS and Configuration Backup, Restore
 - Configuration Erase, Save
- **Debugging and Diagnostics**
 - Data Packet Decoding for APOS Protocols
- **System Booting and Auto Rebooting**
 - Fast booting into 30 second
 - Watch Dog Function for High-Availability
- **System Managements**
 - Data Logging and IP Traffic Statistics
 - Command HELP and History
 - Command Line Interface (CLI)

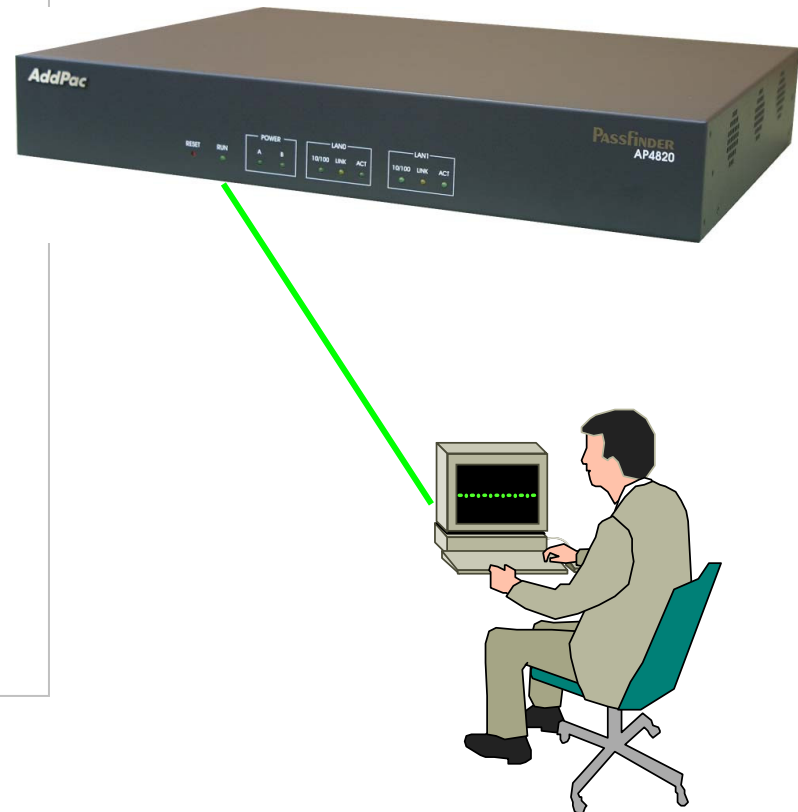

AP4820 Multiservice Router Product Overview

AP4820 Hardware Specification

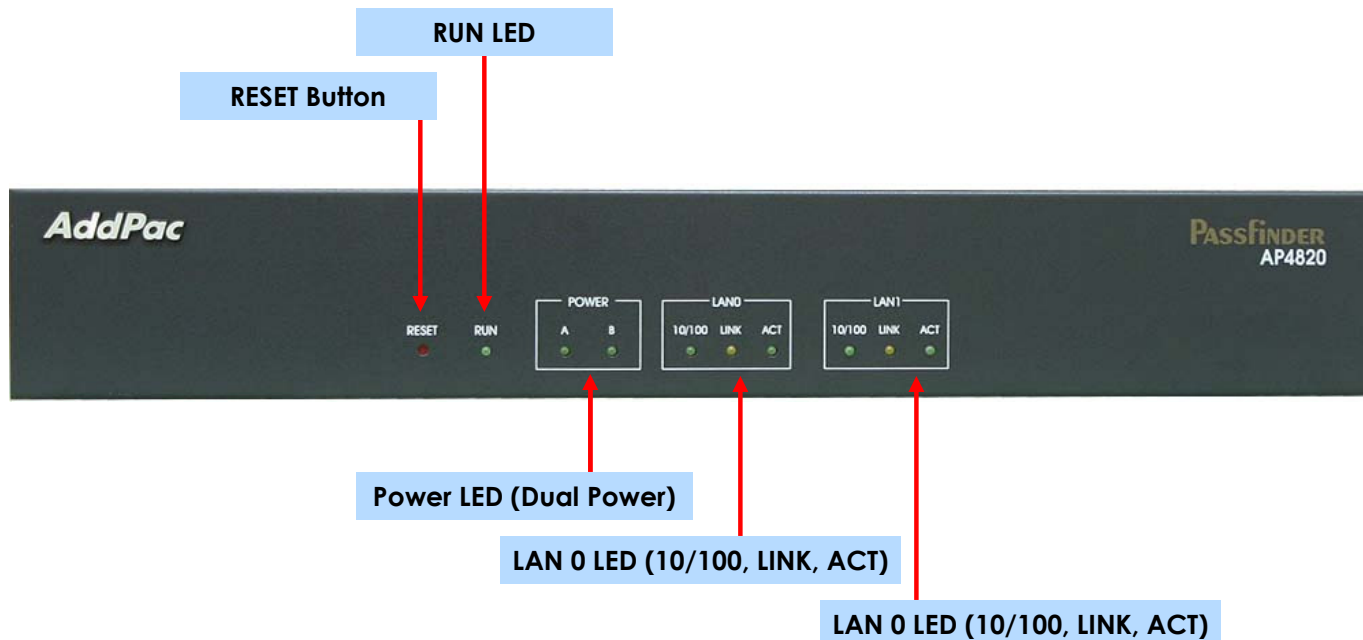

AP4820 Multiservice Router Product Overview

AP4820 Hardware Specification (Cont.)

Hardware Specifications

AP4820 ATM Router	Basic Specifications
CPU	64Bit RISC Microprocessor
Network Modules	Two(2) Multiservice Network Modules Slots
Fixed Network Interface	2-Ports 10/100Mbps Fast Ethernet Interface 1-Port Asynchronous Serial Interface (RJ45)
Fixed Network Interface	1-Port 45Mbps DS3 ATM Network Module(BNC)
	1-Port 45Mbps T3 HSSI Network Module (D-Sub)
	1-Port 45Mbps T3 PoS Network Module(BNC)
	1-Port 155Mbps OC-3 ATM Network Module
Memory	8Mbyte High-speed Flash Memory
	64Mbyte High-speed SDRAM
	512Kbyte Flash Memory
Power Requirement	VAC 110~ 220V Auto sensing, 50/60Hz Dual Power
Operating Temperature	0°C ~ 55°C (32 °F ~ 112°F)
Storage Temperature	-40°C ~ 85°C (-40°C ~ 185°F)
Relative Humidity	5% ~ 95% (Non-condensing)
Dimensions	43mm x435mm x 248mm (H x W x D)
Weight (g)	4.3Kg

Network interface Configurations

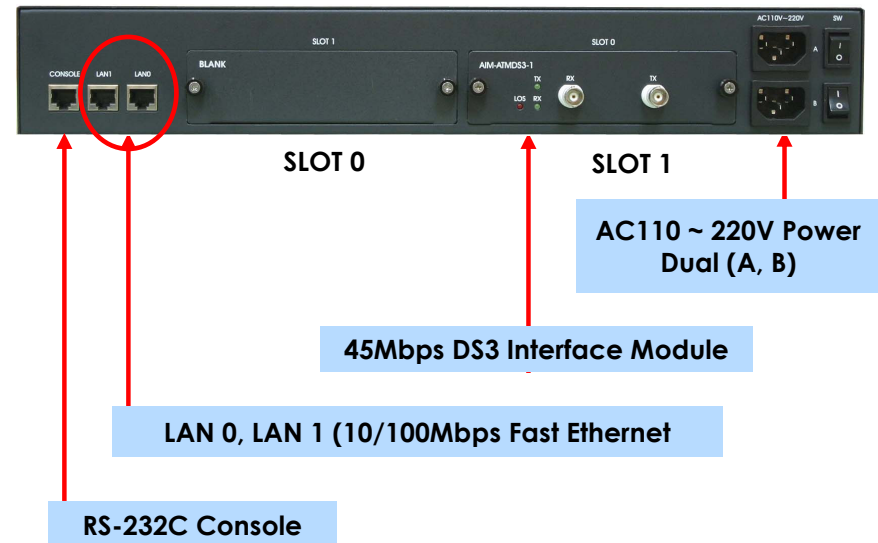

AP4820 Multiservice Router Product Overview

AP4820 Network Interface Module



•25Mbps ATM Network Interface Module



•OC3(155Mbps) ATM Network Interface Module



•DS3(45Mbps) POS/SDH Network Interface Module



•DS3(45Mbps) ATM Network Interface Module



•High Speed Serial Interface Module



•Multi Channel V.35 Network Interface Module

AP4820 Networking Configuration

ATM Multi-Service and Router Application

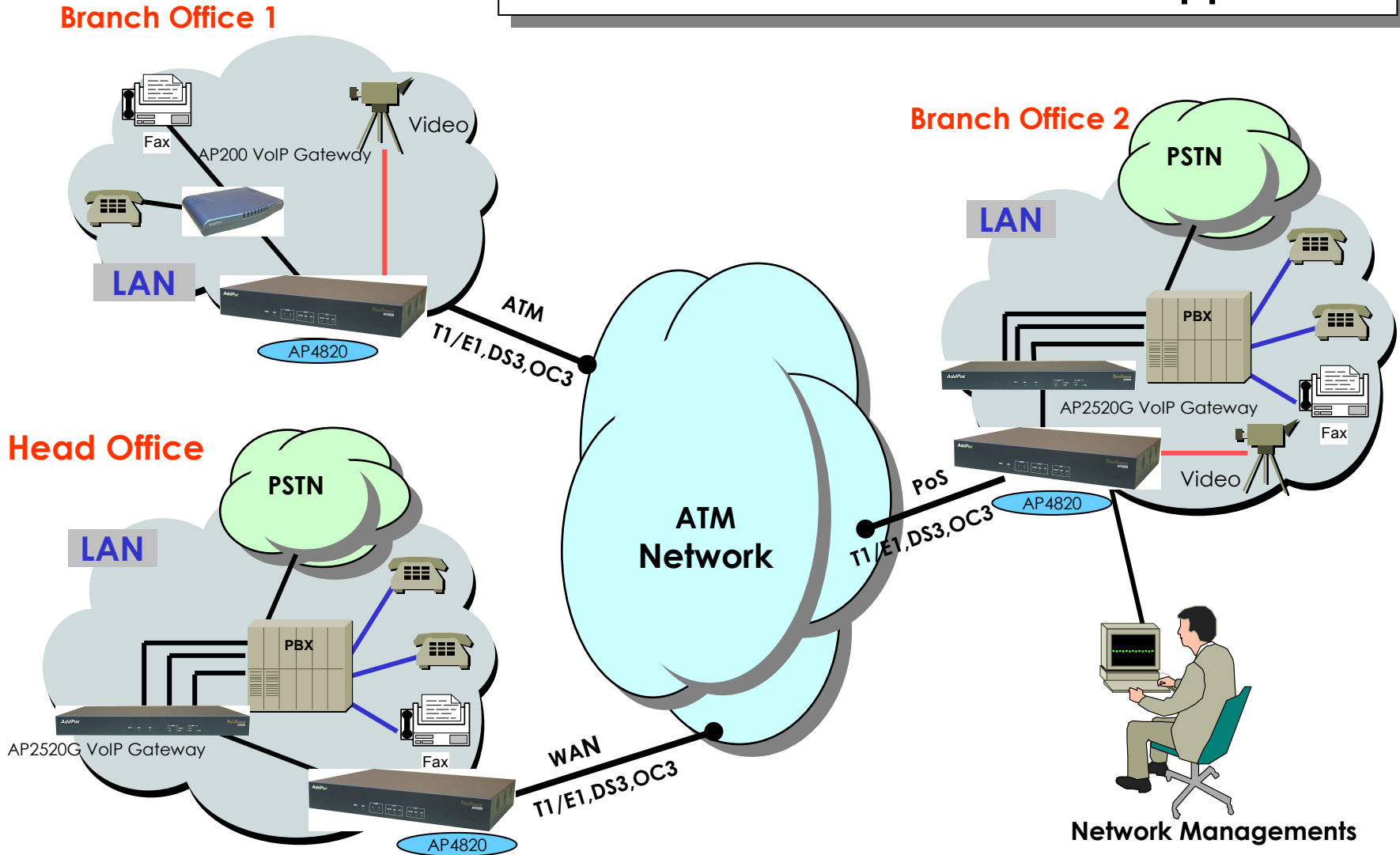

AP4820 Multiservice Router Networking Configuration

ATM Data Service

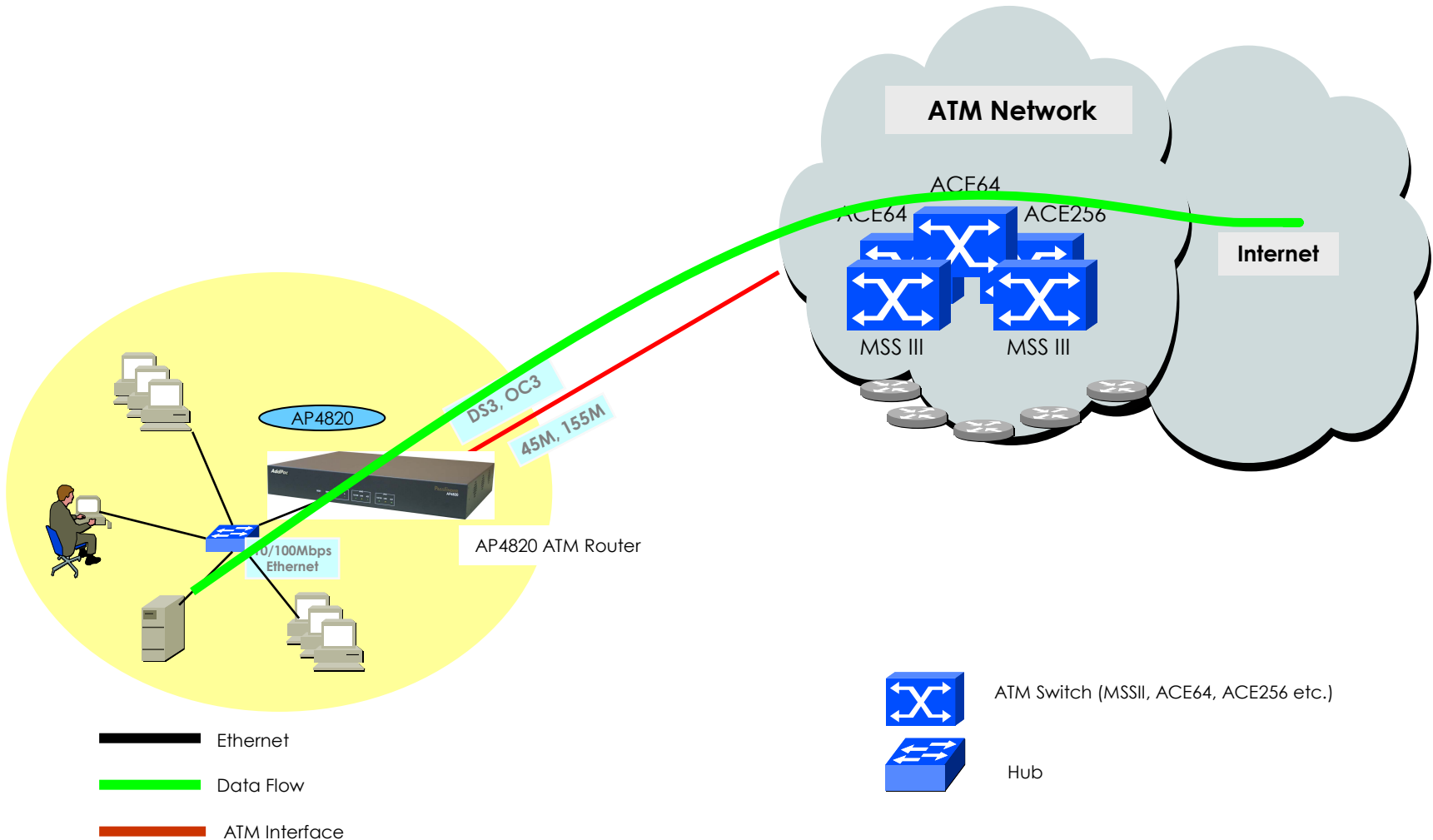

AP4820 Networking Configuration

ATM Router Application

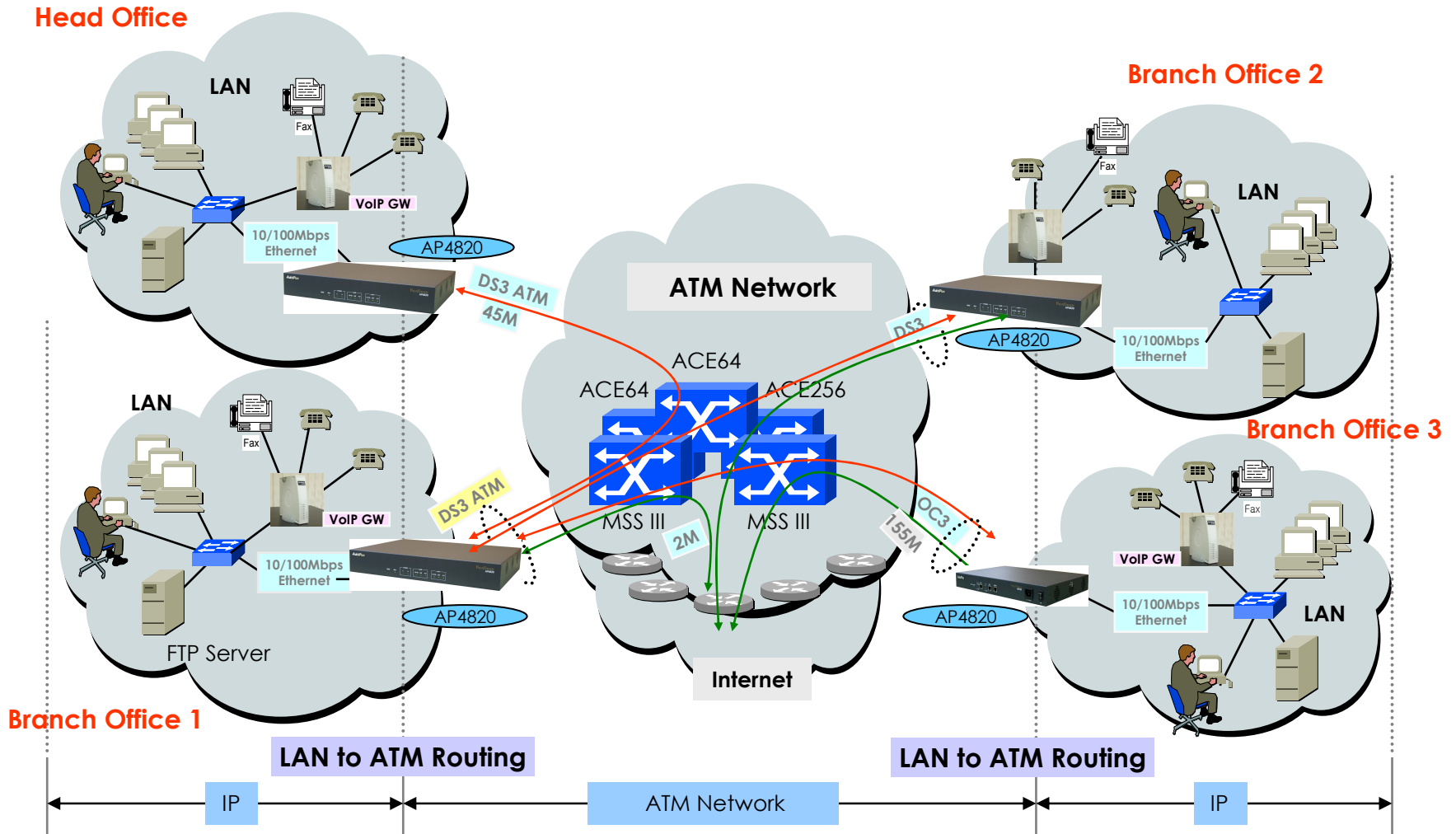

AP4820 Multiservice Router Product Overview

AP4820 Ordering and Pricing

• AP4820 Multiservice Router Series

– Order No:

AP4820-01 : AP4820 Multiservice Router Standard Configuration

Hardware

- High-speed 64bit RISC CPU
- Two(2) High-performance Network Module Slots for ATM, WAN, and PoS Interface
- Two(2) Ports 10/100Mbps Fast Ethernet (RJ45)
- One(1) port Async Serial Console Interface (RJ45)
- 8MB Flash, 64MB SDRAM
- Built-in APOS Internetworking Software
- Dual-Power Supply Unit/AC Input(Free Voltage)
- 1.5Ux19" Rack Mountable Chassis
- Including CAB-LAN, CAB-CON

CAB-LAN : RJ45 Ethernet Cable

CAB-CON : RJ45 RS-232C Console Cable



• Pricing

- AddPac Technology Regional Sales Managers
- Authorized Sales and Marketing Representatives
- Please Contact www.addpac.com

Thank you !

www.addpac.com