



AP-SAV100 Analog Voice Intercom IP Gateway

High Performance IP Extension Solution for Legacy Analog Door Phone



AddPac

AddPac Technology

Sales and Marketing

www.addpac.com

Contents

- Product Overview
- Hardware Specification
- APOS Technology
- VoIP Service
- Network Protocols
- Network Management
- Security Management
- Application Service
- Ordering Information

Product Overview

AP-SAV100 Analog Voice Intercom IP Gateway

- Analog-to- IP Video Gateway Solution for Analog Door Phone
- 1-Port FXS VoIP Gateway Interface Support
- SIP/H.323 Dual Stack VoIP Signaling Protocol
- DTMF Tone Relay to FXS Port (SIP/Network Cause Value)
- High-performance Voice Codec Support
 - G.723.1, G.729.A, G.726, G.711, etc
- High Performance RISC Programmable Architecture
- Two(2) 10/100Mbps Fast Ethernet
- High Performance LAN-to-IP Routing Capability
- Powerful Network Protocols (PPPoE, DHCP, Static Routing, etc)
- Firmware Upgradeable Architecture
- Smart Web based Management
- Light and Compact Design with External Power Supply

Product Highlights

AP-SAV100 Analog Voice Intercom IP Gateway

Smart Analog Voice Intercom IP Gateway Solution

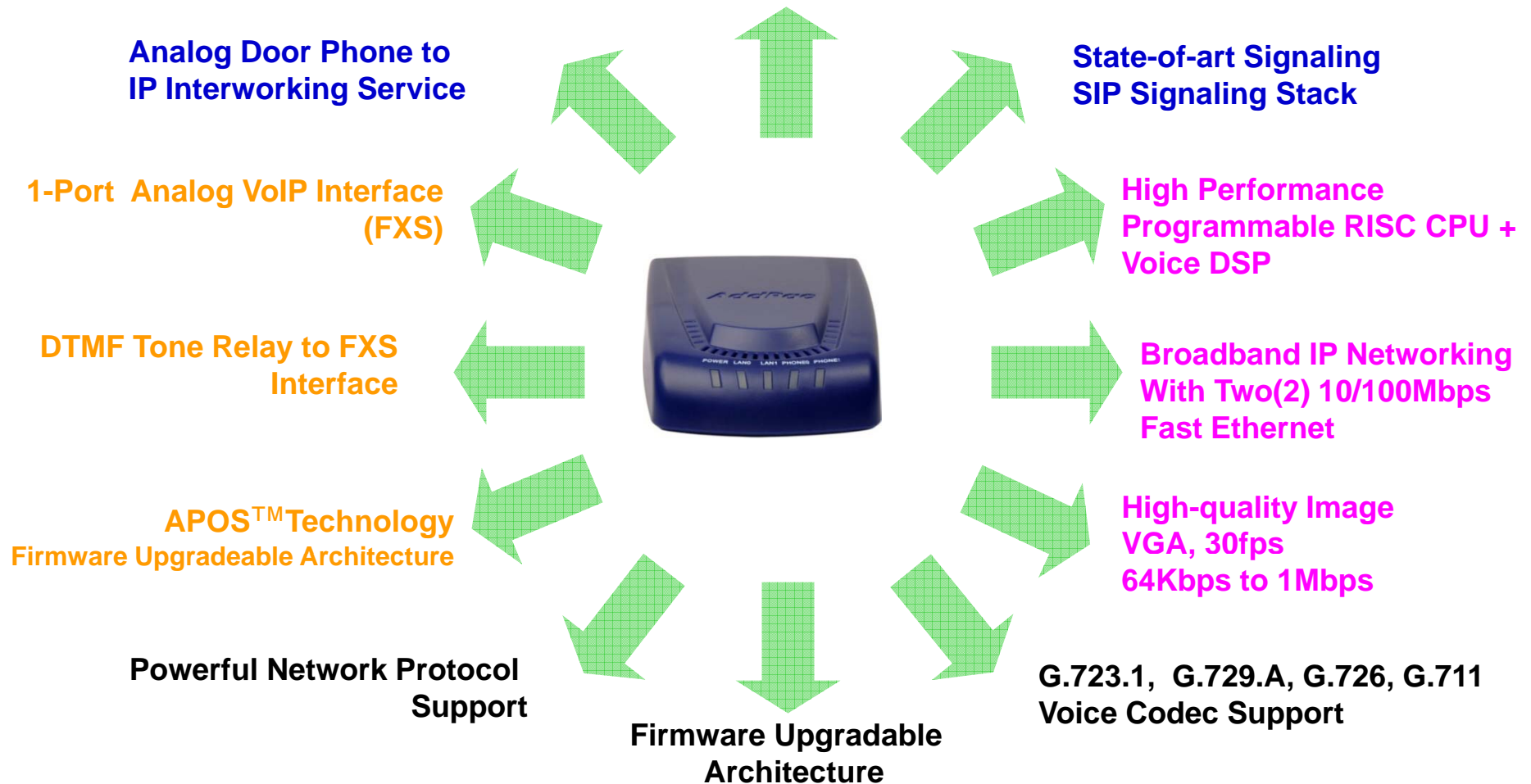

AddPac

www.addpac.com

APOS Technology

AP-SAV100 Analog Voice Intercom IP Gateway



- APOS : AddPac Internetworking Operating System
- OSD : On- Screen Display
- EMS : Element Management System

Hardware Specification

AP-SAV100 Analog Voice Intercom IP Gateway

RISC
CPU

- RISC Microprocessor Computing Power
- 1-Port FXS Analog VoIP Interface
- Network Interface
 - Two(2) 10/100Mbps Fast Ethernet (RJ45)
- Run LED, LAN LED, Port LEDs
- External Power Supply

Hardware Specification

AP-SAV100 Analog Voice Intercom IP Gateway

Analog Voice Intercom IP Gateway Service Diagram

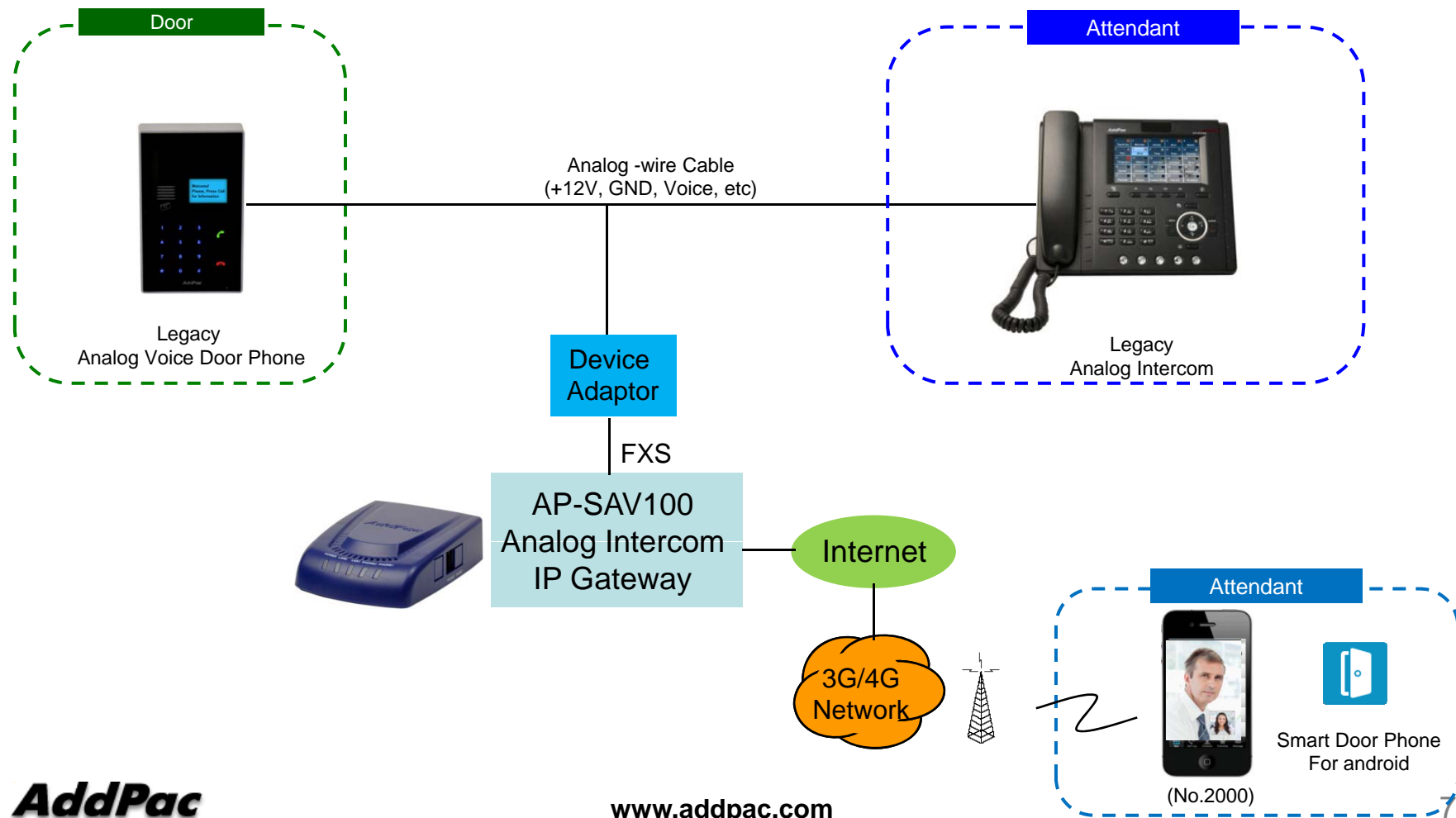

Hardware Specification

AP-SAV100 Analog Voice Intercom IP Gateway

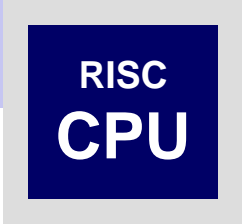

Analog Voice Intercom IP Gateway Service Diagram

AP-SAV100 Internal H/W Block Diagram

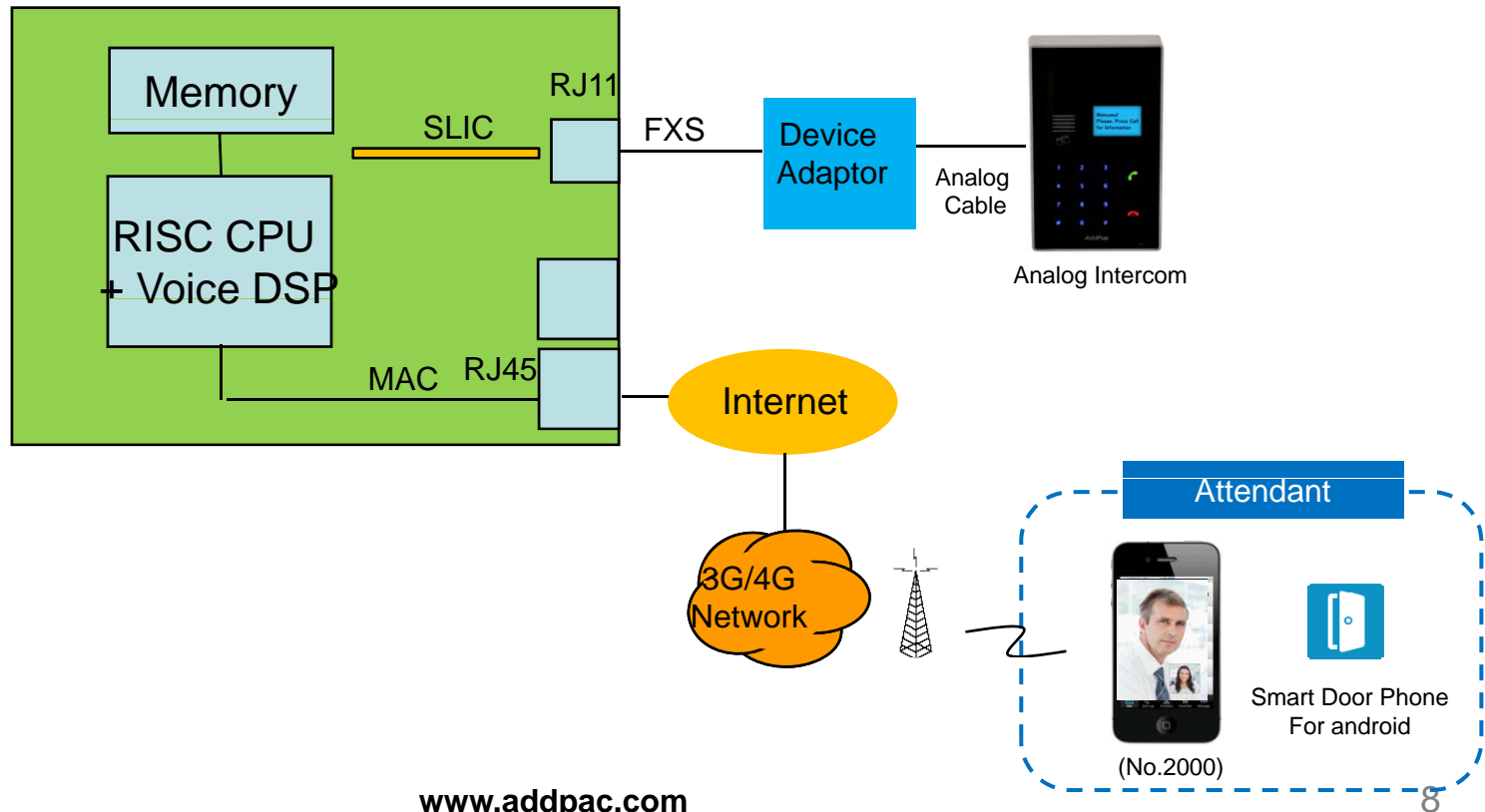

Hardware Specification

AP-SAV100 Analog Voice Intercom IP Gateway

Hardware Specifications

AP-SAV100 Model	Basic Specifications
CPU	32Bit RISC Microprocessor
Voice Interface	1-Port FXS Voice Interface(RJ-11)
Ethernet Interface	2-Ports 10/100Mbps Ethernet Interface(RJ-45)
Flash Memory	4Mbyte High-speed Flash Memory
Base Memory	16Mbyte High-speed SDRAM
Power Requirement	External Power Supply Adaptor / VAC 110~220V, 50/60Hz, 10Watt
Operating Temperature	0°C ~ 45°C (32 °F ~ 122°F)
Storage Temperature	-40°C ~ 85°C (-40°C ~ 185°F)
Relative Humidity	5% ~ 95% (Non-condensing)
Dimensions	28.8mm x 77mm x 111mm (H x W x D)

Network interface Configurations



VoIP (Voice over IP) Service

AP-SAV100 Analog Voice Intercom IP Gateway

- **H.323, SIP Dual Stack**
- **H.323**
 - ITU-T Standard H.323 v3 Support
 - Support H.245 Tunneling
 - Including H.235 Security Features
- **SIP**
 - IETF RFC3261 or RFC2543 SIP Standard

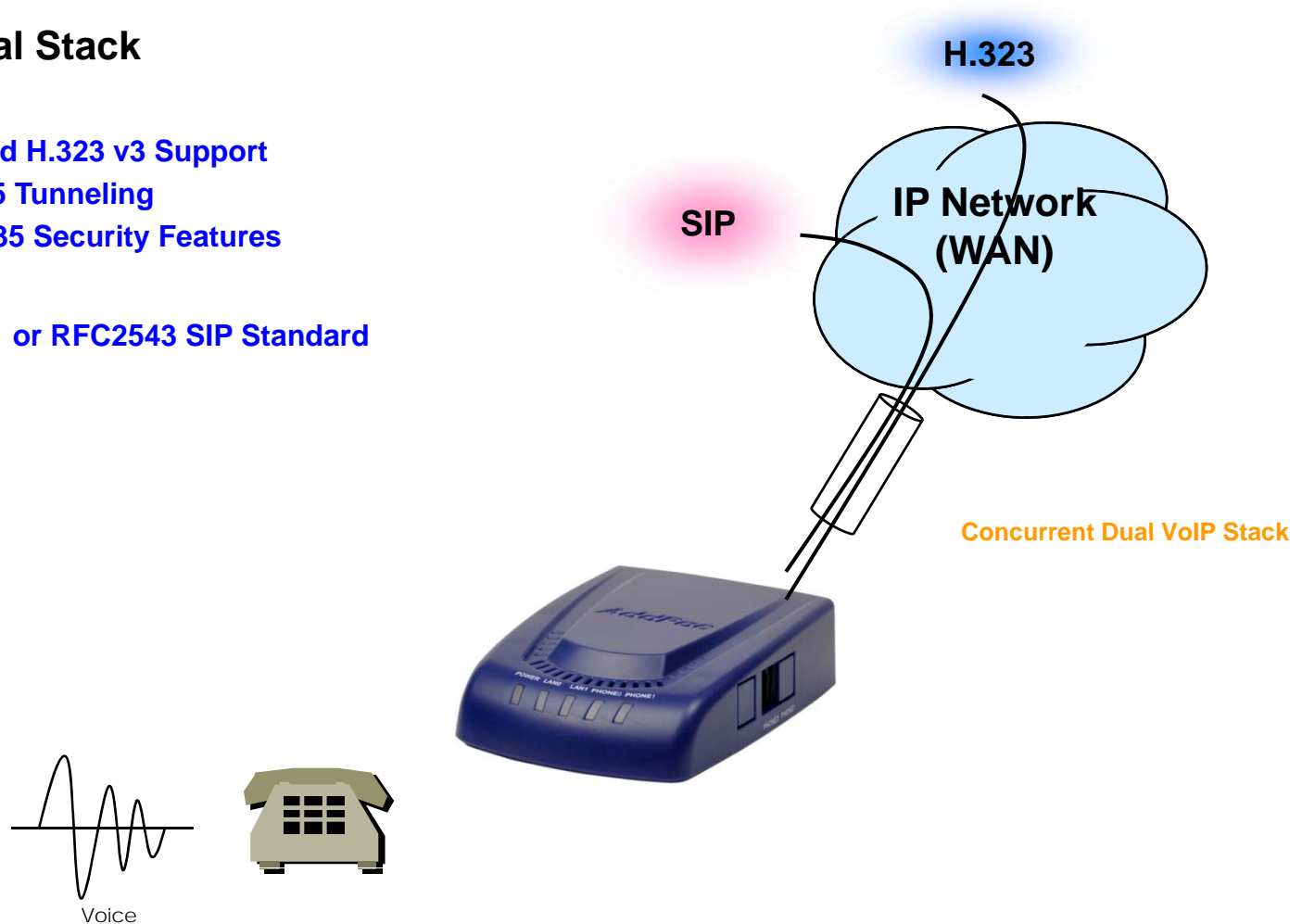

VoIP (Voice over IP) Service

AP-SAV100 Analog Voice Intercom IP Gateway

- **H.323**

- Fast connect, normal connect support
- H.245 tunneling support
- Q.931 response message setting for inbound VoIP calls
- H.245 logical channel open timing selection function
- Start H.245 procedure support
- DTMF / Hook flash relay with H.245 alphanumeric / signal
- Secondary gatekeeper support
- Gatekeeper assignment according to the domain name
- Gatekeeper discovery with multicast
- Lightweight RRQ support
- Signaling TCP port assignment
- Resource threshold setting with RAI
- H.235 clear-token, crypto-token support
- canMapAlias support
- Technical prefix (supported prefix) support
- Public IP assignment in NAT environment

- **SIP**

- Gateway-based / Endpoint-based registration support
- Secondary proxy-server assignment function
- SIP signaling port change function
- SIP proxy server assignment according to the domain name
- T.38 real-time fax relay support
- DTMF relay support with RFC2833 / OPTION message
- Re-INVITE support

VoIP (Voice over IP) Service

AP-SAV100 Analog Voice Intercom IP Gateway

- **Voice Codec**

- G.711 A-Law, G.711 U-Law
- G.726 r16, G.726 r32
- G.729A
- G.723.1 r63, G.723.1 r53
- VAD (Voice Activity Detection) function support
- DTMF relay support (H.323, SIP, MGCP common) based on RFC2833

- **RTP**

- Redundant RTP packet transmission in case of severe packet loss
- Dynamic jitter buffer management and RTP packet jitter and loss compensation with heuristic & DSP error concealment
- Static jitter buffer setting support
- Voice frame per RTP packet number control for each codec
- In-band ring-back tone support
- Virtual ring-back tone support
- Tone parameter change support

- **FAX**

- Fax relay mode supporting T.38, inband-T.38, bypass mode
- Lost packet compensation with redundant setting in case of T.38 fax relay
- Fax relay mode, rate setting for remote end

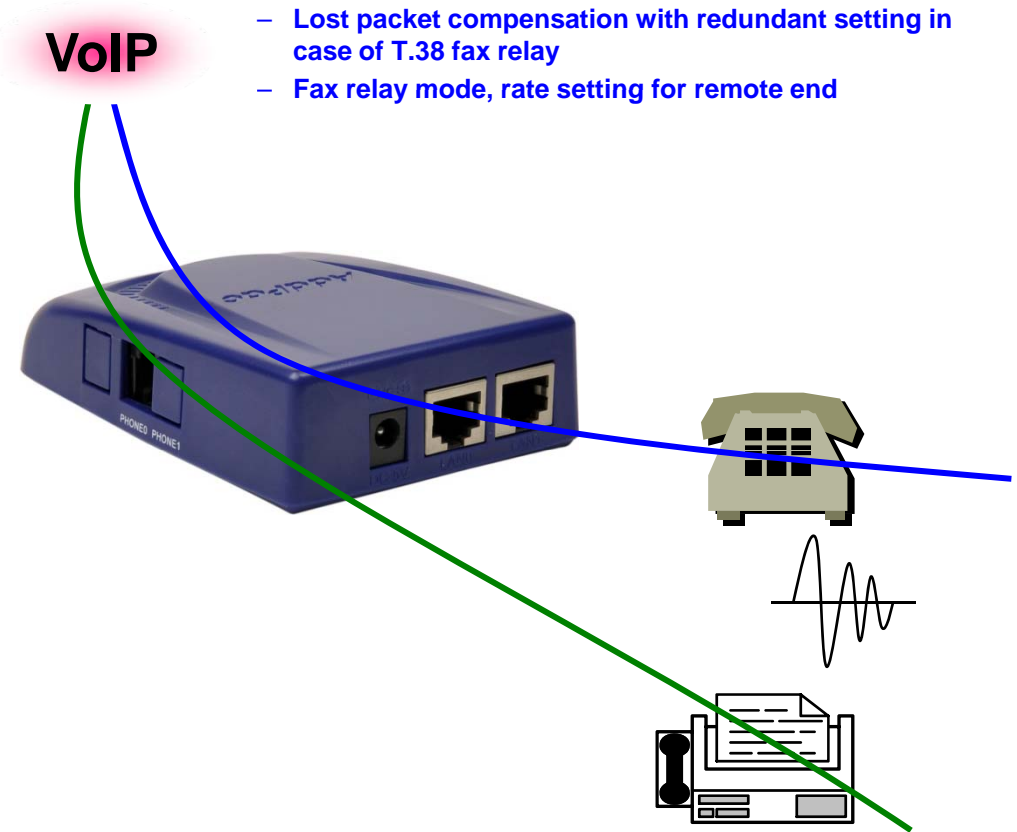

VoIP (Voice over IP) Service

AP-SAV100 Analog Voice Intercom IP Gateway

• VoIP Call Controls

- Hot line connection function with PLAR (Private Line Auto Ring Down)
- Leased line emulation function
- Connection monitoring function
- Fault tolerant with Redundancy and Call Distribution among Gateways for load balancing
- Call attempt with IP address
- H.323, SIP, MGCP inbound call connection for each voice port
- Multiple E.164 setting for one voice port
- One E.164 or digit pattern can be assigned to more than one voice port
- Hunting with Longest match/ priority/ sequence/ random
- One stage call setup by Digit forwarding
- Call barring with specific digit patterns
- Calling and called number conversion for PSTN outbound calls
- PSTN rerouting in case of VoIP call attempt failure

• VoIP Call Controls (cont.)

- Call transfer for internal calls
- Call pickup for internal calls
- Calling and called number conversion for VoIP outbound calls
- Calling and called number conversion for VoIP inbound calls
- Fax broadcasting call control

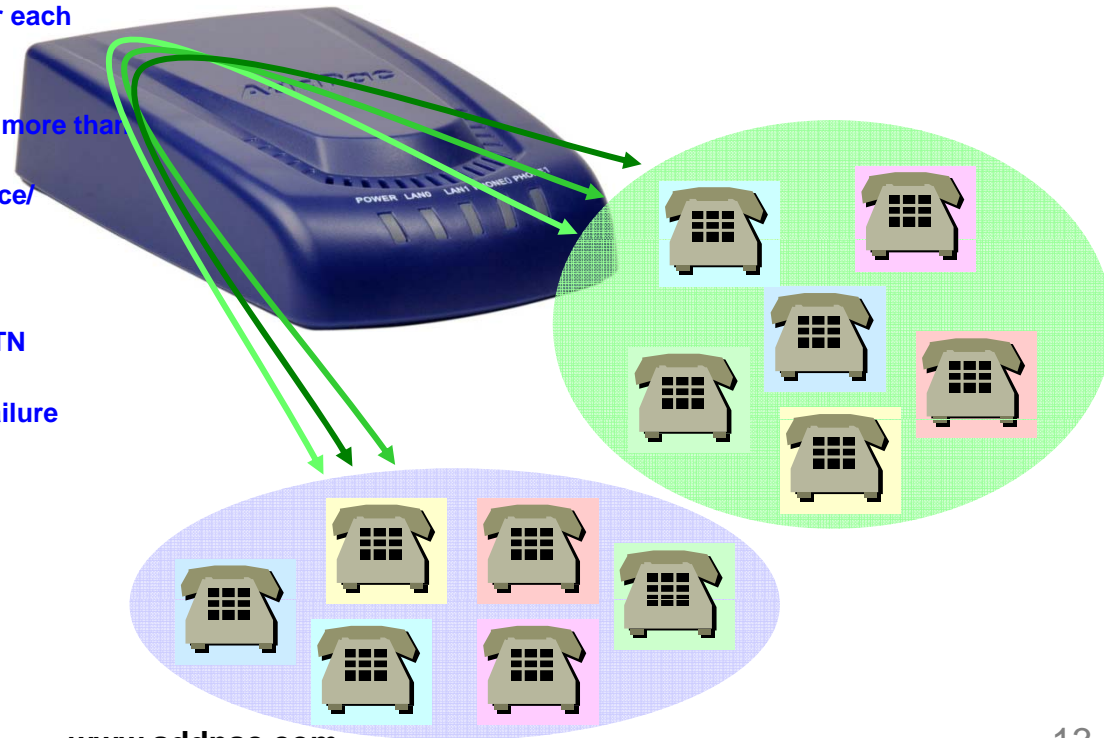

Network Protocols

AP-SAV100 Analog Voice Intercom IP Gateway

Basic Network Protocols

- ARP, IPv4, TCP, UDP, ICMP, SCTP, IGMP, MLD

Routing Protocol

- IPv4 : Static

Service Protocol

- FTP, Telnet, TFTP, DHCP Server/Relay, SNMP Server
- CDP (Cisco Discovery Protocol)
- DNS Resolver , DDNS(nsupdate)
- Bridge
- Syslog

IPv4 Address Configuration

- Fixed (Static)
- DHCP
- PPPoE

Miscellaneous

- Cisco Style CLI
- Standard & Extended IPv4 Access List
- Multi-level User Account Management
- IP accounting
- STUN Client

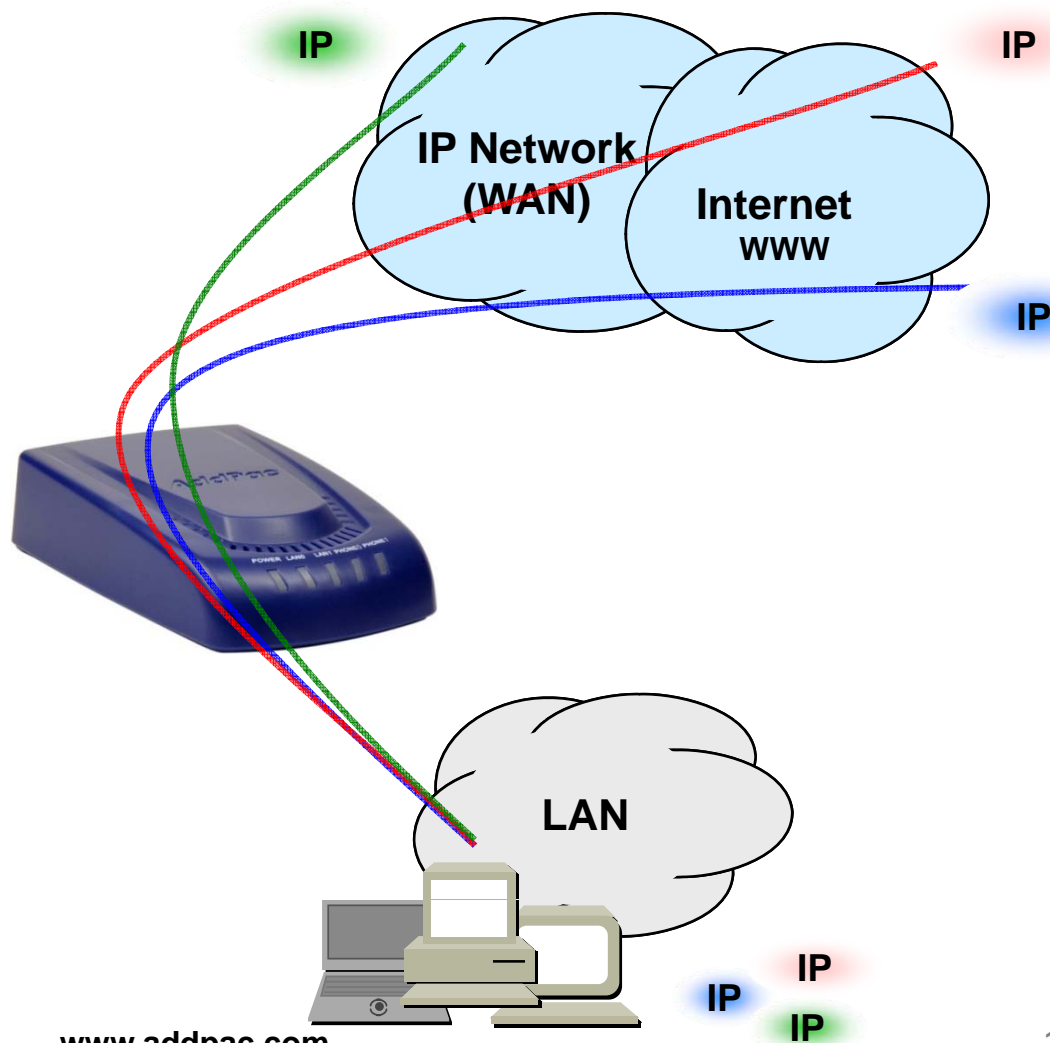

Network Management

AP-SAV100 Analog Voice Intercom IP Gateway

- **SNMP**

- Standard Simple Network Management Protocol(SNMP) Agent support
- MIB v1 and v2 Support

- **Web-based Management**

- Smart Easy Setup
- Standard Voice Interface
- Standard PSTN Back-up Interface

- **Watch-dog Function**

- Hardware, Software watch-dog services

- **Remote Management**

- Telnet
- Rlogin

- **Auto Upgrade Service**

- HTTP server based APOS image and configuration file auto-upgrade support

- **Batch Job Function**

- Text based script downloading

- **Interoperable with AP-SNMS Service**

- AddPac Smart Network Management System (AP-SNMS)

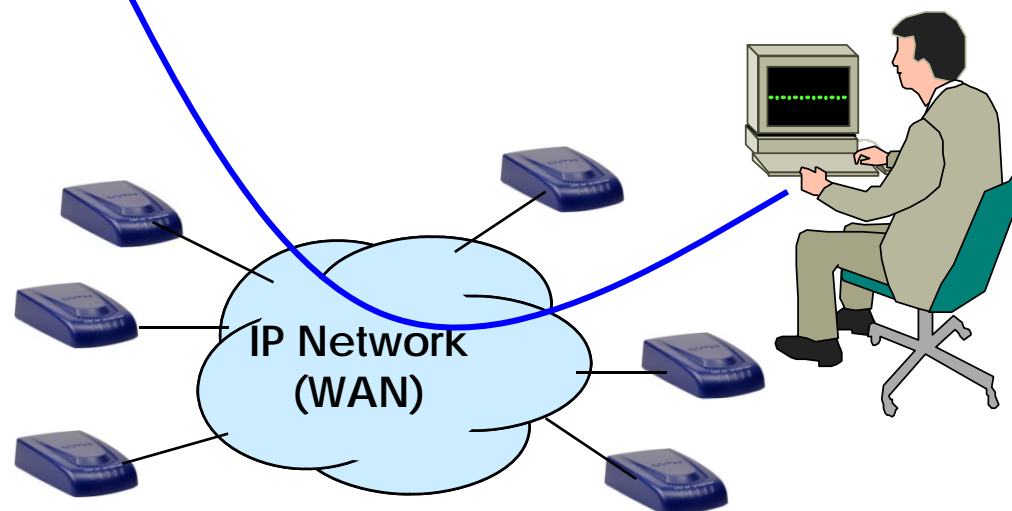

Security Management

AP-SAV100 Analog Voice Intercom IP Gateway

- IP packet filtering
- IP access list
- User authentication function
 - Password Authentication Protocol (PAP)
 - Challenge Handshake Authentication Protocol (CHAP)
- Enable/Disable specific protocols
- Auto-square connect of Telnet session
- Account Management function for multi-level user
- SNMP/TELNET/FTP/HTTP/TFTP port assignment function
- SNMP/TELNET/FTP access list management
- Boot mode security checking function

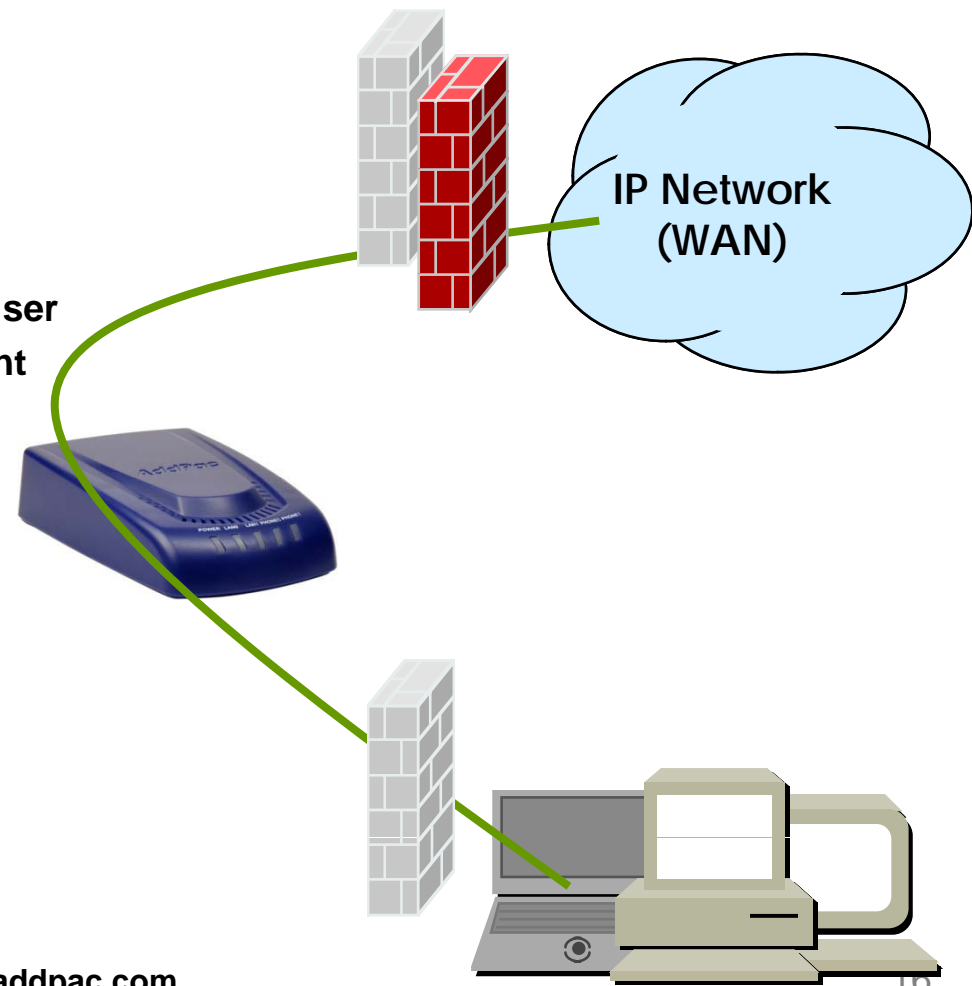

Standard Application

AP-SAV100 Analog Voice Intercom IP Gateway

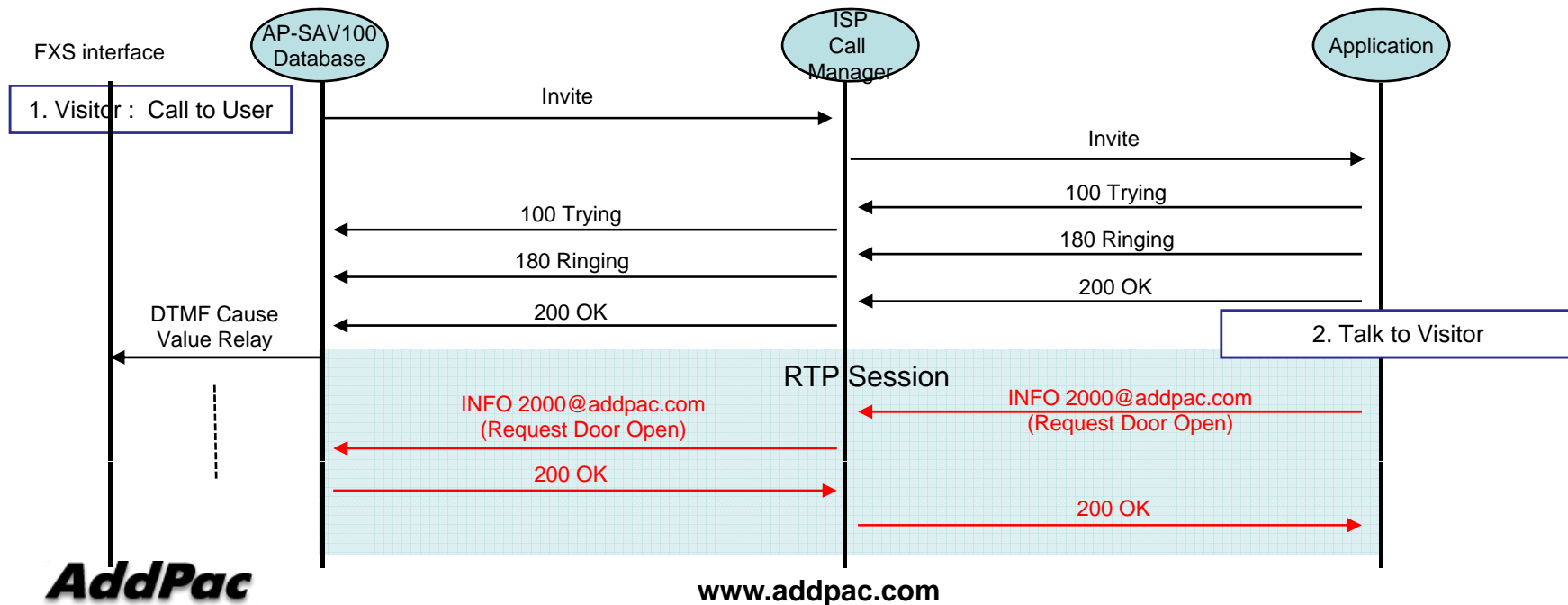
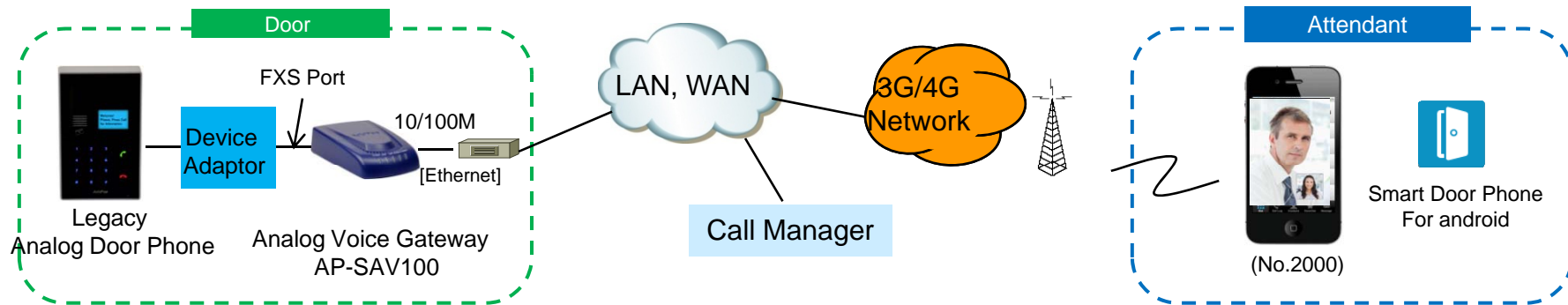

Ordering Information

- **AP-SAV100 Smart Analog Voice Intercom IP Gateway Hardware**
 - AP-SAV100 Main Body
 - RISC Microprocessor
 - 1-Port FXS Analog VoIP Interface
 - 2-Port 10/100Mbps Fast Ethernet(2xRJ45)
 - Including Network Cable & Ext. Power Supply, etc.
- **Built-in APOS Internetworking Software for AP-SAV100**
- **Including 1 Year Hardware Warranty**
- **Product Documents**
 - Install and Operation Guide (PDF)
- **Pricing**
 - AddPac Technology Regional Sales Manager
 - Authorized Sales and Marketing Representatives
 - Please Contact www.addpac.com



Thank you!

AddPac Technology Co., Ltd.
Sales and Marketing

Phone +82.2.568.3848 (KOREA)

FAX +82.2.568.3847 (KOREA)

E-mail sales@addpac.com