

Emergency Call IP Phone Call Center Solution



Secure Zone Scheme for Hacking Protection



AddPac

AddPac Technology

Sales and Marketing

Contents

- Emergency Call IP Phone Service Diagram
 - Single Network Diagram
 - Network Separation through Secure Zone Scheme
 - Secure Zone Scheme (Analog FXS-FXO, Digital E1/T1)
- Emergency Call IP Phone Comparison Table
 - AP-EIP100
 - AP-EIP90
 - AP-EIP80
 - AP-EIP70
 - AP-EIP50
- IPNext600 IP-PBX Solution for Call Center
- IP Phone Solution for Call Center
- AP1800 VoIP Gateway for Secure Zone Service

Emergency Call IP Phone Service Diagram - Single Network

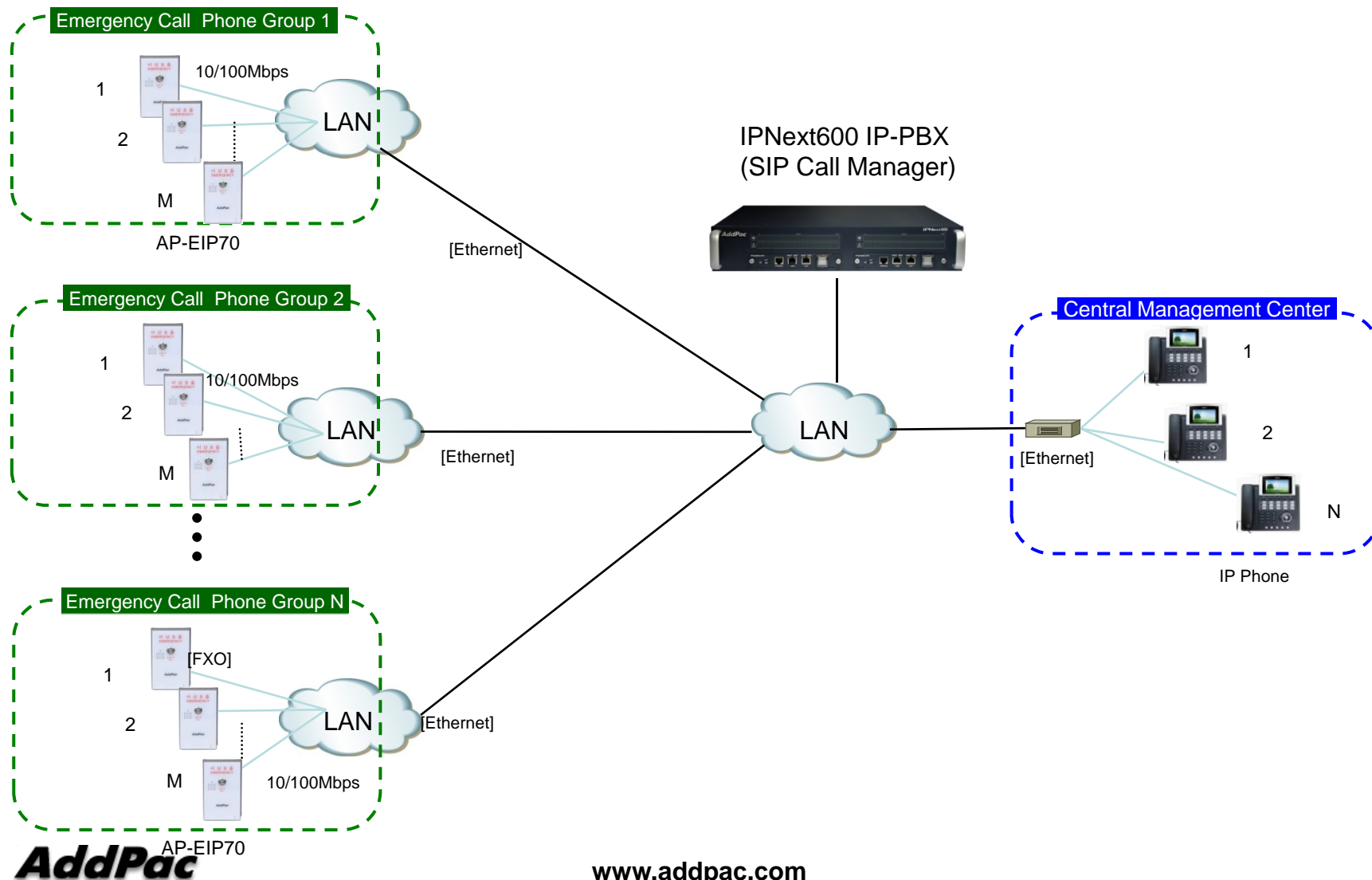



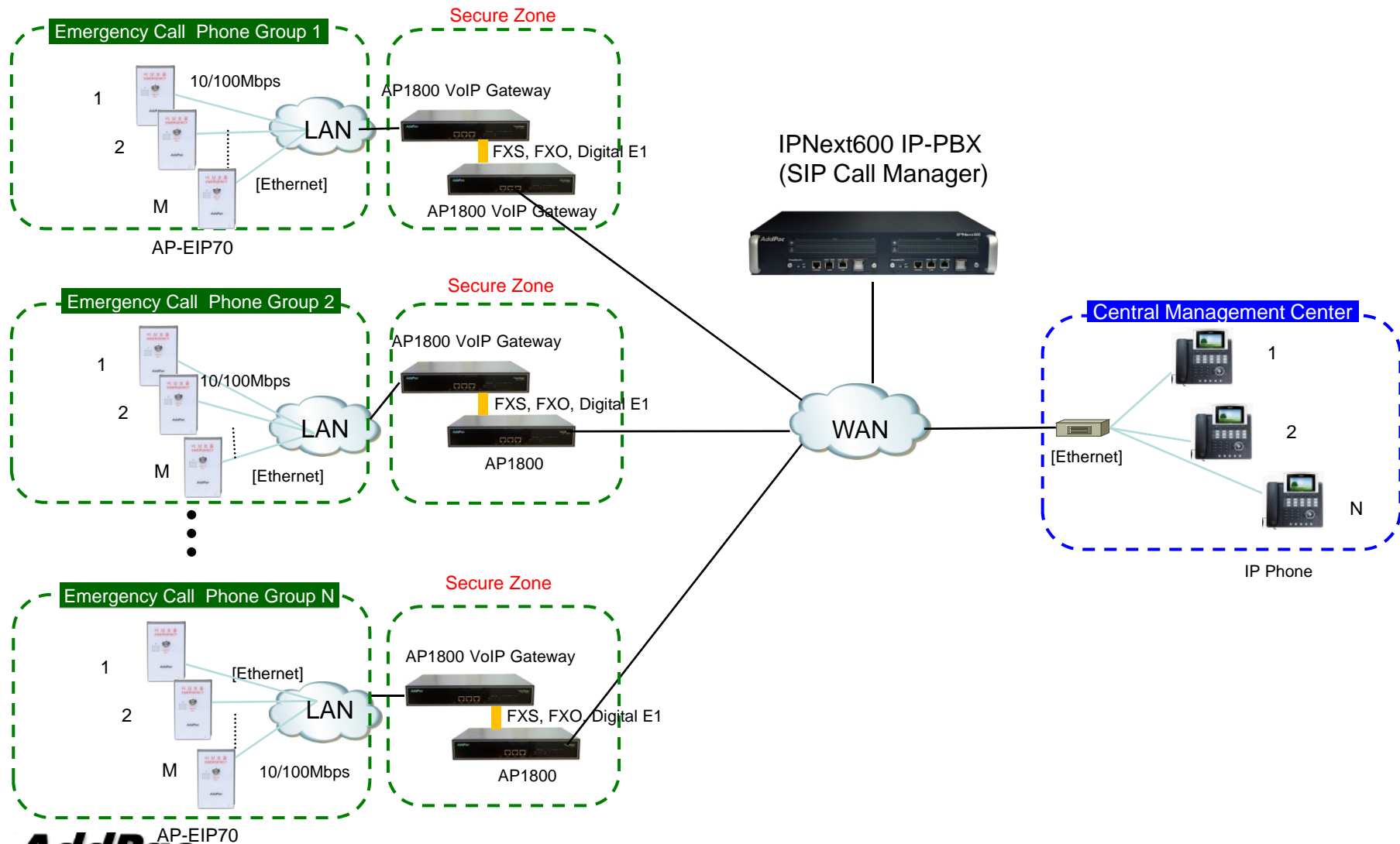

Emergency Call IP Phone Service Diagram - Dual Network Separation through Secure Zone

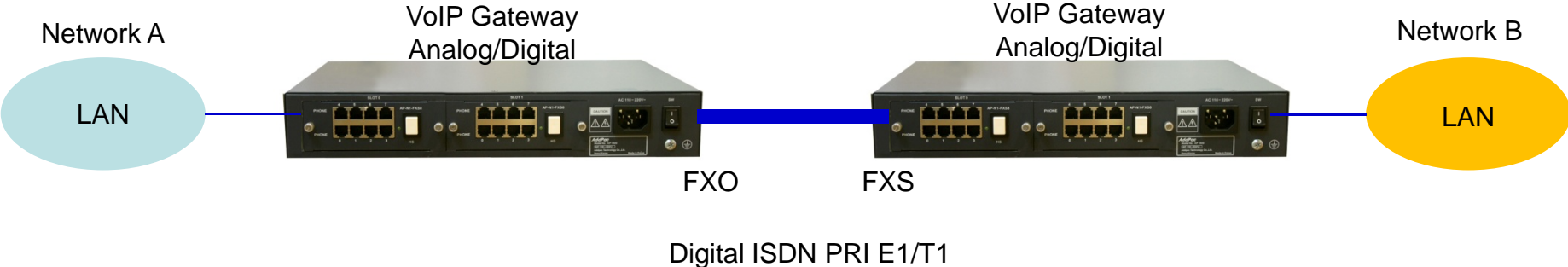

Secure Zone Scheme



Emergency Call IP Phone Comparison Table

Model	AP-EIP100	AP-EIP90	AP-EIP80	AP-EIP70	AP-EIP50
Service Features					
Duplex	Full Duplex	Full Duplex	Full Duplex	Full Duplex	Full Duplex
Key Pad	3x4 Key Support	N/A	N/A	N/A	N/A
Handset	Support	N/A	N/A	N/A	N/A
Voice Codec	G.711/G.726/ G.729/G.723	G.711/G.726/ G.729/G.723	G.711/G.726/ G.729/G.723	G.711/G.726/ G.729/G.723	G.711/G.726/ G.729/G.723
Signaling	H.323/SIP	H.323/SIP	H.323/SIP	H.323/SIP	H.323/SIP
Speaker Phone	Support	Support	Support	Support	Support
LAN Port	1	1	1	1	1
PoE(Optional)	Support	Support	Support	Support	Support
Application	Indoor	Outdoor(water proof)	Outdoor(water proof)	Outdoor(water proof)	Indoor



IP-PBX Solution for Call Center



IPNext600 IP-PBX Solution for Call Center

Network Diagram

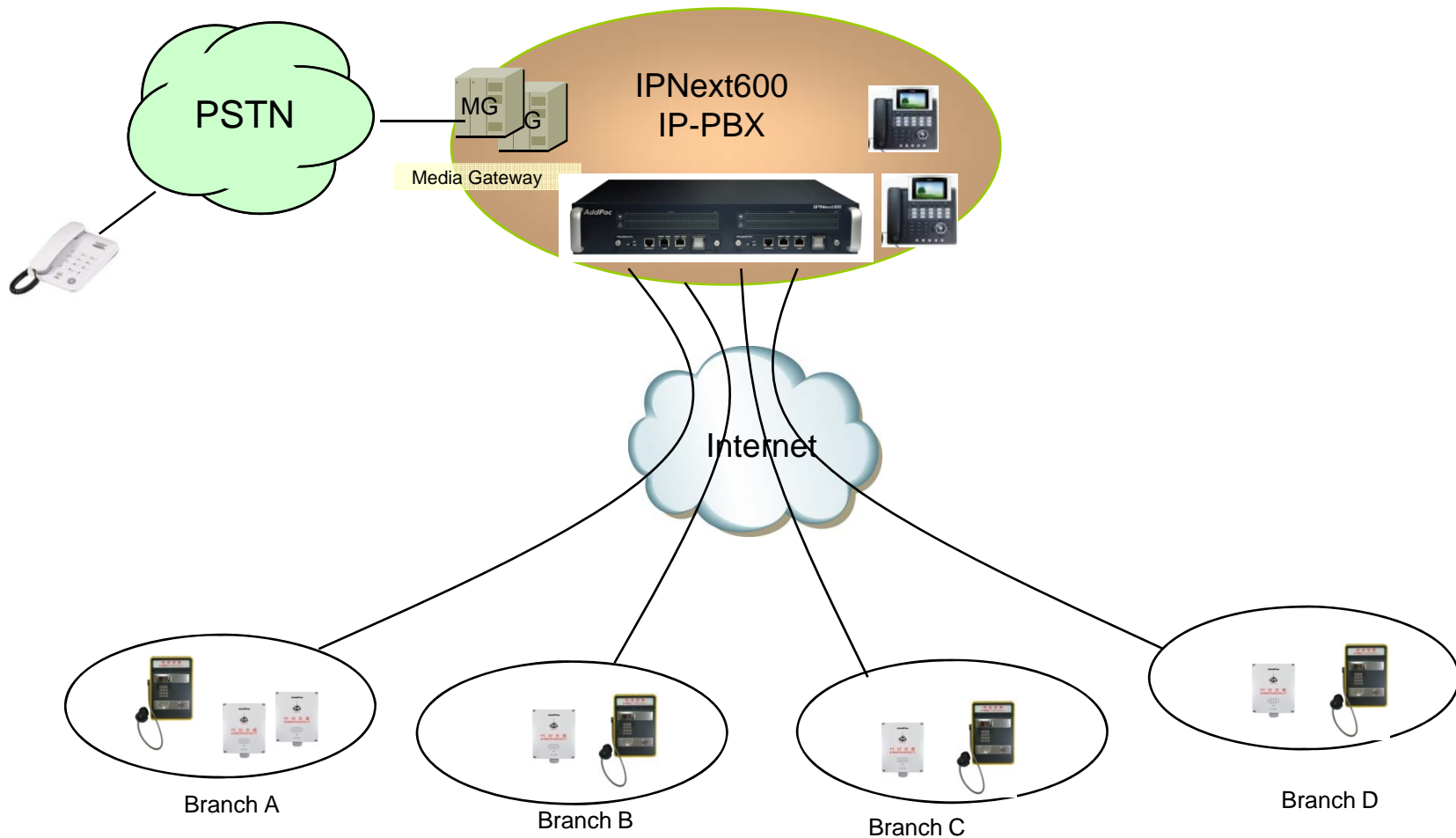

Product Overview

IPNext 600 Next Generation IP-PBX System

- SIP Application Server, Proxy, Registrar and Location Server
- Multiple ITSP Trunk with SIP & H.323 Accounts Support
- Dual System Redundancy Architecture
 - Two(2) Fast Ethernet Interface / System
- High Performance RISC Architecture
- Powerful Network Protocols (PPPoE, DHCP, Static Routing, etc)
- IPv4/IPv6 Dual Stack
- RTP Proxy Function Embedded for Private IP and IPv6 Address Interworking
- User Presence Service Features for Smart Multimedia Messenger and Smart IP Phone
- IVR Scenario Editor, Voice Mail, Media Service (Coloring), Conference
- Firmware Upgradeable Architecture
- Smart Multimedia Manager for IP-PBX Management
- Smart Messenger Service (click to dial) for Unified Communication
- Smart NMS for Large Scale Deployment
- Advanced Voice QoS Mechanism
- Dual Redundancy Power Module

Hardware Specification

IPNext 600 Next Generation IP-PBX System

RISC
CPU

IPNext 600 Front Side

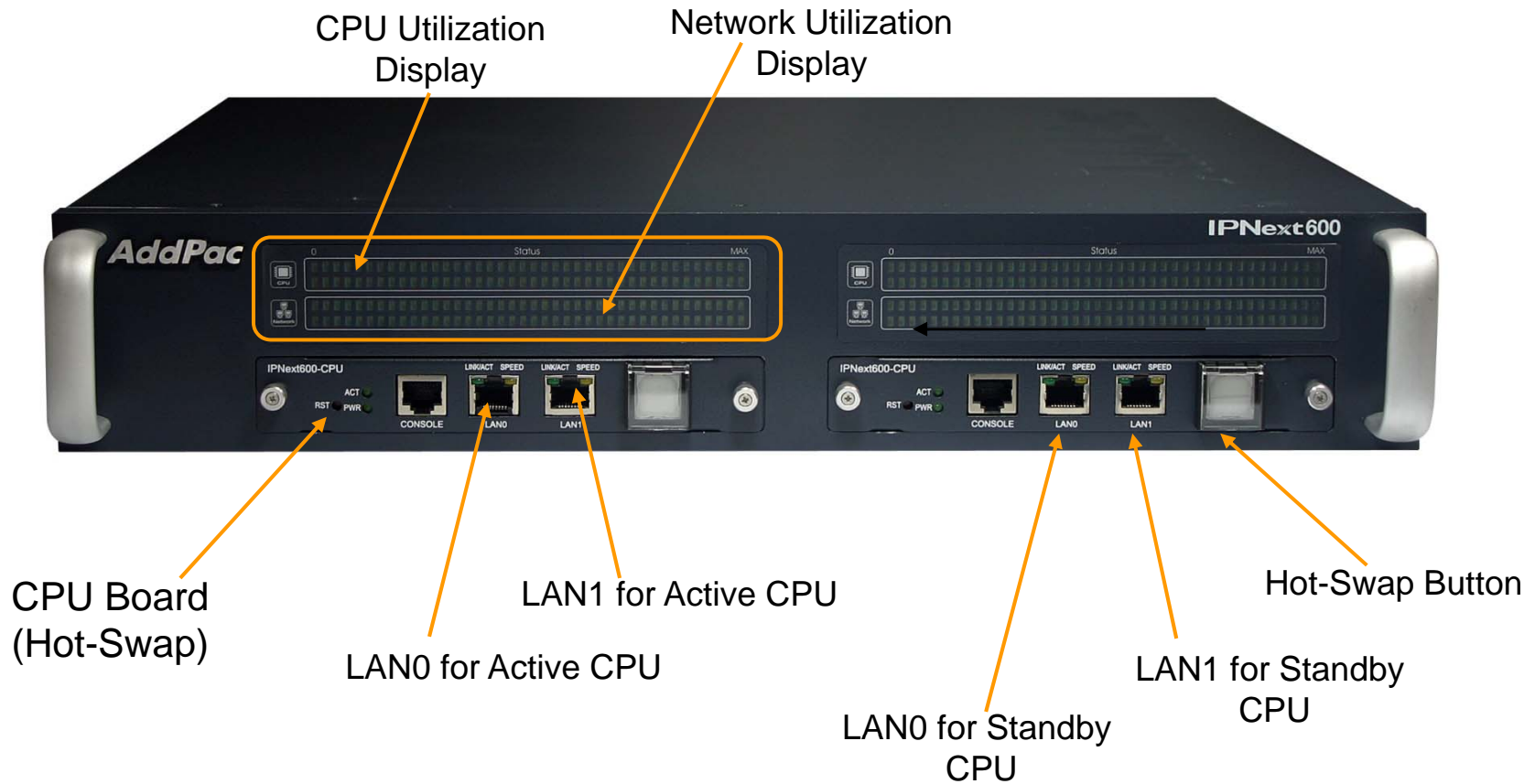

Hardware Specification

IPNext 600 Next Generation IP-PBX System



IPNext 600 Back Side

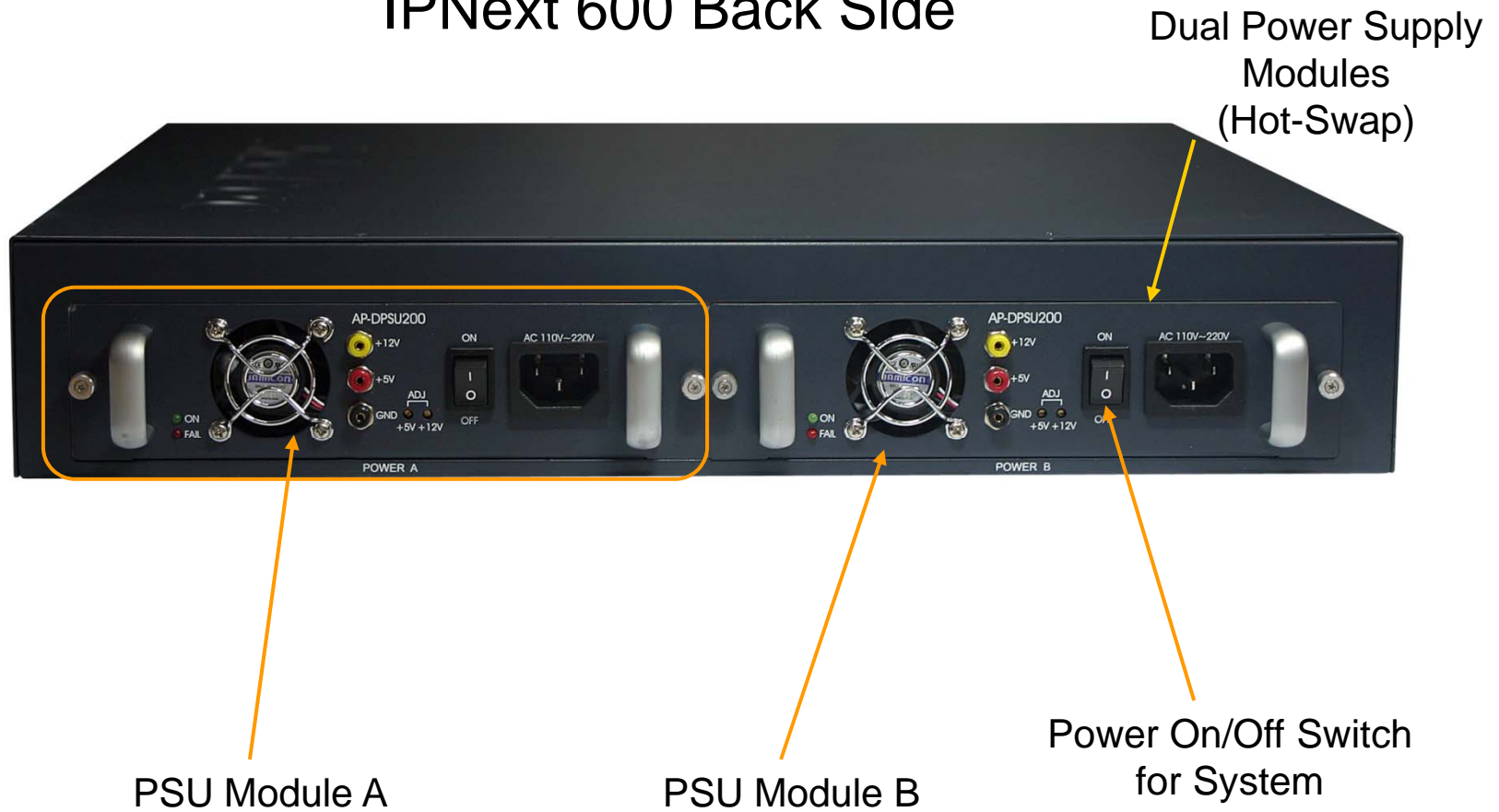

System Redundancy Features

IPNext 600 Next Generation IP-PBX System

IPNext600 System Block Diagram

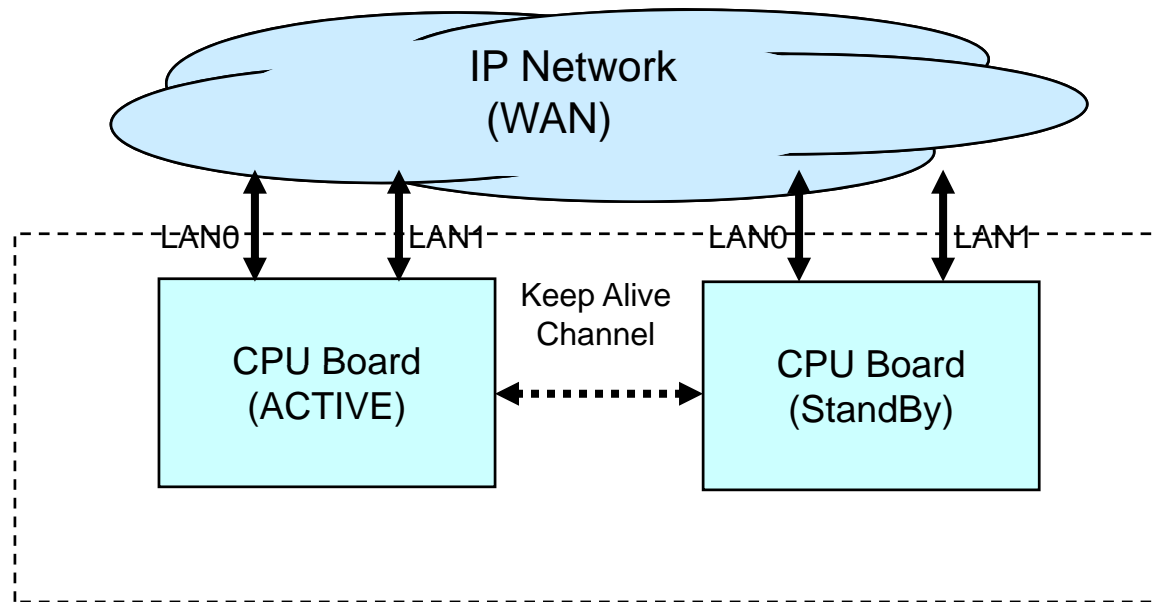

System Redundancy Features

IPNext 600 Next Generation IP-PBX System

- Active– Active Duplication Scheme
- Active – Standby Duplication Scheme
- VRRP based Duplication Scheme

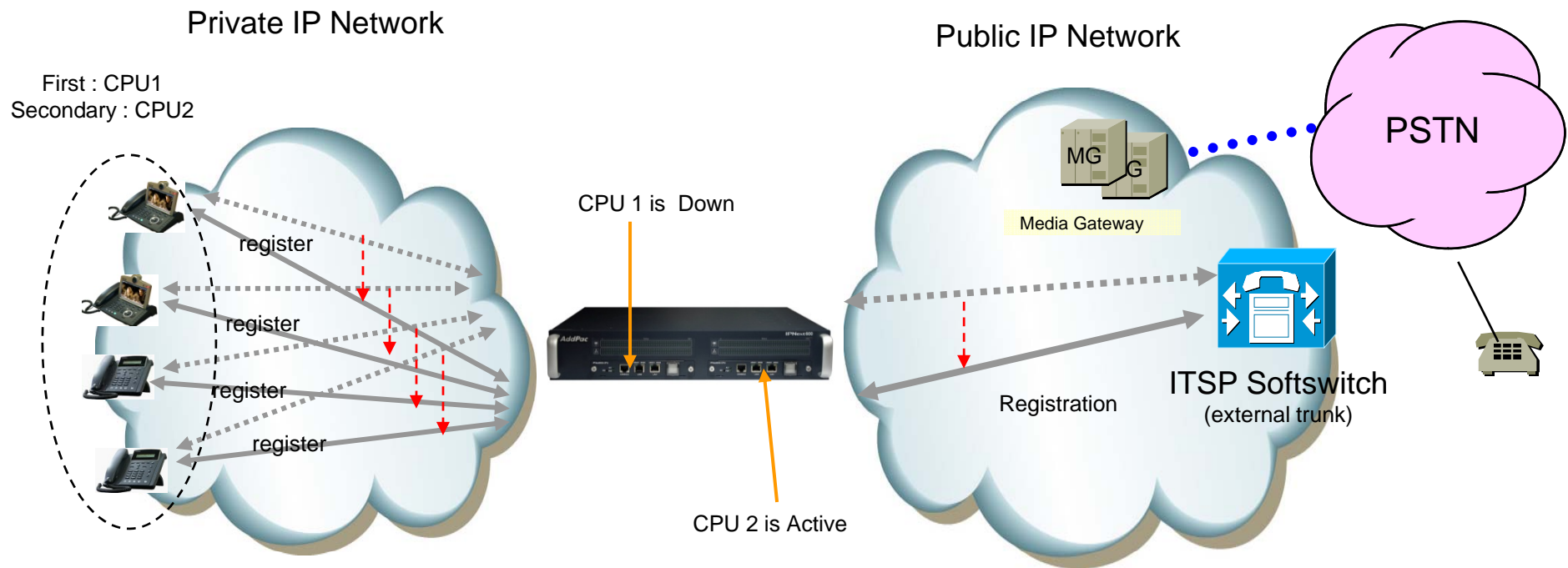

Active – Standby Duplication Scheme (example)



IP Phone Solution for Call Center

IP Phone Comparison Table

	AP-IP300	AP-IP230
		
LCD Size	4.3 Inch Color LCD	5 Inch Color LCD
Touch Screen	N/A	Support
Speed-Dial Keys	25 Key with Presence LED	Touch Screen based 25 Keys
Voice Codec	G.711/G.726/ G.729/G.723	G.711/G.726/ G.729/G.723
Signaling	H.323/SIP	H.323/SIP
3-Party Conversation	Support	Support
LAN Port	2	2
PoE(Optional)	Support	Support
FXO(Optional)	Support	Support



AP1800 VoIP Gateway

Product Overview

AP1800 Analog/Digital VoIP Gateway

- H.323/SIP/MGCP Triple Concurrent Stack Embedded
- High Performance RISC & Programmable DSP Architecture
- Analog/Digital VoIP Gateway Solution
- Various Analog Interface Support : FXS, FXO, E&M
- Digital E1/T1 Interface Support : ISDN-PRI, MFCR2, etc
- Two(2) 10/100Mbps Fast Ethernet (IP Share ,etc)
- High Performance LAN-to-LAN Routing Capability
- G.711/G.726/G.723/G.729, T.38 Fax , VAD, etc
- Powerful Network Protocols (PPPoE, DHCP, Static Routing, etc)
- Firmware Upgradeable Architecture
- VPMS (VoIP Plug&Play Management System) for Large Scale Deployment
- Advanced Voice QoS Mechanism
- Light and Compact Design with Internal Power Supply
- Two(2) VoIP Module Slot
- Hot-Swap Function Support

Hardware Specification

AP1800 Analog/Digital VoIP Gateway

RISC
CPU

High-end
DSP

- RISC Microprocessor Computing Power
- Up to 16 Port Analog VoIP Gateway
- Two(2) VoIP Module Slots (Hot-Swap)
 - 8-Port FXS Card, 8-Port FXO Card, 4-Port FXS 4-Port FXO Card , Digital E1/T1 Card
- Network Interface
 - Two(2) 10/100Mbps Fast Ethernet (RJ45)
- RS232C Console Interface
- Run LED, LAN LED, Port LEDs
- Internal Power Supply

Hardware Specification

AP1800 Analog/Digital VoIP Gateway

Hardware Specifications

AP1800 VoIP Series	Basic Specifications
Voice Interface	Two(2) VoIP Module Slots AP-N1-FXS8, AP-N1-FXO8, AP-N1-FXS4O4, AP-N1-E1, etc
Ethernet Interface	2-Ports 10/100Mbps Ethernet Interface(RJ-45)
Flash Memory	4Mbyte High-speed Flash Memory
Base Memory	32 Mbyte High-speed SDRAM
Power Requirement	Power Supply Adaptor / VAC 110~220V, 50/60Hz,
Operating Temperature	0°C ~ 45°C (32 °F ~ 122°F)
Storage Temperature	-40°C ~ 85°C (-40°C ~ 185°F)
Relative Humidity	5% ~ 95% (Non-condensing)

Network interface Configurations

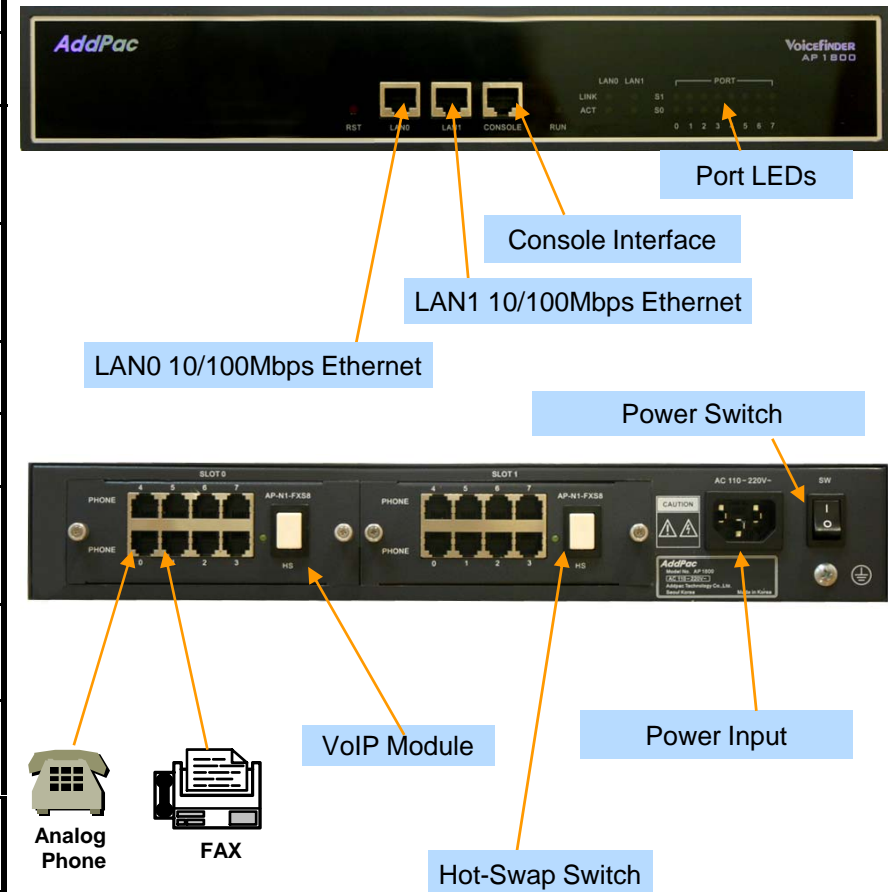



Thank you!

AddPac Technology Co., Ltd.
Sales and Marketing

Phone +82.2.568.3848 (KOREA)

FAX +82.2.568.3847 (KOREA)

E-mail : sales@addpac.com