

Emergency Call IP Phone Call Center Solution

Emergency Call IP Phone Call Center Solution

- AP-EIP100 Emergency IP Phone
- AP-EIP90 Emergency IP Phone
- AP-EIP70 Emergency IP Phone
- IPNext600 IP-PBX
- AP-IP300 IP Phone
- AP-NR5000 Network Recording Server
- Smart Digital Voice Recording Program
- Smart Network Management System

[Learn More >](#)

AddPac

AddPac Technology

Sales and Marketing

www.addpac.com

Contents

- Emergency Call IP Phone Call Center Network Diagram
- Emergency Call IP Phone Comparison Table
 - AP-EIP100
 - AP-EIP90
 - AP-EIP80
 - AP-EIP70
 - AP-EIP50
- IPNext600 IP-PBX Solution for Call Center
- IP Phone Solution for Call Center
- Smart Attendant Console Solution for Call Center
- IP Voice Recording Solution
- Smart NMS Solution for IP Terminal Management



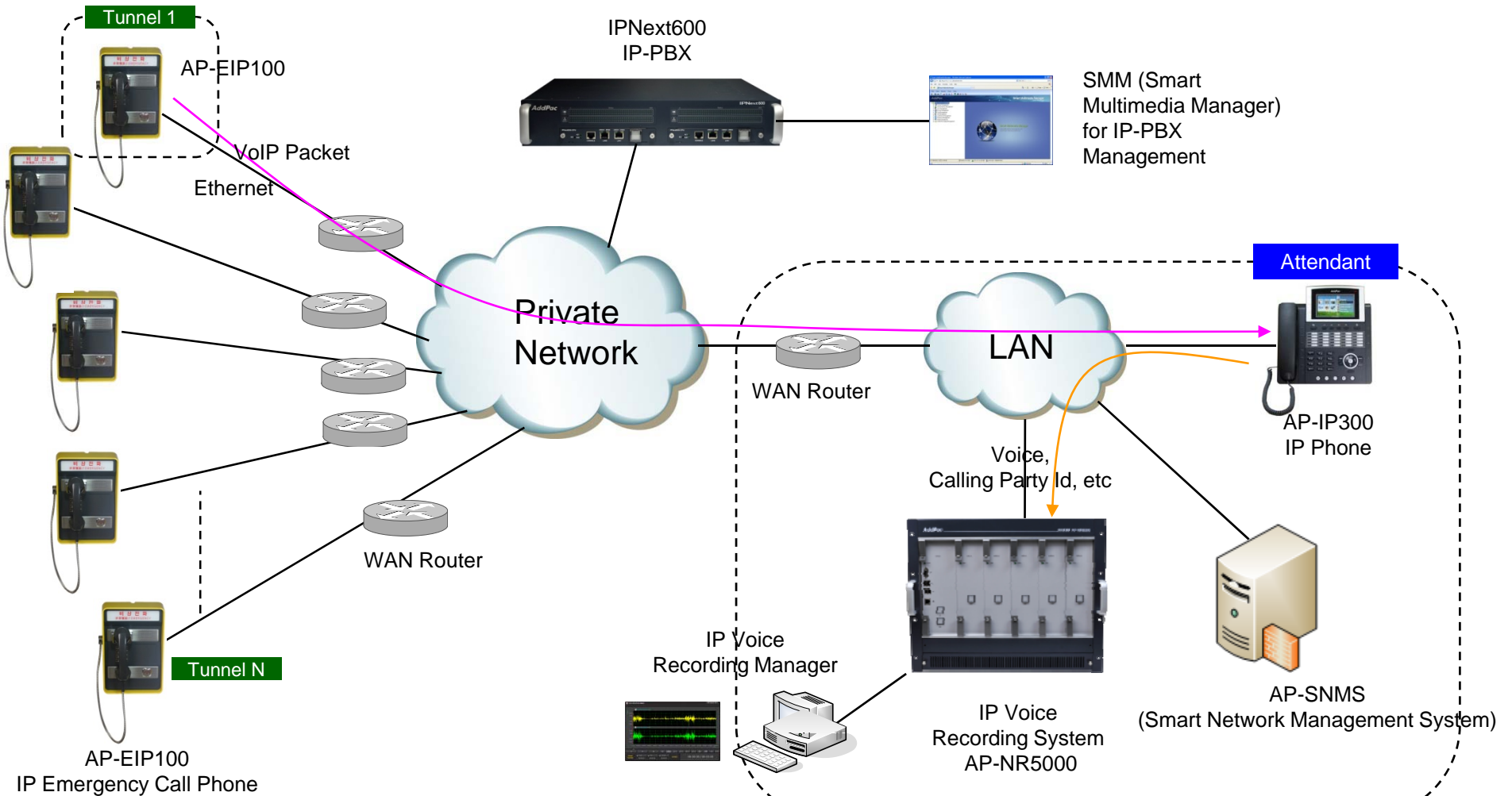

Network Diagram





Emergency Call IP Phone Solution

Emergency Call IP Phone Comparison Table

Model	AP-EIP100	AP-EIP90	AP-EIP80	AP-EIP70	AP-EIP50
Service Features					
Duplex	Full Duplex	Full Duplex	Full Duplex	Full Duplex	Full Duplex
Key Pad	3x4 Key Support	N/A	N/A	N/A	N/A
Handset	Support	N/A	N/A	N/A	N/A
Voice Codec	G.711/G.726/ G.729/G.723	G.711/G.726/ G.729/G.723	G.711/G.726/ G.729/G.723	G.711/G.726/ G.729/G.723	G.711/G.726/ G.729/G.723
Signaling	SIP	SIP	SIP	SIP	SIP
Speaker Phone	Support	Support	Support	Support	Support
LAN Port	1	1	1	1	1
PoE(Optional)	Support	Support	Support	Support	Support
Application	Indoor	Outdoor(water resistance)	Outdoor(water resistance)	Outdoor(water resistance)	Indoor



IPNext600 IP-PBX Solution for Call Center

Network Diagram

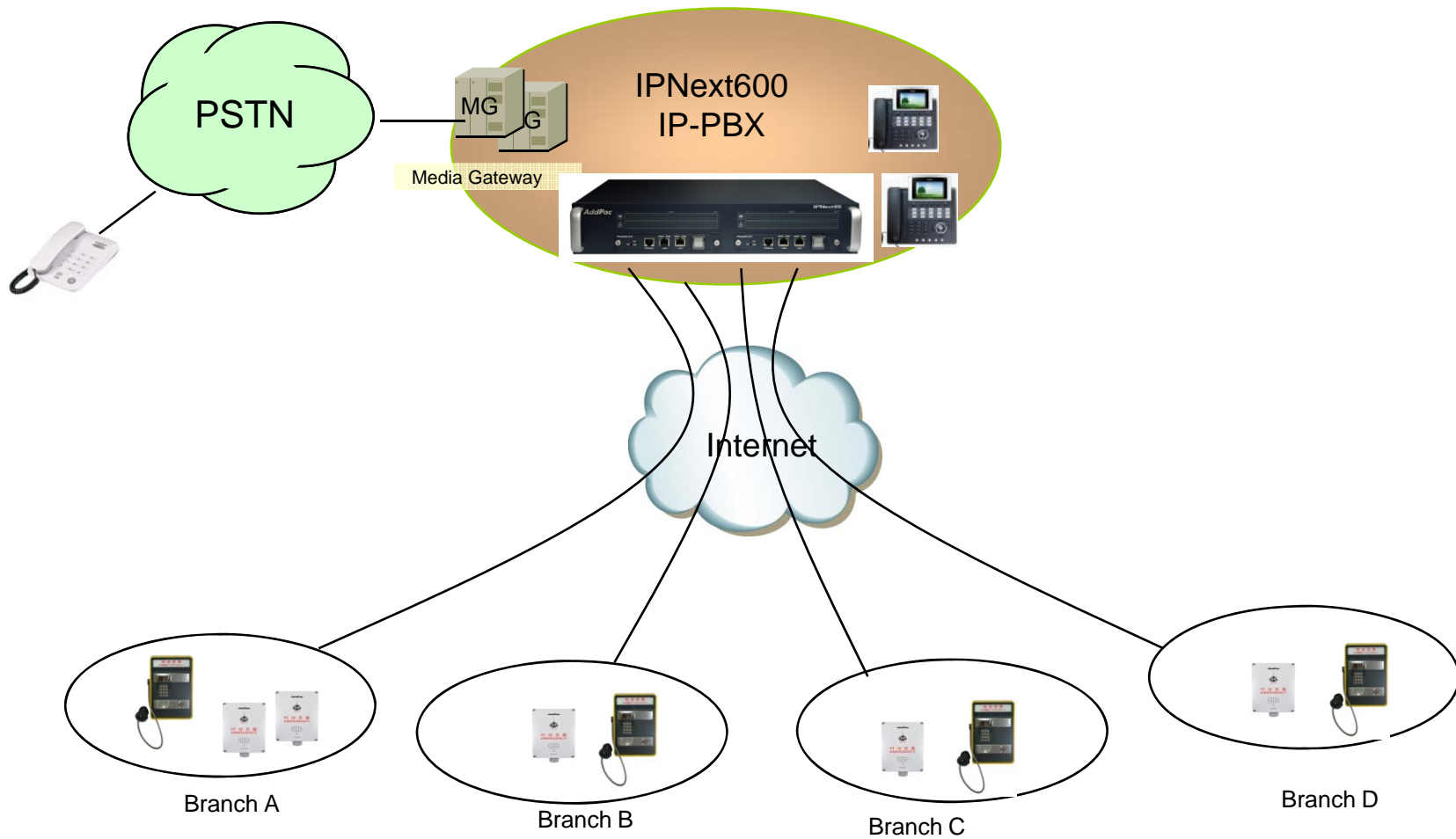

Product Overview

IPNext 600 Next Generation IP-PBX System

- SIP Application Server, Proxy, Registrar and Location Server
- Multiple ITSP Trunk with SIP & H.323 Accounts Support
- Dual System Redundancy Architecture
 - Two(2) Fast Ethernet Interface / System
- High Performance RISC Architecture
- Powerful Network Protocols (PPPoE, DHCP, Static Routing, etc)
- IPv4/IPv6 Dual Stack
- RTP Proxy Function Embedded for Private IP and IPv6 Address Interworking
- User Presence Service Features for Smart Multimedia Messenger and Smart IP Phone
- IVR Scenario Editor, Voice Mail, Media Service (Coloring), Conference
- Firmware Upgradeable Architecture
- Smart Multimedia Manager for IP-PBX Management
- Smart Messenger Service (click to dial) for Unified Communication
- Smart NMS for Large Scale Deployment
- Advanced Voice QoS Mechanism
- Dual Redundancy Power Module

Hardware Specification

IPNext 600 Next Generation IP-PBX System

RISC
CPU

IPNext 600 Front Side

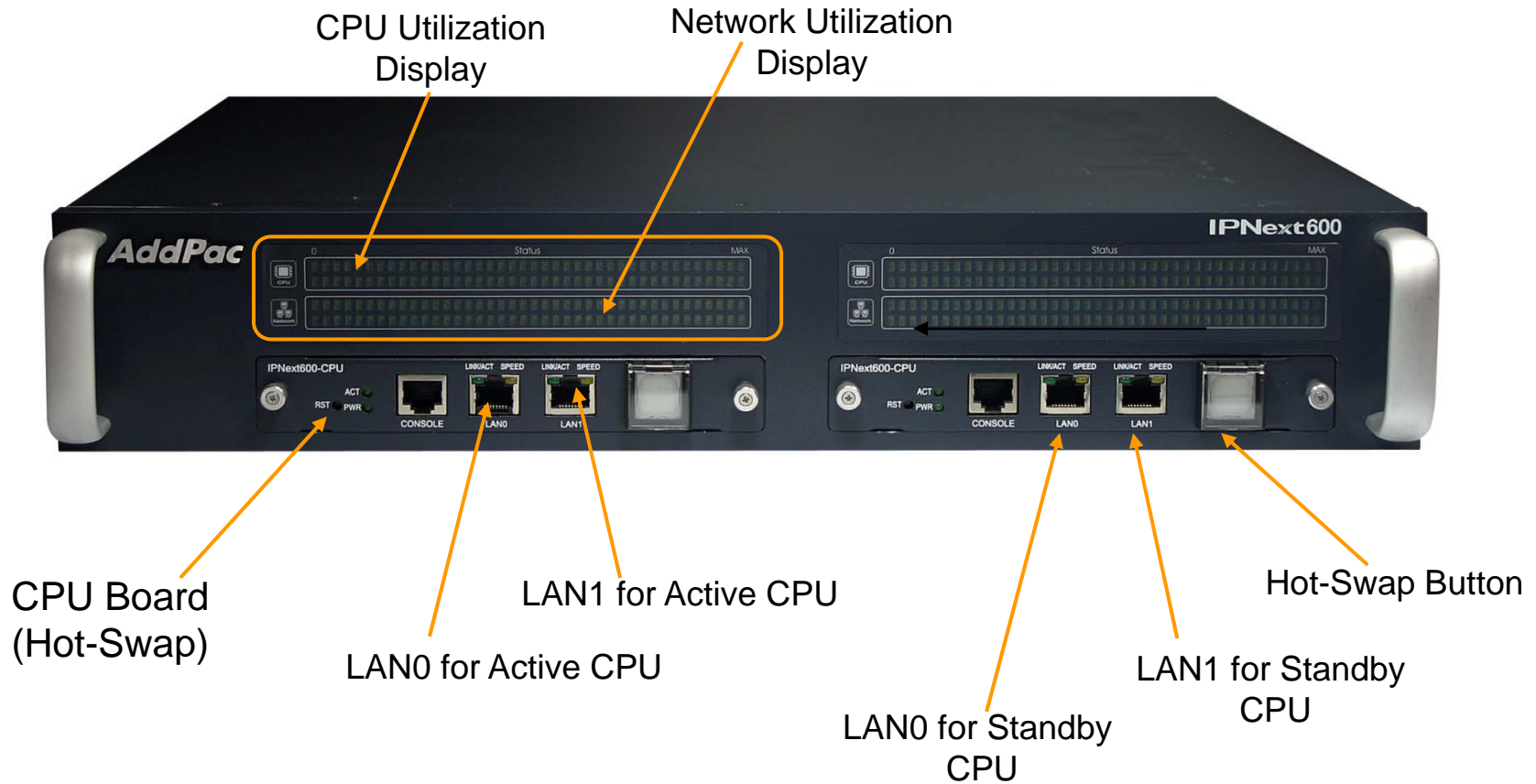

Hardware Specification

IPNext 600 Next Generation IP-PBX System



IPNext 600 Back Side



System Redundancy Features

IPNext 600 Next Generation IP-PBX System

IPNext600 System Block Diagram

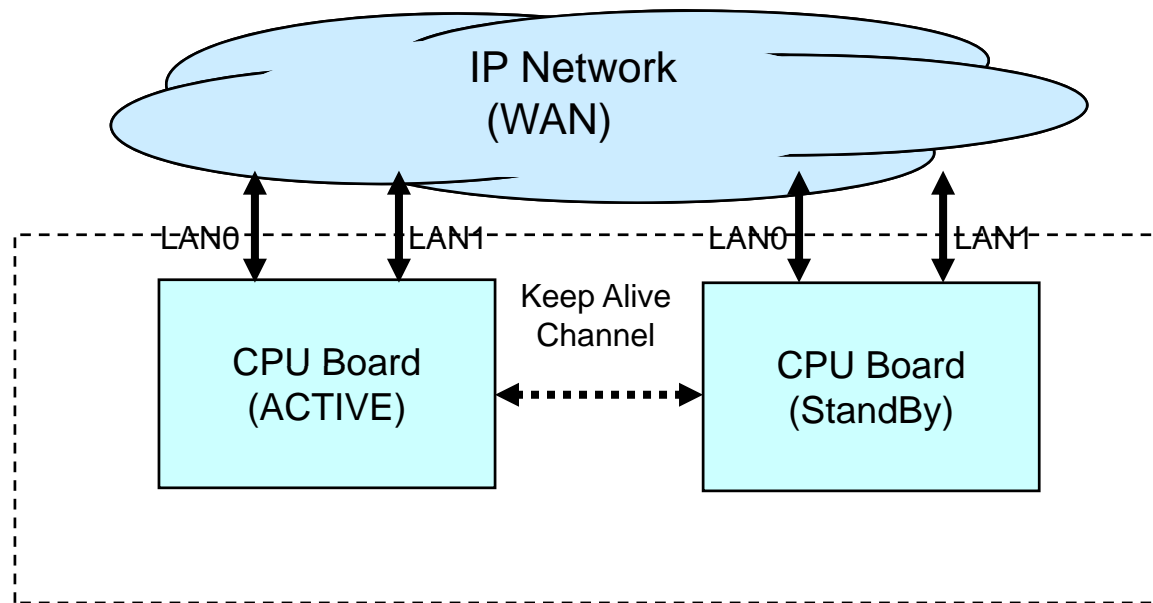

System Redundancy Features

IPNext 600 Next Generation IP-PBX System

- Active– Active Duplication Scheme
- Active – Standby Duplication Scheme
- VRRP based Duplication Scheme

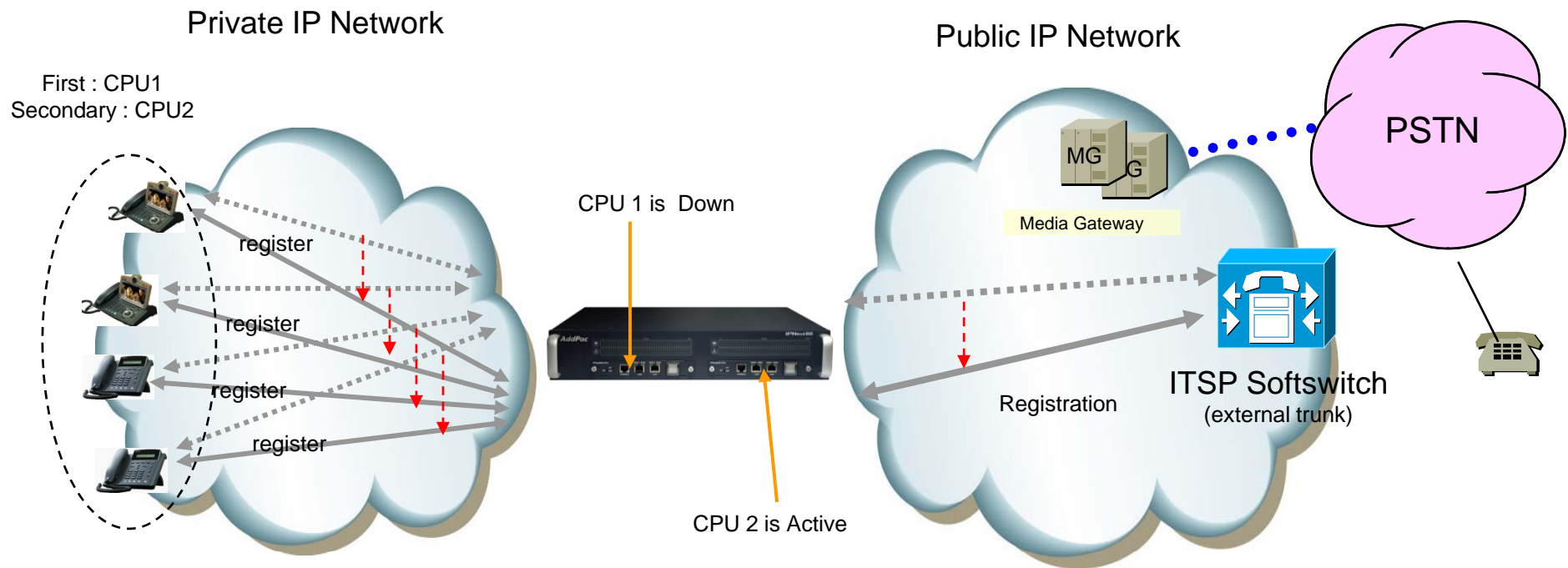

Active – Standby Duplication Scheme (example)



IP Phone Solution for Call Center

IP Phone Comparison Table

Model	AP-IP300	AP-IP230
Spec.		
LCD Size	4.3 Inch Color LCD	5 Inch Color LCD
Touch Screen	N/A	Support
Speed-Dial Keys	25 Key with Presence LED	Touch Screen based 25 Keys
Voice Codec	G.711/G.726/ G.729/G.723	G.711/G.726/ G.729/G.723
Signaling	H.323/SIP	H.323/SIP
3-Party Conversation	Support	Support
LAN Port	2	2
PoE(Optional)	Support	Support
FXO(Optional)	Support	Support

Smart Attendant Console Solution for Call Center (Option : Touch Screen)

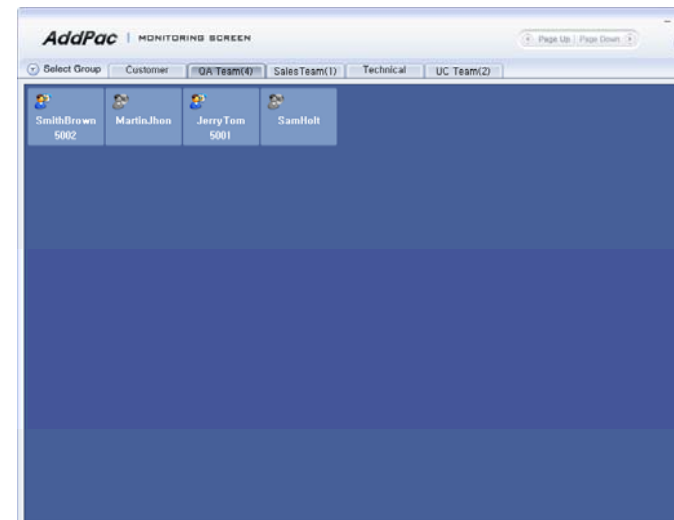
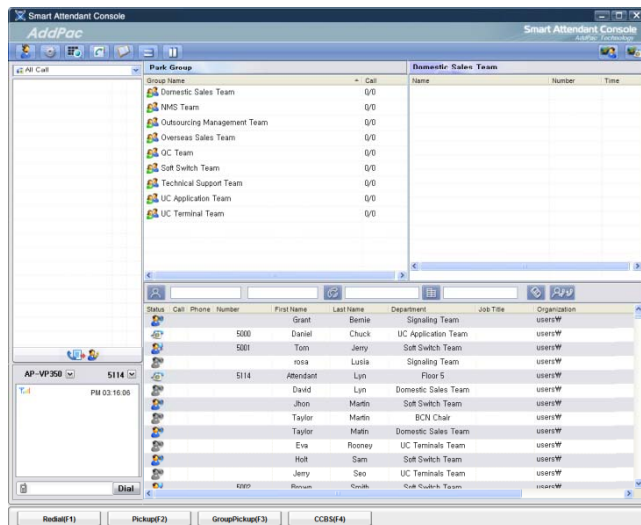

Contents

- Overview
- Smart Attendant Console Structure
- Smart Attendant Console System Diagram
- Smart Attendant Console System Configuration
- Smart Attendant Console Automatic Call Distribution
- Smart Attendant Console Feature
- Smart Attendant Console UI
 - Main Screen Feature
 - Monitoring Screen and Feature
 - Broadcasting Screen and Feature
 - Fire Alerting Screen And Feature

Overview

Support Efficiently Call Routing and Smart Presence Service

- Smart Attendant Console Function
 - Support Call Routing Service
 - Support Directory Search
 - Support User Presence Information
 - Support Phone Number Presence Information
 - Interoperation with Directory and Smart Attendant Console
 - Support Smart Call Control and Additional Service Control
 - Support Longest Wait Time based Incoming Call Process
 - Support Private Phone Book
 - Support Drag and Drop Call Control Service
 - Support Remote Broadcasting Control Feature

Smart Attendant Console Structure

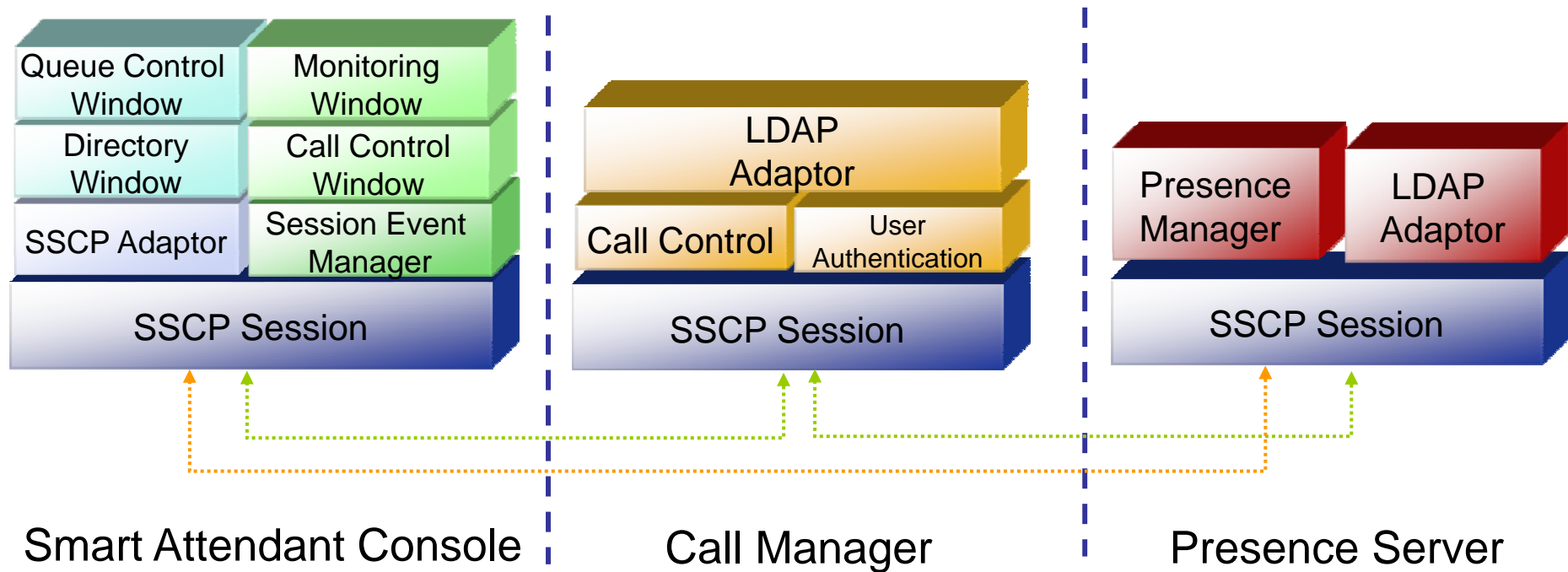

Smart Attendant Console System Diagram

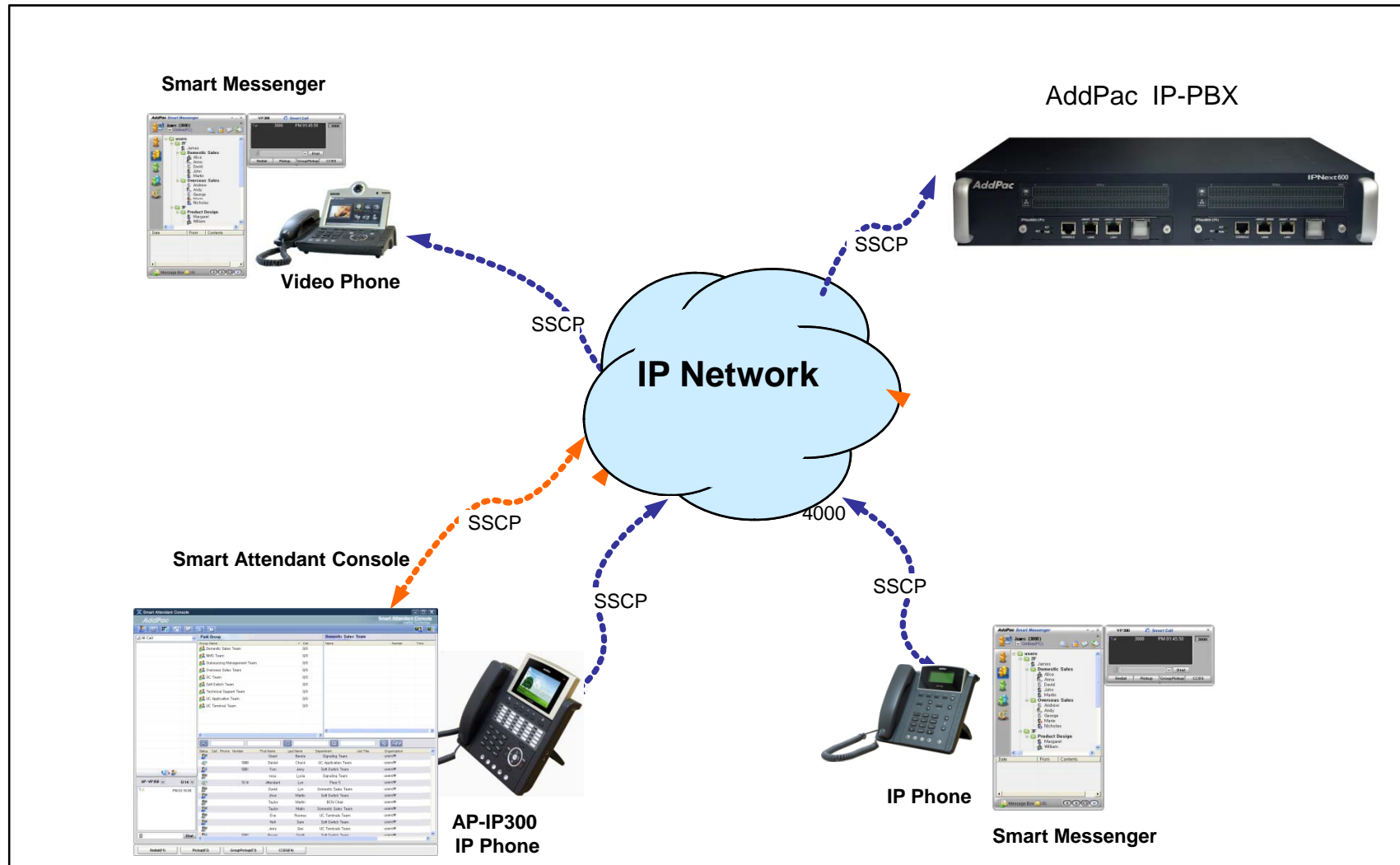

Smart Attendant Console System Configuration



Single Monitor Mode



Dual Monitor Mode

Smart Attendant Console Automatic Call Distribution

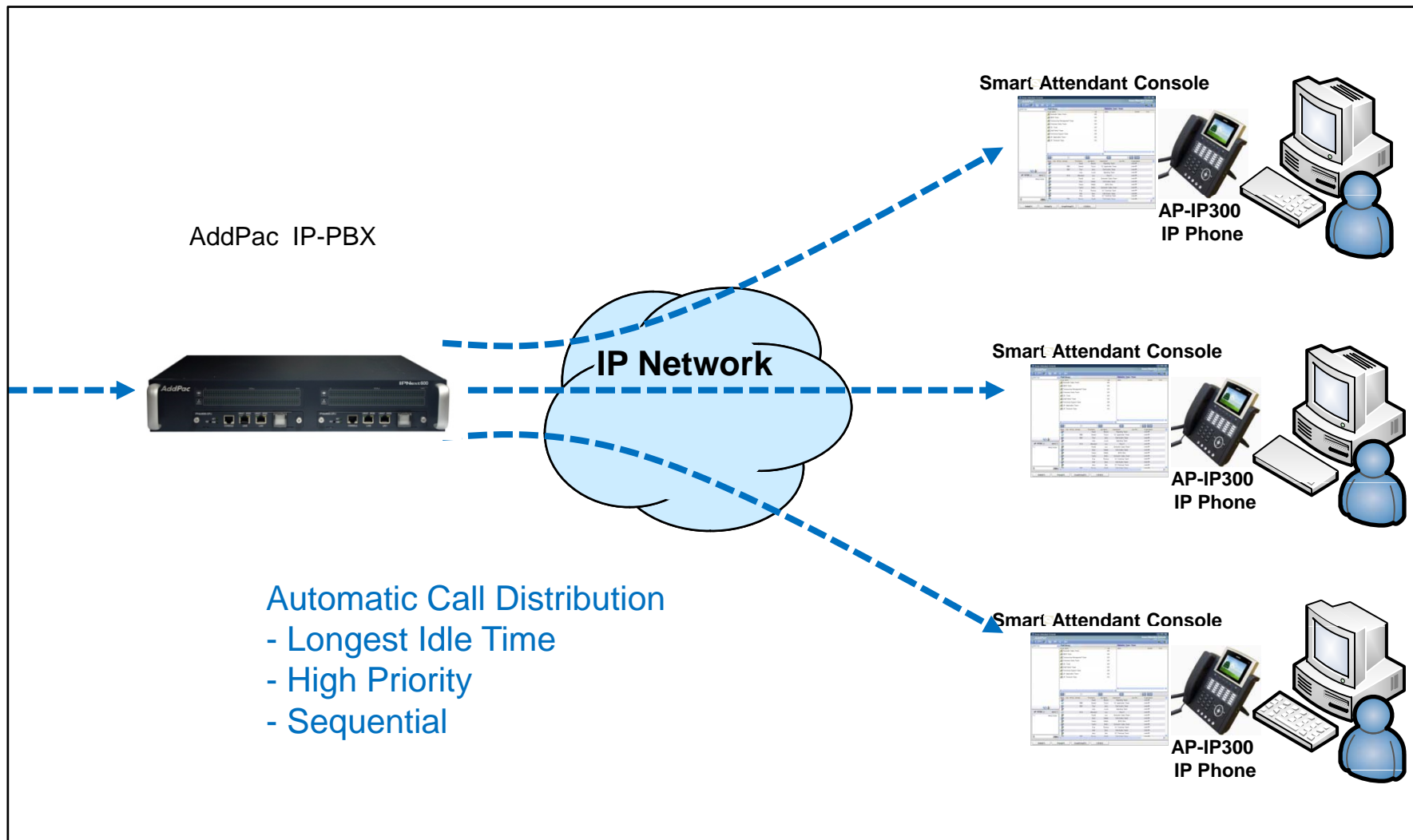

Smart Attendant Console Feature

- Smart Login Service
 - User Login and Logout Feature
- Automatic Call Distribution Feature
 - No Call Distribution Mode
 - An Available Attendant Manually Answer a Call in the Queue
 - Longest Idle Time Mode
 - Call Manager Automatically Send a Call to Longest Idle Attendant
 - Preference Mode
 - Call Manager Automatically Send a Call to High Priority Attendant
 - Sequential Mode
 - Call Manager Automatically Send a Call to an Attendant Sequentially

Smart Attendant Console Feature (cont.)

- Queue Call Control Feature
 - Wait Time Based Call Answer
 - Longest Wait Call Answer
 - Show Incoming Call by Call Type
 - Internal Call Show
 - External Call Show
 - Show All Call
 - Display Call Status Icon for Waiting Time
 - Call Busy, Call Wait Alerting, Call Wait Warning
 - User Configure the Wait Status Time

Smart Attendant Console Feature (cont.)

- Additional Call Service
 - Park Group Monitoring
 - Show Park Group Call Status for All Park Group
 - Show Detail Park Group Call List for Specify Park Group
 - Call Group Park, Park Group Call Pickup
 - Display Call Status Icon for Waiting Time
 - Call Busy, Call Wait Alerting, Call Wait Warning
 - User Configure the Wait Status Time

Smart Attendant Console Feature (cont.)

- **Additional Call Service**
 - Phone Book Feature
 - Group Create, Modify, Delete
 - Contact Add, Delete, Modify
 - Common Feature
 - Dial
 - View Detail Contact Information
 - Send e-mail
 - Dial, Send e-mail Using Phone Book
 - Private Contacts Managing Feature
 - Detail Contact Information View
 - Support Emergency / Night Mode (ToDo)
 - Configure Emergency Voice Content and Enable/Disable Emergency Mode
 - Enable/Disable Night Mode

Smart Attendant Console Feature (cont.)

- Directory Search Service
 - User Search Feature
 - Various Search Options
 - First Name, Last Name, Department, Phone Number
 - Search User Presence Status View
 - PC Online, Phone Online, PC-Phone Online
 - Working, Away, Absence
 - Be In Conference, Call Busy
 - Interoperate with Directory Search User Information
 - Double Click Call Dial and Manual Call Dial
 - Drag and Drop Call Transfer and Manual Call Transfer
 - Dynamic Conference

Smart Attendant Console Feature (cont.)

- **Monitoring Presence Service**
 - Support Monitoring Group
 - Add, Modify, Delete Monitoring Group and User
 - Add Group from Public Contacts
 - Phone Presence Status
 - Online, Working, Away, Absence
 - Be In Conference, Call Busy
 - Display Call Information
 - Caller Name, Phone Number
 - Phone Type (Phone, Mobile), Call Type (In/Out-Bound Call)
 - Display Call Status Icon for Waiting Time
 - Call Idle, Call Busy, Call Wait Alerting, Call Wait Warning
 - User Configure the Wait Status Time

Smart Attendant Console Feature (cont.)

- **Broadcasting Service**
 - Support Broadcasting Control Feature
 - Easy to Start/Stop Broadcasting
 - Show Broadcasting Group Status
 - Set Broadcasting Volume
 - Support User Friendly Design
- **Fire Alerting Service**
 - Automatic Fire Alerting Broadcasting
 - Show Fire Alerting Status

Smart Attendant Console Login

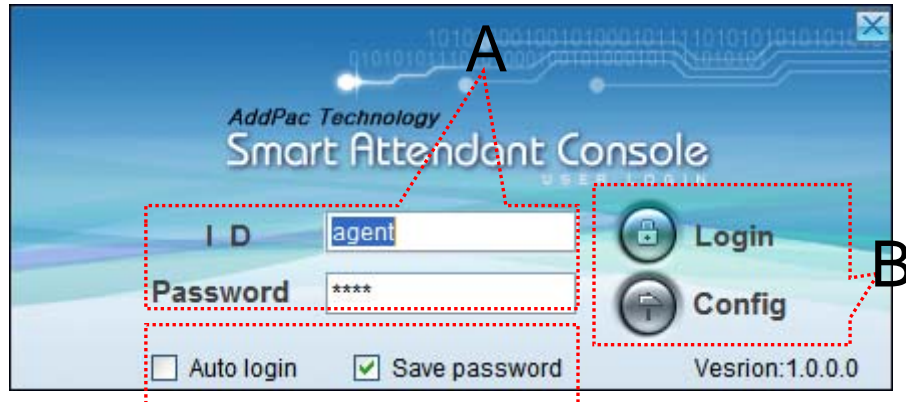

[Figure 1]

C

D

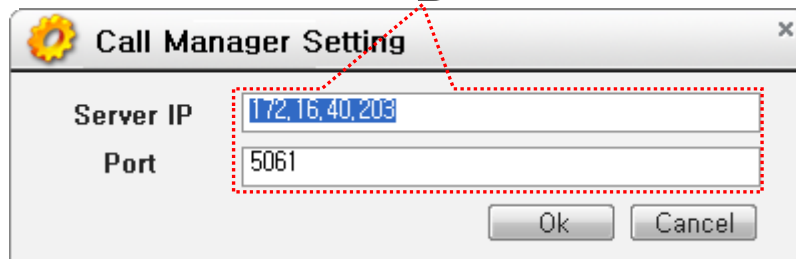

[Figure 2]



[Figure 3]

- Attendant Console Login
 - [Figure 1] shows the login picture of smart attendant Console program. “E” of [Figure3] is ICON of Smart Attendant Console Program.
 - When program is started initially, user should set the network configuration parameter such as IP address, Port number of Presence Server.[Figure2]
 - After inputting ID and Password, press the login button

Smart Attendant Console

Main Screen Feature

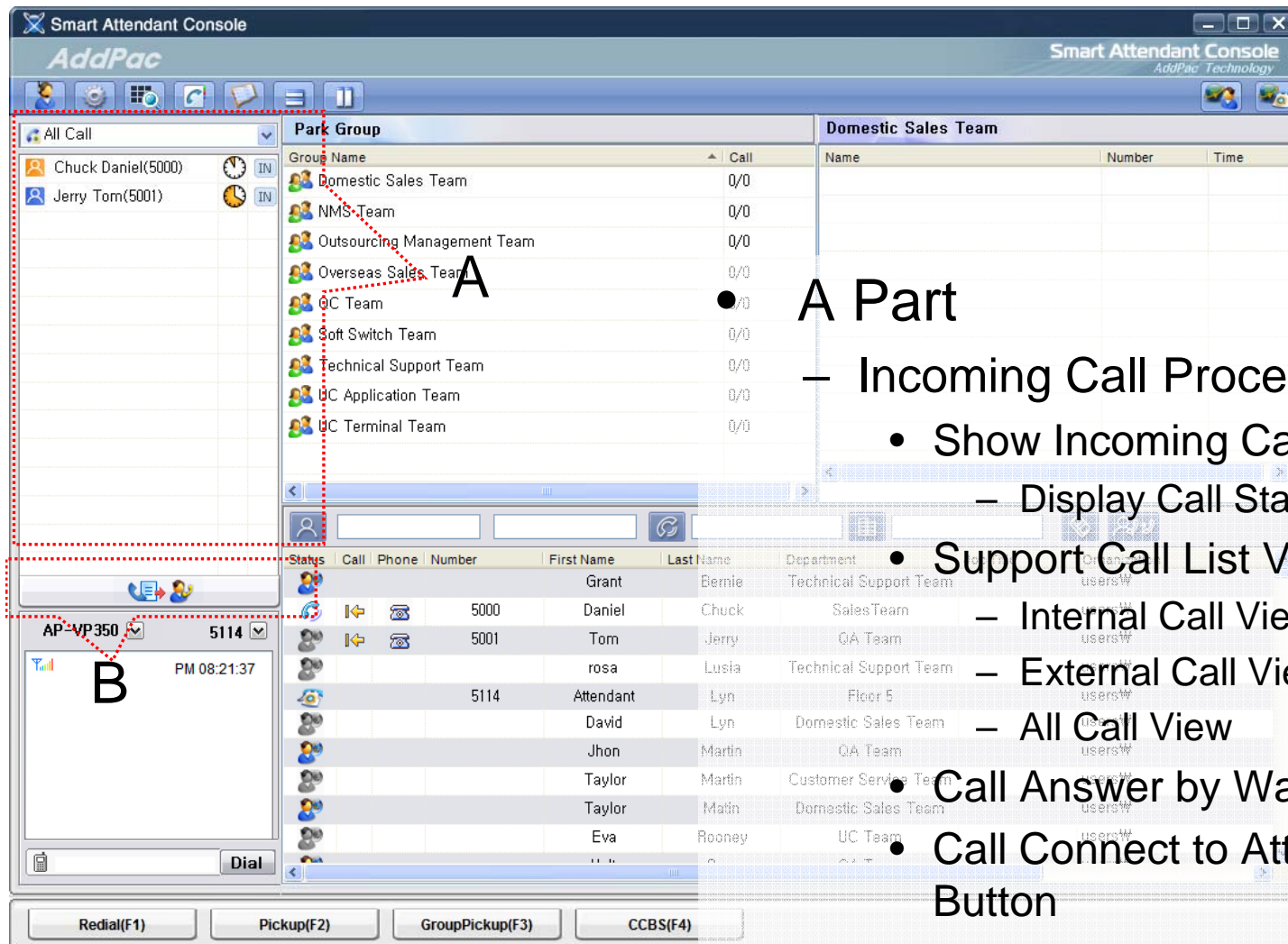

A Part

– Incoming Call Process Part

- Show Incoming Call Status
 - Display Call Status by Wait Time Icon
- Support Call List View Option

- Internal Call View
- External Call View
- All Call View

• Call Answer by Wait Time

• Call Connect to Attendant Using “B” Button

Smart Attendant Console

Main Screen Feature (cont.)

- **B Part**

- Additional Service Run Part

- Service On/Off Button
 - Configuration Button
 - Monitoring Screen Run Button
 - Phone Book Button
 - Directory Refresh Button
 - Program Arrange Layout Button

- **C Part**

- Call Control

- Connected Call Control Soft-Key
 - Support Dynamic Soft-Key
 - Input Dial Number and Dial

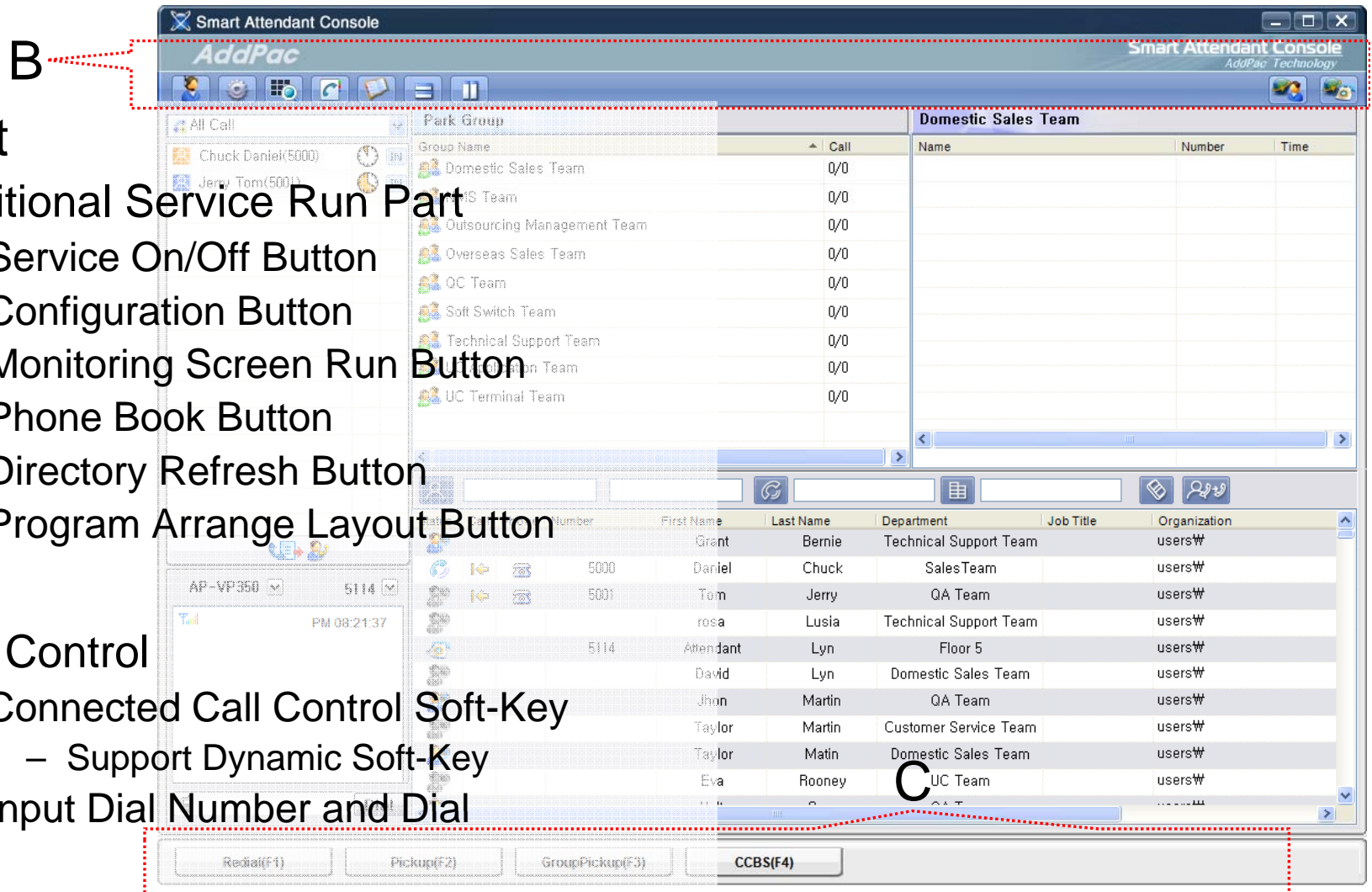

Smart Attendant Console Main Screen Feature (cont.)

- D Part
 - Directory Search Part
 - Provide Various Search Options
 - First Name, Second Name
 - Department
 - Phone Number
 - Support User Presence Service
 - Interoperation with Directory Search User

The screenshot displays the Smart Attendant Console interface. A window titled 'Smart Attendant Console' is open, showing a 'Park Group' dropdown menu with a list of groups including 'Domestic Sales Team', 'Overseas Sales Team', 'QC Team', 'Soft Switch Team', 'Technical Support Team', and 'UC Application Team'. Below this, a table shows call statistics for the 'Domestic Sales Team' with columns for 'Call' and 'Time', all showing '0/0'. A red dotted line labeled 'D' points to a search bar area. Below the search bar, a table displays user presence information with columns for 'Status', 'Call', 'Phone', 'Number', 'First Name', 'Last Name', 'Department', 'Job Title', and 'Organization'. The table lists several users, including Daniel Chuck, Tom Jerry, rosa Lusia, David Lyn, Jhon Martin, Taylor Martin, Taylor Matin, and Eva Rooney. A green dotted circle highlights the 'CCBS(F4)' button in the bottom toolbar.

Call	Time
0/0	
0/0	
0/0	
0/0	
0/0	
0/0	
0/0	
0/0	
0/0	

Status	Call	Phone	Number	First Name	Last Name	Department	Job Title	Organization
				Grant	Bernie	Technical Support Team		usersW
			5000	Daniel	Chuck	Sales Team		usersW
			5001	Tom	Jerry	QA Team		usersW
				rosa	Lusia	Technical Support Team		usersW
			5114	Attendant	Lyn	Floor 5		usersW
				David	Lyn	Domestic Sales Team		usersW
				Jhon	Martin	QA Team		usersW
				Taylor	Martin	Customer Service Team		usersW
				Taylor	Matin	Domestic Sales Team		usersW
				Eva	Rooney	UC Team		usersW

Smart Attendant Console Main Screen Feature (cont.)

The screenshot displays the Smart Attendant Console interface. The top section shows a 'Park Group' list with columns for 'Group Name' and 'Call'. The 'Technical Support Team' is selected, showing a call count of 1/2. A red dashed box labeled 'E' highlights this section. Below the list, a 'Technical Support Team' detail panel shows a list of team members with columns for 'Name', 'Number', and 'Time'. The bottom section shows a call list with columns for 'Status', 'Call', 'Phone', 'Number', 'First Name', 'Last Name', 'Department', 'Job Title', and 'Organization'. The bottom of the interface features function buttons: 'Redial(F1)', 'Pickup(F2)', 'GroupPickup(F3)', and 'CCBS(F4)'.

Group Name	Call
Domestic Sales Team	0/0
NMS Team	0/0
Outsourcing Management Team	0/0
Overseas Sales Team	0/0
QC Team	0/0
Soft Switch Team	0/0
Technical Support Team	1/2
UC Application Team	0/0
UC Terminal Team	0/0

Name	Number	Time
DanielChuck	5000	62
TomJerry	5001	38

Status	Call	Phone	Number	First Name	Last Name	Department	Job Title	Organization
			5000	Daniel	Chuck	UC Application Team		
			5001	Tom	Jerry	Soft Switch Team		
				rosa	Lusia	Signaling Team		
			5114	Attendant	Lyn	Floor 5		
				David	Lyn	Domestic Sales Team		
				Jhon	Martin	Soft Switch Team		
				Taylor	Martin	BCN Chair		
				Taylor	Martin	Domestic Sales Team		
				Rooney		UC Terminals Team		

- E Part
 - Park Group Management Part
 - Show Park Group Call Status
 - Show Detail Park Group Call List
 - Support Group Park, Group Park Call Pickup

Smart Attendant Console Main Screen Feature (cont.)

- F Part
 - Phone Book Management Part
 - Group Create, Modify, Delete
 - Contact Add, Delete, Modify
 - Common Feature
 - Dial
 - View Detail Contact Information
 - Send e-mail
 - Dial, Send e-mail Using Phone Book
 - Private Contacts Managing Feature
 - Detail Contact Information View

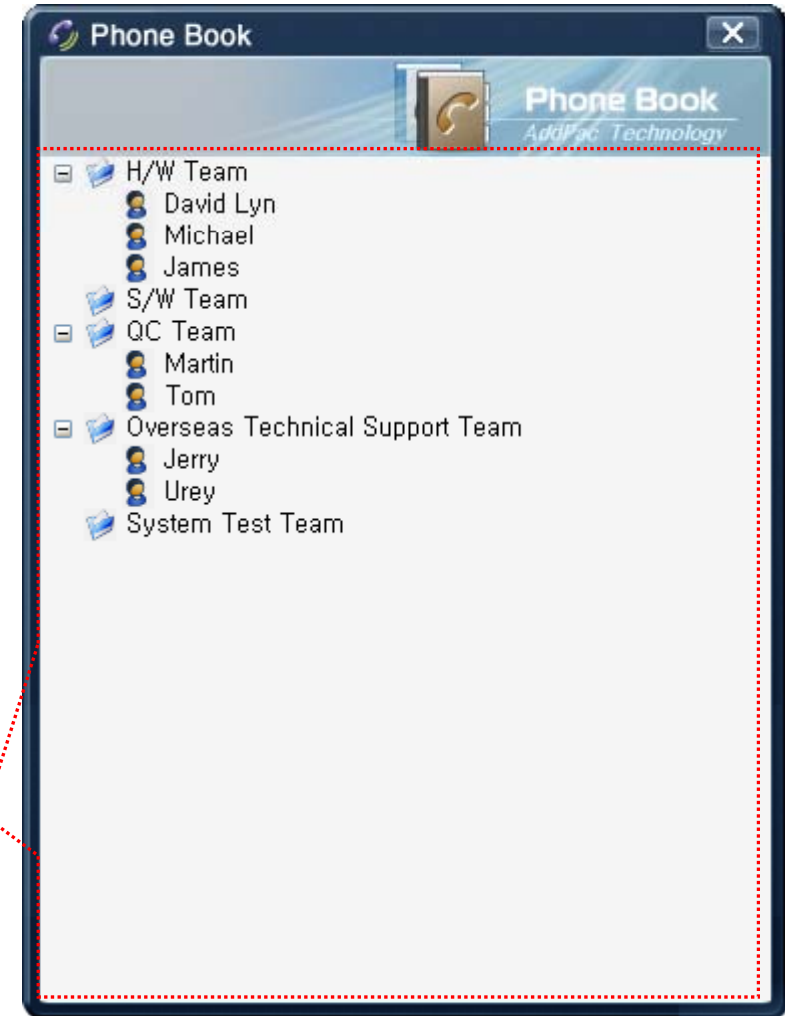

Smart Attendant Console Monitoring Screen Feature

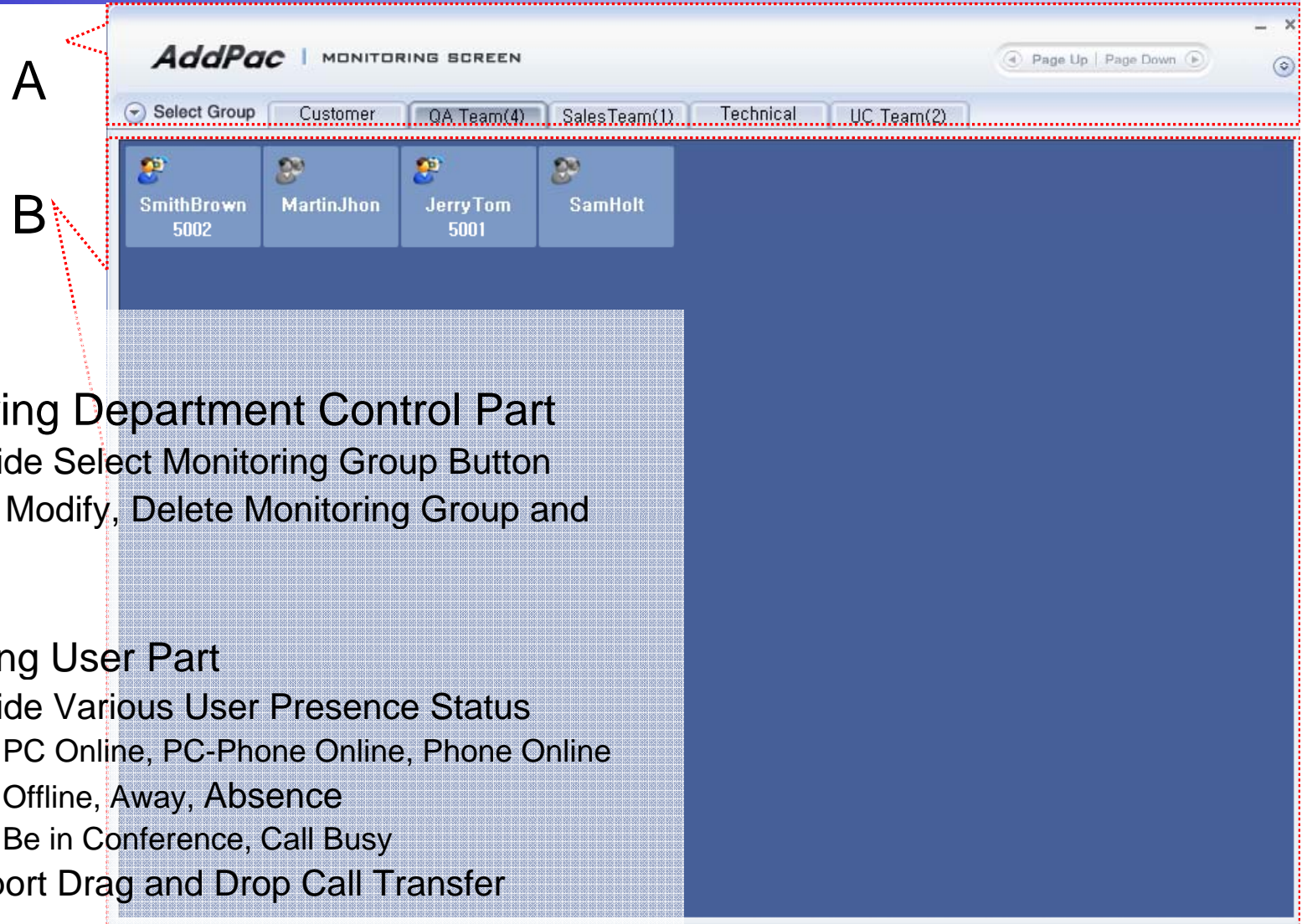

- A Part
 - Monitoring Department Control Part
 - Provide Select Monitoring Group Button
 - Add, Modify, Delete Monitoring Group and User
- B Part
 - Monitoring User Part
 - Provide Various User Presence Status
 - PC Online, PC-Phone Online, Phone Online
 - Offline, Away, Absence
 - Be in Conference, Call Busy
 - Support Drag and Drop Call Transfer

Smart Attendant Console Broadcasting Screen Feature

- A Part
 - Broadcasting Status Part
 - Show Group Broadcasting Status
 - Broadcasting, Idle, Other Service
- B Part
 - Broadcasting Control Part
 - Broadcasting Start/Stop Button
 - Chime Bell Play Button
 - Volume Control Button

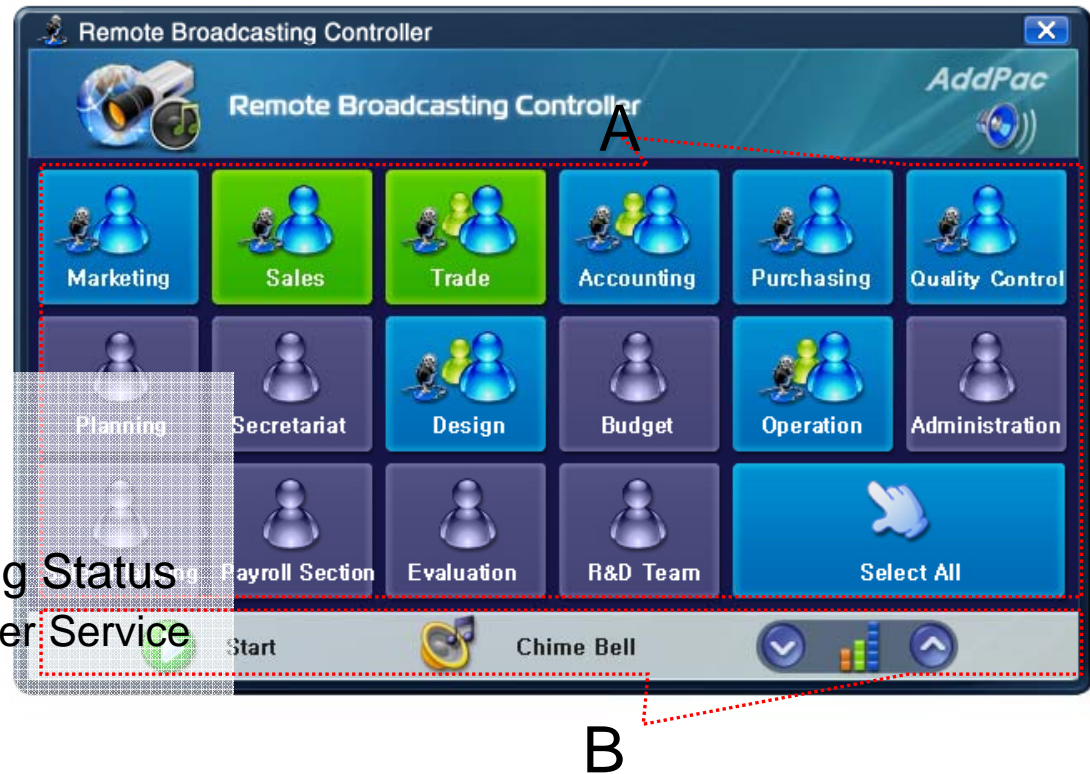

Smart Attendant Console

Fire Alerting Screen Feature

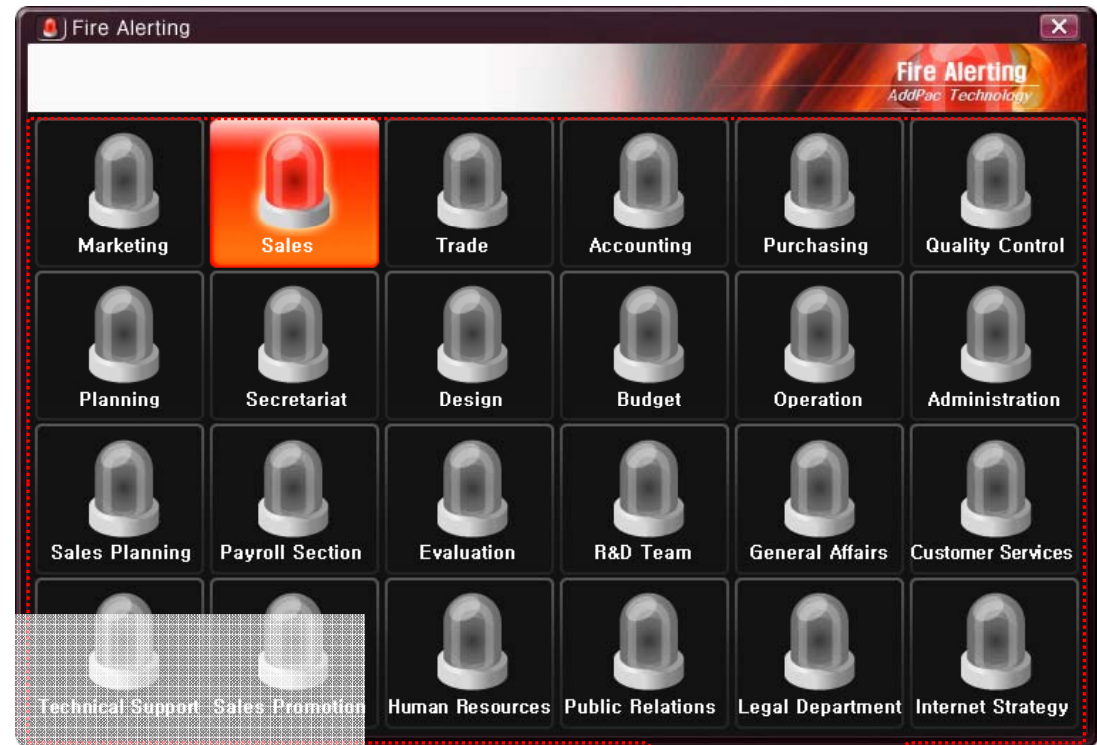

- A Part
 - Fire Alerting Part
 - Automatic Fire Alerting Broadcasting
 - Show Fire Alerting Status



IP Voice Recording Solution

Contents

- IP Voice Recording Servers
- Network Diagram for Voice Recording
- SIP Voice Call Flow Diagram
- Smart Digital Voice Recording Management Program



IP Voice Recording Server AP-NR5000

Product Overview

AP-NR5000 IP Voice Recording Server

- IP based Voice Recording Server
- Linux Operating System
- Powerful Management and User Friendly Features
- High-performance Voice/Video Recording Service
- External IP Phone (AP-IP300, AP-IP230, etc) Interworking Support
- Firmware Upgradeable Architecture
- One(1) 10/100/1000Mbps Gigabit Ethernet Interface
- Up to Five(5) 3.5Inch SATA Hard Disk Interface Support
- USB Interface Support

Hardware Specification

AP-N5000 IP Voice Recording Server

- High Performance Computing Power
- Main Processor Board
 - Network Interface
 - One(1) 10/100/1000Mbps Gigabit Ethernet
 - Video Output Interface
 - RGB Video Output
 - USB 2.0 Interfaces for Mouse, Keyboard, etc
- Hard Disk Board
 - Module Type Design
 - Up Five(5) Hard Disk Slots
 - 10~20 Tera HDD Capacity
- Power Supply
 - Dual Power Supply for Power Redundancy
 - Module Type Power Supply

Hardware Specification

AP-NR5000 IP Voice Recording Server

AP-NR5000 Front Side

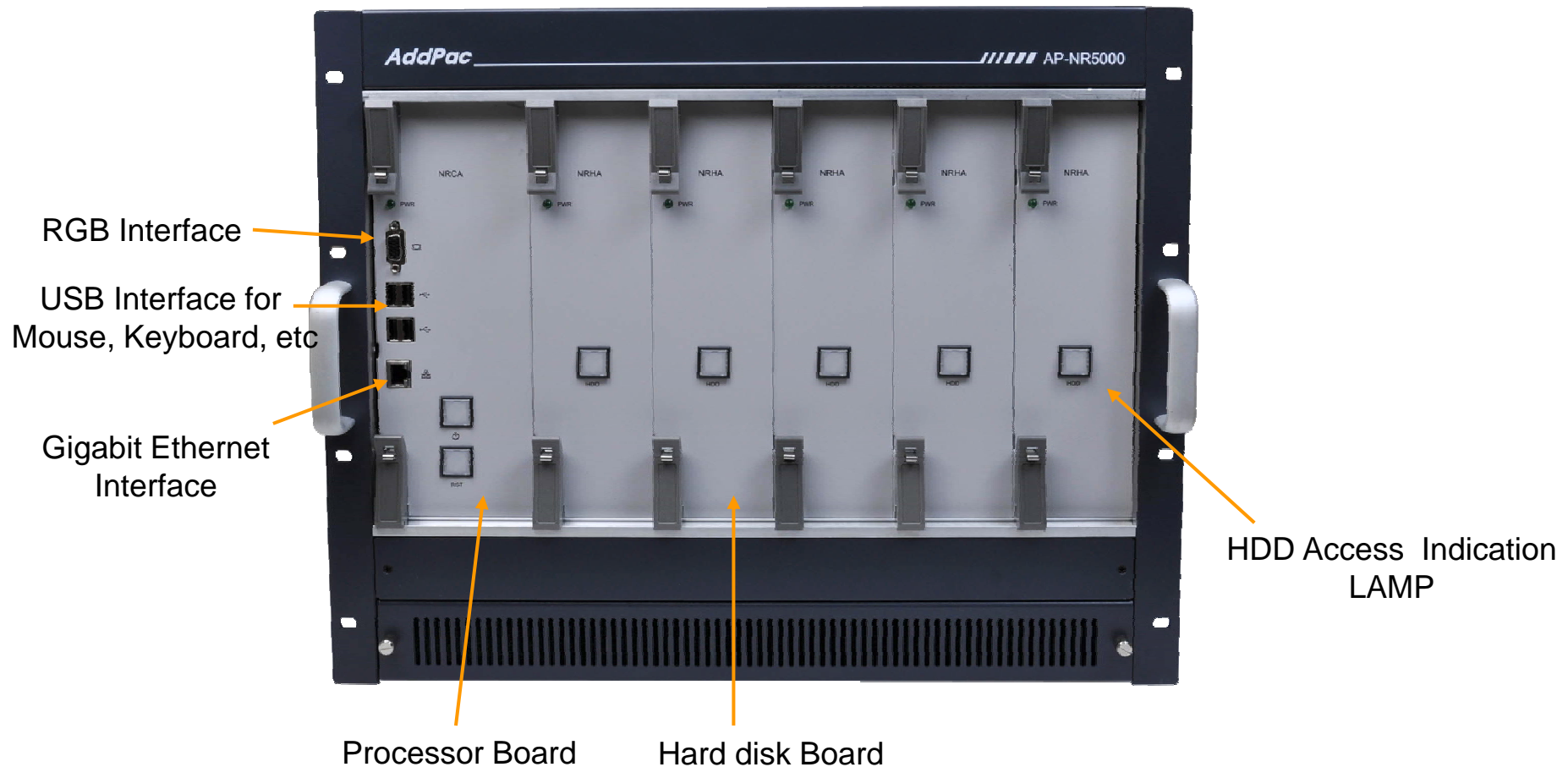

Hardware Specification

AP-NR5000 IP Voice Recording Server

AP-NR5000 Back Side

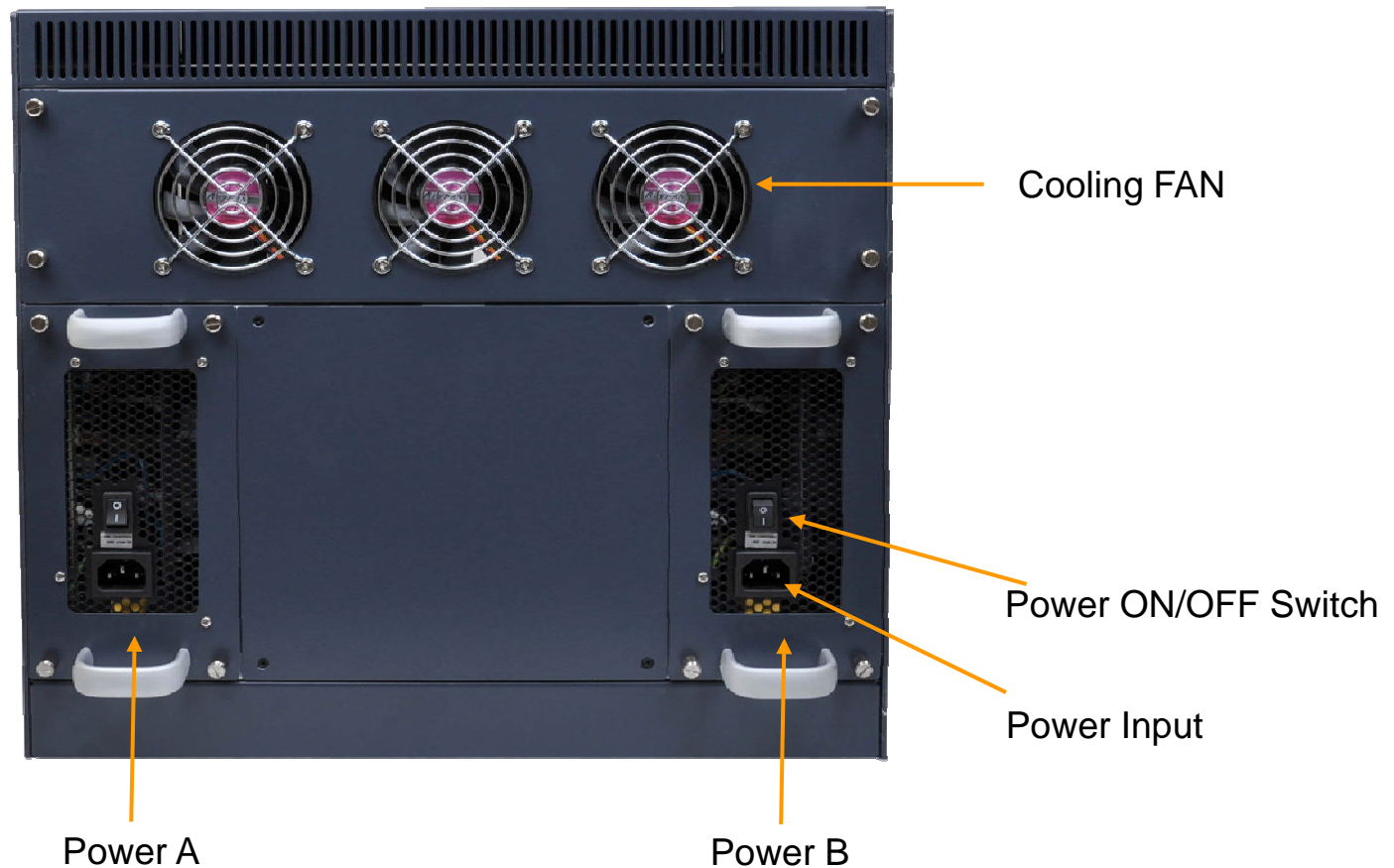



IP Voice Recording Server AP-NR3000

Product Overview

AP-NR3000 IP Voice Recording Server

- IP based Voice Recording Server
- Linux Operating System
- Powerful Management and User Friendly Features
- High-performance Voice/Video Recoding Service
- External IP Phone (AP-IP300, AP-IP230, etc) Interworking Support
- Firmware Upgradeable Architecture
- One(1) 10/100/1000Mbps Gigabit Ethernet Interface
- One(1) DVD Writer for Audio File Backup
- Up to Four(4) 3.5Inch SATA Hard Disk Interface Support
- USB Interface Support (Front Side, Back Side)

Hardware Specification

AP-N3000 IP Voice Recording Server

- High Performance Computing Power
- Main Chassis
 - Network Interface
 - One(1) 10/100/1000Mbps Fast Ethernet
 - Video Output Interface
 - HDMI, DVI, RGB Video Output
 - USB 2.0 Interfaces for Mouse, Keyboard, etc
 - One(1) DVD Writer for Video File Backup
 - Up to Four(4) Hard Disk

Hardware Specification

AP-NR3000 IP Voice Recording Server

AP-NR3000 Front Side

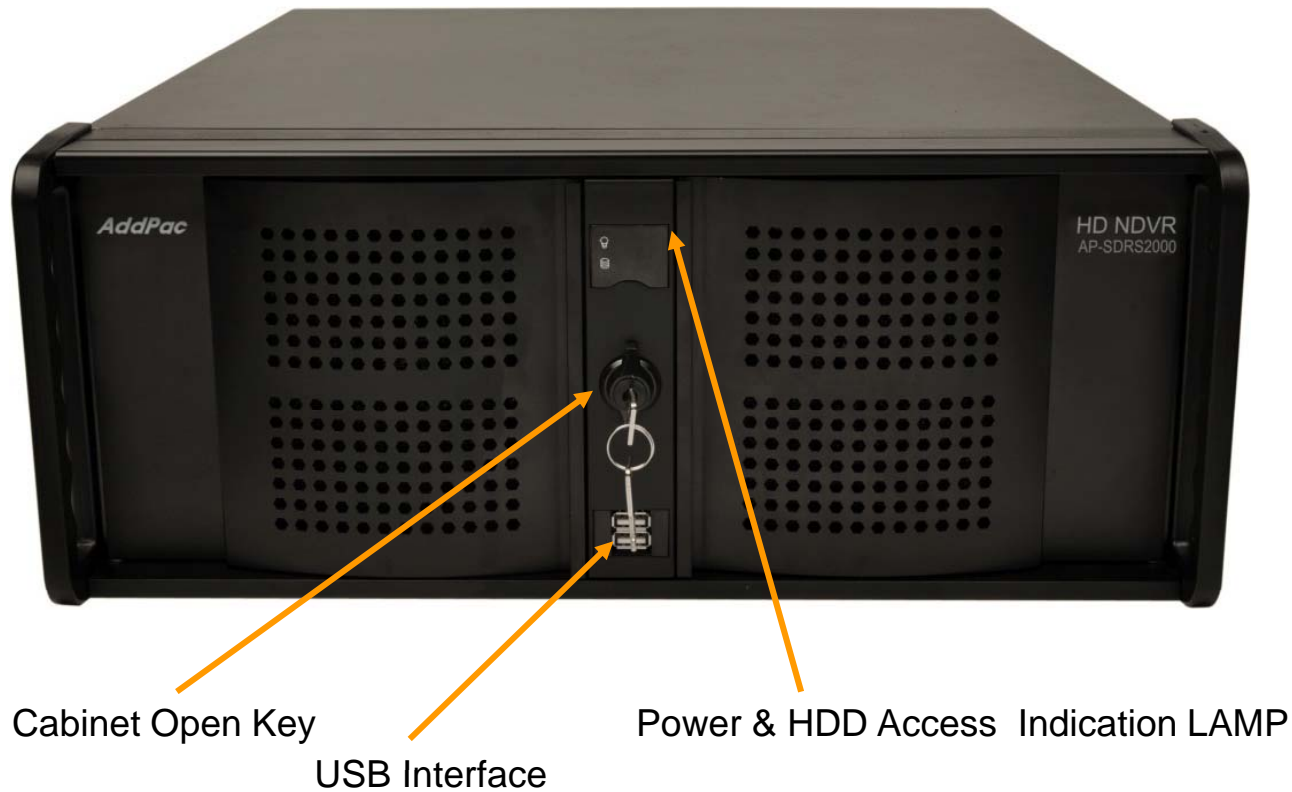

Hardware Specification

AP-NR3000 IP Voice Recording Server

AP-NR3000 Back Side

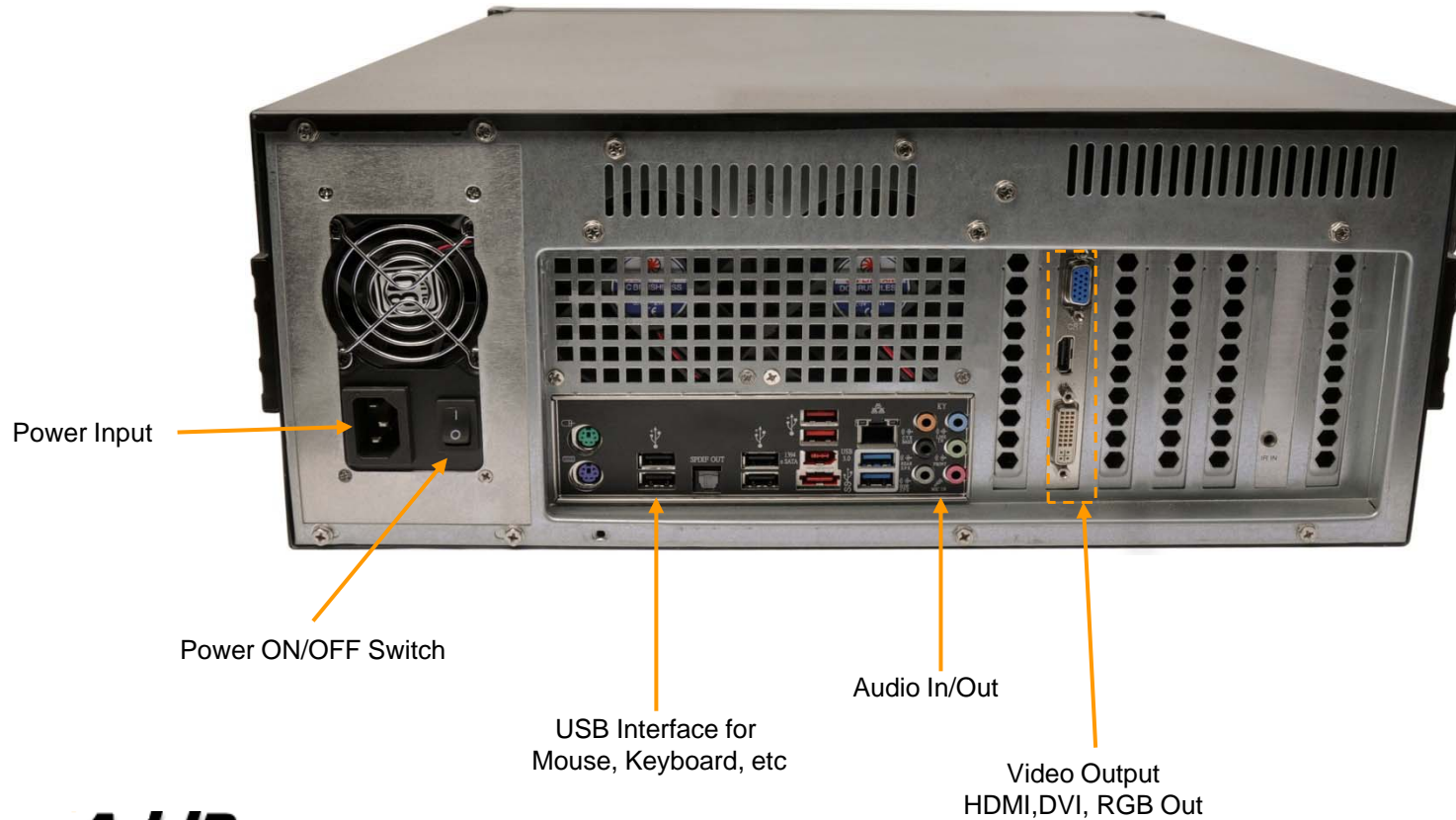

Network Diagram for IP Phone Recording

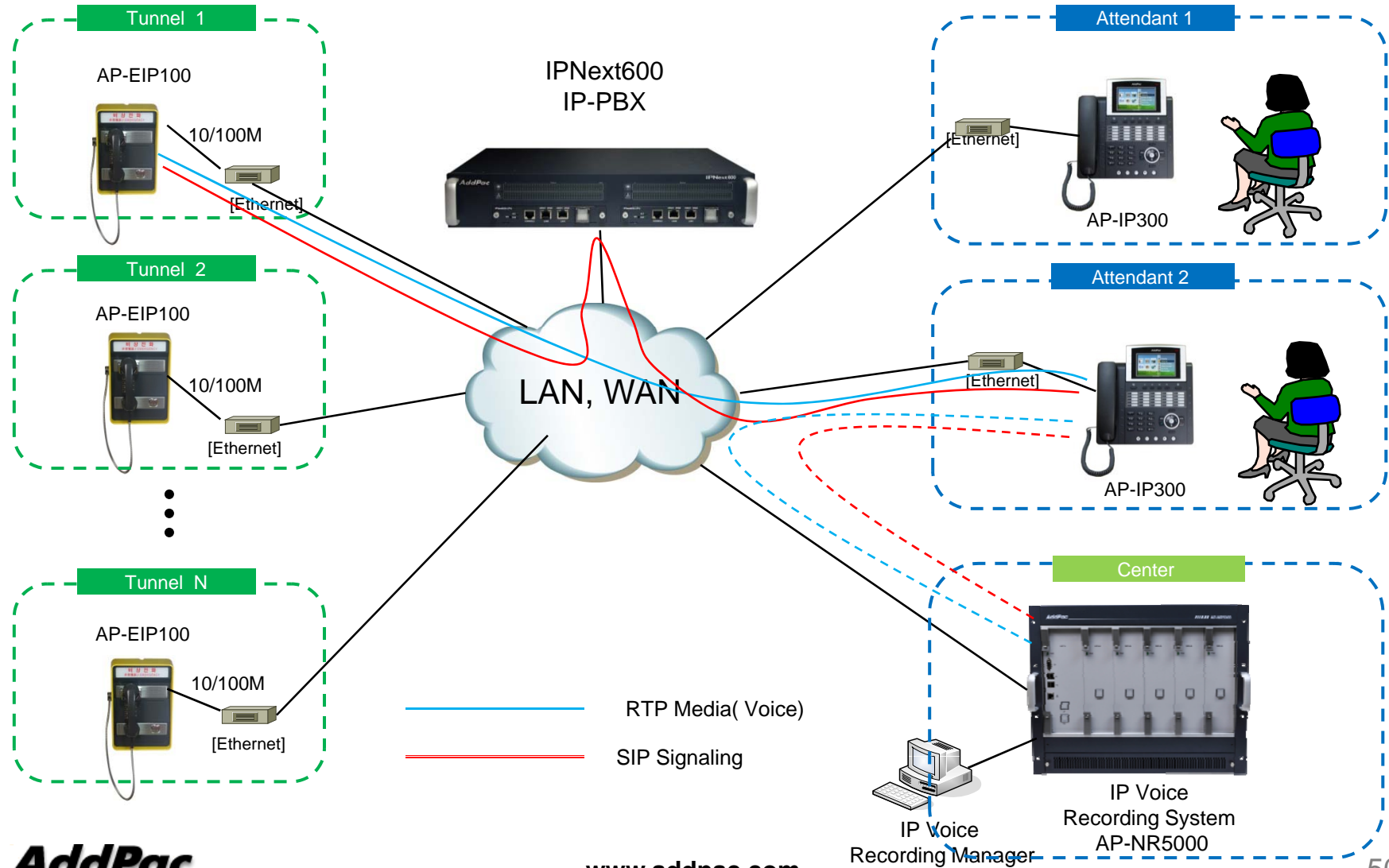

SIP VoIP Call Flow

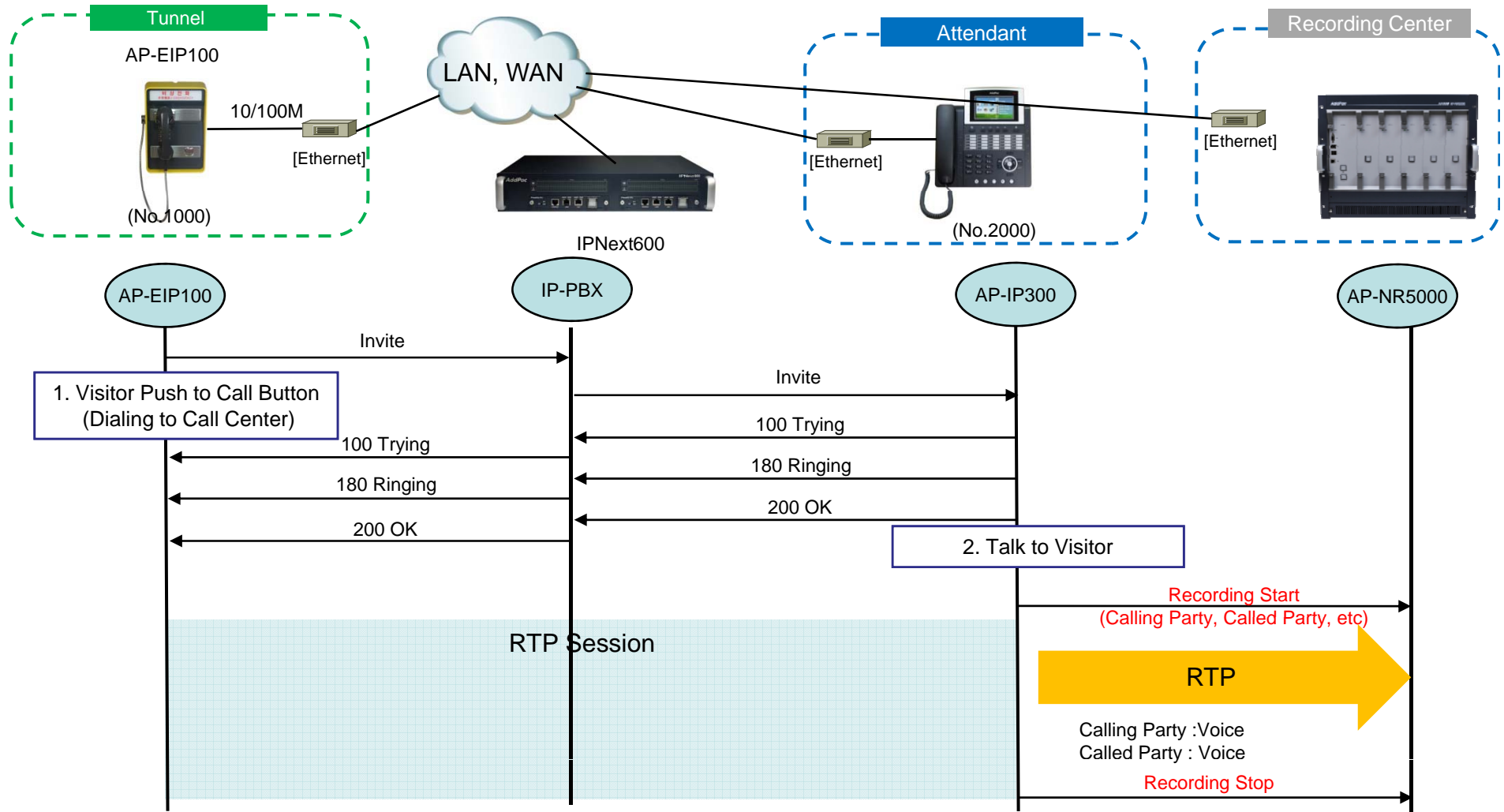



Smart DVoiceR Manager

Smart DV_{ideo} door phoneR Management Program

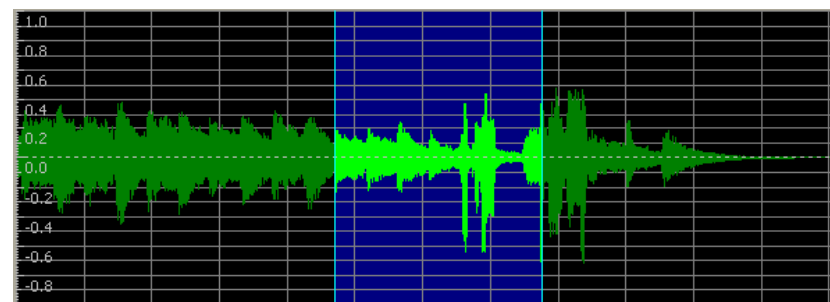
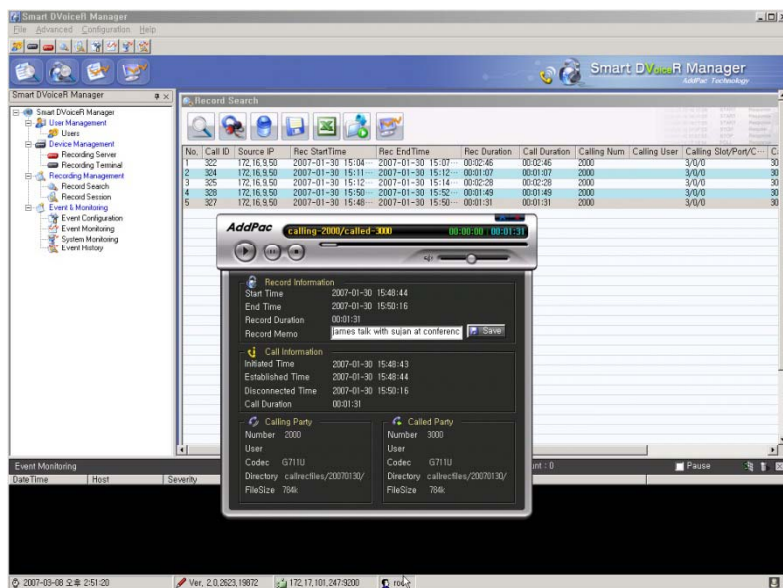

- Call History Management (search/modify/delete/save)
- Media Play Management (Play/Stop/Seek/Pause)
- Live Call List Management, Live Call Monitoring
- Local Backup (File Manager Support, PC HDD, DVD) and Local Play
- User Management (registration/modify/delete/search)
- Server Status (CPU/Memory/HDD) & Event Monitoring
- Recording Source Management (Video Phone, etc)
- Live Recording Board

UI example (recording file search..)

Recording File Search Result

Calling Num ▼ 9000 Search

	Calling Number	Called Number	Recording Start Time	Recording End Time	Duration (sec)	Play
<input type="checkbox"/>	9000	5000	2010/03/17 09:50:45	2010/03/17 09:51:45	60	Play
<input checked="" type="checkbox"/>	9000	3000	2010/03/18 09:00:12	2010/03/17 09:00:45	33	Play
<input checked="" type="checkbox"/>	9002	9000	2010/03/18 10:50:12	2010/03/17 10:55:12	300	Play
<input type="checkbox"/>	9005	9000	2010/03/18 15:12:03	2010/03/18 15:12:13	10	Play
<input type="checkbox"/>	9006	9000	2010/03/19 01:10:23	2010/03/19 01:11:10	47	Play

[1] [2] [3] ... [Next] Backup

Powerful Recording Search
* calling number
* called number
* date
* call identifier, etc

Recording Play

Recording Backup
* selected files from recording server to PC storage

Calling Number : Video Door Phone
Called Number : Video Phone (attendant)

Login

The image shows the 'Smart DVoiceR Manager' login screen. At the top, it says 'AddPac Technology' and 'Smart DVoiceR Manager USER LOGIN'. There are two input fields: 'I D' with 'root' and 'Password' with '*****'. To the right are 'Login' and 'Setting' buttons. Below the fields are checkboxes for 'Auto login' (unchecked) and 'Save password' (checked). A 'Setting' dialog box is open, titled 'Setting', with a 'Smart Recording Server' section containing 'IP Address' (172.16.4.22) and 'Port' (9200, default: 9200). 'OK' and 'Cancel' buttons are at the bottom of the dialog. Red arrows point from the 'Auto login' checkbox to the text 'Auto Login Configuration' and from the 'Save password' checkbox to 'Password Save'. Another red arrow points from the 'Setting' button to the 'Setting' dialog box.

Auto Login Configuration

Password Save

Setting

Smart Recording Server

IP Address 172.16.4.22

Port 9200 (default: 9200)

OK Cancel

User Management

The screenshot shows the Smart DVoiceR Manager application window. The main window title is "Smart DVoiceR Manager" and it has a menu bar with "File", "Advanced", "Configuration", and "Help". Below the menu bar is a toolbar with various icons. The main content area is titled "Smart DVoiceR Manager" and "AddPac Technology". On the left, there is a tree view showing the application structure, with "User Management" expanded to show "Users".

Three red arrows point to specific icons in the "Users" window:

- New Manager Registration**: Points to the "Add" icon (a person with a plus sign).
- Manager Information Modification**: Points to the "Edit" icon (a person with a pencil).
- Manager Delete**: Points to the "Delete" icon (a person with a minus sign).

The "Users" window displays a table with the following data:

No.	ID	Name	Description
1	Administrator	Administrator	Addpac Administrator
2	root	recording manager	Maintenance dept.

The status bar at the bottom shows the date and time "2007-06-13 오후 1:43:49", the version "Ver. 1.0.2719", the IP address "172.16.31.14:9200", and the user "root".

Recording Server Status Monitoring

Smart DVoiceR Manager

File Advanced Configuration Help

Smart DVoiceR Manager

- Smart DVoiceR Manager
 - User Management
 - Users
 - Device Management
 - Smart Recording Server
 - Smart Recording Terminal
 - Recording Management
 - Record Search
 - Record Session
 - Event & Monitoring
 - Event Configuration
 - Event Monitoring
 - System Monitoring
 - Event History
 - Recording Board
 - Board Users
 - Board Groups
 - Map List

Smart Recording Server Status

172.16.31
Smart Re

Configuration Client Session List

Max Session : 10

Keep Alive Interval : 15 sec

OK

Smart Recording Server Status

172.16.31.14:9200
Smart Recording Server is running.

Configuration Client Session List

No.	User	IP Address	Port	Access Time	Duration
1	root	172.16.1.31	4417	2007-06-13 13:40:05	00:04:49

Client List

OK Cancel

2007-06-13 오후 1:46:20 Ver. 1.0.2719 172.16.31.14:9200 root

Recording File Management

(Recorded File Monitoring (play/seek/pause/resume/stop))

The screenshot displays the Smart DVoiceR Manager software interface. The main window shows a 'Record Search' table with columns for No., Call ID, Source IP, Rec StartTime, Rec EndTime, Rec Duration, Call Duration, Calling Num, Calli..., Calling..., Called Num, Calle..., and Called S... The table contains 19 rows of recording data. A 'Search Filter' dialog box is open, showing search criteria for 'Calling Number' (2000) and 'Called Number' (3000). A recording playback window is overlaid on the table, showing 'AddPac calling-3004/called-5020' with a progress bar and a 'Memo Save' button. The playback window also displays 'Record Information' and 'Call Information' details.

No.	Call ID	Source IP	Rec StartTime	Rec EndTime	Rec Duration	Call Duration	Calling Num	Calli...	Calling...	Called Num	Calle...	Called S...
1	39500	172.17.213.100	2007-06-13 13:12:15	2007-06-13 13:12:43	00:00:28	00:00:28	3000		4/0/0	5016		4/0/0
2	39502	172.17.213.100	2007-06-13 13:12:15	2007-06-13 13:12:43	00:00:28	00:00:28	3001		4/1/0	5017		4/1/0
3	39504	172.17.213.100	2007-06-13 13:12:15	2007-06-13 13:12:43	00:00:28	00:00:28	3002		4/2/0	5018		4/2/0
4	39506	172.17.213.100	2007-06-13 13:12:15	2007-06-13 13:12:43	00:00:28	00:00:28	3003		4/3/0	5019		4/3/0
5	39508	172.17.213.100	2007-06-13 13:12:15	2007-06-13 13:12:44	00:00:28	00:00:28	3004		5/0/0	5020		5/0/0
6	39510	172.17.213.100	2007-06-13 13:12:15	2007-06-13 13:12:44	00:00:28	00:00:28	3005		5/1/0	5021		5/1/0
7	39512	172.17.213.100	2007-06-13 13:12:15	2007-06-13 13:12:45	00:00:29	00:00:28	3006		5/2/0	5022		5/2/0
8	39514	172.17.213.100	2007-06-13 13:12:15	2007-06-13 13:12:45	00:00:29	00:00:28	3007		5/3/0	5023		5/3/0
9	39516	172.17.213.100	2007-06-13 13:12:15	2007-06-13 13:12:45	00:00:29	00:00:28	3007		5/3/0	5023		5/3/0
10	39518	172.17.213.100	2007-06-13 13:12:15	2007-06-13 13:12:45	00:00:29	00:00:28	3007		5/3/0	5023		5/3/0
11	39520	172.17.213.100	2007-06-13 13:12:16	2007-06-13 13:12:16	00:00:00	00:00:00				5024		6/0/0
12	39522	172.17.213.100	2007-06-13 13:12:16	2007-06-13 13:12:16	00:00:00	00:00:00				5025		6/1/0
13	39524	172.17.213.100	2007-06-13 13:12:16	2007-06-13 13:12:16	00:00:00	00:00:00				5026		6/2/0
14	39526	172.17.213.100	2007-06-13 13:12:17	2007-06-13 13:12:17	00:00:00	00:00:00				5027		6/3/0
15	39528	172.17.213.100	2007-06-13 13:12:17	2007-06-13 13:12:17	00:00:00	00:00:00				5028		7/0/0
16	39529	172.17.213.100	2007-06-13 13:12:17	2007-06-13 13:12:17	00:00:00	00:00:00				5029		7/1/0
17	39498	172.17.213.100	2007-06-13 13:12:17	2007-06-13 13:12:17	00:00:00	00:00:00				5030		7/2/0
18	39499	172.17.213.100	2007-06-13 13:12:17	2007-06-13 13:12:17	00:00:00	00:00:00				5031		7/3/0
19	39501	172.17.213.100	2007-06-13 13:12:17	2007-06-13 13:12:17	00:00:00	00:00:00				2000		0/0/0
										2001		0/1/0
										2002		0/2/0
										2003		0/3/0
										2004		1/0/0
										2005		1/1/0
										2006		1/2/0
										2007		1/3/0
										2008		2/0/0
										2009		2/1/0
										2010		2/2/0
										2011		2/3/0
										2013		3/1/0
										2014		3/2/0
										2015		3/3/0
										2012		3/0/0
										5016		4/0/0
										5017		4/1/0

Recording File List Save (Excel File Format)

Smart DVoiceR Manager

File Advanced Configuration Help

Smart DVoiceR Manager

Record Search (Total: 15) (Page 1/1)

No.	Call ID	Source IP	Rec StartTime	Rec EndTime	Rec
1	63292	172.16.9.60	2007-06-12 09:44:59	2007-06-12 09:46:34	00:01:35
2	63293	172.16.9.60	2007-06-12 09:46:38	2007-06-12 10:10:38	00:22:49
3	63295	172.16.9.60	2007-06-12 10:11:28	2007-06-12 10:14:34	00:03:06
4	64171	172.16.9.60	2007-06-12 13:24:09	2007-06-12 13:24:09	00:00:00
5					
6					
7					
8	64177	172.16.9.60	2007-06-12 14:04:09	2007-06-12 14:04:25	00:00:16
9	64181	172.16.9.60	2007-06-12 14:05:11		
10	64185	172.16.9.60	2007-06-12 14:34:21		
11	64186	172.16.9.60	2007-06-12 14:37:31		
12	67503	172.16.9.60	2007-06-12 16:00:00		
13	67504	172.16.9.60	2007-06-12 16:02:51		
14	67515	172.16.9.60	2007-06-12 17:03:21		
15	67517	172.16.9.60	2007-06-12 17:06:00		

Records Exporting !!! ... Cancel

Microsoft Excel - Records.xls

Export Date : 2007-06-14 오후 5:52:46

Export Count : %

Record Filter : (called_num="6015")

Call ID	Source IP	Record Start Time	Record End Time	Record	Call Dur	Callings	Callings	Called	Called L	Called F	File Name	File Size	Audio C	Me
6	63292	172.16.9.60	2007-06-12 9:44	2007-06-12 9:46	0:01:35	0:01:35	1015	3/3/0	6015	3/3/0	63292001819K	GT11U		
7	63292	172.16.9.60	2007-06-12 9:44	2007-06-12 9:46	0:01:34	0:01:35	1015	3/3/0	6015	3/3/0	63292001817K	GT11U		
8	63293	172.16.9.60	2007-06-12 9:52	2007-06-12 9:56	0:04:33	0:24:03	1015	3/3/0	6015	3/3/0	63293001281K	GT11U		
9	63293	172.16.9.60	2007-06-12 9:56	2007-06-12 9:56	0:04:33	0:24:03	1015	3/3/0	6015	3/3/0	63293001281K	GT11U		
10	63293	172.16.9.60	2007-06-12 9:57	2007-06-12 10:10	0:13:28	0:24:03	1015	3/3/0	6015	3/3/0	63293001696K	GT11U		
11	63293	172.16.9.60	2007-06-12 9:57	2007-06-12 10:10	0:13:28	0:24:03	1015	3/3/0	6015	3/3/0	63293001695K	GT11U		
12	63293	172.16.9.60	2007-06-12 9:57	2007-06-12 9:57	0:04:46	0:24:03	1015	3/3/0	6015	3/3/0	63293001248K	GT11U		
13	63293	172.16.9.60	2007-06-12 9:46	2007-06-12 9:51	0:04:46	0:24:03	1015	3/3/0	6015	3/3/0	63293001248K	GT11U		
14	63295	172.16.9.60	2007-06-12 9:46	2007-06-12 9:46	0:03:06	0:03:06	1015	3/3/0	6015	3/3/0	63295001160K	GT11U		
15	63295	172.16.9.60	2007-06-12 10:11	2007-06-12 10:14	0:03:06	0:03:06	1015	3/3/0	6015	3/3/0	63295001160K	GT11U		
16	63295	172.16.9.60	2007-06-12 10:11	2007-06-12 10:14	0:03:06	0:03:06	1015	3/3/0	6015	3/3/0	63295001160K	GT11U		
17	64171	172.16.9.60	2007-06-12 13:22	2007-06-12 13:26	0:11:39	0:11:40	1015	3/3/0	6015	3/3/0	64171001820K	GT11U		
18	64171	172.16.9.60	2007-06-12 13:22	2007-06-12 13:26	0:11:39	0:11:40	1015	3/3/0	6015	3/3/0	64171001820K	GT11U		
19	64173	172.16.9.60	2007-06-12 13:34	2007-06-12 13:36	0:02:19	0:02:19	1015	3/3/0	6015	3/3/0	64173001119K	GT11U		
20	64173	172.16.9.60	2007-06-12 13:34	2007-06-12 13:36	0:02:19	0:02:19	1015	3/3/0	6015	3/3/0	64173001119K	GT11U		
21	64175	172.16.9.60	2007-06-12 14:00	2007-06-12 14:01	0:01:26	0:01:26	1015	3/3/0	6015	3/3/0	64175001740K	GT11U		
22	64175	172.16.9.60	2007-06-12 14:00	2007-06-12 14:01	0:01:26	0:01:26	1015	3/3/0	6015	3/3/0	64175001740K	GT11U		
23	64176	172.16.9.60	2007-06-12 13:50	2007-06-12 13:52	0:01:33	0:01:33	1015	3/3/0	6015	3/3/0	64176001804K	GT11U		
24	64176	172.16.9.60	2007-06-12 13:50	2007-06-12 13:52	0:01:33	0:01:33	1015	3/3/0	6015	3/3/0	64176001803K	GT11U		
25	64177	172.16.9.60	2007-06-12 14:04	2007-06-12 14:04	0:00:16	0:00:16	1015	3/3/0	6015	3/3/0	64177001142K	GT11U		
26	64177	172.16.9.60	2007-06-12 14:04	2007-06-12 14:04	0:00:16	0:00:16	1015	3/3/0	6015	3/3/0	64177001141K	GT11U		
27	64181	172.16.9.60	2007-06-12 14:33	2007-06-12 14:33	0:28:22	0:28:23	1015	3/3/0	6015	3/3/0	641810011466K	GT11U		
28	64181	172.16.9.60	2007-06-12 14:33	2007-06-12 14:33	0:28:22	0:28:23	1015	3/3/0	6015	3/3/0	641810011466K	GT11U		
29	64181	172.16.9.60	2007-06-12 14:34	2007-06-12 14:34	0:00:00	0:00:00	1015	3/3/0	6015	3/3/0	641810011466K	GT11U		

Recording File Waveform Analyzer



Recording File Waveform Analyzer

(Repeated Play)



Recording File Waveform Analyzer

(Bookmark Play)

The screenshot displays the 'Voice WaveForm Analyzer' interface. It features two waveform plots: the top one is yellow and the bottom one is green. Both plots have a vertical axis labeled 'smpl' ranging from -20000 to 20000 and a horizontal axis with time markers from 00:00:00 to 00:03:05. The top plot has checkboxes for 'Calling Enable/Disable' and 'Called Enable/Disable'. A 'Bookmark Set' label points to a specific time on the top waveform. A 'Bookmark' label with a pushpin icon points to a specific time on the bottom waveform. A 'Play at Bookmark Position' label points to a time on the bottom waveform. A 'Bookmark List' dialog box is open, showing a table with columns 'No.', 'Name', and 'Time'. The table contains one entry: '1', 'my bookmark no1.', '00:01:05'. The dialog has buttons for 'Modify', 'Bookmark Set', 'Bookmark Delete', and 'Bookmark List'. A 'Play From Here' context menu is open over the bottom waveform, with options 'Set Bookmark' and 'Bookmark List'. The bottom of the interface includes a control bar with play, pause, and stop buttons, a 'Repeat Selection' button, and a 'Duration' display showing '00:00:00 / 00:03:06'.

No.	Name	Time
1	my bookmark no1.	00:01:05

Recording File Waveform Analyzer

(Column Side Zooming)



Recording File Waveform Analyzer

(Row Side Zooming)

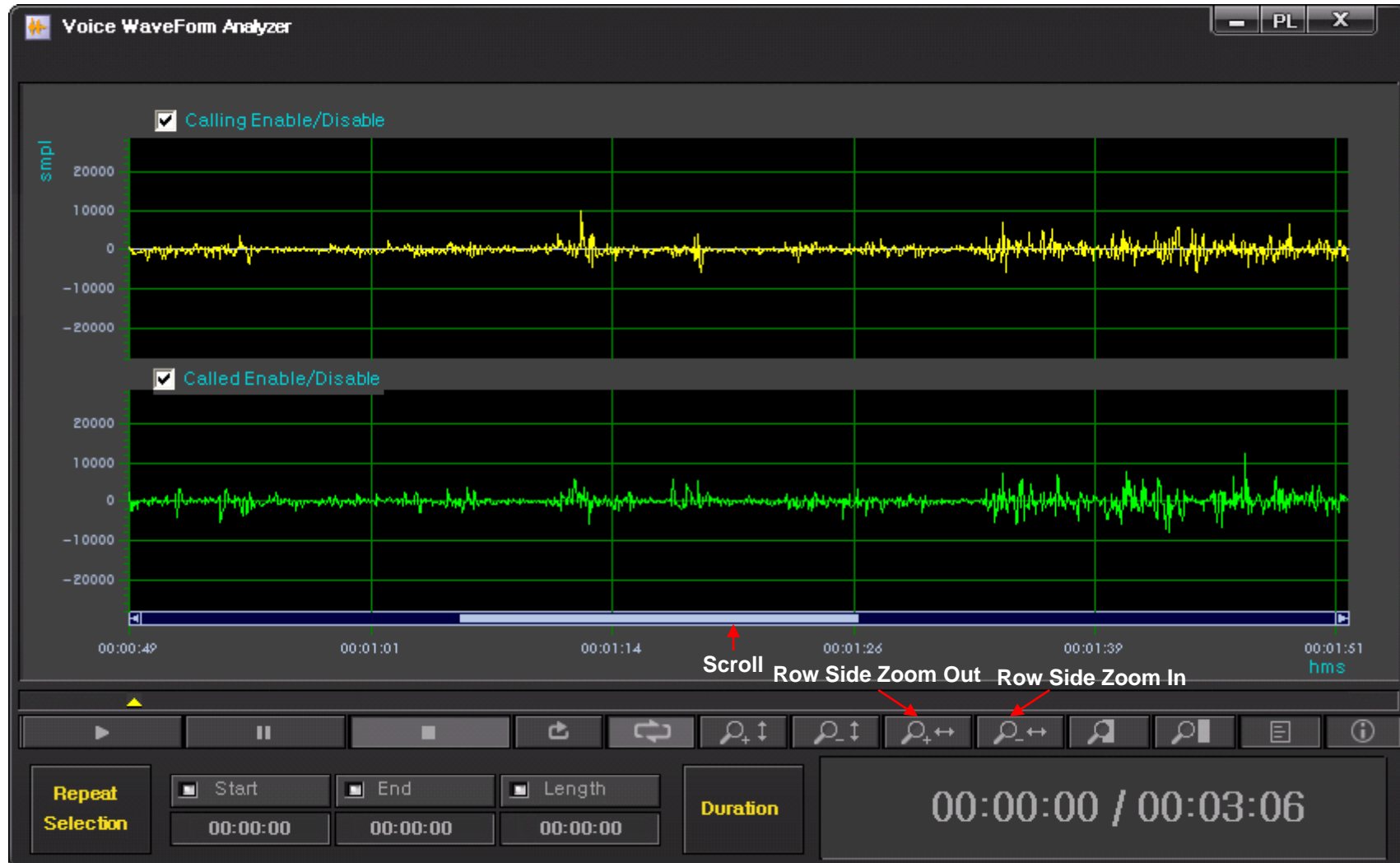

Recording File Waveform Analyzer

(Region Zooming)

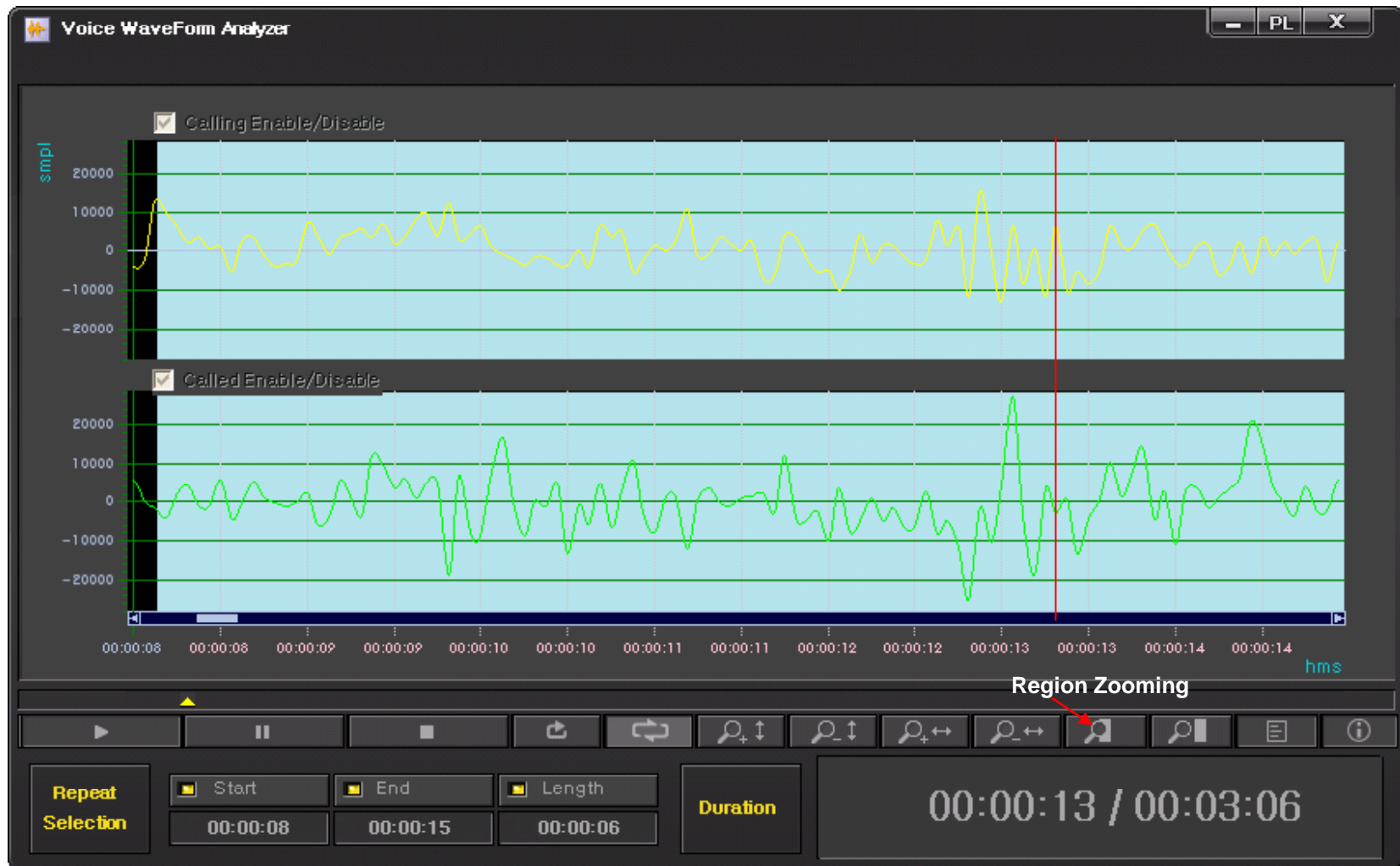

Recording File Waveform Analyzer

(Call Info. Display)

The screenshot displays the 'Voice WaveForm Analyzer' application window. The main interface features two waveform plots: a top plot with a yellow waveform and a bottom plot with a green waveform. A central 'Record Information' dialog box is open, displaying the following data:

Record Information	
Start Time	2007-06-12 10:11:28
End Time	2007-06-12 10:14:34
Record Duration	00:03:06
Record Memo	<input type="text"/>

Call Information	
Initiated Time	2007-06-12 10:13:15
Established Time	2007-06-12 10:13:16
Disconnected Time	2007-06-12 10:16:24
Call Duration	00:03:08

Calling Party	
Number	1015
User	
Codec	G711U
Directory	/mnt/hda1/callrecfiles
FileSize	1606k

Called Party	
Number	6015
User	
Codec	G711U
Directory	/mnt/hda1/callrecfiles
FileSize	1606k

At the bottom of the window, there is a control bar with playback buttons (play, pause, stop, etc.) and a 'Call Info. Display' button. Below the control bar, a 'Repeat Selection' section shows 'Start' (00:00:10), 'End' (00:00:11), and 'Length' (00:00:01). A 'Duration' section shows '00:00:11 / 00:03:06'. The text 'Original View Mode' is also visible.

Live Call Recording List and Monitoring

The screenshot displays the Smart DVoiceR Manager software interface. The main window is titled "Smart DVoiceR Manager" and features a menu bar (File, Advanced, Configuration, Help) and a toolbar. The central area is labeled "Current Call List Display" and "Live Play". Below this, there is a "Record Session" section with a "Refresh Interval" set to 5 seconds and an "Apply" button. The main display is a table of call records with columns for No., Call ID, Source IP, Rec StartTime, Initiated Time, Established Time, Call Duration, Calling Num, Calling User, Calling SI..., and Calling Trans... A "List Update Time" indicator is visible above the table. A "Record Information" window is overlaid on the table, showing details for a call with ID 3006, including start and end times, duration, and calling/called party information.

No.	Call ID	Source IP	Rec StartTime	Initiated Time	Established Time	Call Duration	Calling Num	Calling User	Calling SI...	Calling Trans...	C
1	46551	172.17.213.100	2007-06-13 15:20:42	2007-06-13 15:2...	2007-06-13 15:22:38	00:00:11	5009		2/1/0	G7231_63->...	2
2	46552	172.17.213.100	2007-06-13 15:20:42	2007-06-13 15:2...	2007-06-13 15:22:38	00:00:11	5007		1/3/0	G7231_63->...	2
3	46553	172.17.213.100	2007-06-13 15:20:43	2007-06-13 15:2...	2007-06-13 15:22:39	00:00:10	5013		3/1/0	G7231_63->...	2
4	46558	172.17.213.100	2007-06-13 15:20:44	2007-06-13 15:2...	2007-06-13 15:22:39	00:00:09	3015		7/3/0	G7231_63->...	5
5	46554	172.17.213.100	2007-06-13 15:20:44	2007-06-13 15:2...	2007-06-13 15:22:39	00:00:09	5011		2/3/0	G7231_63->...	2
6	46555	172.17.213.100	2007-06-13 15:20:44	2007-06-13 15:2...	2007-06-13 15:22:39	00:00:09	5014		3/2/0	G7231_63->...	2
7	46556	172.17.213.100	2007-06-13 15:20:44	2007-06-13 15:2...	2007-06-13 15:22:39	00:00:09	5011		3/3/0	G7231_63->...	2
8	46559	172.17.213.100	2007-06-13 15:20:45	2007-06-13 15:2...	2007-06-13 15:22:39	00:00:09	5011		7/2/0	G7231_63->...	5
9	46557	172.17.213.100	2007-06-13 15:20:45	2007-06-13 15:2...	2007-06-13 15:22:39	00:00:09	5011		0/3/0	G7231_63->...	2
10	46560	172.17.213.100	2007-06-13 15:20:46	2007-06-13 15:2...	2007-06-13 15:22:39	00:00:09	5011		7/0/0	G7231_63->...	5
11	46561	172.17.213.100	2007-06-13 15:20:47	2007-06-13 15:2...	2007-06-13 15:22:39	00:00:09	5011		1/0/0	G7231_63->...	2
12	46546	172.17.213.100	2007-06-13 15:20:34	2007-06-13 15:2...	2007-06-13 15:22:39	00:00:09	5011		4/3/0	G7231_63->...	5
13	46563	172.17.213.100	2007-06-13 15:20:47	2007-06-13 15:2...	2007-06-13 15:22:39	00:00:09	5011		6/0/0	G7231_63->...	5
14	46562	172.17.213.100	2007-06-13 15:20:50	2007-06-13 15:2...	2007-06-13 15:22:39	00:00:09	5011		1/2/0	G7231_63->...	2
15	46545	172.17.213.100	2007-06-13 15:20:36	2007-06-13 15:2...	2007-06-13 15:22:39	00:00:09	5011		3/0/0	G7231_63->...	2
16	46564	172.17.213.100	2007-06-13 15:20:50	2007-06-13 15:2...	2007-06-13 15:22:39	00:00:09	5011		4/0/0	G7231_63->...	5
17	46565	172.17.213.100	2007-06-13 15:20:51	2007-06-13 15:2...	2007-06-13 15:22:39	00:00:09	5011		5/3/0	G7231_63->...	5
18	46547	172.17.213.100	2007-06-13 15:20:41	2007-06-13 15:2...	2007-06-13 15:22:39	00:00:09	5011		0/2/0	G7231_63->...	2
19	46566	172.17.213.100	2007-06-13 15:20:52	2007-06-13 15:2...	2007-06-13 15:22:39	00:00:09	5011		6/2/0	G7231_63->...	5
20	46548	172.17.213.100	2007-06-13 15:20:41	2007-06-13 15:2...	2007-06-13 15:22:39	00:00:09	5011		1/1/0	G7231_63->...	2
21	46567	172.17.213.100	2007-06-13 15:20:52	2007-06-13 15:2...	2007-06-13 15:22:39	00:00:09	5011		4/2/0	G7231_63->...	5
22	46549	172.17.213.100	2007-06-13 15:20:41	2007-06-13 15:2...	2007-06-13 15:22:39	00:00:09	5011		2/0/0	G7231_63->...	2
23	46568	172.17.213.100	2007-06-13 15:20:52	2007-06-13 15:2...	2007-06-13 15:22:39	00:00:09	5011		5/2/0	G7231_63->...	5
24	46569	172.17.213.100	2007-06-13 15:20:52	2007-06-13 15:2...	2007-06-13 15:22:39	00:00:09	5011		6/1/0	G7231_63->...	5
25	46570	172.17.213.100	2007-06-13 15:20:52	2007-06-13 15:2...	2007-06-13 15:22:39	00:00:09	5011		5/0/0	G7231_63->...	5
26	46550	172.17.213.100	2007-06-13 15:20:42	2007-06-13 15:2...	2007-06-13 15:22:39	00:00:09	5011		0/0/0	G7231_63->...	2
27	46573	172.17.213.100	2007-06-13 15:20:53	2007-06-13 15:2...	2007-06-13 15:22:39	00:00:09	5011		4/1/0	G7231_63->...	5
28	6208	172.16.9.60	2007-06-13 15:20:30	2007-06-13 15:2...	2007-06-13 15:22:39	00:00:09	5011		4/2/0	G729A_8->G...	2
29	6209	172.16.9.60	2007-06-13 15:20:30	2007-06-13 15:2...	2007-06-13 15:22:39	00:00:09	5011		5/0/0	G729A_8->G...	2
30	6223	172.16.9.60	2007-06-13 15:20:45	2007-06-13 15:2...	2007-06-13 15:22:39	00:00:09	5011		1/3/0	G729A_8->G...	6
31	6213	172.16.9.60	2007-06-13 15:20:32	2007-06-13 15:2...	2007-06-13 15:22:39	00:00:09	5011		4/0/0	G729A_8->G...	2
32	6214	172.16.9.60	2007-06-13 15:20:32	2007-06-13 15:2...	2007-06-13 15:22:39	00:00:09	5011		4/3/0	G729A_8->G...	2
33	6215	172.16.9.60	2007-06-13 15:20:32	2007-06-13 15:2...	2007-06-13 15:22:39	00:00:09	5011		4/1/0	G729A_8->G...	2
34	6224	172.16.9.60	2007-06-13 15:20:49	2007-06-13 15:2...	2007-06-13 15:22:42	00:00:04	1006		1/2/0	G729A_8->G...	6
35	5882	172.16.9.60	2007-06-13 15:08:56	2007-06-13 15:1...	2007-06-13 15:10:48	00:11:57	1015		3/3/0	G729A_8->G...	6
36	6220	172.16.9.60	2007-06-13 15:20:41	2007-06-13 15:2...	2007-06-13 15:22:35	00:00:12	1004		1/0/0	G729A_8->G...	6
37	6221	172.16.9.60	2007-06-13 15:20:42	2007-06-13 15:2...	2007-06-13 15:22:35	00:00:11	1005		1/1/0	G729A_8->G...	6

Event Management (Configuration)

Smart DVoiceR Manager

File Advanced Configuration Help

Smart DVoiceR Manager AddPac Technology

Smart DVoiceR Manager

- Smart DVoiceR Manager
 - User Management
 - Users
 - Device Management
 - Smart Recording Server
 - Smart Recording Terminal
 - Recording Management
 - Record Search
 - Record Session
 - Event & Monitoring
 - Event Configuration**
 - Event Monitoring
 - System Monitoring
 - Event History
 - Recording Board
 - Board Users
 - Board Groups
 - Map List

Event Configuration

Event Source

Host : 172.16.4.22 ← **Server IP address**

Listen Port : 514 ← **Event Port Number**

1. Emergency
The presence of a condition that has either caused the system to become unstable or has crashed the system.

2. Error
Error events are warnings of conditions that will affect the performance of the MX.

← **Realtime event level Setting**

Event Filter | Event Logging Filter

+ Event filter setting for source.

Select / Deselect All

Category	Severity	Description
<input checked="" type="checkbox"/> recording	Warning	recording
<input checked="" type="checkbox"/> play	Warning	play
<input checked="" type="checkbox"/> system	Warning	system

Use Emergency Sound

OK Cancel

Event Configuration

Event Source

Host : 172.16.4.22

Listen Port : 514

1. Emergency
The presence of a condition that has either caused the system to become unstable or has crashed the system.

2. Error
Error events are warnings of conditions that will affect the performance of the MX.

← **Event logging level Setting**

Event Filter | Event Logging Filter

+ Event filter setting for logging.

Select / Deselect All

Category	Severity	Description
<input checked="" type="checkbox"/> recording	Warning	recording
<input checked="" type="checkbox"/> play	Warning	play
<input checked="" type="checkbox"/> system	Warning	system

Use Emergency Sound

OK Cancel

2007-06-14 오후 4:25:35 Ver. 1.0.2720 172.16.4.22:9200 root

Event Management (Monitoring)

The screenshot displays the Smart DVoiceR Manager interface. The main window shows a list of call records with columns for No., Call ID, Source IP, Rec StartTime, Initiated Time, Established Time, Call Duration, Calling Num, and Calli... The interface includes a menu bar (File, Advanced, Configuration, Help), a toolbar, and a sidebar with navigation options like User Management, Device Management, Recording Management, and Event & Monitoring. A 'Refresh Interval' of 5 seconds is set. Red arrows point to specific features: 'Event Display Window' points to the sidebar, 'Event level Configuration Window' points to the top right, 'Event Display Window Clear' points to a button in the bottom right, and 'Event Receiving Pause' points to a 'Pause' button in the bottom right.

No.	Call ID	Source IP	Rec StartTime	Initiated Time	Established Time	Call Duration	Calling Num	Calli...
1	690	172.17.213.100	2007-06-14 16:25:24	2007-06-14 16:27:25	2007-06-14 16:27:29	00:00:20	5012	
2	693	172.17.213.100	2007-06-14 16:25:24	2007-06-14 16:27:28	2007-06-14 16:27:29	00:00:20	5005	
3	694	172.17.213.100	2007-06-14 16:25:25	2007-06-14 16:27:29	2007-06-14 16:27:30	00:00:19	5001	
4	695	172.17.213.100	2007-06-14 16:25:26	2007-06-14 16:27:29	2007-06-14 16:27:31	00:00:18	5006	
5	696	172.17.213.100	2007-06-14 16:25:26	2007-06-14 16:27:30	2007-06-14 16:27:31	00:00:18	5007	
6	697	172.17.213.100	2007-06-14 16:25:27	2007-06-14 16:27:31	2007-06-14 16:27:32	00:00:17	5008	
7	698	172.17.213.100	2007-06-14 16:25:28	2007-06-14 16:27:32	2007-06-14 16:27:33	00:00:16	5009	
8	699	172.17.213.100	2007-06-14 16:25:30	2007-06-14 16:27:34	2007-06-14 16:27:35	00:00:14	5011	
9	700	172.17.213.100	2007-06-14 16:25:31	2007-06-14 16:27:34	2007-06-14 16:27:36	00:00:13	5010	
10	701	172.17.213.100	2007-06-14 16:25:32	2007-06-14 16:27:36	2007-06-14 16:27:37	00:00:12	5013	
11	702	172.17.213.100	2007-06-14 16:25:34	2007-06-14 16:27:37	2007-06-14 16:27:38	00:00:10	5014	
12	703	172.17.213.100	2007-06-14 16:25:38	2007-06-14 16:27:42	2007-06-14 16:27:43	00:00:06	5015	
13	704	172.17.213.100	2007-06-14 16:25:39	2007-06-14 16:27:43	2007-06-14 16:27:44	00:00:05	3000	
14	705	172.17.213.100	2007-06-14 16:25:40	2007-06-14 16:27:44	2007-06-14 16:27:45	00:00:04	3001	
15	706	172.17.213.100	2007-06-14 16:25:42	2007-06-14 16:27:45	2007-06-14 16:27:46	00:00:02	3002	
16	684	172.17.213.100	2007-06-14 16:25:17	2007-06-14 16:27:20	2007-06-14 16:27:21	00:00:27	3012	
17	707	172.17.213.100	2007-06-14 16:25:43	2007-06-14 16:27:46	2007-06-14 16:27:47	00:00:01	3003	
18	686	172.17.213.100	2007-06-14 16:25:18	2007-06-14 16:27:21	2007-06-14 16:27:22	00:00:26	3013	
19	708	172.17.213.100	2007-06-14 16:25:44	2007-06-14 16:27:47	2007-06-14 16:27:49	00:00:00	3004	
20	687	172.17.213.100	2007-06-14 16:25:18	2007-06-14 16:27:22	2007-06-14 16:27:23	00:00:26	3014	
21	685	172.17.213.100	2007-06-14 16:25:19	2007-06-14 16:27:23	2007-06-14 16:27:24	00:00:25	5000	
22	689	172.17.213.100	2007-06-14 16:25:20	2007-06-14 16:27:23	2007-06-14 16:27:24	00:00:24	3015	

Event Monitoring window details:

DateTime	Host	Severity	Module	Description
Jun 14 07:25:43	172.16.4.22	Informational	recording	recording stopping ; call_id = 682, ip = 172.17.213.100, mac_addr = 0002,a403,cc82
Jun 14 07:25:43	172.16.4.22	Informational	recording	Stop Recording, bind id:2003
Jun 14 07:25:43	172.16.4.22	Informational	recording	new recording starting ; call_id = 707, ip = 172.17.213.100, mac_addr = 0002,a403,cc82
Jun 14 07:25:43	172.16.4.22	Informational	recording	Start Recording, bind id:2003
Jun 14 07:25:44	172.16.4.22	Informational	recording	recording stopping ; call_id = 683, ip = 172.17.213.100, mac_addr = 0002,a403,cc82
Jun 14 07:25:44	172.16.4.22	Informational	recording	Stop Recording, bind id:2003
Jun 14 07:25:44	172.16.4.22	Informational	recording	new recording starting ; call_id = 708, ip = 172.17.213.100, mac_addr = 0002,a403,cc82
Jun 14 07:25:44	172.16.4.22	Informational	recording	Start Recording, bind id:2003
Jun 14 07:25:44	172.16.4.22	Debug	system	get current recording session ;
Jun 14 07:25:44	172.16.4.22	Informational	recording	new recording starting ; call_id = 709, ip = 172.17.213.100, mac_addr = 0002,a403,cc82
Jun 14 07:25:44	172.16.4.22	Informational	recording	Start Recording, bind id:2003
Jun 14 07:25:45	172.16.4.22	Informational	recording	recording stopping ; call_id = 684, ip = 172.17.213.100, mac_addr = 0002,a403,cc82
Jun 14 07:25:45	172.16.4.22	Informational	recording	Stop Recording, bind id:2003
Jun 14 07:25:45	172.16.4.22	Informational	recording	new recording starting ; call_id = 710, ip = 172.17.213.100, mac_addr = 0002,a403,cc82
Jun 14 07:25:45	172.16.4.22	Informational	recording	Start Recording, bind id:2003
Jun 14 07:25:46	172.16.4.22	Informational	recording	recording stopping ; call_id = 686, ip = 172.17.213.100, mac_addr = 0002,a403,cc82
Jun 14 07:25:46	172.16.4.22	Informational	recording	Stop Recording, bind id:2003
Jun 14 07:25:46	172.16.4.22	Debug	system	get current recording session ;

Event Management

(System Monitoring)

The screenshot displays the 'System Monitoring' window of the Smart DVoiceR Manager. The interface includes a navigation tree on the left, a main performance dashboard, and a status bar at the bottom.

Performance Metrics:

- CPU Usage:** 40 %
- Memory Usage:** 61 MB
- Trans Codec Usage:** Max 128, 54

System Statistics:

CPU	
Total(%)	100
Used(%)	0

Memory	
Total	254752 KB
Available	171860 KB
Used	82892 KB
Used(%)	32,54

Transcoding Channel	
Max	128
Used	0

HDD	
Total	304273 MB
Available	138124 MB
Used	166149 MB
Used(%)	54,61

Disk Usage:

- rootfs (/):** 2.00 GB / 3.00 GB
- /dev/hda1 (/mnt/hda1):** 139.00 GB / 300.00 GB

Status Bar: 2007-06-14 오후 4:38:08 | Ver. 1,0,2720 | 172, 16, 4, 22:9200 | root

Event Management

(Event History)

Event Search Time Setting

Start : 2007-06-14 00:00:00
End : 2007-06-14 23:59:59

Event category

Recording : Debug
 Play : Debug
 System : Debug

Search Condition Setting

Filter Name : Event
Rule : IsExactly
Search :

Event History Table

No.	Event Time	Host	Category	Severity	Event
22	2007-06-14 15:14:21	172.16.4.22	recording	Informational	recording stopping : call_id = 0, ip = , mac_addr =
23	2007-06-14 15:14:21	172.16.4.22	recording	Informational	recording stopping : call_id = 0, ip = , mac_addr =
24	2007-06-14 15:15:01	172.16.4.22	recording	Informational	new recording starting : call_id = 9702, ip = 172.16.9...
25	2007-06-14 15:15:32	172.16.4.22	recording	Informational	new recording starting : call_id = 9784, ip = 172.16.9...
26	2007-06-14 15:15:32	172.16.4.22	recording	Informational	new recording starting : call_id = 9788, ip = 172.16.9...
27	2007-06-14 15:15:33	172.16.4.22	recording	Informational	new recording starting : call_id = 9790, ip = 172.16.9...
28	2007-06-14 15:15:35	172.16.4.22	recording	Informational	new recording starting : call_id = 9792, ip = 172.16.9...
29	2007-06-14 15:15:37	172.16.4.22	recording	Informational	new recording starting : call_id = 9794, ip = 172.16.9...
30	2007-06-14 15:15:39	172.16.4.22	recording	Informational	new recording starting : call_id = 9797, ip = 172.16.9...
31	2007-06-14 15:15:40	172.16.1.48	system	Debug	getChannelUsage : client ip = 172.16.1.48, port = 1824
32	2007-06-14 15:15:43	172.16.1.48	system	Debug	get system information requested : cpu = 15%, mem...
33	2007-06-14 15:15:44	172.16.1.48	system	Debug	get system information requested : cpu = 20%, mem...
34	2007-06-14 15:15:45	172.16.1.48	system	Debug	get system information requested : cpu = 20%, mem...
35	2007-06-14 15:15:45	172.16.1.48	system	Debug	get transcoding channel usage :
36	2007-06-14 15:15:46	172.16.1.48	system	Debug	getChannelUsage : client ip = 172.16.1.48, port = 1824
37	2007-06-14 15:15:47	172.16.1.48	system	Debug	get system information requested : cpu = 1%, memor...
38	2007-06-14 15:15:47	172.16.1.48	system	Debug	get transcoding channel usage :
39	2007-06-14 15:15:48	172.16.1.48	system	Debug	getChannelUsage : client ip = 172.16.1.48, port = 1824
40	2007-06-14 15:15:49	172.16.1.48	system	Debug	getChannelUsage : client ip = 172.16.1.48, port = 1824
41	2007-06-14 15:15:50	172.16.1.48	system	Debug	getChannelUsage : client ip = 172.16.1.48, port = 1824
42	2007-06-14 15:15:51	172.16.1.48	system	Debug	get system information requested : cpu = 16%, mem...
43	2007-06-14 15:15:51	172.16.1.48	system	Debug	get transcoding channel usage :
44	2007-06-14 15:15:52	172.16.1.48	system	Debug	getChannelUsage : client ip = 172.16.1.48, port = 1824
45	2007-06-14 15:15:53	172.16.1.48	system	Debug	getChannelUsage : client ip = 172.16.1.48, port = 1824
46	2007-06-14 15:15:54	172.16.1.48	system	Debug	getChannelUsage : client ip = 172.16.1.48, port = 1824
47	2007-06-14 15:15:55	172.16.1.48	system	Debug	getChannelUsage : client ip = 172.16.1.48, port = 1824
48	2007-06-14 15:15:56	172.16.1.48	system	Debug	getChannelUsage : client ip = 172.16.1.48, port = 1824
49	2007-06-14 15:15:57	172.16.1.48	system	Debug	get system information requested : cpu = 16%, mem...
50	2007-06-14 15:15:57	172.16.1.48	system	Debug	get transcoding channel usage :
51	2007-06-14 15:15:58	172.16.4.22	recording	Informational	recording stopping : call_id = 9785, ip = 172.16.9.60, ...
52	2007-06-14 15:15:58	172.16.1.48	system	Debug	get system information requested : cpu = 8%, memor...
53	2007-06-14 15:15:58	172.16.1.48	system	Debug	get transcoding channel usage :

Recording Board Management

(Call User Registration)

Smart DVoiceR Manager

File Advanced Configuration Help

Smart DVoiceR Manager Board Users

No.	User ID	Name	Phone Number
1	2002	james lee	2002
2	bmlee	bmlee	6002
3	cykim	cykim	1019
4	dhkim	dhkim	5075
5	hgyang	hgyang	2006
6	jhjeon	jhjeon	6008
7	jhkwon	jhkwon	1002
8	jhlee	jhlee	026
9	jhsong	jhsong	5
10	jschoi	jschoi	5
11	jwwoo	jwwoo	8
12	jkim	jkim	0
13	jypark	jypark	7
14	kkim	kkim	3
15	kscho	kscho	5
16	kswoo	kswoo	2004
17	kuhan	kuhan	1210
18	mhlee	mhlee	2007
19	mjlee	mjlee	1008
20	mkkim	mkkim	1212
21	mwlee	mwlee	1006
22	ohs	ohs	6015
23	phkwon	kwon young phil	6006
24	smkim	smkim	1003
25	syk	soyoung kim	1027
26	wshwang	senior manager	6005
27	yhj	yhj	1016
28	ymchoi	ymchoi(QA assistant)	6007
29	yslee	senior assistant	1015

Import Board Users

Filter: Filter Name Rule Word Advanced Search Find

Phone Number [is exactly]

User ID	Name	Phone Number
lew	lew	1000
kslee	kslee	1001
slms	slms	1003
sykim	sykim	1009
syyl	syyl	1011
bjang	bjang	1015
knkim	knkim	1016
weschoi	weschoi	1101
kwshin	kwshin	1102
ngkim	ngkim	1105
weschoi	weschoi	1106
shim_h...	shim_h...	1107
dwshin	dwshin	1108

Add Board User

User

User ID: james
 User Name: james brahms
 Description: quality assurance dev.
 Group: SE

Phone Numbers

5000

6000

Call User List Import

New Call User Registration

2007-06-15 오후 7:38:49 Ver. 1.0.2722 172,16,4,22:9200 root

Recording Board Management

(Background Image (MAP) Selection)

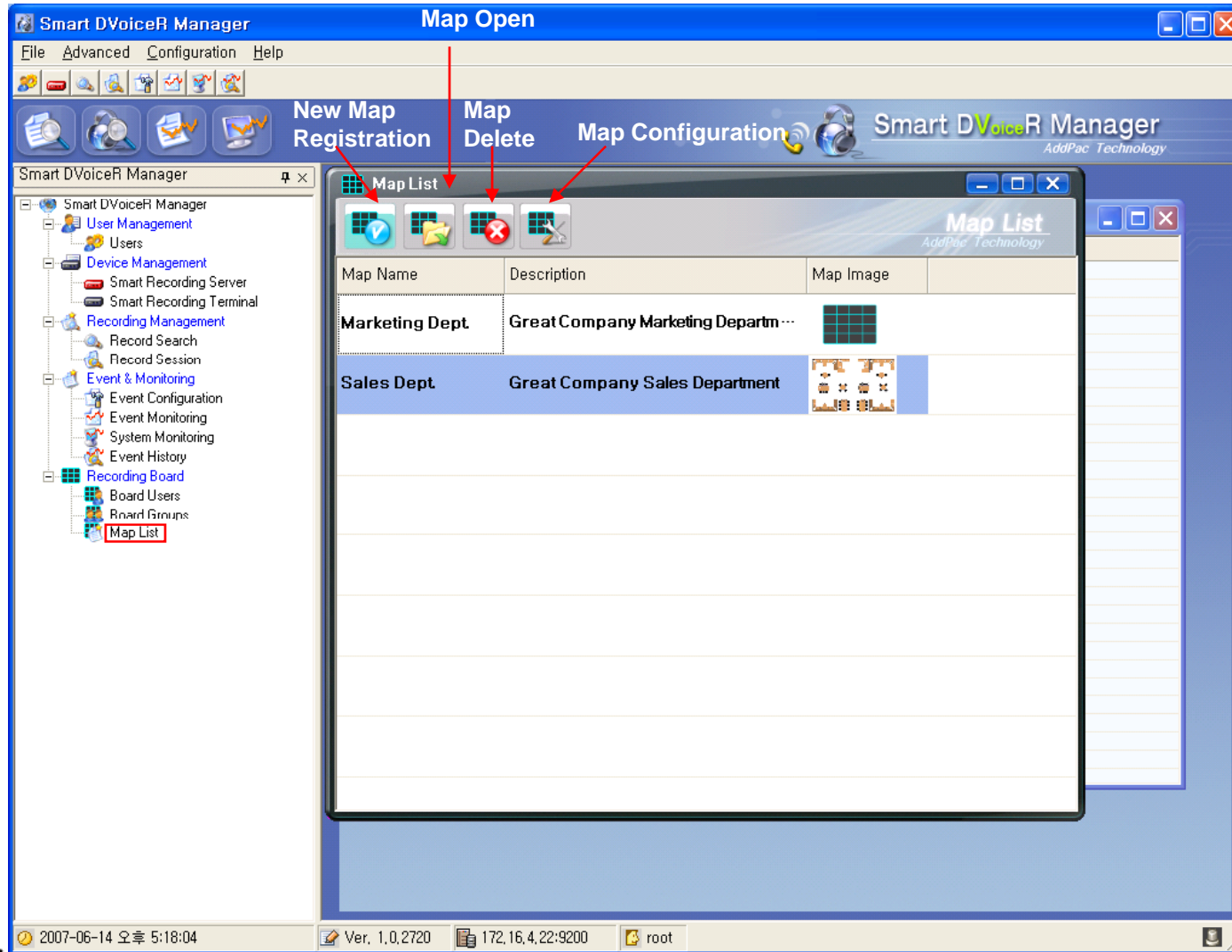

Recording Board Management (Layout Configuration)

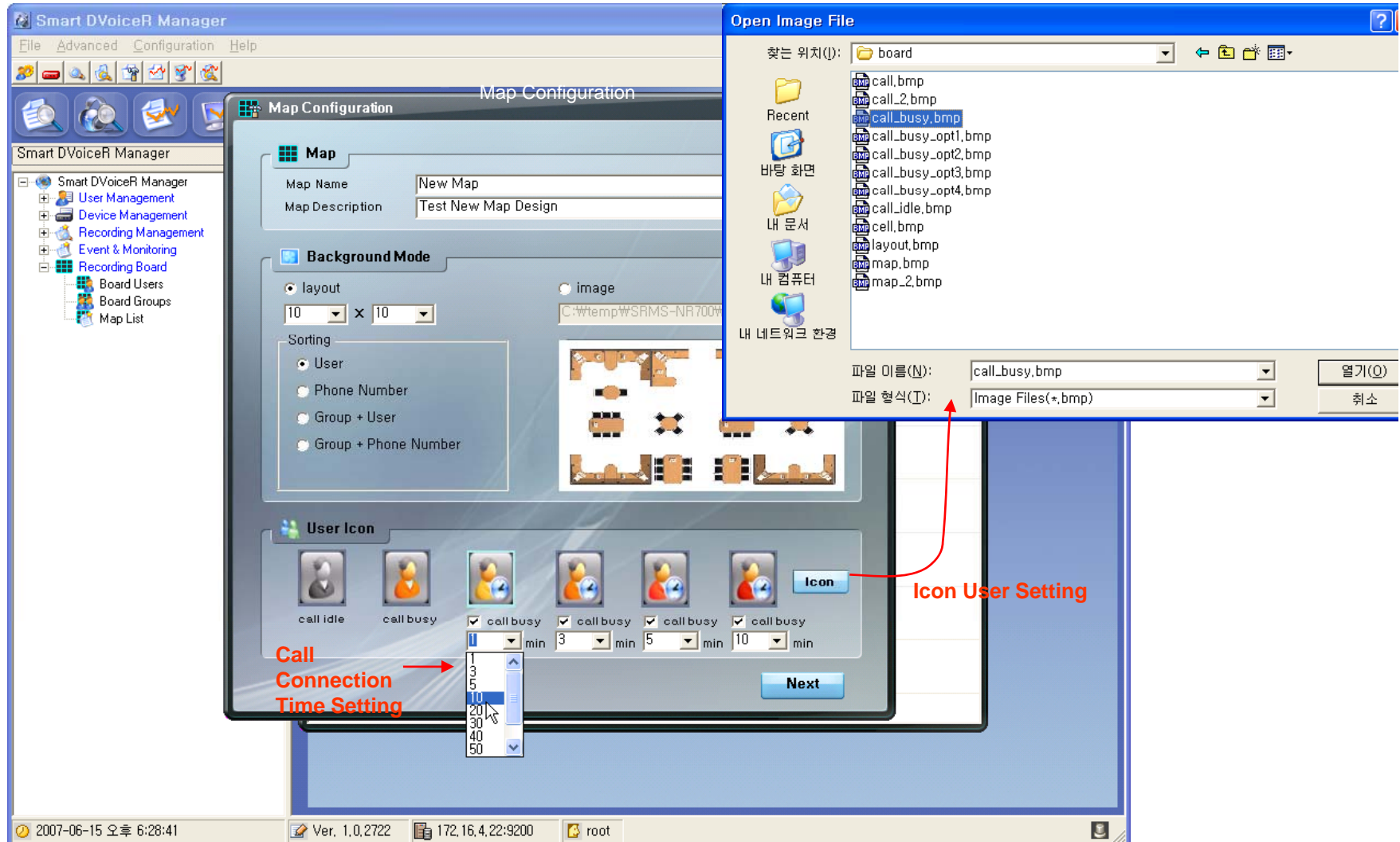

Recording Board Management

(Live Monitoring)

Map Configuration (edit)

Map Information Save

Dynamic Call Status Display (Icon Color)

Call Status Display

Call Connection Time Icon Display

Recording Board (Marketing Dept.)

AddPac Recording Board AddPac Technology

Save Config Auto-Insert Edit Map

kwon young p jhwon senior manage kkim dhkim smkim ohs mwlee mjlee bmlee

senior assistan jhjeon kscho jschoi

Map Name: Marketing Dept. Session Information: Total 14 Idle 6 Busy 8 User Icon: Call Idle Call Busy Over 1 minutes Over 3 minutes Over 5 minutes Over 10 minutes

Recording Board Management

(Call User Insert/Remove in MAP)

The screenshot displays the 'Recording Board (Marketing Dept.)' interface. At the top, there is a menu bar with 'Save', 'Config', 'Auto-Insert', and 'Edit Map' buttons. A red arrow points from the 'Edit Map' button to the text 'Call User List Display ON/OFF'. Below the menu is a grid of call user icons. A red dashed arrow labeled 'insert' points from the 'Board Users' list on the right to a specific user icon in the grid. Another red dashed arrow labeled 'remove' points from the same user icon in the grid back to the 'Board Users' list. The 'Board Users' list on the right is organized into a tree structure with categories like BCN, NMS, and SE, and lists individual user names with status icons. At the bottom, there is a status bar with 'Map Name' (Marketing Dept.), 'Session Information' (Total 14, Idle 4, Busy 10), and 'User Icon' settings for Call Idle and Call Busy with duration thresholds (Over 1, 3, 5, 10 minutes).

Recording Board Management

(Background Image Loading)

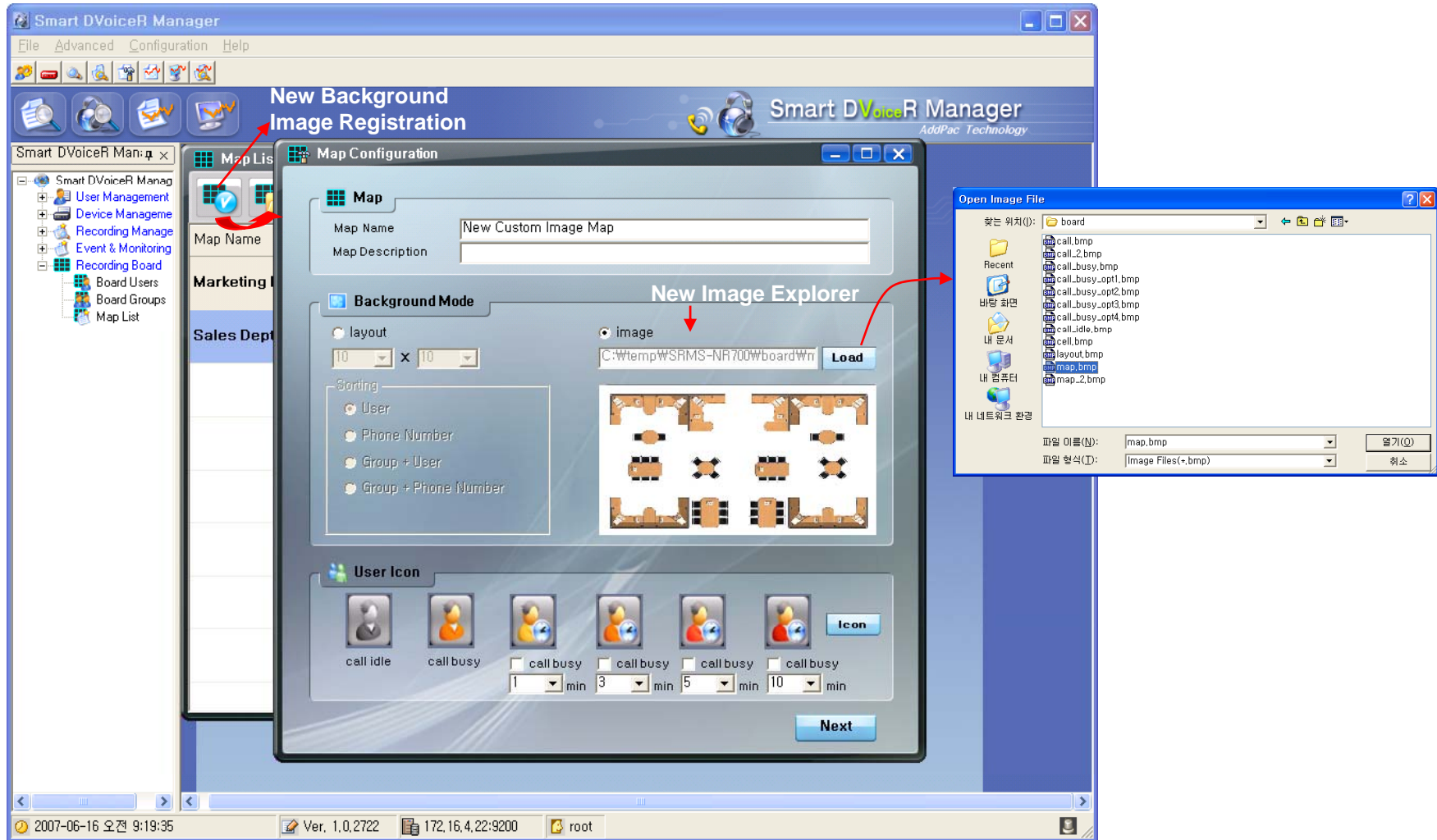

Recoding Board Management

(Call User Registration in Background MAP image)

Recording Board(New Custom Image Map)

AddPac Recording Board
AddPac Technology

Save Config Auto-Insert Edit Map

Board Users

- BCN
 - jhjeon
 - kkim
 - kwon young ...
 - mwlee
 - ohs
 - senior ass...
 - senior mana...
 - smkim
- NMS
 - jhkwon
 - jschoi
 - mjlee
- SE
 - bmlee
 - dhkim
 - kscho

Map Name: New Custom Image Map

Session Information: Total 12, Idle 2, Busy 10

User Icon: Call Idle, Call Busy, Over 1 minutes, Over 3 minutes, Over 5 minutes, Over 10 minutes

Smart File Manager

(Login)



Smart File Manager

(Recorded Call List Search)

Smart File Manager
File Management Help

AddPac Smart File Manager
AddPac Technology

Search Target: Remote Database Start: 2007년 5월 4일 금요일 End: 2007년 5월 4일 금요일 Search Advanced (Total: 1255) (Page 1/2)

Remote Database (172.17.101.251)

Start Time	End Time	Duration	Calling Number	Calling User	Called Number	Called User	Recording Source
2007-05-04 05:28:40	2007-05-04 05:29:07	00:00:27	5000		1015		172.17.213.100
2007-05-04 05:29:26	2007-05-04 05:29:53	00:00:27	5000		1015		172.17.213.100
2007-05-04 05:30:02	2007-05-04 05:30:29	00:00:27	5000		1015		172.17.213.100
2007-05-04 05:30:56	2007-05-04 05:31:34	00:00:38	5000		1015		172.17.213.100
2007-05-04 05:32:09	2007-05-04 05:32:36	00:00:27	5000		1015		172.17.213.100
2007-05-04 05:33:12	2007-05-04 05:33:39	00:00:27	5000		1015		172.17.213.100
2007-05-04 05:34:24	2007-05-04 05:34:51	00:00:27	5000		1015		172.17.213.100
2007-05-04 05:35:18	2007-05-04 05:35:45	00:00:27	5000		1015		172.17.213.100
2007-05-04 05:36:21	2007-05-04 05:36:48	00:00:27	5000		1015		172.17.213.100
2007-05-04 05:36:57	2007-05-04 05:37:24	00:00:27	5000		1015		172.17.213.100
2007-05-04 05:37:33	2007-05-04 05:38:00	00:00:27	5000		1015		172.17.213.100

Local Database (127.0.0.1)

Start Time	End Time	Duration	Calling Number	Calling User	Called Number	Called User	Recording Source	Men
------------	----------	----------	----------------	--------------	---------------	-------------	------------------	-----

Status Display

2007-05-04 오후 9:16:57 version 1.0.2651 172.17.101.251:9200 Administrator Waiting Next Backup Time(2007-05-06 오전 3:00:00)

Smart File Manager

(Configuration and Search Filter)

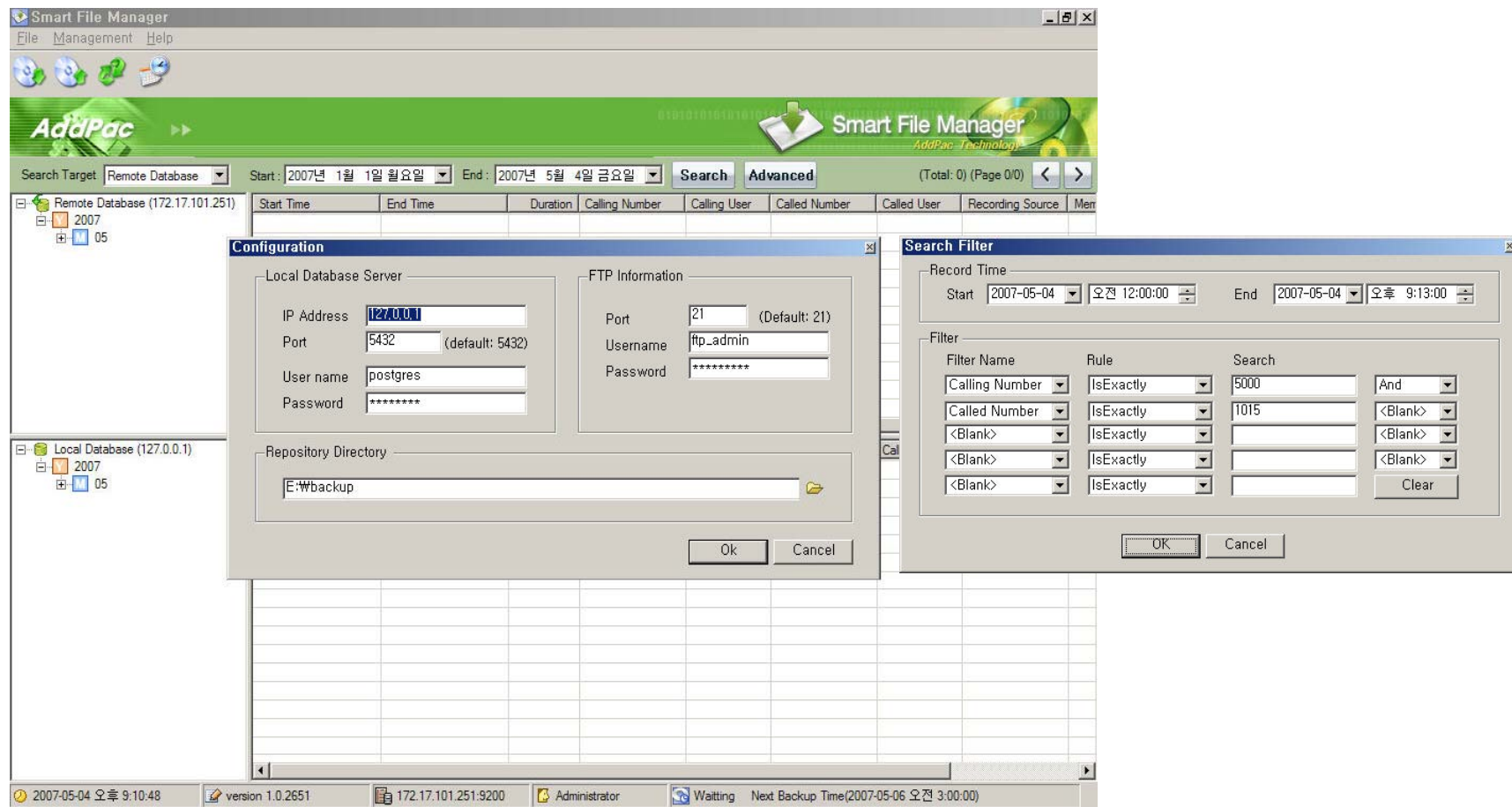

Smart File Manager

(Call List Properties)

The screenshot displays the Smart File Manager interface. The main window shows a search for call records in a Remote Database. A context menu is open over a selected record, with the 'Properties' option highlighted. A 'Recording Session Information' dialog box is also open, showing details for two recording sessions.

Start Time	End Time	Duration	Calling Number	Calling User	Called Number	Called User	Recording Source
2007-05-04 05:28:40	2007-05-04 05:29:07	00:00:27	5000		1015		172.17.213.100
2007-05-04 05:28:41	2007-05-04 05:29:08	00:00:27	5012		1027		172.17.213.100
2007-05-04 05:28:42	2007-05-04 05:29:09	00:00:27	6007		1007		172.17.213.100
2007-05-04 05:28:42	2007-05-04 05:29:09	00:00:27	6001		1001		172.17.213.100
2007-05-04 05:28:46	2007-05-04 05:29:13	00:00:27	6008		1008		172.17.213.100
2007-05-04 05:28:47	2007-05-04 05:29:14	00:00:27	5013		1028		172.17.213.100
2007-05-04 05:28:50	2007-05-04 05:29:17	00:00:27	6011		1011		172.17.213.100
2007-05-04 05:28:54	2007-05-04 05:29:21	00:00:27	5005		1020		172.17.213.100
2007-05-04 05:28:58	2007-05-04 05:29:25	00:00:27					
2007-05-04 05:28:58	2007-05-04 05:29:25	00:00:27					
2007-05-04 05:28:59	2007-05-04 05:29:26	00:00:27					

Filename	Start Time	End Time	Duration	Size	Codec
2460720070503202842...	2007-05-04 05:28:42	2007-05-04 05:29:09	00:00:27	146 KB	
2460720070503202842...	2007-05-04 05:28:42	2007-05-04 05:29:09	00:00:27	174 KB	

Smart File Manager

(Server to Local Backup)

The screenshot displays the Smart File Manager application window. The main interface shows a tree view on the left with 'Remote Database (172.17.101.251)' and 'Local Database (127.0.0.1)'. A 'Download' dialog box is open, showing a list of files being downloaded from the remote database to the local backup directory 'E:\Wbackup'. The dialog includes a progress bar and a status message: 'File: callrecfiles/20070504/2460220070503202840-223541-5012-S downloading.. (41/1996)'. The status bar at the bottom shows the current date and time as '2007-05-04 오후 9:40:36', the version as '1.0.2651', and the next backup time as '2007-05-06 오전 3:00:00'.

File Name	Duration	Size	Date Time	Status
✓ callrecfiles/20070504/2460120070...	00:00:27	147 KB	2007-05-04 05:2...	Done
✓ callrecfiles/20070504/2460120070...	00:00:27	178 KB	2007-05-04 05:2...	Done
✓ callrecfiles/20070504/2461320070...	00:00:27	147 KB	2007-05-04 05:2...	Done
✓ callrecfiles/20070504/2461320070...	00:00:27	174 KB	2007-05-04 05:2...	Done
✓ callrecfiles/20070504/2462320070...	00:00:27	147 KB	2007-05-04 05:2...	Done
✓ callrecfiles/20070504/2462320070...	00:00:27	178 KB	2007-05-04 05:2...	Done
✓ callrecfiles/20070504/2462620070...	00:00:27	146 KB	2007-05-04 05:2...	Done
✓ callrecfiles/20070504/2462620070...	00:00:27	176 KB	2007-05-04 05:2...	Done
✓ callrecfiles/20070504/2464120070...	00:00:27	144 KB	2007-05-04 05:2...	Done
✓ callrecfiles/20070504/2464120070...	00:00:27	176 KB	2007-05-04 05:2...	Done
✓ callrecfiles/20070504/2464320070...	00:00:27	146 KB	2007-05-04 05:2...	Done

Smart NMS

Smart Network Management System

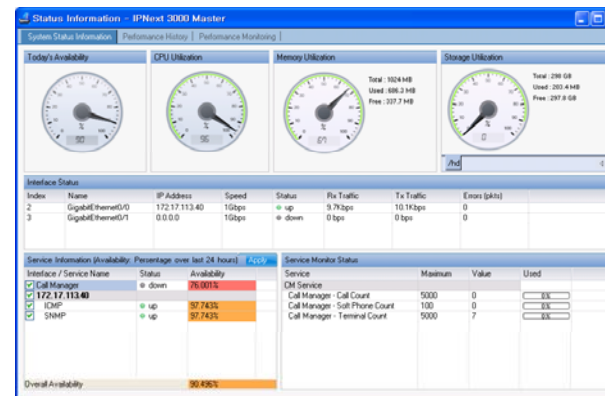
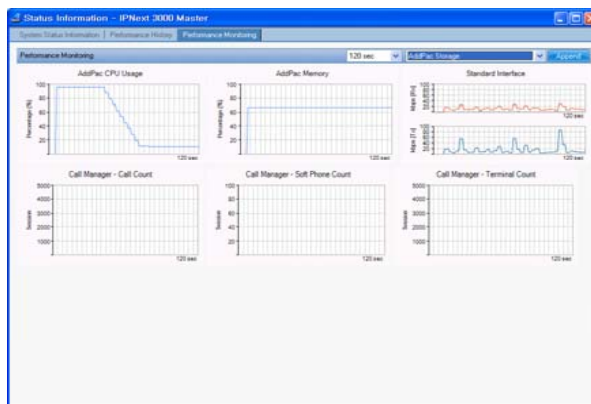

Contents

- System Requirement
- Smart NMS Networking Diagram
- Web-based Management
- Network Resource Management
- Device Fault Management
- Device Fault History Management
- Device Status Information
- Notification Management
- Fault Statistics
- Model & Service Management

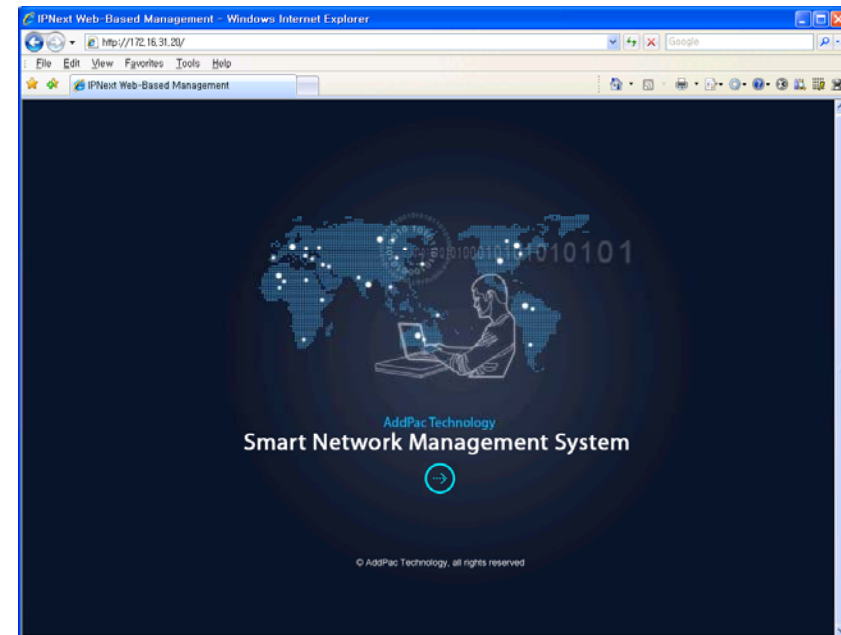

System Requirement

NMS Server

- OS : RHEL (Redhat Enterprise Linux) 5.0 or higher
- CPU : Quad-Core 2.0 GHz / 1333MHz FSB 2x4 MB cache
- Physical Memory : 4 GB
- HDD : 300 G
- JRE (Java Runtime Environment) 1.5.1 or Higher
- Database : PostgreSQL 8.1.11

NMS Client

- Windows XP, Vista, Windows Server 2000/2003
- Microsoft Internet Explorer 6.0 or higher

NMS Networking Diagram

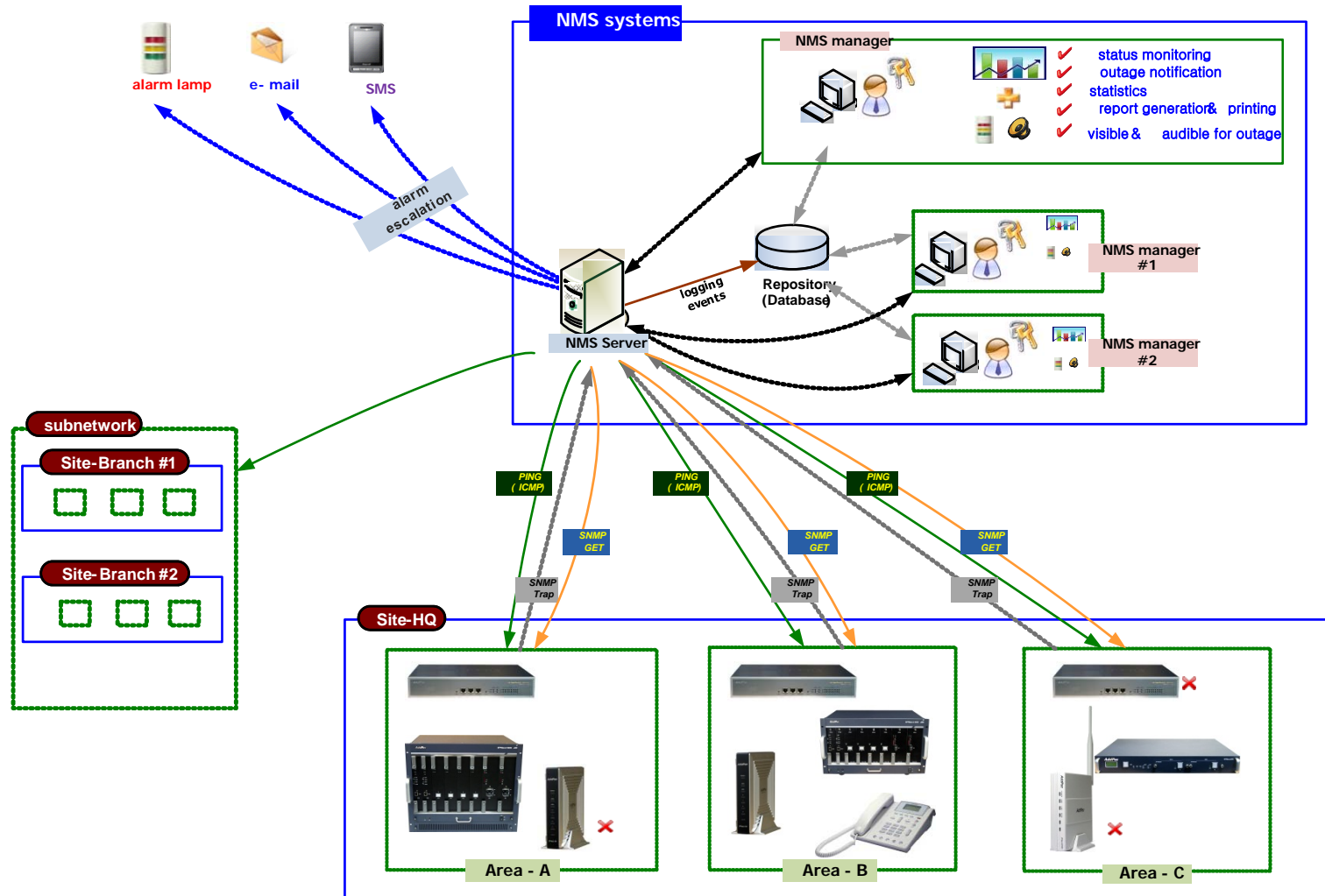

Web-based Management

- **Easy Access via Web browser**
 - Microsoft Internet Explorer 6.0 or higher compatible
- **Version Control**
 - Automatic version check
 - New version software download feature
- **UI control**
 - User friendly GUI management

Version Control

The screenshot displays the IPNext Web-Based Management interface within a Windows Internet Explorer browser window. The browser's address bar shows the URL `http://172.16.31.20/`. The main content area features a dark blue background with a world map and a person using a laptop, with the text "AddPac Technology Smart Network Management System" and a copyright notice "© AddPac Technology, all rights reserved".

Two callout boxes highlight specific features:

- Automatic version check:** A yellow box with an arrow pointing to the top of the main interface.
- New S/W version update:** A yellow box with an arrow pointing to the bottom of the main interface.

Two Windows dialog boxes are overlaid on the interface:

- Launching Application:** A dialog box with a blue title bar and a close button. It contains a progress bar and the text "Verifying application requirements. This may take a few moments." Below the progress bar are icons of a computer and a globe.
- (61%) Downloading installnms:** A dialog box with a blue title bar and standard window controls. It contains the text "Downloading installnms" and "This may take several minutes. You can use your computer to do other tasks during the installation." Below this is a progress bar showing 61% completion. The details include: "Name: installnms", "From: 172.16.31.20", and "Downloading: 6.29 MB of 10.1 MB". A "Cancel" button is at the bottom right.

Web-based Login

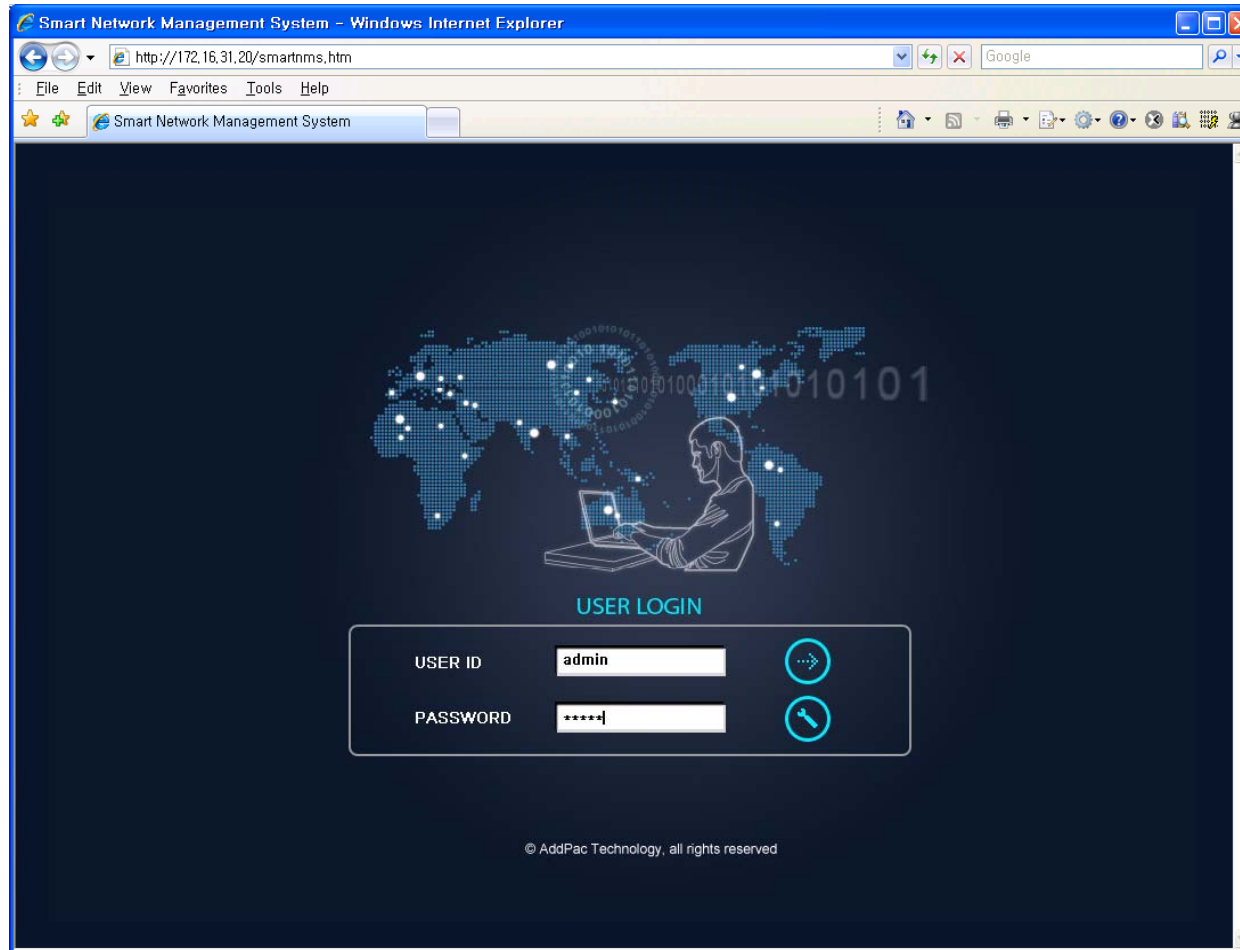

Network Resource Management

- Network resource management with hierarchical structure
- Role-based resource management for each administrator

The screenshot displays the AddPac Network Resource Management interface. On the left, a hierarchical tree view shows the network structure, including sites like AddPac, Seoul, and various branches. The main area shows a table of categories with columns for Category Name and Description. A context menu is open over the tree, highlighting 'Execute SMM'. A 'User Properties' dialog box is also visible, showing a selection of sites for a user.

Category Name	Description
Desktop	PC, notebook, laptop, etc
Network Camera	Network Camera Category
Phone	IP Phone, Video Phone
Server	PBX, RBT, UMS, Presence
Switch	Network Switch
VoIP Gateway	AddPac Digital(or Analog) Gateway

manage the complex network with a structured, hierarchical form

can assign the hierarchical node to the operator and manage role-based policy

can cooperate with the application executables such as SMM

Device Fault Management

- Centralized fault summary information in main window
- Display current fault device through tree view
- Notify administrator with detailed fault information
- Provide device availability information for 24hrs

Device Fault Management

main window

current device fault list with hierarchy view

current device fault event message are shown as below

site device fault summary

overall total device fault statistics

device fault summary for category (classification)

Site	Type	Outages	Availability	Description
AddPac	Sub Netw...	28 / 10 / 32	59%	AddPac Technology C...
Seoul	Sub Netw...	2 / 1 / 2	98%	Seoul subnetwork
Overall Availability		30 / 11 / 34	78.650 %	

Category	Outages	Availability
Desktop	0 / 0 / 1	100%
Network Camera	6 / 1 / 2	54%
Phone	0 / 0 / 3	98%
Server	24 / 10 / 22	58%
Switch	0 / 0 / 0	100%
VoIP Gateway	0 / 0 / 6	98%
Overall Categories Availability	30 / 11 / 34	61.282 %

Ack	ID	Send Time	Site	Device Name	IP Address	Service	Message
<input type="checkbox"/>	9502	4/10/2009 3:34:29 PM	/Subnetwork #2/Center	NMS_SOHO_PBX			device NMS_SOHO_PBX, all services are down
<input type="checkbox"/>	9495	4/10/2009 11:37:12 AM	/AddPac/Branch GX	IPNext 3000 Slave	172.17.113.41	Call Manager	interface 172.17.113.41 (172.17.113.41) device (IPNext 3000 Slave) service Call Manager 2009-4-10 11:37:12 failed.
<input type="checkbox"/>	9494	4/10/2009 11:37:12 AM	/AddPac/Branch GX	IPNext 3000 Master	172.17.113.40	Call Manager	interface 172.17.113.40 (172.17.113.40) device (IPNext 3000 Master) service Call Manager 2009-4-10 11:37:12 failed.
<input type="checkbox"/>	9418	4/9/2009 2:20:01 PM	/AddPac/Branch GX	00_IVR_server			device 00_IVR_server all services are down.
<input type="checkbox"/>	9396	4/9/2009 10:57:37 AM	/AddPac/Branch AQ	NMS_IP_PBX_31.13			device NMS_IP_PBX_31.13 all services down.
<input type="checkbox"/>	9239	4/6/2009 7:49:20 PM	/AddPac/Branch AQ	NMS Camera 2	172.16.253.118		device (NMS Camera 2) interface 172.16.253.118 (172.16.253.118) not response or deleted by administrator
<input type="checkbox"/>	9238	4/6/2009 7:49:20 PM	/AddPac/Branch AQ	NMS Camera 2	172.16.253.118	ICMP	device (NMS Camera 2) interface 172.16.253.118 (172.16.253.118) service ICMP not response or deleted by administrator
<input type="checkbox"/>	9237	4/6/2009 7:49:20 PM	/AddPac/Branch AQ	NMS Camera 2	172.16.253.118	SNMP	device (NMS Camera 2) interface 172.16.253.118 (172.16.253.118) service SNMP not response or deleted by administrator
<input type="checkbox"/>	9236	4/6/2009 7:41:25 PM	/AddPac/Branch AQ	NMS Camera 2	172.16.253.118	ICMP	device(NMS Camera 2) interface 172.16.253.118 (172.16.253.118) service ICMP not response or deleted by administrator
<input type="checkbox"/>	9235	4/6/2009 7:41:25 PM	/AddPac/Branch AQ	NMS Camera 2	172.16.253.118	SNMP	device(NMS Camera 2) interface 172.16.253.118 (172.16.253.118) service SNMP not response or deleted by administrator

Device Fault Management

Smart Network Management System - Windows Internet Explorer

http://172.16.31.20/smarnms.htm

NMS Account Configuration Monitoring Notification Fault Statistics View Help

Current Outage Devices (12)

Name	Service...	Availability
Branch AQ		
NMS Camera	6 of 12	48.994 %
NMS_IP_PBX...	3 of 3	0.000 %
Branch GX		
00_IVR_server	3 of 3	0.000 %
00_IVR_slave...	3 of 3	0.000 %
00_NR_server	1 of 2	98.015 %
00_PS_server	3 of 3	0.000 %
00_PS_Slave...	2 of 3	32.703 %
IPNext 3000 ...	1 of 3	90.536 %
IPNext 3000 S...	1 of 3	90.584 %
UMS slave	3 of 3	0.000 %
HeadQuarter		
UMS server(o...	3 of 3	0.000 %
Subnetwork #2		
NMS_SOHO_...	2 of 2	92.939 %

Service Outages Device Monitoring - <All>

Group Type Value View Mode Refresh Import

display message icon when the device have a notification for event

device status matrix with several severity such as critical, major, minor

- * severity color
- 1) red : critical
- 2) orange : major
- 3) light blue : normal

Total Monitoring Devices : 34

ACK ID	Send Time	Site	Device Name	IP Address	Service	Message
9525	4/10/2009 5:21:06 PM	/AddPac/Branch GX	00_IVR_server	172.17.111.21	SNMP	인터페이스 172.17.111.21 (172.17.111.21)의 장비명(00_IVR_server)의 서비스 SNMP가 2009년 4월 10일 금요일 오후 5시 21분 06초에 실패함.
9502	4/10/2009 3:34:29 PM	/Subnetwork #2/Center	NMS_SOHO_PBX			device NMS_SOHO_PBX, all services are down
9495	4/10/2009 11:37:12 AM	/AddPac/Branch GX	IPNext 3000 Slave	172.17.113.41	Call Manager	interface 172.17.113.41 (172.17.113.41) device (IPNext 3000 Slave) service Call Manager 2009-4-10 11:37:12 failed.
9494	4/10/2009 11:37:12 AM	/AddPac/Branch GX	IPNext 3000 Master	172.17.113.40	Call Manager	interface 172.17.113.40 (172.17.113.40) device (IPNext 3000 Master) service Call Manager 2009-4-10 11:37:12 failed.
9418	4/9/2009 2:20:01 PM	/AddPac/Branch GX	00_IVR_server			device 00_IVR_server all services are down.

Your Outstanding Notices (17)

4/10/2009 5:16:30 PM 172.16.31.20:5101 admin Version 1.2.3384

Device Fault Management

The screenshot displays the Smart NMS interface within a Windows Internet Explorer browser window. The main content area shows a 'Device Monitoring' view with a grid of device status icons. A red box highlights this grid, with a red arrow pointing to it and the text 'device status matrix with small view mode'. The grid contains various device icons, some with red 'X' marks indicating faults. Below the grid, a table lists 'Your Outstanding Notices (18)'. The table has columns for Ack, ID, Send Time, Site, Device Name, IP Address, Service, and Message. The bottom status bar shows the date and time as 4/13/2009 3:14:58 PM, the IP address 172.16.31.20:5101, the user admin, and the version 1.2.3384.

Ack	ID	Send Time	Site	Device Name	IP Address	Service	Message
<input type="checkbox"/>	9535	4/10/2009 9:26:04 PM	/AddPac/Branch GX	00_RBT_server			device 00_RBT_server's all services are down.
<input type="checkbox"/>	9527	4/10/2009 5:34:10 PM	/AddPac/HeadQuarter	5th floor meeting...			device 5th floor meeting room phone device, all services are down.
<input type="checkbox"/>	9502	4/10/2009 3:34:29 PM	/Subnetwork #2/Cent...	NMS_SOHO_PBX			device NMS_SOHO_PBX, all services are down
<input type="checkbox"/>	9495	4/10/2009 11:37:12 AM	/AddPac/Branch GX	IPNext 3000 Slave	172.17.113.41	Call Manager	Call Manager 2009-4-10 11:37:12 failed
<input type="checkbox"/>	9494	4/10/2009 11:37:12 AM	/AddPac/Branch GX	IPNext 3000 Master	172.17.113.40	Call Manager	interface 172.17.113.40 (172.17.113.40) device (IPNext 3000 Master) service Call Manager 2009-4-10 11:37:12 failed
<input type="checkbox"/>	9418	4/9/2009 2:20:01 PM	/AddPac/Branch GX	00_IVR_server			device 00_IVR_server all services are down.
<input type="checkbox"/>	9396	4/9/2009 10:57:37 AM	/AddPac/Branch AQ	NMS_IP_PBX_3...			device NMS_IP_PBX_31.13 all services down.
<input type="checkbox"/>	9229	4/6/2009 7:49:20 PM	/AddPac/Branch AQ	NMS Camera 2	172.16.253.110		device (NMS Camera 2) interface 172.16.253.118 (172.16.253.118) not response or delete by administrator
<input type="checkbox"/>	9238	4/6/2009 7:49:20 PM	/AddPac/Branch AQ	NMS Camera 2	172.16.253.118	ICMP	device (NMS Camera 2) interface 172.16.253.118 (172.16.253.118) service ICMP not response or deleted by administrator

Device Fault History Management

- Provide both summary view and detailed event message
- Can Write troubleshooting job note for each event manually
- Administrator can query for a history fault with search condition
- Each fault is related to the several raw events

Device Fault History Management

daily fault event summary statistics information

detail fault event history list up with filter condition (advanced search)

The screenshot displays the Smart Network Management System (NMS) interface within a Windows Internet Explorer browser. The main window shows a 'Notification Summary' table on the left and a detailed fault event history table on the right. An 'Advanced Search' dialog box is open, allowing users to filter fault events based on various criteria.

Notification Summary Table:

Date/Time	Outstanding	Acknowledge
2009-04-10	4	27
2009-04-09	2	76
2009-04-08	0	96
2009-04-07	0	40
2009-04-06	7	489
2009-04-05	0	722
2009-04-04	0	708
2009-04-03	1	476
2009-04-02	0	248
2009-04-01	0	19
2009-03-31	0	37
2009-03-30	0	9
2009-03-29	0	3
2009-03-28	0	1
2009-03-27	0	14
2009-03-26	0	52
2009-03-25	0	8
2009-03-24	0	19
2009-03-23	0	59
2009-03-22	0	102
2009-03-21	0	17
2009-03-20	0	21
2009-03-18	0	48
2009-03-17	0	41
2009-03-13	0	36
2009-03-07	0	1
2009-03-06	0	482
2009-03-05	0	38
2009-03-04	0	13

Advanced Search Dialog:

- Sub Network: <All>
- Site: <All>
- IP Address Contains: []
- Notice Status Type: <All>
- Message Contains: []
- Level (Severity): <All>
- Notices After: 11/10/2008 17:20:49
- Notices Before: 11/10/2008 17:20:49
- Sort By: ID, Descending

Main Fault Event History Table (Partial):

Ack	ID	Send Time	Site	Device Name	IP Address	Service	Message	Response	Respond Time
<input type="checkbox"/>	9528	4/10/2009 5:51:06 PM	/AddPac/Branch AQ	NMS Camera	172.16.4.180	SNMP	interface 172.16.4.180 (172.16.4.180) device(NMS Camera) service SNMP failed at 2009-4-10 5:51:06 PM	auto-acknowledged	4/10/2009 5:51:35 PM
<input type="checkbox"/>	9527	4/10/2009 5:34:10 PM	/AddPac/HeadQuarter	5th floor meeting room phone device			device 5th floor meeting room phone device, all services are down.	auto-acknowledged	4/10/2009 5:35:25 PM
<input type="checkbox"/>	9526	4/10/2009 5:33:42 PM	/AddPac/Branch GX	00_NR_server	172.17.11.1			auto-acknowledged	4/10/2009 5:22:43 PM
<input type="checkbox"/>	9525	4/10/2009 5:21:06 PM	/AddPac/Branch GX	00_NR_server	172.17.11.1			auto-acknowledged	4/10/2009 5:17:56 PM
<input type="checkbox"/>	9524	4/10/2009 5:17:29 PM	/AddPac/Branch GX	00_NR_server	172.17.11.1			auto-acknowledged	4/10/2009 4:03:13 PM
<input type="checkbox"/>	9522	4/10/2009 3:36:26 PM	/AddPac/HeadQuarter	IP_PBX_Slave(our company)				auto-acknowledged	4/10/2009 4:03:13 PM
<input type="checkbox"/>	9521	4/10/2009 3:36:18 PM	/AddPac/HeadQuarter	PS server(our co...				auto-acknowledged	4/10/2009 4:03:13 PM
<input type="checkbox"/>	9520	4/10/2009 3:36:17 PM	/AddPac/HeadQuarter	RBT server(our company)				auto-acknowledged	4/10/2009 4:03:13 PM
<input type="checkbox"/>	9519	4/10/2009 3:36:17 PM	/AddPac/HeadQuarter	UMS server #2				auto-acknowledged	4/10/2009 4:03:13 PM
<input type="checkbox"/>	9518	4/10/2009 3:36:09 PM	/AddPac/HeadQuarter	Recording Server (our company)				auto-acknowledged	4/10/2009 4:03:14 PM
<input type="checkbox"/>	9517	4/10/2009 3:36:08 PM	/AddPac/HeadQuarter	company_MCU_s...				auto-acknowledged	4/10/2009 4:03:13 PM
<input type="checkbox"/>	9516	4/10/2009 3:36:00 PM	/AddPac/Branch GX	00_PS_Slave_ser...				auto-acknowledged	4/10/2009 4:02:54 PM
<input type="checkbox"/>	9514	4/10/2009 3:35:50 PM	/AddPac/Branch GX	00_PS_server				auto-acknowledged	4/10/2009 4:02:43 PM
<input type="checkbox"/>	9513	4/10/2009 3:35:41 PM	/AddPac/HeadQuarter	5th floor meeting room phone device				auto-acknowledged	4/10/2009 4:02:44 PM
<input type="checkbox"/>	9512	4/10/2009 3:35:41 PM	/AddPac/HeadQuarter	IP_PBX_Master (our company)				auto-acknowledged	4/10/2009 4:02:43 PM
<input type="checkbox"/>	9511	4/10/2009 3:35:33 PM	/AddPac/Branch KT	172.16.51.12				auto-acknowledged	4/10/2009 4:02:43 PM

Your Outstanding Notices (17) Table:

Ack	ID	Send Time	Site	Device Name	IP Address	Service	Message
<input type="checkbox"/>	9527	4/10/2009 5:34:10 PM	/AddPac/HeadQuarter	5th floor meeting ro...			device 5th floor meeting room phone device, all services are down.
<input type="checkbox"/>	9502	4/10/2009 3:34:29 PM	/Subnetwork #2/Center	NMS_S0HD_PBX			device NMS_S0HD_PBX, all services are down.
<input type="checkbox"/>	9495	4/10/2009 11:37:12 AM	/AddPac/Branch GX	IPNext 3000 Slave	172.17.113.41	Call Manager	interface 172.17.113.41 (172.17.113.41) device (IPNext 3000 Slave) service Call Manager 2009-4-10 11:37:12 failed.
<input type="checkbox"/>	9494	4/10/2009 11:37:12 AM	/AddPac/Branch GX	IPNext 3000 Master	172.17.113.40	Call Manager	interface 172.17.113.40 (172.17.113.40) device (IPNext 3000 Master) service Call Manager 2009-4-10 11:37:12 failed.
<input type="checkbox"/>	9418	4/9/2009 2:20:01 PM	/AddPac/Branch GX	00_IVR_server			device 00_IVR_server all services are down.
<input type="checkbox"/>	9386	4/9/2009 10:57:37 AM	/AddPac/Branch AQ	NMS_IP_PBX_31.13			device NMS_IP_PBX_31.13 all services down.
<input type="checkbox"/>	9239	4/6/2009 7:49:20 PM	/AddPac/Branch AQ	NMS Camera 2	172.16.253.118		device (NMS Camera 2) interface 172.16.253.118 (172.16.253.118) not response or delete by administrator.
<input type="checkbox"/>	9238	4/6/2009 7:49:20 PM	/AddPac/Branch AQ	NMS Camera 2	172.16.253.118	ICMP	device (NMS Camera 2) interface 172.16.253.118 (172.16.253.118) service ICMP not response or deleted by administrator.
<input type="checkbox"/>	9237	4/6/2009 7:49:20 PM	/AddPac/Branch AQ	NMS Camera 2	172.16.253.118	SNMP	device (NMS Camera 2) interface 172.16.253.118 (172.16.253.118) service SNMP not response or deleted by administrator.

Device Fault History Management

The screenshot displays the Smart Network Management System (NMS) interface. The main window shows a table of device fault history with columns: Date/Time, Outstanding, Acknowledge, ID, Send Time, Site, Device Name, IP Address, Service, Message, Responder, and Respond Time. Two pop-up windows are visible: 'Troubleshooting Note (Event ID : 45393)' and 'Troubleshooting Note'. An orange callout box points to the 'Troubleshooting Note' window with the text 'Can write troubleshooting note if needed'.

Date/Time	Outstanding	Acknowledge	ID	Send Time	Site	Device Name	IP Address	Service	Message	Responder	Respond Time
2009-04-10	4	27	9528	4/10/2009 5:51:06 PM	/AddPac/Branch AQ	NMS Camera	172.16.4.180	SNMP	interface 172.16.4.180 (172.16.4.180) device(NMS Camera) service SNMP failed at 2009-4-10 5:51:06 PM	auto-acknowledged	4/10/2009 5:51:35 PM
2009-04-09	2	76	9527	4/10/2009 5:34:10 PM	/AddPac/HeadQuarter	5th floor meeting room phone device			device 5th floor meeting room phone device, all services are down.	to-acknowledged	4/10/2009 5:35:25 PM
2009-04-08	0	96	9526	4/10/2009 5:33:42 PM	/AddPac/Branch GX					to-acknowledged	4/10/2009 5:22:43 PM
2009-04-07	0	40	9525	4/10/2009 5:21:06 PM	/AddPac/Branch GX					to-acknowledged	4/10/2009 5:17:56 PM
2009-04-06	7	489	9524	4/10/2009 5:17:29 PM	/AddPac/Branch GX					to-acknowledged	4/10/2009 4:03:13 PM
2009-04-05	0	722	9523	4/10/2009 3:36:26 PM	/AddPac/HeadQuarter	IP cor				to-acknowledged	4/10/2009 4:03:13 PM
2009-04-04	0	708	9522	4/10/2009 3:36:18 PM	/AddPac/HeadQuarter	PB cor				to-acknowledged	4/10/2009 4:03:13 PM
2009-04-03	1	476	9521	4/10/2009 3:36:17 PM	/AddPac/HeadQuarter	UM				to-acknowledged	4/10/2009 4:03:13 PM
2009-04-02	0	248	9520	4/10/2009 3:36:17 PM	/AddPac/HeadQuarter	Re (ou				to-acknowledged	4/10/2009 4:03:13 PM
2009-04-01	0	19	9519	4/10/2009 3:36:17 PM	/AddPac/HeadQuarter	ter				to-acknowledged	4/10/2009 4:03:14 PM
2009-03-31	0	37	9518	4/10/2009 3:36:17 PM	/AddPac/HeadQuarter	00				to-acknowledged	4/10/2009 4:03:13 PM
2009-03-30	0	9	9517	4/10/2009 3:36:17 PM	/AddPac/HeadQuarter	00				to-acknowledged	4/10/2009 4:02:54 PM
2009-03-29	0	3	9516	4/10/2009 3:36:17 PM	/AddPac/HeadQuarter	5th				to-acknowledged	4/10/2009 4:02:43 PM
2009-03-28	0	1	9515	4/10/2009 3:36:17 PM	/AddPac/HeadQuarter	IP (ou				to-acknowledged	4/10/2009 4:02:44 PM
2009-03-27	0	14	9514	4/10/2009 3:36:17 PM	/AddPac/HeadQuarter	00				to-acknowledged	4/10/2009 4:02:43 PM
2009-03-26	0	52	9513	4/10/2009 3:36:17 PM	/AddPac/HeadQuarter	00				to-acknowledged	4/10/2009 4:02:43 PM
2009-03-25	0	8	9512	4/10/2009 3:36:17 PM	/AddPac/HeadQuarter	00				to-acknowledged	4/10/2009 4:02:43 PM
2009-03-24	0	19	9511	4/10/2009 3:36:17 PM	/AddPac/HeadQuarter	00				to-acknowledged	4/10/2009 4:02:43 PM
2009-03-23	0	59	9510	4/10/2009 3:36:17 PM	/AddPac/HeadQuarter	00				to-acknowledged	4/10/2009 4:02:43 PM
2009-03-22	0	102	9509	4/10/2009 3:36:17 PM	/AddPac/HeadQuarter	00				to-acknowledged	4/10/2009 4:02:43 PM
2009-03-21	0	1	9508	4/10/2009 3:36:17 PM	/AddPac/HeadQuarter	00				to-acknowledged	4/10/2009 4:02:43 PM
2009-03-20	0	1	9507	4/10/2009 3:36:17 PM	/AddPac/HeadQuarter	00				to-acknowledged	4/10/2009 4:02:43 PM
2009-03-18	0	1	9506	4/10/2009 3:36:17 PM	/AddPac/HeadQuarter	00				to-acknowledged	4/10/2009 4:02:43 PM
2009-03-17	0	1	9505	4/10/2009 3:36:17 PM	/AddPac/HeadQuarter	00				to-acknowledged	4/10/2009 4:02:43 PM
2009-03-13	0	1	9504	4/10/2009 3:36:17 PM	/AddPac/HeadQuarter	00				to-acknowledged	4/10/2009 4:02:43 PM
2009-03-07	0	1	9503	4/10/2009 3:36:17 PM	/AddPac/HeadQuarter	00				to-acknowledged	4/10/2009 4:02:43 PM
2009-03-06	0	1	9502	4/10/2009 3:36:17 PM	/AddPac/HeadQuarter	00				to-acknowledged	4/10/2009 4:02:43 PM
2009-03-05	0	1	9501	4/10/2009 3:36:17 PM	/AddPac/HeadQuarter	00				to-acknowledged	4/10/2009 4:02:43 PM
2009-03-04	0	1	9500	4/10/2009 3:36:17 PM	/AddPac/HeadQuarter	00				to-acknowledged	4/10/2009 4:02:43 PM

Current Device Fault (Outage)

The screenshot displays the Smart Network Management System (NMS) interface. The main window shows a tree view of network devices on the left and a table of 'Current Outage Devices' on the right. A red box highlights the '00_RBT_server' device in the table, with an annotation: "Display the current all device faults".

An 'Event Detail (ID: 45412)' dialog box is open, showing the following information:

- Event Time: 4/10/2009 9:26:04 PM
- Site: /AddPac/Branch GX
- Device Name: 00_RBT_server
- Service: Media
- Severity: Critical
- Device Model: AP-RBT1000
- Log Message: device 00_RBT_server down
- Description: device 00_RBT_server's all interface down. A new Outage record has been created and service level availability calculations will be impacted until this outage is resolved.

An annotation points to the 'Description' field: "Can view the event data related to the current device fault and can write troubleshooting note if needed". Below the description is a 'Troubleshooting Note List' table with columns for Time, User, Status, and Note.

At the bottom of the interface, there is a section for 'Your Outstanding Notices (18)' with a table of notices including ID, Send Time, Site, Device Name, IP Address, and Service.

Device Event History

Smart Network Management System - Windows Internet Explorer

http://172.16.31.20/smartnms.htm

NMS Account Configuration Monitoring Notification Fault Statistics View Help

Site Event Summary Service Outages Event Notification Destination Paths Users View Current Outages View Outages View Events

Limit: 20 Refresh Advanced Search Acknowledge Events Troubleshooting Note

Event Time	Outlets	Ackno...	Not Clea...	Cleared	In Pr...
2009-04-13	40	0	40	0	0
2009-04-12	6	0	6	0	0
2009-04-11	314	0	314	0	0
2009-04-10	182	0	182	0	0
2009-04-09	290	0	290	0	0
2009-04-08	412	0	412	0	0
2009-04-07	448	0	448	0	0
2009-04-06	1453	0	1453	0	0
2009-04-05	1704	0	1704	0	0
2009-04-04	1712	0	1712	0	0
2009-04-03	1276	0	1276	0	0
2009-04-02	799	0	799	0	0
2009-04-01	271	0	271	0	0
2009-03-31	277	0	277	0	0
2009-03-30	212	0	212	0	0
2009-03-29	17	0	17	0	0
2009-03-28	2	0	2	0	0
2009-03-27	108	0	108	0	0
2009-03-26	292	0	292	0	0
2009-03-25	46	0	46	0	0
2009-03-24	121	0	121	0	0
2009-03-23	1904	0	1904	0	0
2009-03-22	2643	0	2643	0	0
2009-03-21	354	0	354	0	0
2009-03-20	172	0	172	0	0
2009-03-19	1	0	1	0	0
2009-03-18	1294	0	1294	0	0
2009-03-17	788	0	788	0	0
2009-03-16	14	0	14	0	0
2009-03-15	3	0	3	0	0

Ack	ID	Severity	Event Time	Site	Device Name	IP Address	Service	Message
<input type="checkbox"/>	45786	Critical	4/13/2009 11:24:42 AM	/AddPac/Branch GX	SE_MG3000N_A	172.17.111.25		Agent Up with enterprise: 1.3.6.1.4.1.4855.3.2.255 [1.3.6.1.4.1.4855.3.2.255] args [1.3.6.1.6.3.1.1.4.3.0="1.3.6.1.4.1.4855.3.2.255"
<input type="checkbox"/>	45785	Cleared	4/13/2009 11:15:59 AM	/AddPac/Branch GX	00_NR_server	172.17.111.21	SNMP	SNMP data collection on interface 172.17.111.21 previously failed and has been restored.
<input type="checkbox"/>	45784	Cleared	4/13/2009 11:15:52 AM	/AddPac/Branch GX	00_NR_server			Node 00_NR_server is up.
<input type="checkbox"/>	45783	Critical	4/13/2009 11:15:51 AM	/AddPac/Branch GX	00_NR_server	172.17.111.21		Agent Up with Possible Changes (coldStart Trap) enterprise: 1.3.6.1.4.1.4855.3.2.10 [1.3.6.1.4.1.4855.3.2.10] args [1.3.6.1.6.3.1.1.4.3.0="1.3.6.1.4.1.4855.3.2.10"
<input type="checkbox"/>	45782	Critical	4/13/2009 11:15:13 AM	/AddPac/Branch GX	00_NR_server			Node 00_NR_server is down.
<input type="checkbox"/>	45781	Warning	4/13/2009 11:14:57 AM	/AddPac/Branch GX	00_NR_server	172.17.111.21	SNMP	SNMP data collection on interface 172.17.111.21 failed.
<input type="checkbox"/>	45780	Warning	4/13/2009 10:00:15 AM	/AddPac/Branch AQ	NMS_IP_PBX_31...	172.16.31.13	SNMP	SNMP thresholding on interface 172.16.31.13 failed.
<input type="checkbox"/>	45779	Warning	4/13/2009 10:00:15 AM	/Subnetwork #2/Center	NMS_IP_PBX_31...	172.16.31.16	SNMP	SNMP thresholding on interface 172.16.31.16 failed.
<input type="checkbox"/>	45778	Warning	4/13/2009 9:59:51 AM	/AddPac/Branch GX	UMS slave	172.17.113.201	SNMP	SNMP data collection on interface 172.17.113.201 failed.
<input type="checkbox"/>	45777	Warning	4/13/2009 9:59:46 AM	/AddPac/Branch GX	UMS slave	172.17.113.201	SNMP	SNMP data collection on interface 172.17.113.201 failed.
<input type="checkbox"/>	45776	Warning	4/13/2009 9:59:42 AM	/AddPac/HeadQuater	UMS server(our co...	61.33.161.43	SNMP	SNMP data collection on interface 61.33.161.43 failed.
<input type="checkbox"/>	45775	Warning	4/13/2009 9:59:41 AM	/AddPac/HeadQuater	UMS server(our co...	61.33.161.43	SNMP	SNMP data collection on interface 61.33.161.43 failed.
<input type="checkbox"/>	45774	Warning	4/13/2009 9:59:36 AM	/Subnetwork #2/Center	NMS_SDHO_PBX	172.16.19.50	SNMP	SNMP data collection on interface 172.16.19.50 failed.
<input type="checkbox"/>	45773	Warning	4/13/2009 9:59:33 AM	/Subnetwork #2/Center	NMS_SDHO_PBX	172.16.19.50	SNMP	SNMP data collection on interface 172.16.19.50 failed.
<input type="checkbox"/>	45772	Warning	4/13/2009 9:59:32 AM	/Subnetwork #2/Center	NMS_SDHO_PBX	172.16.19.50	SNMP	SNMP data collection on interface 172.16.19.50 failed.
<input type="checkbox"/>	45771	Warning	4/13/2009 9:59:27 AM	/Subnetwork #2/Center	NMS_SDHO_PBX	172.16.19.50	SNMP	SNMP data collection on interface 172.16.19.50 failed.
<input type="checkbox"/>	45770	Warning	4/13/2009 9:59:24 AM	/Subnetwork #2/Center	NMS_SDHO_PBX	172.16.19.50	SNMP	SNMP data collection on interface 172.16.19.50 failed.
<input type="checkbox"/>	45769	Warning	4/13/2009 9:59:23 AM	/Subnetwork #2/Center	NMS_SDHO_PBX	172.16.19.50	SNMP	SNMP data collection on interface 172.16.19.50 failed.
<input type="checkbox"/>	45768	Warning	4/13/2009 9:59:18 AM	/AddPac/Branch AQ	NMS_IP_PBX_31...	172.16.31.13	SNMP	SNMP data collection on interface 172.16.31.13 failed.
<input type="checkbox"/>	45767	Warning	4/13/2009 9:59:15 AM	/AddPac/Branch AQ	NMS_IP_PBX_31...	172.16.31.13	SNMP	SNMP data collection on interface 172.16.31.13 failed.

Results: 1 to 20 of 25346 Search Constraints: user=admin

Site	Device Name	IP Address	Service	Message
/AddPac/Branch GX	00_RBT_server			device 00_RBT_server's all services are down.
/AddPac/HeadQuater	5th floor meeting...			device 5th floor meeting room phone device, all services are down.
/Subnetwork #2/Center	NMS_SDHO_PBX			device NMS_SDHO_PBX, all services are down
/AddPac/Branch GX	IPNext 3000 Slave	172.17.113.41	Call Manager	interface 172.17.113.41 (172.17.113.41) device (IPNext 3000 Slave) service Call Manager 2009-4-10 11:37:12 failed.
/AddPac/Branch GX	IPNext 3000 Master	172.17.113.40	Call Manager	interface 172.17.113.40 (172.17.113.40) device (IPNext 3000 Master) service Call Manager 2009-4-10 11:37:12 failed.
/AddPac/Branch GX	00_IVR_server			device 00_IVR_server all services are down.
/AddPac/Branch AQ	NMS_IP_PBX_3...			device NMS_IP_PBX_31.13 all services down.
/AddPac/Branch AQ	NMS Camera 2	172.16.253.118		device (NMS Camera 2) interface 172.16.253.118 (172.16.253.118) not response or delete by administrator

Your Outstanding Notices (18) All Outstanding Notices (18)

4/13/2009 11:46:45 AM 172.16.31.20:5101 admin Version 1.2.3384

Can view all events for devices with search condition

summarize daily event statistics data

Device Status Information

- System Performance Information (CPU, HDD, Memory,...)
- Provide device current service status (up/down)
- Provide device main status (max value vs current value)
- Display Graph Series with System Performance Information
- Monitor Main Status Flow with System Monitoring View

Device Status Information

Status Information - IPNext 3000 Master

System Status Information | Performance History | Performance Monitoring

Today's Availability

90

CPU Utilization

96

Memory Utilization

67

Total : 1024 MB
Used : 686.3 MB
Free : 337.7 MB

Storage Utilization

0

Total : 298 GB
Used : 203.4 MB
Free : 297.8 GB

/hd

Interface Status

Index	Name	IP Address	Speed	Status	Rx Traffic	Tx Traffic	Errors (pkts)
2	GigabitEthernet0/0	172.17.113.40	1Gbps	● up	9.7Kbps	10.1Kbps	0
3	GigabitEthernet0/1	0.0.0.0	1Gbps	● down	0 bps	0 bps	0

Service Information (Availability: Percentage over last 24 hours) [Apply](#)

Interface / Service Name	Status	Availability
✓ Call Manager	● down	76.001%
✓ 172.17.113.40		
✓ ICMP	● up	97.743%
✓ SNMP	● up	97.743%
Overall Availability		90.496%

Service Monitor Status

Service	Maximum	Value	Used
CM Service			
Call Manager - Call Count	5000	0	0%
Call Manager - Soft Phone Count	100	0	0%
Call Manager - Terminal Count	5000	7	0%

Device Status Information

performance analysis graph for last 24 hours

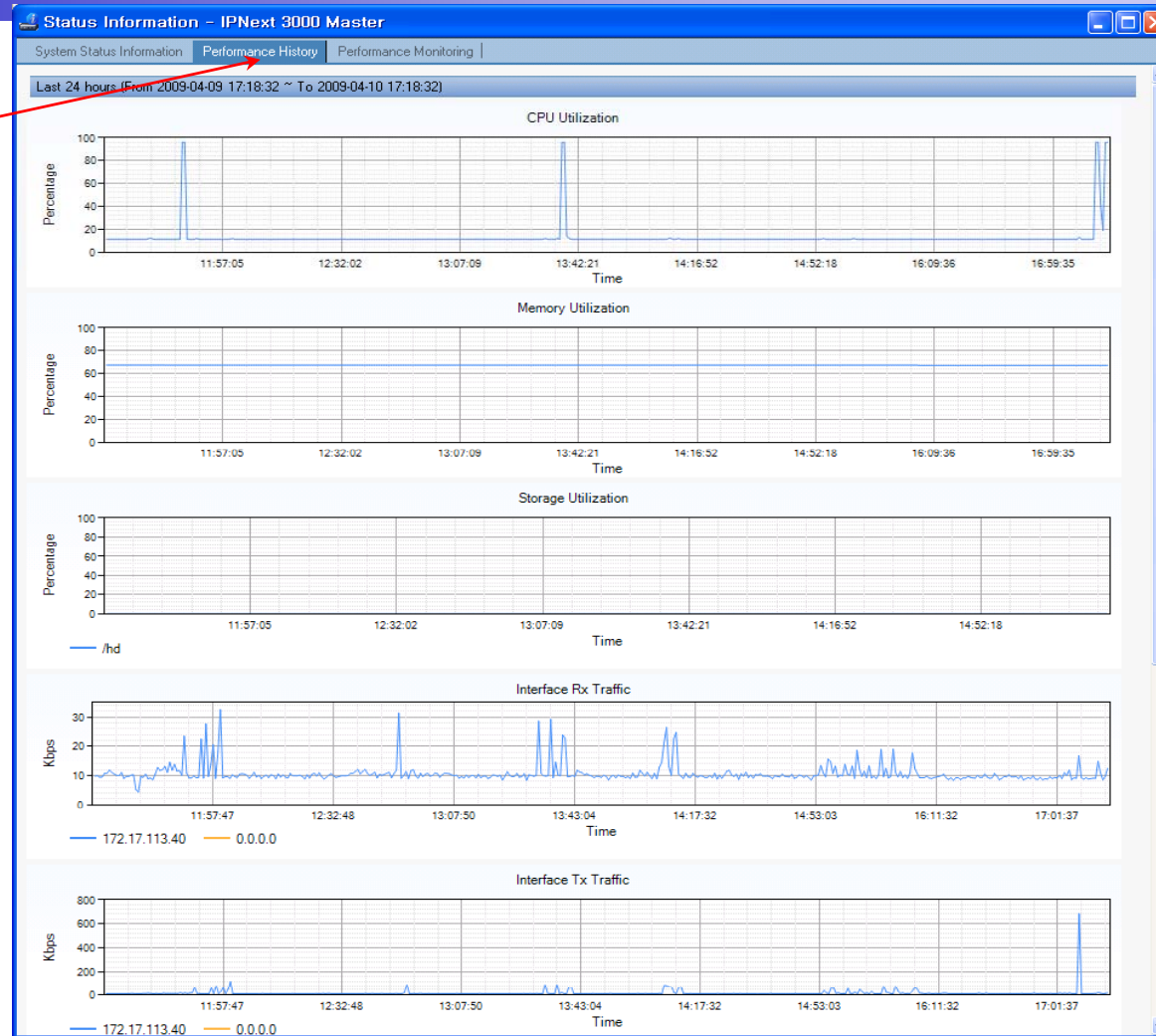

Device Status Information

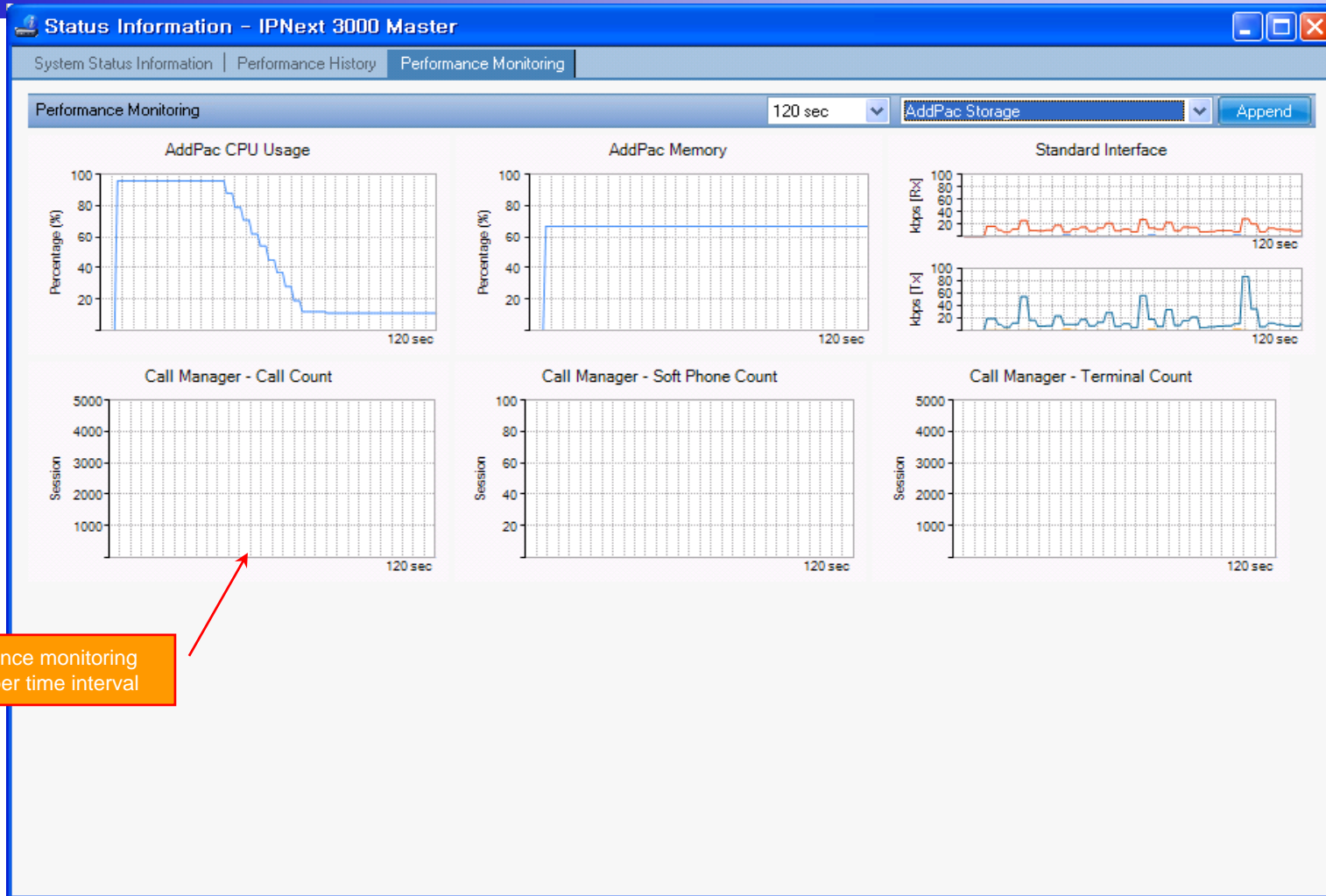

Notification Management

- Notify administrator for important event such as critical device fault when proper action needs
- Provide several notification channel such as SMS, e-mail, alarm lamp
- Notification channel configuration for each event
- Manage notification with device category such as Server, Terminal, PC, etc
- Provide Alarm with audible (play sound), visible (alarm lamp) form

Event Notification Management

The screenshot displays the Smart Network Management System (NMS) interface. The main window shows a tree view of devices under 'AddPac', including 'Branch AQ', 'Branch GX', and 'HeadQuarter'. A table lists various events and their notification paths. An 'Event Notification Properties' dialog box is open, showing configuration for a 'serviceUnresponsive' event. The dialog includes fields for Notification Name, Description, Event, Destination Path, Notification Type, Current Rule, Apply Category, Email Subject, and Text Message. A 'Your Outstanding Notices' table is visible at the bottom, listing recent notifications with columns for Ack, ID, Send Time, Site, Device Name, IP Address, Service, and Message.

apply notification policy with event-based filter
(example : notify me when network link of device is down through SMS, e-mail)

specify category when each event occurs

describe notification message content for e-mail or SMS

Notification Name	Event	Destination Path	Description
serviceUnresponsive	Node event: serviceUnresponsive	NMS Admin	test
serviceResponsive	Node event: serviceResponsive	NMS Admin	
interfaceDown	Node event: interfaceDown	NMS Admin	
nodeDown	Node event: nodeDown	NMS Admin	
interfaceUp	Node event: interfaceUp	NMS Admin	
nodeUp	Node event: nodeUp	NMS Admin	
nodeLostService	Node event: nodeLostService	NMS Admin	
nodeRegainedService	Node event: nodeRegainedService	NMS Admin	
coldStart	SNMP Cold Start	NMS Admin	
warmStart	SNMP Trap: SNMP Warm Start	NMS Admin	
authenticationFailure	SNMP Trap: SNMP Authn Failure	NMS Admin	
serviceDeleted	Node event: serviceDeleted	NMS Admin	
nodeAdded	Node event: nodeAdded	NMS Admin	
nodeInfoChanged	Node event: nodeInfoChanged	NMS Admin	
interfaceDeleted	Node event: interfaceDeleted	NMS Admin	
High Threshold	highThresholdExceeded	NMS Admin	
Low Threshold	lowThresholdExceeded	NMS Admin	
Low Threshold Rearmed	lowThresholdRearmed	NMS Admin	
High Threshold Rearmed	highThresholdRearmed	NMS Admin	

Ack	ID	Send Time	Site	Device Name	IP Address	Service	Message
	9535	4/10/2009 9:26:04 PM	/AddPac/Branch GX	00_RBT_server		device.00_RBT_server.all-services	
	9527	4/10/2009 5:34:10 PM	/AddPac/HeadQuarter	5th_floor_meeting...			
	9502	4/10/2009 3:34:29 PM	/Subnetwork #2/Cent...	NMS_SOHO_PBX			
	9495	4/10/2009 11:37:12 AM	/AddPac/Branch GX	IPNext 3000 Slave	172.17.113.41	Call Manager	
	9494	4/10/2009 11:37:12 AM	/AddPac/Branch GX	IPNext 3000 Master	172.17.113.40	Call Manager	
	9418	4/9/2009 2:20:01 PM	/AddPac/Branch GX	00_IVR_server			
	9396	4/9/2009 10:57:37 AM	/AddPac/Branch AQ	NMS_IP_PBX_3...			
	9239	4/6/2009 7:49:20 PM	/AddPac/Branch AQ	NMS Camera 2	172.16.253.118		

Event Notification Management

The screenshot displays the Smart Network Management System (NMS) interface. A 'Destination Path Properties' dialog box is open, showing configuration options for event notifications. The dialog includes a 'Destination Path Name' field set to 'default', an 'Initial Target' dropdown set to '0m', and a table for defining notification channels. A red callout box points to the 'email' row in this table with the text: 'define notification channel such as e-mail, sms, or alarmlamp'.

Notification Type	Target	Auto Notify
alarmLamp	alarmLamp	on
email	admin	on
sms	admin	on

Below the dialog, the 'Your Outstanding Notices (18)' table is visible, showing a list of events with columns for Ack, ID, Send Time, Site, Device Name, IP Address, Service, and Message.

Ack	ID	Send Time	Site	Device Name	IP Address	Service	Message
<input type="checkbox"/>	9535	4/10/2009 9:26:04 PM	/AddPac/Branch GX	00_RBT_server			device 00_RBT_server's all services are down.
<input type="checkbox"/>	9527	4/10/2009 5:34:10 PM	/AddPac/HeadQuarter	5th floor meeti...			device 5th floor meeting room phone device, all services are down.
<input type="checkbox"/>	9502	4/10/2009 3:34:29 PM	/Subnetwork #2/Cent...	NMS_SDHD_PBX			device NMS_SDHD_PBX, all services are down
<input type="checkbox"/>	9495	4/10/2009 11:37:12 AM	/AddPac/Branch GX	IPNext 3000 Slave	172.17.113.41	Call Manager	interface 172.17.113.41 (172.17.113.41) device (IPNext 3000 Slave) service Call Manager 2009-4-10 11:37:12 failed
<input type="checkbox"/>	9494	4/10/2009 11:37:12 AM	/AddPac/Branch GX	IPNext 3000 Master	172.17.113.40	Call Manager	interface 172.17.113.40 (172.17.113.40) device (IPNext 3000 Master) service Call Manager 2009-4-10 11:37:12 failed
<input type="checkbox"/>	9418	4/9/2009 2:20:01 PM	/AddPac/Branch GX	00_IVR_server			device 00_IVR_server all services are down.
<input type="checkbox"/>	9396	4/9/2009 10:57:37 AM	/AddPac/Branch AQ	NMS_IP_PBX_3...			device NMS_IP_PBX_31.13 all services down.
<input type="checkbox"/>	9229	4/6/2009 7:49:20 PM	/AddPac/Branch AQ	NMS Camera 2	172.16.253.119		device (NMS_Camera 2) interface 172.16.253.118 (172.16.253.118) not response or delete by administrator

Event Notification Management

The screenshot displays the Smart Network Management System (NMS) interface. The main window shows a tree view of network devices and their availability. Two dialog boxes are open for configuration:

- Destination Path Properties:** Shows the destination path name as 'default' and 'onlyAlarmLamp'. It includes a table for notification types and targets:

Notification Type	Target	Auto Notify
alarmLamp	alarmLamp	on
email	admin	on
sms	admin	on
- Target Properties:** Shows the notification type set to 'sms' and the target set to 'alarmLamp'. The 'Send to select user' option is selected, with 'Account Administrator' chosen from the dropdown. The 'Send to Email or Mobile' option is unselected.

A red box highlights the 'Initial Target' field in the Destination Path Properties dialog, which is set to 'Account Administrator'. A red arrow points to the 'Target Properties' dialog, which shows the notification type set to 'sms' and the target set to 'alarmLamp'.

user account (administrator) setting for SMS, E-mail Notification or specify e-mail address or SMS phone number

Your Outstanding Notices (18)

Ack	ID	Send Time	Site	Device Name	IP Address	Message
<input type="checkbox"/>	9535	4/10/2009 9:26:04 PM	/AddPac/Branch Gx	00_RBT_server		device 00_RBT_server's all services are down.
<input type="checkbox"/>	9527	4/10/2009 5:34:10 PM	/AddPac/HeadQuarter	5th floor meeti...		device 5th floor meeting room phone device_all services are down.
<input type="checkbox"/>	9502	4/10/2009 3:34:29 PM	/Subnetwork #2/Cent...	NMS_SOHO_PBX		device NMS_SOHO_PBX: all services are down
<input type="checkbox"/>	9495	4/10/2009 11:37:12 AM	/AddPac/Branch Gx	IPNext 3000 Slave	172.17.113.41	interface 172.17.113.41 (172.17.113.41) device (IPNext 3000 Slave) service Call Manager 2009-4-10 11:37:12 failed.
<input type="checkbox"/>	9494	4/10/2009 11:37:12 AM	/AddPac/Branch Gx	IPNext 3000 Master	172.17.113.40	interface 172.17.113.40 (172.17.113.40) device (IPNext 3000 Master) service Call Manager 2009-4-10 11:37:12 failed.
<input type="checkbox"/>	9418	4/9/2009 2:20:01 PM	/AddPac/Branch Gx	00_IVR_server		device 00_IVR_server all services are down.
<input type="checkbox"/>	9396	4/9/2009 10:57:37 AM	/AddPac/Branch AQ	NMS_IP_PBX_3...		device NMS_IP_PBX_31.13 all services down.
<input type="checkbox"/>	9239	4/6/2009 7:49:20 PM	/AddPac/Branch AQ	NMS Camera 2	172.16.253.118	device (NMS_Camera 2) interface 172.16.253.118 (172.16.253.118) not response or delete by administrator

Configuration

Smart Network Management System - Windows Internet Explorer

http://172.16.31.20/smartnms.htm

Smart Network Management System

NMS Account Configuration Monitoring Notification Fault Statistics View Help

Current Outage Devices [13] Site

Name	Service...	Availability
Branch AQ		
NMS Camera	6 of 12	50.000 %
NMS_IP_PBX...	3 of 3	0.000 %
Branch GX		
00_IVR_server	3 of 3	0.000 %
00_IVR_slave...	3 of 3	0.000 %
00_PS_server	3 of 3	0.000 %
00_PS_Slave...	2 of 3	33.333 %
00_FBT_server	3 of 3	0.000 %
IPNext 3000 ...	1 of 3	66.667 %
IPNext 3000 S...	1 of 3	66.667 %
UMS slave	3 of 3	0.000 %
HeadQuarter		
5th floor meeti...	1 of 1	0.000 %
UMS serverfo...	3 of 3	0.000 %
Subnetwork #2		
Center		
NMS_SOHD_...	2 of 2	0.000 %

Destination Path Name

default
onlyAlarmLamp

Configure Notification

External Notification | Alarm Lamp

E-Mail | SMS

Sender Email Address: nms@addpac.com

SMTP Server Host: 61.33.161.2

Authentication

Username: _____

Password: _____

Help Ok Cancel

Total destination paths : 2

Your Outstanding Notices (18)

Ack	ID	Send Time	Site	Device Name	IP Address	Service	Message
<input type="checkbox"/>	9535	4/10/2009 9:26:04 PM	/AddPac/Branch GX	00_FBT_server			device 00_FBT_server's all services are down.
<input type="checkbox"/>	9527	4/10/2009 5:34:10 PM	/AddPac/HeadQuarter	5th floor meeting...			device 5th floor meeting room phone device, all services are down.
<input type="checkbox"/>	9502	4/10/2009 3:34:29 PM	/Subnetwork #2/Cent...	NMS_SOHD_PBX			device NMS_SOHD_PBX, all services are down
<input type="checkbox"/>	9495	4/10/2009 11:37:12 AM	/AddPac/Branch GX	IPNext 3000 Slave	172.17.113.41	Call Manager	interface 172.17.113.41 (172.17.113.41) device (IPNext 3000 Slave) service Call Manager 2009-4-10 11:37:12 failed.
<input type="checkbox"/>	9494	4/10/2009 11:37:12 AM	/AddPac/Branch GX	IPNext 3000 Master	172.17.113.40	Call Manager	interface 172.17.113.40 (172.17.113.40) device (IPNext 3000 Master) service Call Manager 2009-4-10 11:37:12 failed
<input type="checkbox"/>	9418	4/9/2009 2:20:01 PM	/AddPac/Branch GX	00_IVR_server			device 00_IVR_server all services are down.
<input type="checkbox"/>	9396	4/9/2009 10:57:37 AM	/AddPac/Branch AQ	NMS_IP_PBX_3...			device NMS_IP_PBX_31.13 all services down.
<input type="checkbox"/>	9239	4/6/2009 7:49:20 PM	/AddPac/Branch AQ	NMS Camera 2	172.16.253.118		device (NMS_Camera 2) interface 172.16.253.118 (172.16.253.118) not response or delete by administrator

Your Outstanding Notices (18) | All Outstanding Notices (18)

4/13/2009 11:26:16 AM | 172.16.31.20:5101 | admin | Version 1.2.3384

Audible & Visible Alarm

notify operator (or administrator)
1. Alarm lamp blink (on&off) (visible)
2. play alarm sound (audible)

can synchronize with alarm lamp equipment

Site	Type	Outages	Availability	Description
AddPac	Sub Netw...	32 / 12 / 32	92%	AddPac Technology C...
Seoul	Sub Netw...	2 / 1 / 2	33%	Seoul subnetwork

Category	Outages	Availability
Desktop	0 / 0 / 1	100%
Network Camera	6 / 1 / 2	57%
Phone	1 / 1 / 3	66%
Server	27 / 11 / 22	42%
Switch	0 / 0 / 0	100%
WiFi Gateway	0 / 0 / 6	100%

Your Outstanding Notices (18)							
Ack	ID	Send Time	Site	Device Name	IP Address	Service	Message
<input type="checkbox"/>	9535	4/10/2009 9:26:04 PM	/AddPac/Branch GX	00_RBT_server			device 00_RBT_server's all services are down.
<input type="checkbox"/>	9527	4/10/2009 5:34:10 PM	/AddPac/HeadQuater	5th floor meeting...			device 5th floor meeting room phone device, all services are down.
<input type="checkbox"/>	9502	4/10/2009 3:34:29 PM	/Subnetwork #2/Cent...	NMS_SDHO_PBX			device NMS_SDHO_PBX, all services are down
<input type="checkbox"/>	9495	4/10/2009 11:37:12 AM	/AddPac/Branch GX	IPNext 3000 Slave	172.17.113.41	Call Manager	interface 172.17.113.41 (172.17.113.41) device (IPNext 3000 Slave) service Call Manager 2009-4-10 11:37:12 failed.
<input type="checkbox"/>	9494	4/10/2009 11:37:12 AM	/AddPac/Branch GX	IPNext 3000 Master	172.17.113.40	Call Manager	interface 172.17.113.40 (172.17.113.40) device (IPNext 3000 Master) service Call Manager 2009-4-10 11:37:12 failed.
<input type="checkbox"/>	9418	4/9/2009 2:20:01 PM	/AddPac/Branch GX	00_IVR_server			device 00_IVR_server all services are down.
<input type="checkbox"/>	9396	4/9/2009 10:57:37 AM	/AddPac/Branch AQ	NMS_IP_PBX_3...			device NMS_IP_PBX_31.13 all services down.
<input type="checkbox"/>	9239	4/6/2009 7:49:20 PM	/AddPac/Branch AQ	NMS Camera 2	172.16.253.118		device (NMS Camera 2) interface 172.16.253.118 (172.16.253.118) not response or delete by administrator
<input type="checkbox"/>	9238	4/6/2009 7:49:20 PM	/AddPac/Branch AQ	NMS Camera 2	172.16.253.118	ICMP	device (NMS Camera 2) interface 172.16.253.118 (172.16.253.118) service ICMP not response or deleted by administrator
<input type="checkbox"/>	9237	4/6/2009 7:49:20 PM	/AddPac/Branch AQ	NMS Camera 2	172.16.253.118	SNMP	device (NMS Camera 2) interface 172.16.253.118 (172.16.253.118) service SNMP not response or deleted by administrator
<input type="checkbox"/>	9236	4/6/2009 7:41:25 PM	/AddPac/Branch AQ	NMS Camera 2	172.16.253.118	ICMP	device (NMS Camera 2) interface 172.16.253.118 (172.16.253.118) service ICMP not response or deleted by administrator
<input type="checkbox"/>	9235	4/6/2009 7:41:25 PM	/AddPac/Branch AQ	NMS Camera 2	172.16.253.118	SNMP	device (NMS Camera 2) interface 172.16.253.118 (172.16.253.118) service SNMP not response or deleted by administrator

Fault Statistics

- analyze for a fault event with graph and detailed list data
- Report form generation and print out for statistics result

Fault Statistics

The screenshot displays the Smart Network Management System (NMS) interface. The top navigation bar includes 'NMS', 'Account', 'Configuration', 'Monitoring', 'Notification', 'Fault', 'Statistics', 'View', and 'Help'. The main content area is divided into several sections:

- Event Summary Table:** A table on the left showing event statistics for various dates from 2009-04-04 to 2009-04-13. Columns include Event Time, Outsta..., Ackno..., Not Clo..., Cleared, and In Pr.
- Search Condition:** A section with dropdown menus for 'Hour' (set to 4/ 9/2009) and 'Site' (set to Branch A, Branch AQ, B).
- Fault Statistics (Site):** A bar chart showing fault counts over time for different sites. The legend includes Seoul, HeadQuarter, Center, Branch TG, Branch KT, Branch GX, Branch B, Branch AQ, and Branch A.
- Detailed Data Table:** A table for the date 4/9/2009 showing fault counts for various sites and a total. The table has columns for Time, Branch A, Branch AQ, Branch B, Branch GX, Branch KT, Branch TG, Center, HeadQuarter, Seoul, and Total.
- Your Outstanding Notices (18):** A table at the bottom showing a list of notices with columns for Ack, ID, Send Time, Site, Device Name, IP Address, Service, and Message.

Two red callout boxes provide additional context:

- Top Callout:** "display graph for fault statistics with various search condition" (with an arrow pointing to the search bar and chart).
- Bottom Callout:** "display detailed data for fault statistics" (with an arrow pointing to the detailed data table).

Fault Statistics – Report Generation

report generation for fault statistics and print out the result

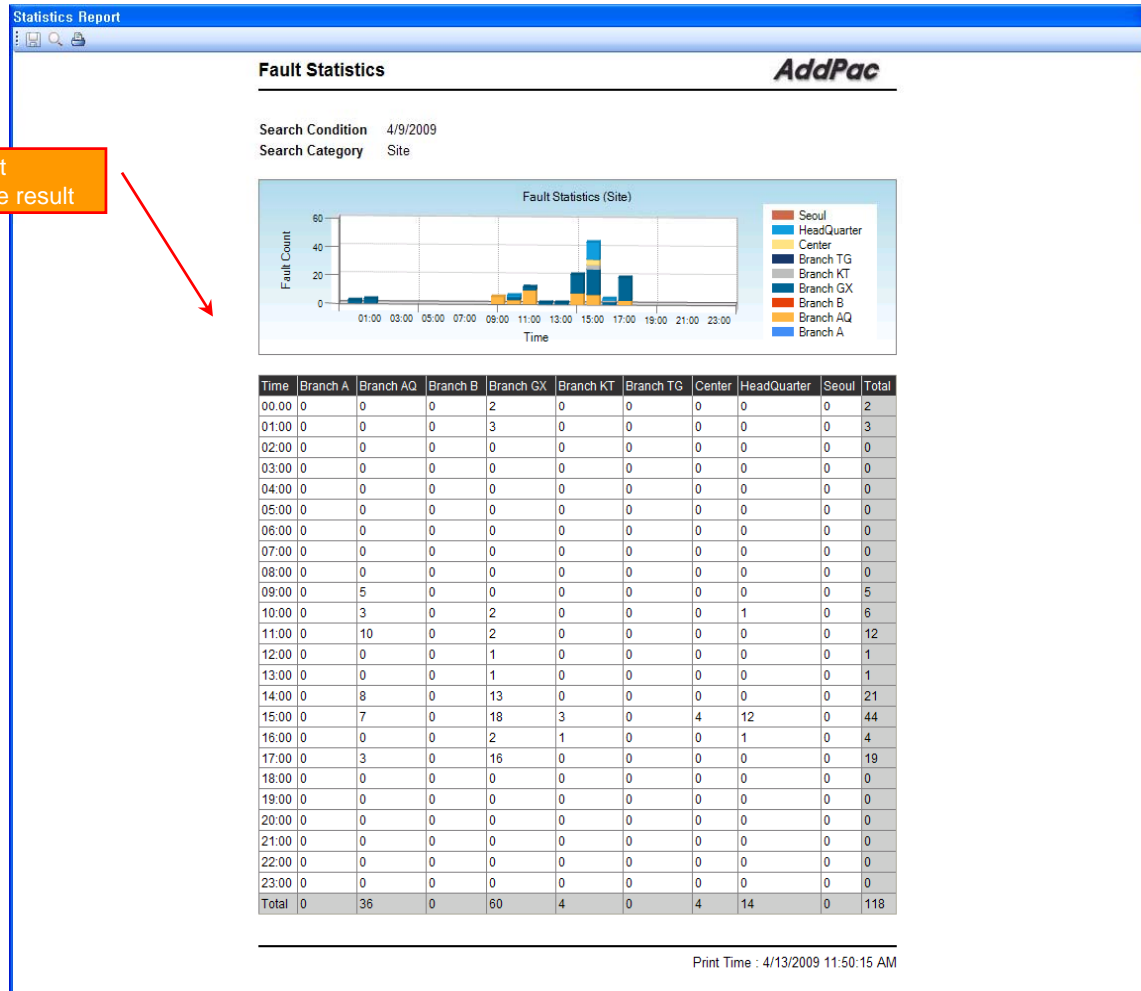

Model & Service Management

- Define new model with provided template image & properties
- Customize data collection with standard protocol such as TCP, SNMP

Device Model Management

manage device model with various properties such as model image

model image repository for selection

Name	Description
AddPac	AddPac Technology C...
Branch AQ	Branch AQ
Branch GX	Branch GX description
Branch KT	
HeadQuarter	Main HeadQuarter Cen...
Seoul	Seoul subnetwork
Seoul East Area	Seoul East Area
Branch B	
GangNamGu	GangNamGu
Branch TG	Yeoksam Area
SeoChoGu	seoul seochodistrict
Seoul West Area	Seoul West Area
Gangseo Area	Gangseo Area
Seoul	
MokDong Area	MokDong Area

Model Name	Category
AP-IP200	Phone
AP-IP300	Phone
AP-IPC	Network Camera
AP-IPC250M	Network Camera
AP-IVR1000	Server
AP-MC1000	Server
AP-MC3000	Server
AP-MC5000	Server
AP-NR2000	Server
AP-PS2000	Server
AP-RBT1000	Server
AP-RS2000	Server
AP-UMS1000	Server
AP-UMS2000	Server
AP-VC2000	Phone
AP-VP200	Phone
AP-VP300	Phone
AP-VP350	Phone
AP-VP500	Phone
IPNext1000	Server
IPNext1000	Server
IPNext180	Server
IPNext200	Server

Model Name	Category	SSCP Port	Model Image
AP-IPC250M	Network Camera	5061 (1~65535)	

Model Image Management

Device Name	IP Address	Service	Message
00_RBT_server			device 00_RBT_server's all services are down.
5th floor meeting...			device 5th floor meeting room phone device, all se...
NMS_SDHO_PBX			device NMS_SDHO_PBX, all services are down
IPNext 3000 Slave	172.17.113.41	Call Manager	interface 172.17.113.41 (172.17.113.41) device (If...
IPNext 3000 Master	172.17.113.4		Call Manager 2009-4-10 11:37:12 failed.
00_IVR_server			device (00_IVR_server) interface 172.16.253.118...
NMS_IP_PBX_3...			...
NMS Camera 2	172.16.253.1		...
NMS Camera 2	172.16.253.118	ICMP	device (NMS Camera 2) interface 172.16.253.118...
NMS Camera 2	172.16.253.118	SNMP	device (NMS Camera 2) interface 172.16.253.118...
NMC Camera 2	172.16.253.110	ICMP	device(NMS Camera 2) interface 172.16.253.118...
NMS Camera 2	172.16.253.118	SNMP	device(NMS Camera 2) interface 172.16.253.118...

Service Definition

define the service for data collection, current status with standard protocol such as TCP or SNMP

The screenshot displays the Smart Network Management System (SNMS) interface within a Windows Internet Explorer browser. The main window shows a tree view of network sites and a table of services. A 'Service Properties' dialog box is open, showing the configuration for a service named 'Camera Operation Status' using the SNMP protocol on port 161. The dialog includes fields for Service Name, Protocol, Port, Interval (30000 msec), Timeout (3000 msec), and Retry (3).

Below the main window, a 'Your Outstanding Notices (18)' table is visible, listing various alerts. A second 'Service Properties' dialog box is also shown, displaying the 'Service Condition' configuration, which includes a Service OID of 1.3.6.1.4.1.4855.7.51.1.3.0 and a condition set to 'Operator = 1'.

Service Name	Protocol	Port
Call Manager	SNMP	161
Presence	SNMP	161
Media	SNMP	161
NMS	SNMP	161
RtpProxy	SNMP	161
MCU	SNMP	161
IVR	SNMP	161
Recording	SNMP	161
Tomcat	TCP	8080
FTP	TCP	21
Camera Pan	SNMP	161
Camera Tilt	SNMP	161
Camera Zoom	SNMP	161
Camera Operation Status	SNMP	161

Ack	ID	Send Time	Site	Device Name	IP Address	Service	Message
<input type="checkbox"/>	9535	4/10/2009 9:26:04 PM	/AddPac/Branch GX	00_RBT_server		device	00_RBT_serv
<input type="checkbox"/>	9527	4/10/2009 5:34:10 PM	/AddPac/HeadQuarter	5th floor meeting_		device	5th floor meet
<input type="checkbox"/>	9502	4/10/2009 3:34:29 PM	/Subnetwork #2/Cent...	NMS_SOH0_PBX		device	NMS_SOH0_PBX
<input type="checkbox"/>	9495	4/10/2009 11:37:12 AM	/AddPac/Branch GX	IPNext 3000 Slave	172.17.113.41	Call Manager	interface 172.17.113.
<input type="checkbox"/>	9494	4/10/2009 11:37:12 AM	/AddPac/Branch GX	IPNext 3000 Master	172.17.113.40	Call Manager	interface 172.17.113.
<input type="checkbox"/>	9418	4/9/2009 2:20:01 PM	/AddPac/Branch GX	00_IVR_server		device	00_IVR_serv
<input type="checkbox"/>	9396	4/9/2009 10:57:37 AM	/AddPac/Branch AQ	NMS_IP_PBX_3		device	NMS_IP_PBX
<input type="checkbox"/>	9239	4/6/2009 7:49:20 PM	/AddPac/Branch AQ	NMS Camera 2	172.16.253.118	ICMP	response or delete by
<input type="checkbox"/>	9238	4/6/2009 7:49:20 PM	/AddPac/Branch AQ	NMS Camera 2	172.16.253.118	ICMP	ICMP not response o
<input type="checkbox"/>	9237	4/6/2009 7:49:20 PM	/AddPac/Branch AQ	NMS Camera 2	172.16.253.118	SNMP	SNMP not response
<input type="checkbox"/>	9236	4/6/2009 7:41:25 PM	/AddPac/Branch AQ	NMS Camera 2	172.16.253.110	ICMP	ICMP not response o



Thank you!

AddPac Technology Co., Ltd.
Sales and Marketing

Phone +82.2.568.3848 (KOREA)

FAX +82.2.568.3847 (KOREA)

E-mail : sales@addpac.com