

AP-AC50 5 Inch Touch Screen LCD IP Door Phone

High Performance SIP Door Phone Solution

Preliminary Product Overview

(Without notice, following described technical spec. can be changed)



AddPac

AddPac Technology

Sales and Marketing

Contents

- Product Overview
- Product Highlights
- Hardware Specification
- Software Service
- Audio & Voice Service and Features
- OSD Software Features
- Smart Web Manager
- Application Area
- Ordering Information

Product Overview

AP-AC50 IP Door Phone

- High Performance IP Door Phone Solution
- Touch Screen 5Inch TFT Color LCD, Internal MIC & Speaker
- SIP VoIP Signaling Stack Embedded
- High-performance Video/Voice Codec Support
 - H.264/MPEG4, G.711, etc
- One(1) 10/100Mbps Fast Ethernet
- Option : PoE(Power over Ethernet) Support
- High Quality Speaker Phone Features
- Powerful Acoustic Echo Canceller Chip Embedded
- Powerful Network Protocols (PPPoE, DHCP, Static Routing, etc)
- Firmware Upgradeable Architecture
- Advanced Voice QoS Mechanism

Product Highlights

AP-AC50 IP Door Phone

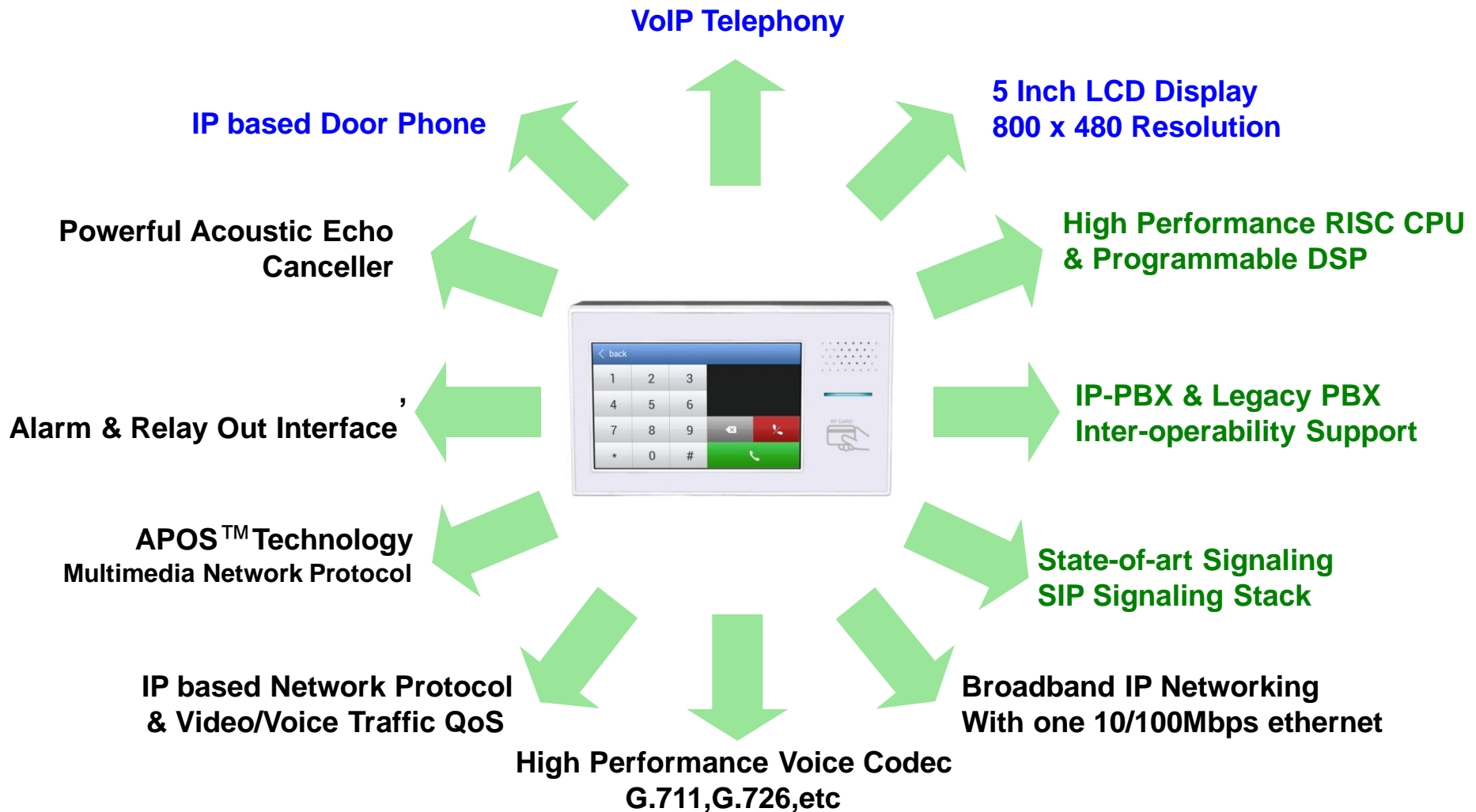

Multimedia Service

AP-AC50 IP Door Phone

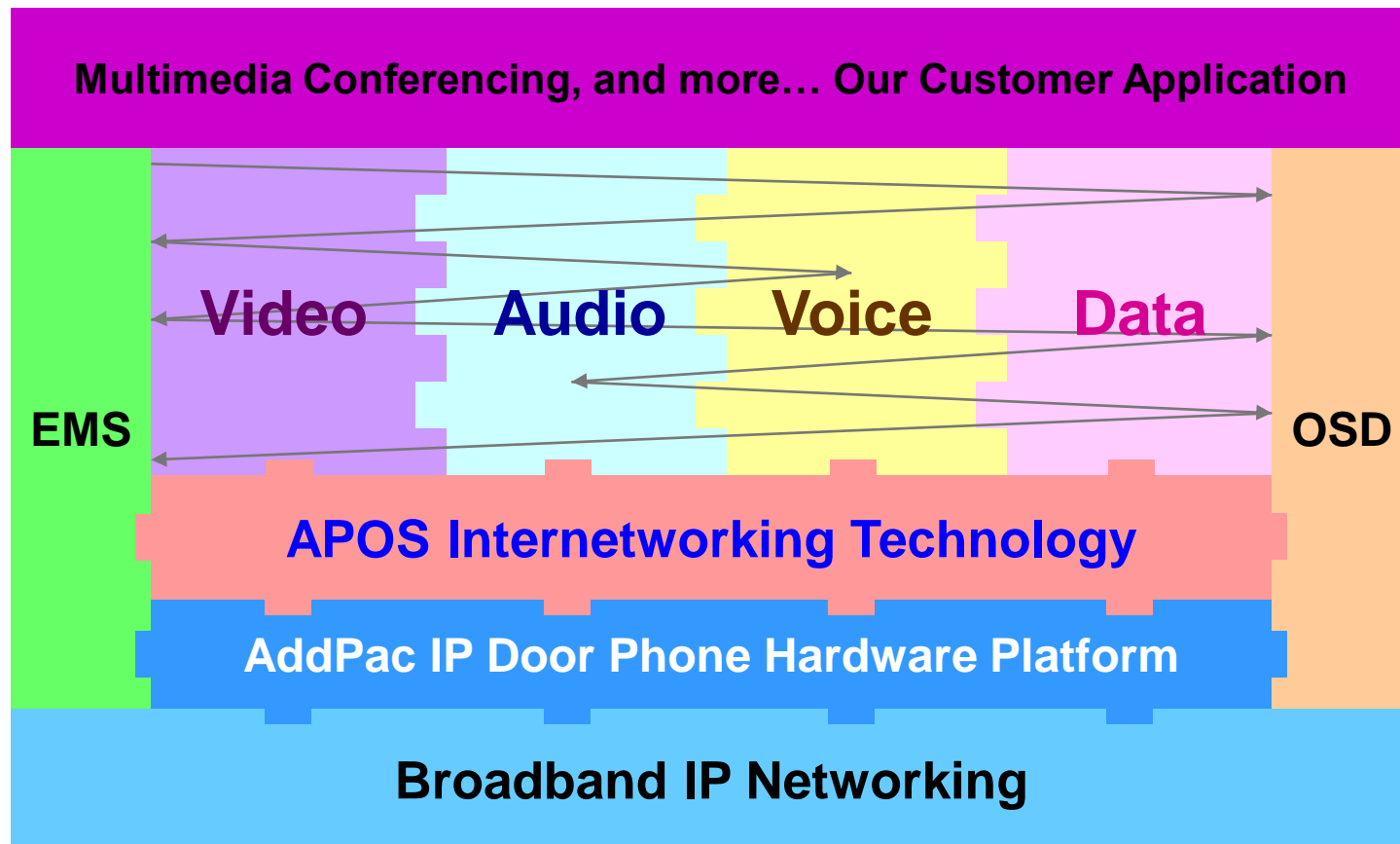

- APOS : AddPac Internetworking Operating System
- OSD : On- Screen Display
- EMS : Element Management System

Hardware Specification

AP-AC50 IP Door Phone

RISC
CPU

High-end
DSP

- RISC+DSP Microprocessor Computing Power
- Audio and Voice Interface
 - Internal MIC
 - Internal Speaker
- Touch Screen TFT Color LCD Interface
 - 5 Inch Color LCD
- Network Interface
 - One(1) 10/100Mbps Fast Ethernet
- Alarm & Relay Out Interface (door open, etc)
- Power Supply
 - Power over Ethernet (Option)
 - External Power Supply

Hardware Specification

AP-AC50 IP Door Phone

RISC
CPU

High-end
DSP

- **Acoustic Echo Canceller**
 - Full-duplex operation during double-talk situations
 - One channel AEC, one channel LEC up to 256ms shared
 - Cancels echoes with up to 10dB echo return
 - Advanced noise reduction(up to 20dB)
- **Speaker**
 - Impedance : 8 +/-15%ohm at 1kHz, 1.0 Vrms
 - Sound Pressure : 90 +/- 3dB at 0.1W/10 CM
at 800Hz, 1.0kHz, 1.2kHz, 1.5kHz
 - Resonance Level : 550Hz +/- 20%Hz at Fo Hz, 1.0Vrms
 - Frequency Range : Fo Hz ~20kHz
 - Input Power : Normal : 1.0 W, Max : 2.0W
- **Audio Amplifier**
 - 1-W BTL Output(5V, 0.11 % THD+N)
 - Uncompensated Gains of 2 to 20 (BTL Mode)
 - Thermal and Shot-circuit Protection
 - High Supply Ripple Rejection Ratio
- **PoE(Power over Ethernet)**
 - IEEE802.3af compliant
 - Input voltage range 36V to 57V
 - Short-circuit Protection

Hardware Specification

AP-AC50 IP Door Phone

RISC
CPU

High-end
DSP

Front Side

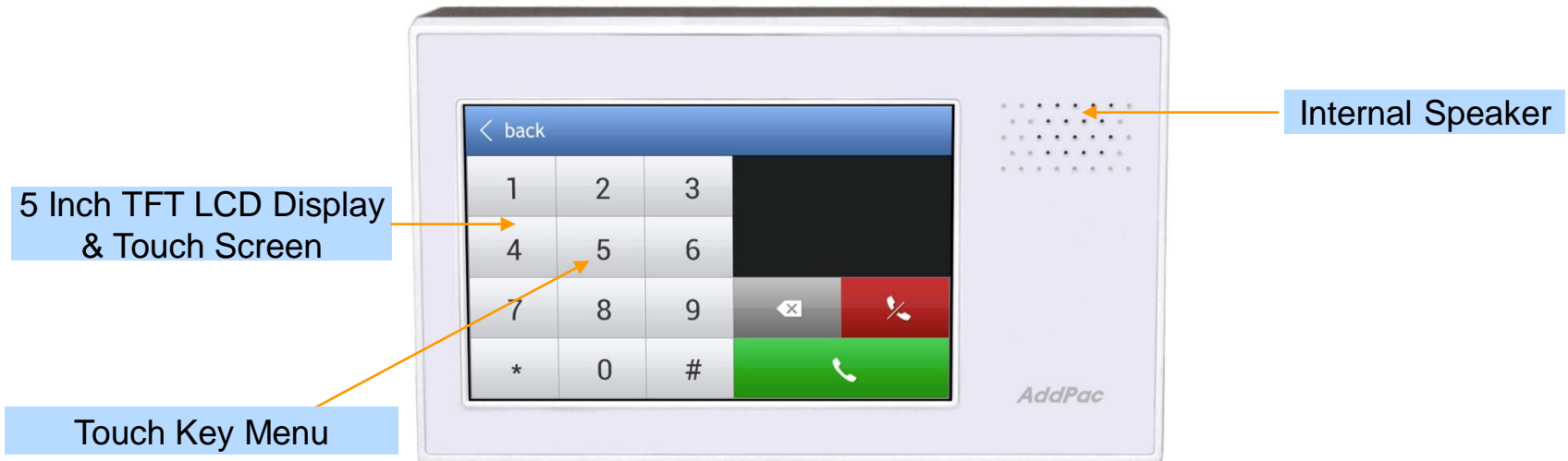

Hardware Specification

AP-AC20 IP Door Phone

RISC
CPU

High-end
DSP

Back Side

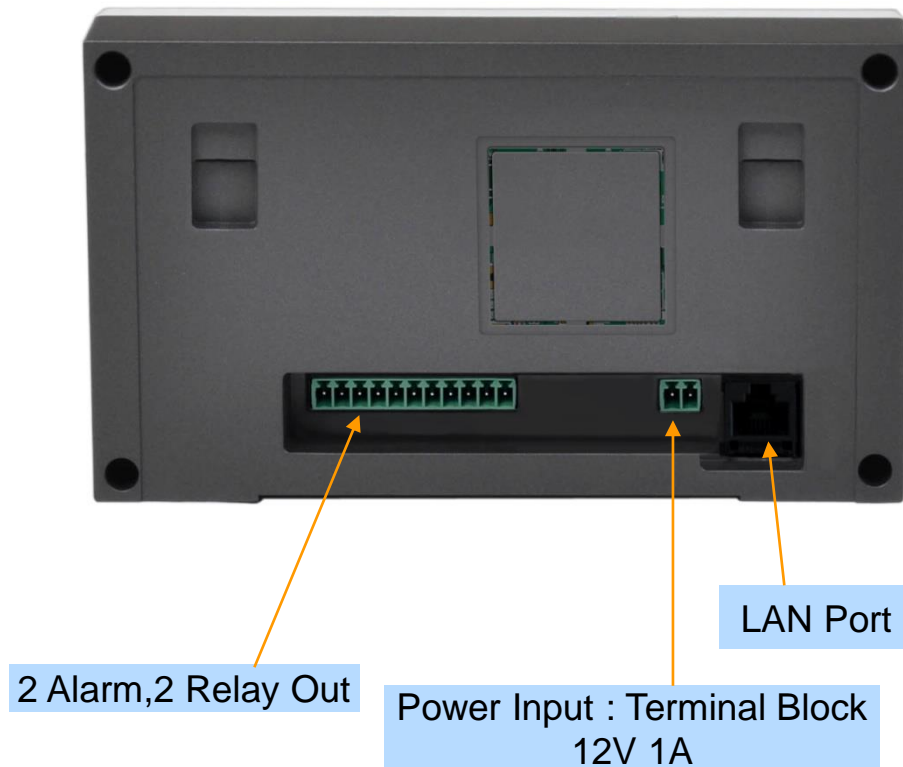

Hardware Specification

AP-AC50 IP Door Phone

RISC
CPU

High-end
DSP

Power Supply



Example



Software Service

AP-AC50 IP Door Phone

- **Built-in AddPac APOS Internetworking Software**
 - Scalability, Functionality, and Stability Features
 - Voice & Video Traffic QoS Control
- **Programmable Audio, and Voice Services**
 - Audio, and Voice Codec
- **Firmware Upgradeable DSP Architecture**
- **OSD (On-screen Display) Function Support**
- **Industry Standard IP based Network Protocol Features**

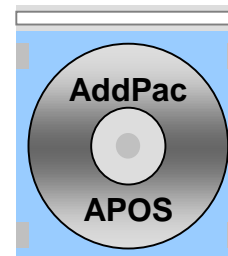

Audio & Voice Service and Features

AP-AC50 IP Door Phone

- **VoIP based Signaling Protocol Support**
 - H.323, SIP Signaling Protocol Stack
- **High-performance Audio & Voice Codec Support**
 - G.711,G.726, Audio Codec
- **Enhanced QoS Management Features for Voice Traffics**

Smart Web Manager (Example)

Smart Web Manager

AP-AC50 IP Door Phone

- Main Screen
- System
 - Language
 - LAN Setup
 - DACS
 - Display
 - File Browser
- SIP Call & Media
 - SIP (Session Initiation Protocol)
 - Speed Dial
 - Media
- Miscellaneous
 - Door Control and Test
 - Network Test

Smart Web Manager : Main Screen

AP-AC50 IP Door Phone

Smart Web Manager
www.addpac.com

Initialization Rebooting Save Telnet

System

- Language
- LAN Setup
- DACS
- Display Manager
- File Browser

Call & Media

- Server SIP
- Speed Dial
- Media

Miscellaneous

- Ping
- Door Open

Configure Language

한국어

English

Apply

Information

AddPac Technology
Model : VAC50_G2
DACS : (0)
DACS Registration : Fail
SIP : 172.17.250.250(5060)

Description

Choose the basic language to be applied. English is set at default.

Menu Tree

Output Screen after
Menu Select

System Information and
Help Message

Smart Web Manager : SIP configuration

AP-AC50 IP Door Phone

SIP (Session Initiation Protocol)

SIP server check if exist.

Use SIP Server 

Yes No

Primary SIP Server 

Server address and Port (default 5060)

Secondary SIP Server 

Server address and Port (default 5060)

Local Domain Name 

(SIP userpart of authentication)

SIP Signaling Port 

(default 5060, between 1 to 65535)

Register Expiration 

(in seconds, default 60, between 10 to 86400)

Session Re-Fresh 

INVITE UPDATE

Session Expire Time 

(in seconds, default 1800, between 30 to 86400, 0 = disable)

Min-SE

(in seconds, default 1800, between 30 to 86400)

Extension

Extension Number, Password

SIP Basic Information Display

Telephone Line Number and Password Configuration Same Information is used when DACS is connected

AP-AC50 IP Door Phone

Application Area

- Point-to-Point Application (Simple Application)
 - All IP Environment
- Point-to-Multipoint Application
 - All AddPac Solution
(Call Manager + Door Access Control Server)
 - Legacy PBX Environment
 - Legacy IP-PBX Environment

Point-to-Point Connection (Simple Appl.)

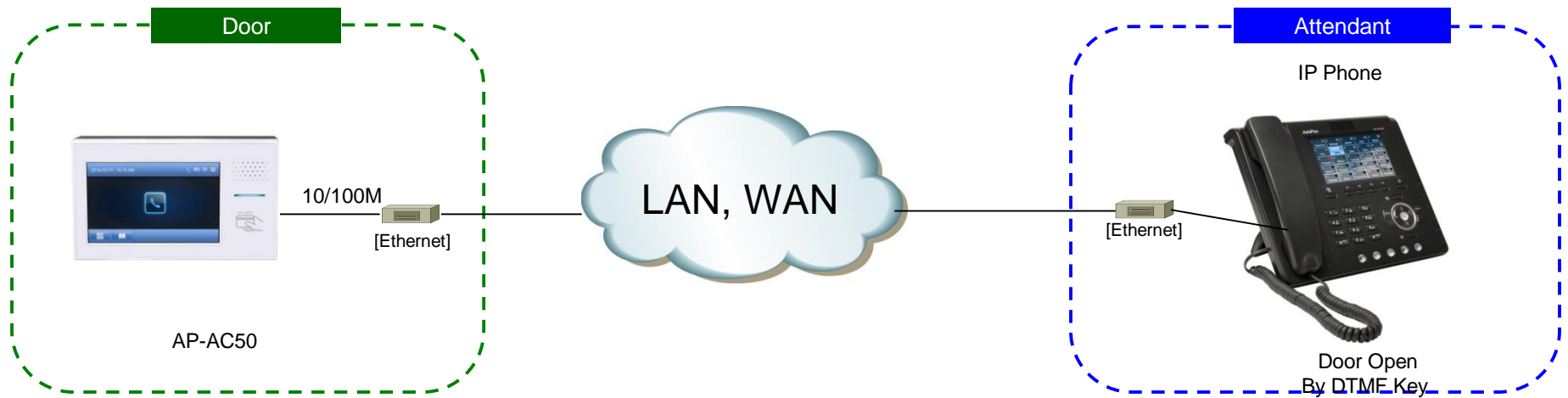

Integrated Door Access Control and Call Control (All AddPac Solution)

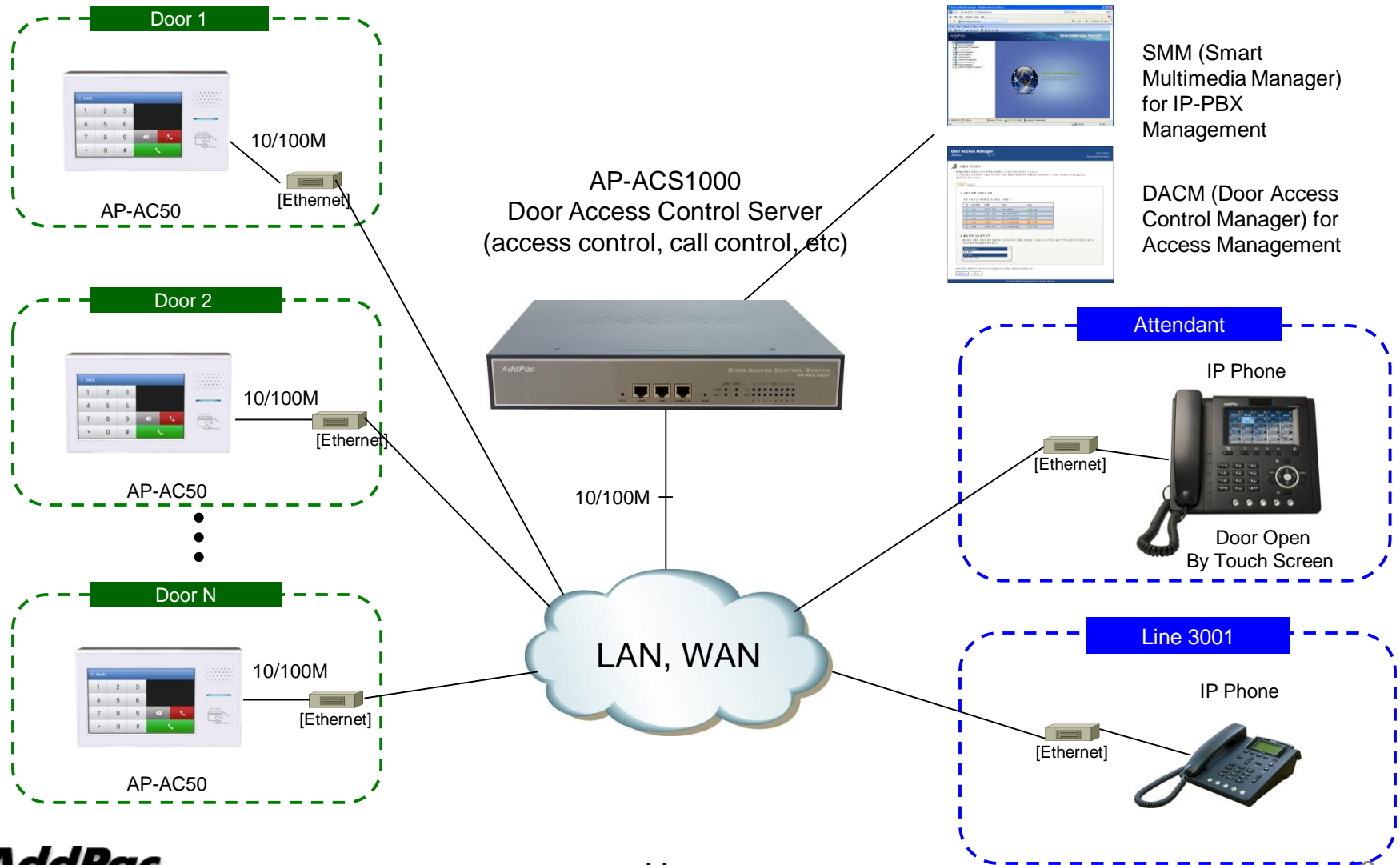

Legacy PBX Environment

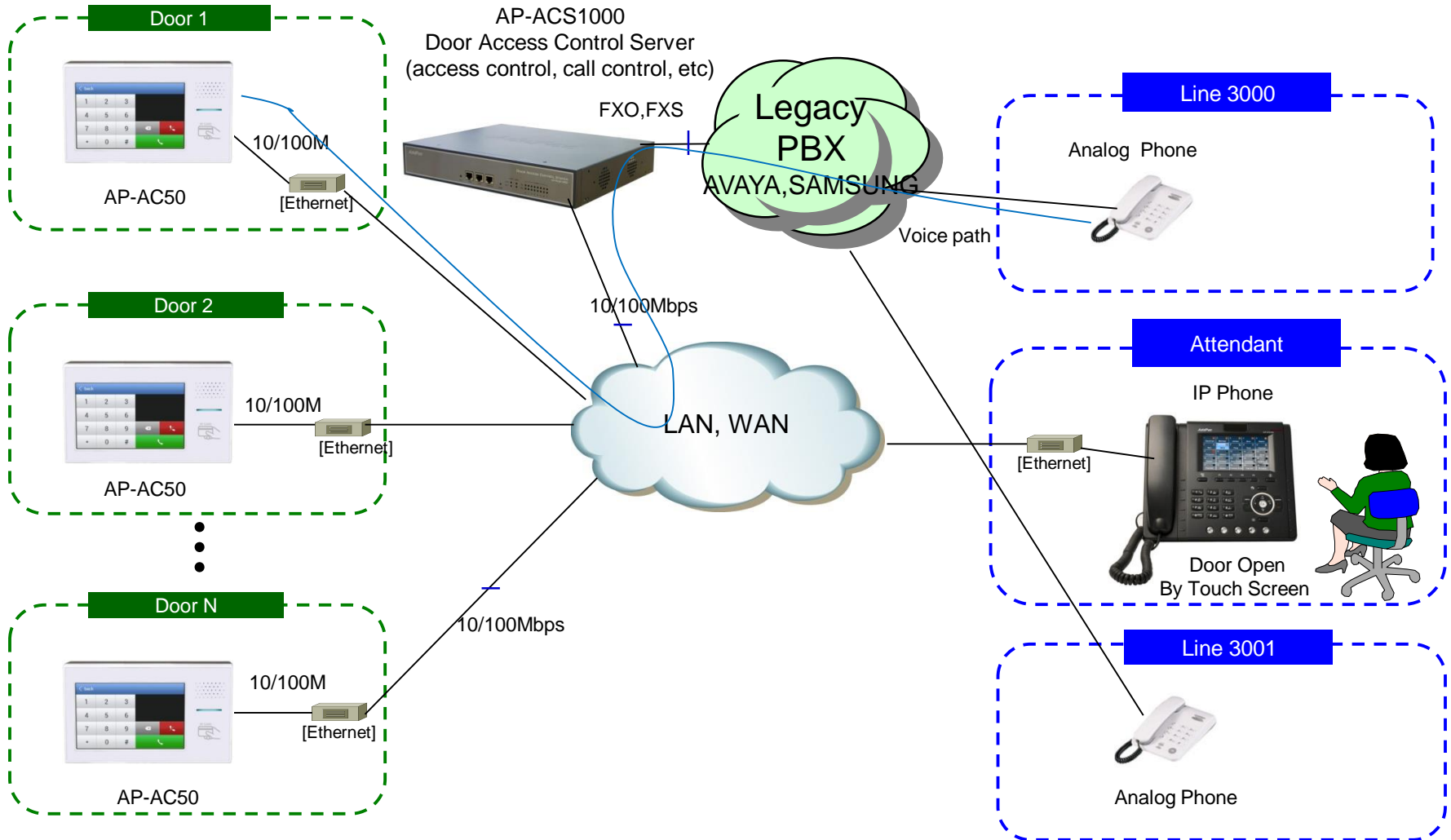

Legacy IP-PBX Environment

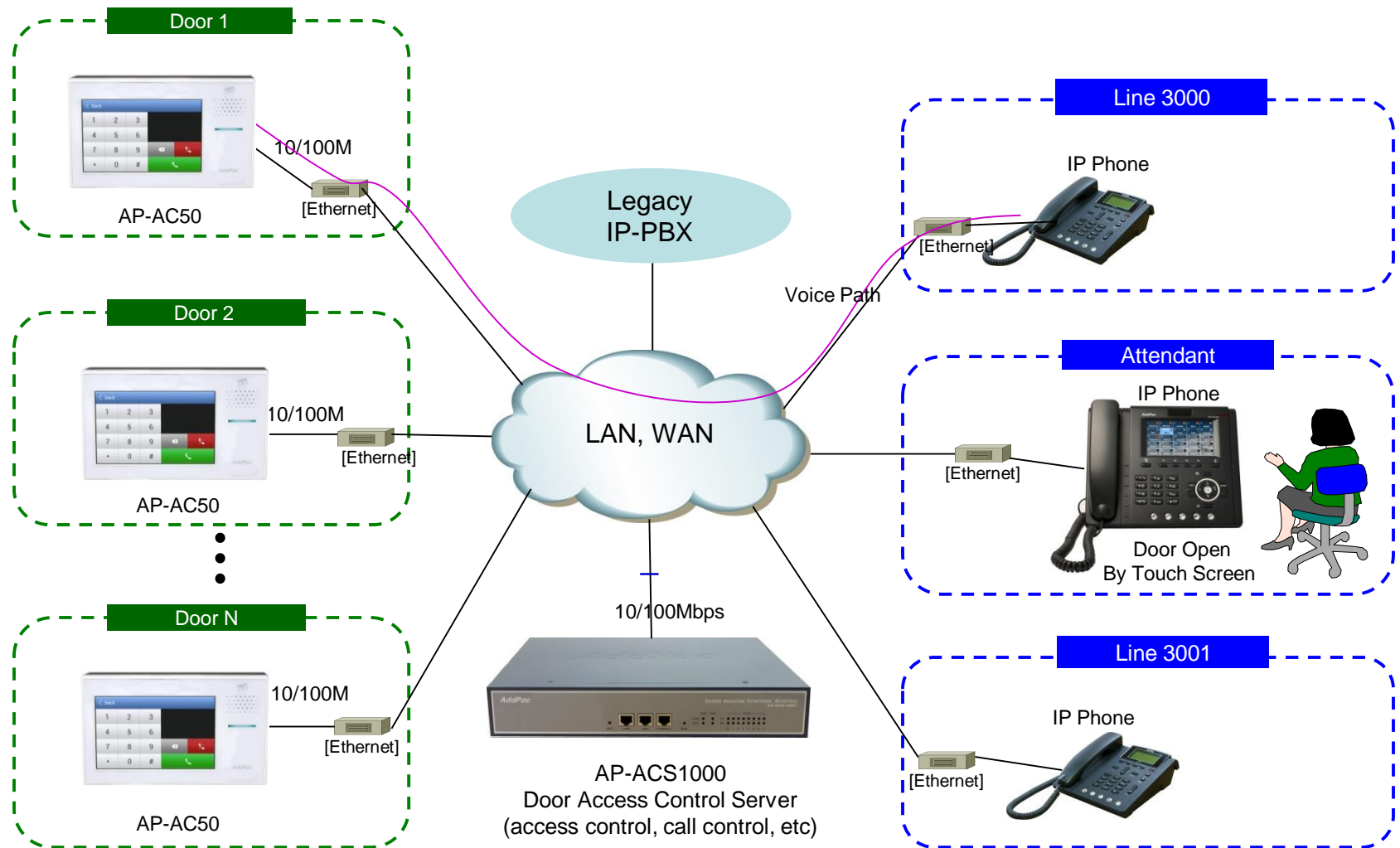

Ordering Information

- **AP-AC50 IP Door Phone Hardware**
 - AP-AC50 Video Phone Main Body
 - RISC Microprocessor with High-end Programmable DSP Architecture
 - Touch Screen 5 Inch Color LCD
 - Internal MIC, Internal Speaker
 - 1-ports 10/100Mbps Fast Ethernet
 - Option : PoE Interface
 - Including Network Cable Set & Ext. Power Supply, etc.
- **Built-in APOS Internetworking Software for AP-AC50**
- **Including 1 Year Hardware Warranty**
- **Product Documents**
 - Install and Operation Guide (PDF)
- **Pricing**
 - AddPac Technology Regional Sales Manager
 - Authorized Sales and Marketing Representatives
 - Please Contact www.addpac.com

Thank you!

AddPac Technology Co., Ltd.
Sales and Marketing

Phone +82.2.568.3848 (KOREA)

FAX +82.2.568.3847 (KOREA)

E-mail sales@addpac.com