

Satellite based RoIP Application



AddPac

AddPac Technology

2015, Sales and Marketing

www.addpac.com

Contents

- Satellite RoIP Network Service Diagram
- Satellite LMR (Land to Mobile Radio) Service Example
- Satellite RoIP Message Flow
- Satellite RoIP Solution Devices
 - IPNext600PTT IP-PBX
 - AP2610 E&M VoIP Gateway

Satellite RoIP Network Service Diagram

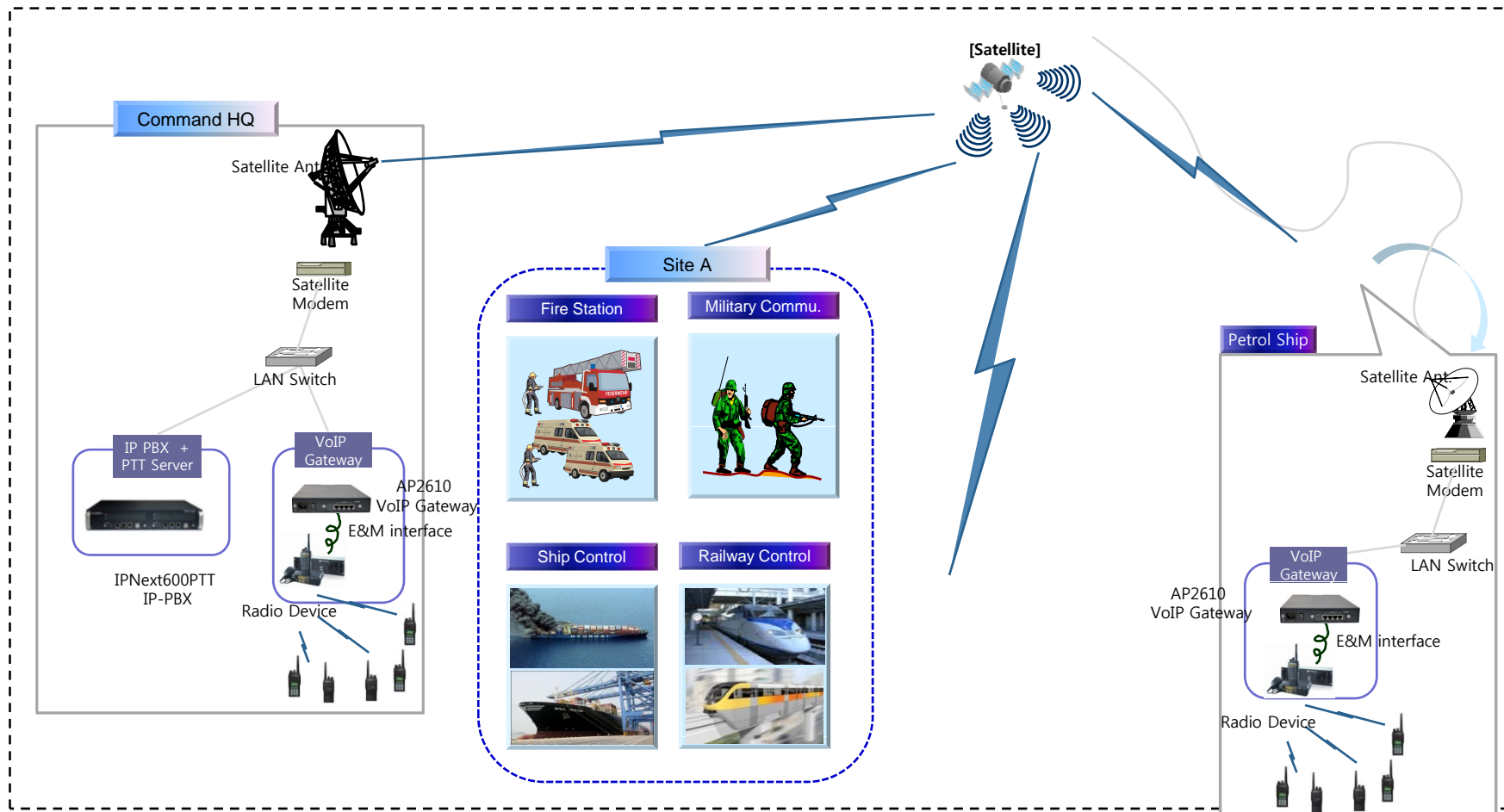

LMR Service Examples

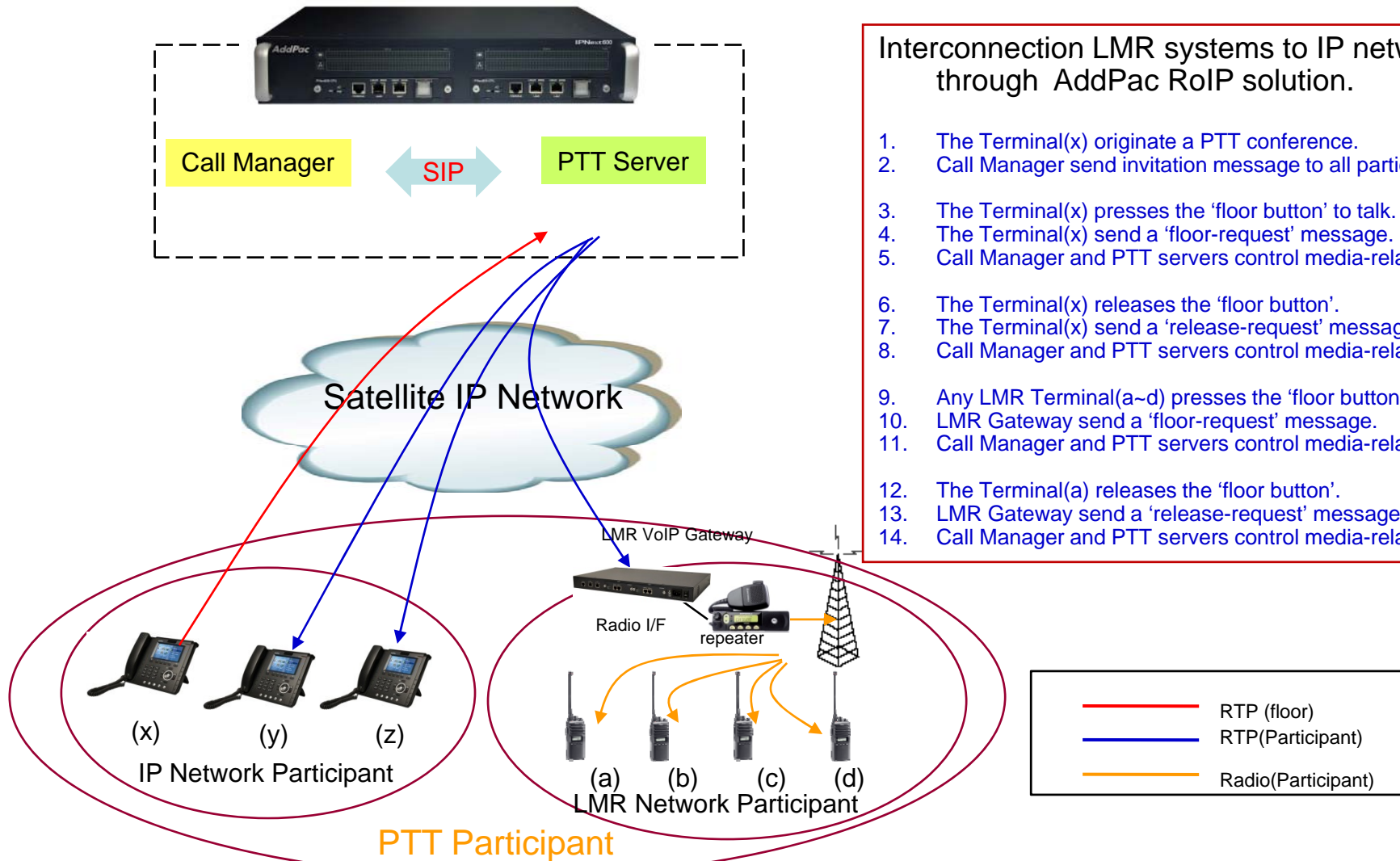

Interconnection LMR systems to IP network through AddPac RoIP solution.

1. The Terminal(x) originate a PTT conference.
2. Call Manager send invitation message to all participant.
3. The Terminal(x) presses the 'floor button' to talk.
4. The Terminal(x) send a 'floor-request' message.
5. Call Manager and PTT servers control media-relay.
6. The Terminal(x) releases the 'floor button'.
7. The Terminal(x) send a 'release-request' message.
8. Call Manager and PTT servers control media-relay.
9. Any LMR Terminal(a~d) presses the 'floor button' to talk.
10. LMR Gateway send a 'floor-request' message.
11. Call Manager and PTT servers control media-relay.
12. The Terminal(a) releases the 'floor button'.
13. LMR Gateway send a 'release-request' message.
14. Call Manager and PTT servers control media-relay.

RoIP System Message Flow

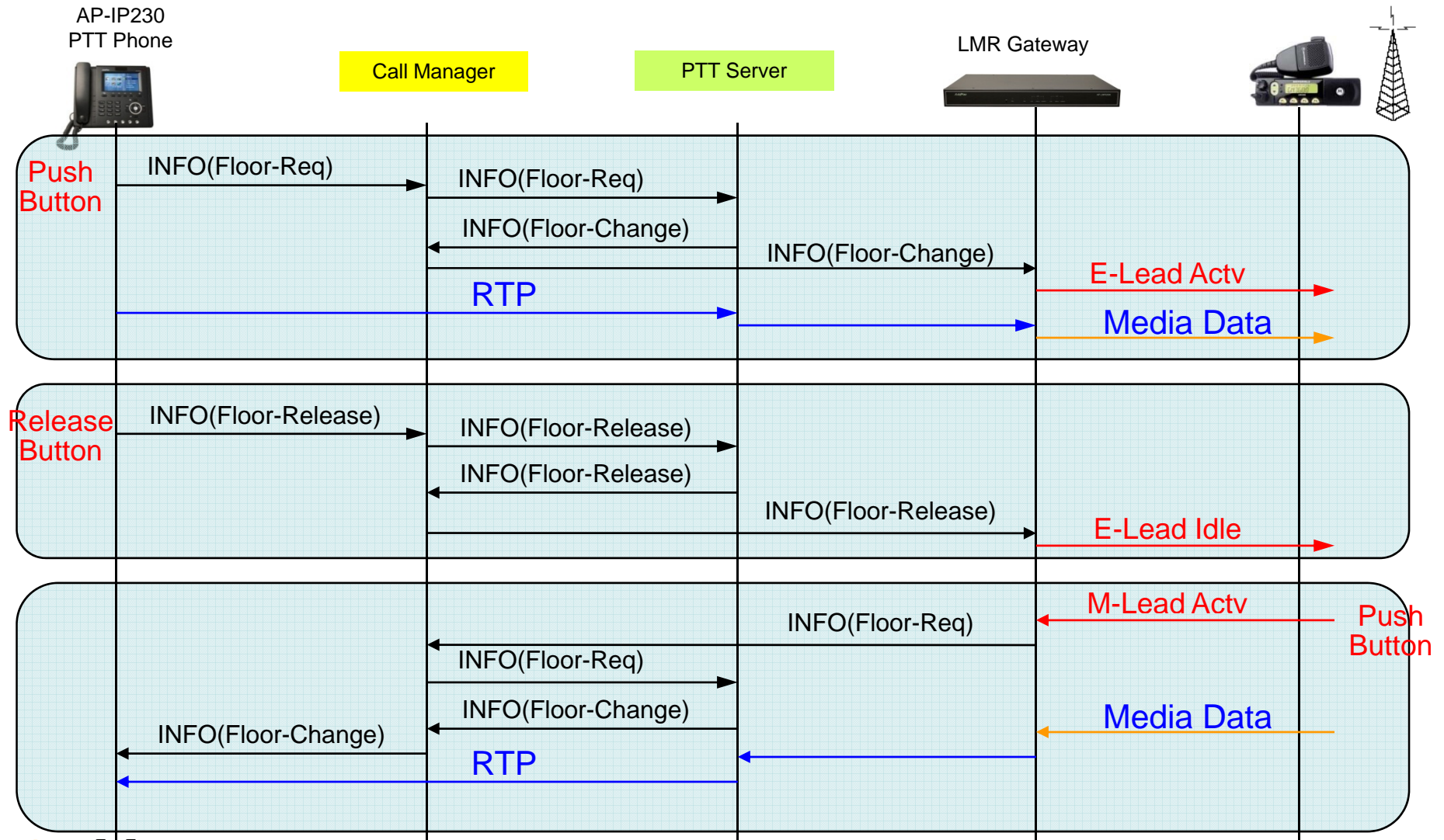



Satellite RoIP Solution Devices



IPNext600 PTT IP-PBX (One System, Dual IP-PBX)

Contents

- Product Overview
- Hardware Specification
- PTT Service
- PTT Media Gateway Service
- Smart Multimedia Manager for PTT
- Application Area

Product Overview

IPNext600 PTT Next Generation IP-PBX System

- SIP Application Server, Proxy, Registrar and Location Server
- Multiple ITSP Trunk with SIP & H.323 Accounts Support
- High Performance PTT Server Solution
- Dual System Redundancy Architecture
 - Two(2) Fast Ethernet Interface / System
- High Performance RISC Architecture
- Powerful Network Protocols (PPPoE, DHCP, Static Routing, etc)
- IPv4/IPv6 Dual Stack
- RTP Proxy Function Embedded for Private IP and IPv6 Address Interworking
- User Presence Service Features for Smart Multimedia Messenger and Smart IP Phone
- IVR Scenario Editor, Voice Mail, Media Service (Coloring), Conference
- Firmware Upgradeable Architecture
- Smart Multimedia Manager for IP-PBX Management
- Smart Messenger Service (click to dial) for Unified Communication
- Smart NMS for Large Scale Deployment
- Advanced Voice QoS Mechanism
- Dual Redundancy Power Module
- Various IP Terminal Support

Hardware Specification

IPNext600 PTT Next Generation IP-PBX System

RISC
CPU

- 64bit High-End Microprocessor Computing Power
- Main Chassis
 - Dual Redundancy CPU Boards for System Fault Tolerant
 - Two(2) 10/100Mbps Gigabit Ethernet
 - One(1) RS-232C Console (RJ45)
 - Dual Redundancy Power Supply Module
 - Hot-Swap Features



Hardware Specification

IPNext600 PTT Next Generation IP-PBX System

RISC
CPU

IPNext600 PTT Front Side

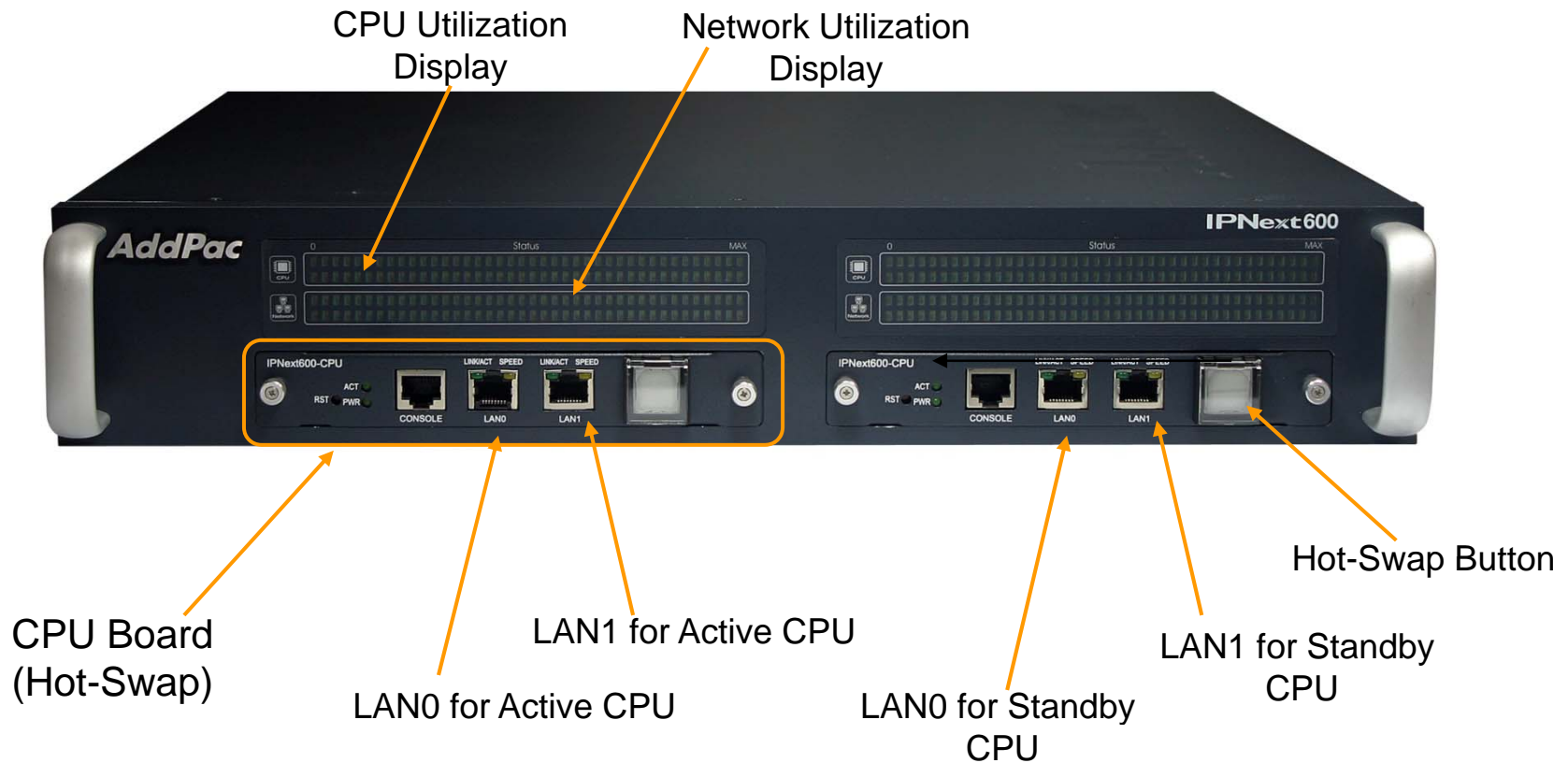

Hardware Specification

IPNext600 PTT Next Generation IP-PBX System

RISC
CPU

IPNext600 PTT Back Side

Dual Power Supply
Modules
(Hot-Swap)



PSU Module A

PSU Module B

Power On/Off Switch
for System

PTT Server Service

IPNext600 PTT Next Generation IP-PBX System

- IP based PTT Service Support
- Dial-Out based PTT Service Support
 - Multi-Session, Multi-Group
 - PtP (Point-to-Point) Service
- Advanced PTT Server Features
 - 1:1 PTT
 - Group PTT
 - Emergency PTT with Alarm Notification
- Emergency PTT Service Support
- IP-PBX Interworking Service
- IP Terminal Interworking Service (Wi-Fi Phone, IP Phones, Soft Phone, Smart Phone Application)
- PTT Solution with Outstanding Network Service Capability

IP based PTT Call Service Examples(1/3)

IPNext600 PTT Next Generation IP-PBX System

Multi PTT Group Support

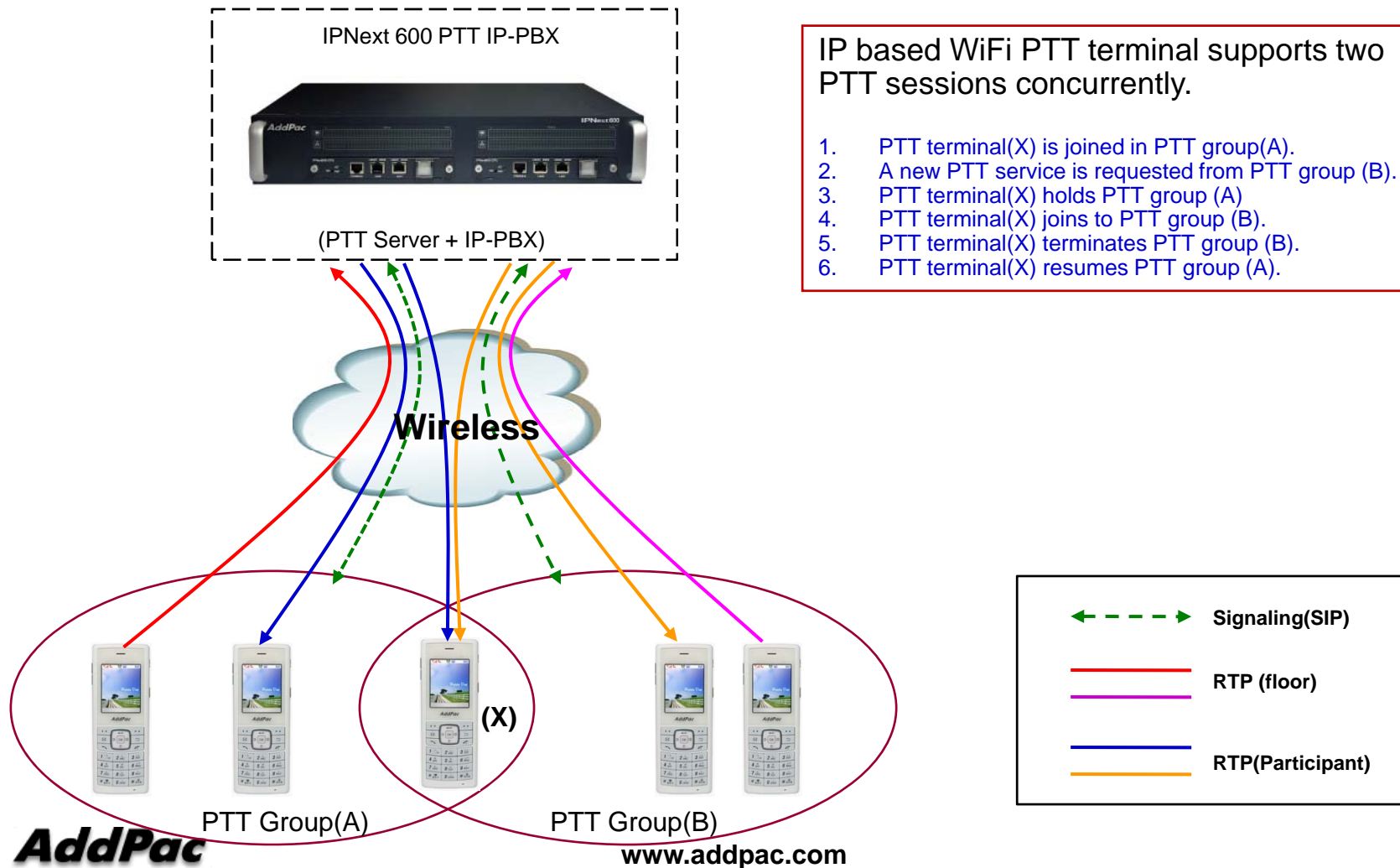

- IP based WiFi PTT terminal supports two PTT sessions concurrently.
1. PTT terminal(X) is joined in PTT group(A).
 2. A new PTT service is requested from PTT group (B).
 3. PTT terminal(X) holds PTT group (A)
 4. PTT terminal(X) joins to PTT group (B).
 5. PTT terminal(X) terminates PTT group (B).
 6. PTT terminal(X) resumes PTT group (A).

IP based PTT Call Service Examples(2/3)

IPNext600 PTT Next Generation IP-PBX System

Simultaneous PTT and VoIP Call

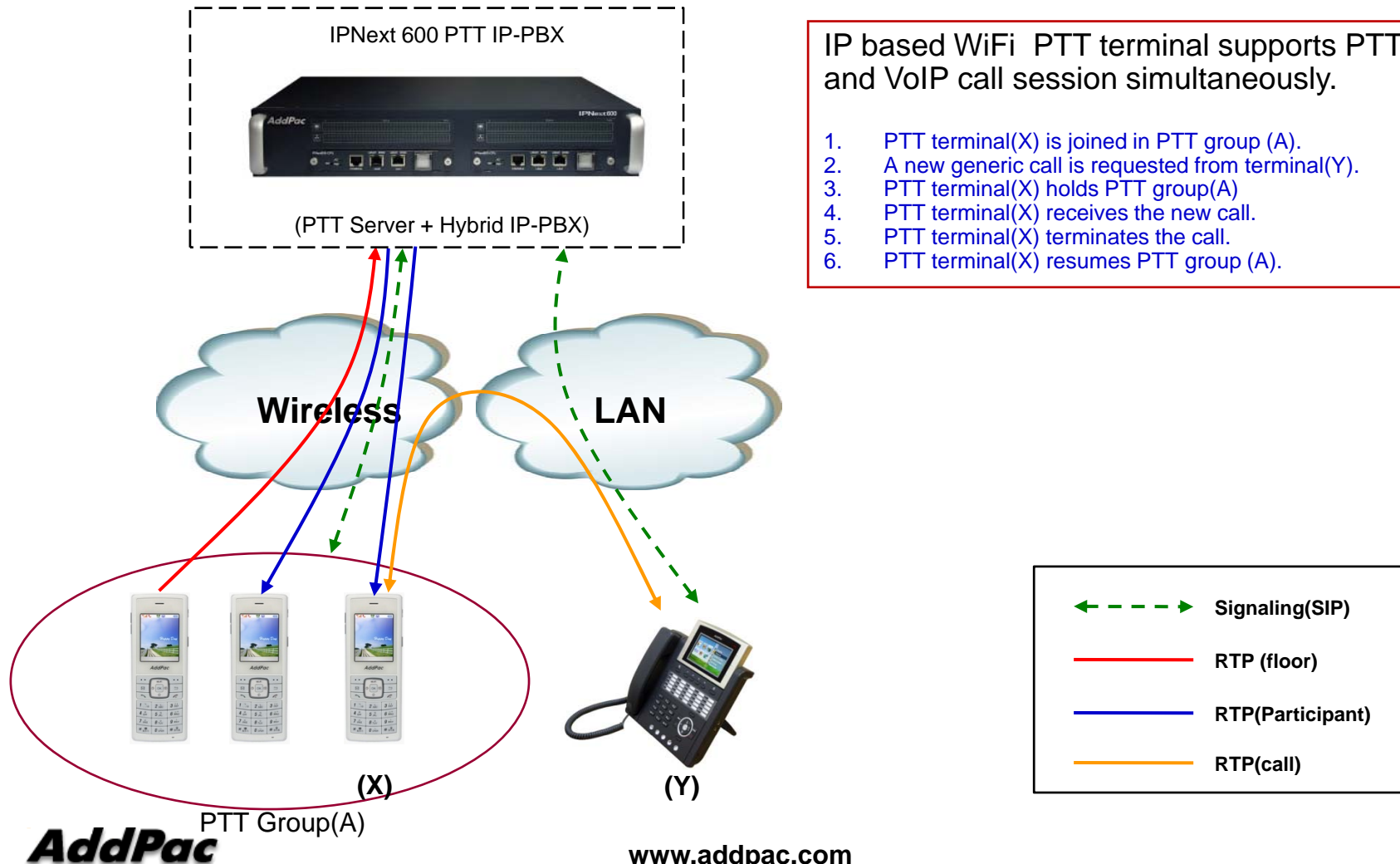

IP based WiFi PTT terminal supports PTT and VoIP call session simultaneously.

1. PTT terminal(X) is joined in PTT group (A).
2. A new generic call is requested from terminal(Y).
3. PTT terminal(X) holds PTT group(A)
4. PTT terminal(X) receives the new call.
5. PTT terminal(X) terminates the call.
6. PTT terminal(X) resumes PTT group (A).

IP based PTT Call Service Examples(3/3)

IPNext600 PTT Next Generation IP-PBX System

Emergency PTT

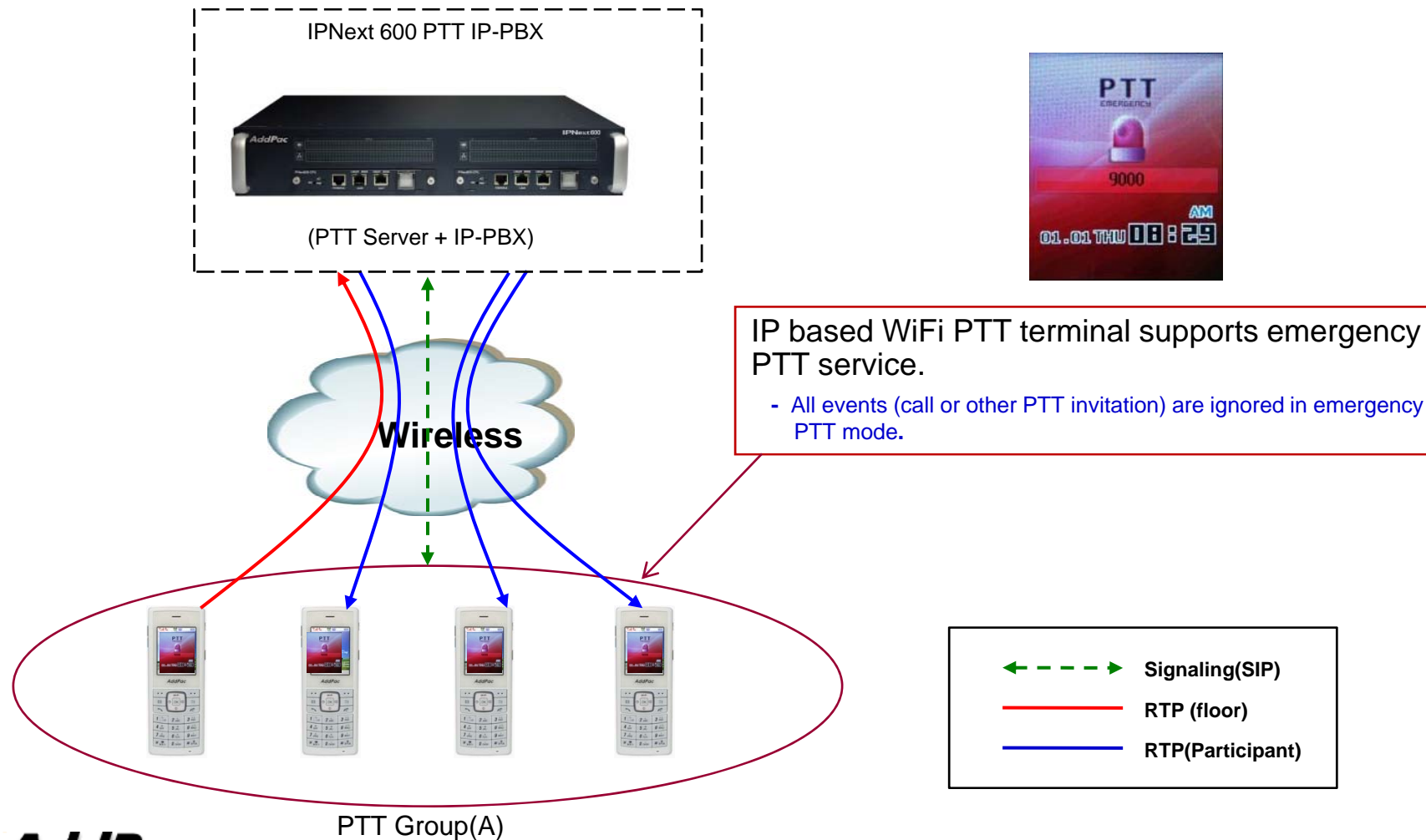

SMM for PTT (User Friendly Management)

IPNext600 PTT Next Generation IP-PBX System

Easy Configuration Tool Support

Group Properties

General Participants

Group Name: Push-to-Talk#8000-NightGuards

Description: Push-to-Talk conference session for night guards

Number: 4050

Partition: N/A Edit

Audio Codec Class: default Edit

Group Priority: 3 (Zero is high priority)

Max Session Idle Time: 60 seconds

Max Floor Hold Time: 30 seconds

Close on Chair Out

Ok Cancel

Easy Drag and Drop Configuration

Group Properties

General Participants

Filter

Filter Name: Phone Number Rule: begins with Word: Advanced Search Find

Number	Partition	User
1000		
1018		bd seong
2000		
2010		
2011		
2012		
2013		
2014		
2015		

Enter External Phone Number

Add

Number	Partition	User	Type
2010			Internal
2014			Internal

Ok Cancel

Easy PTT Session Creation & Various Option Support

SMM for PTT (Active PTT Session Monitoring)

IPNext600 PTT Next Generation IP-PBX System

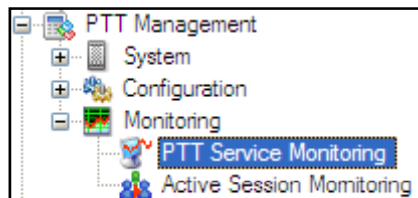

You can monitor the current resource usage of PTT servers through this window.

The 'System Monitoring - PTT Server' window displays resource usage for the IPNext180_TEST server (172.16.12.99). It features four monitoring panels: 'PTT Session' (graph 1), 'Active PTT Session History' (grid), 'Participant' (graph 2), and 'Active Participant History' (grid).

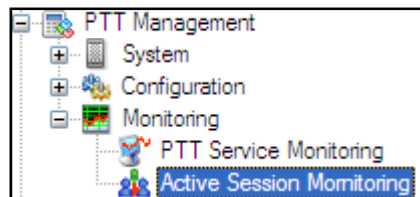

You can monitor the list of active PTT sessions and participants information of the sessions.

The 'PTT Active Session Monitoring' window for IP 172.16.12.99 displays the following data:

Sessions				
Name	Number	Start Time	Duration	No. of Participant
Conference #1000	1212	20100101-17:48:59	00:01:15	2

Participants			
Participant Name	Phone Number	IP	Status
kn kim	7000	172.16.50.123	Joined
bd seong	1018	172.16.253.117	Joined

Standard PTT IP-PBX System Application

IPNext600 PTT Next Generation IP-PBX System

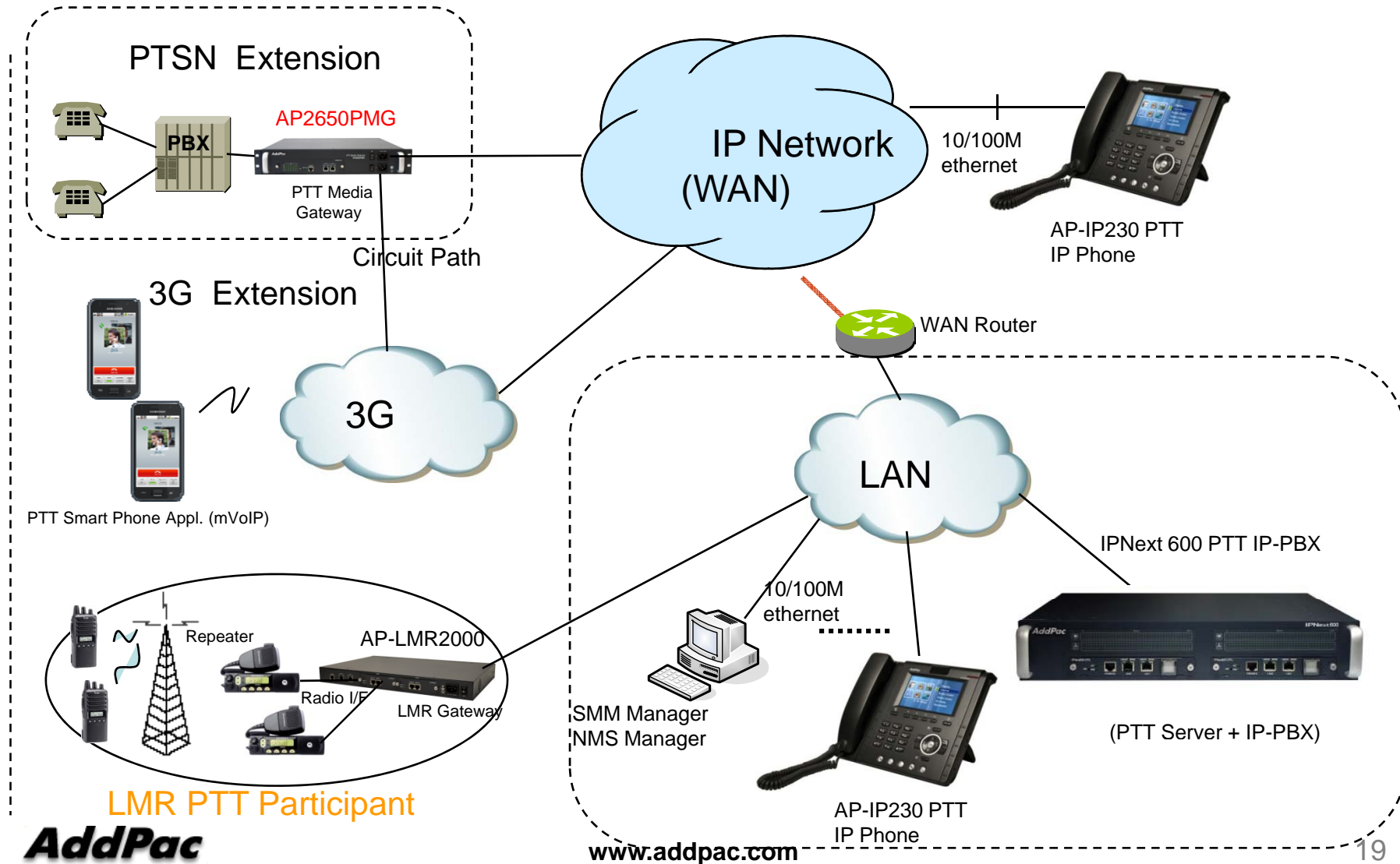



Thank you!

AddPac Technology Co., Ltd.
Sales and Marketing

Phone +82.2.568.3848 (KOREA)

FAX +82.2.568.3847 (KOREA)

E-mail sales@addpac.com



AP2610

Analog VoIP Gateway

Product Overview

AP2610 VoIP Gateway

- High Performance Analog VoIP Gateway Solution
- H.323/SIP Dual Concurrent Stack Embedded
- High Performance RISC & Programmable DSP Architecture
- Two(2) 10/100Mbps Fast Ethernet (IP Share, etc)
- High Performance LAN-to-LAN Routing Capability
- G.711/G.726/G.723/G.729, T.38 Fax , VAD, etc
- Powerful Network Protocols (PPPoE, DHCP, Static Routing, etc)
- Firmware Upgradeable Architecture
- Smart NMS for Large Scale Deployment
- Advanced Voice QoS Mechanism
- Light and Compact Design with Internal Power Supply
- One(1) VoIP Module Slot

Hardware Specification

AP2610 VoIP Gateway

RISC
CPU

High-end
DSP

- RISC Microprocessor Computing Power
- Up to 4-Port Analog VoIP Gateway
- Two(2) VoIP Module Slots (Hot-Swap)
 - 4-Port FXS Card, 4-Port FXO Card, 4-Port E&M Card
- Network Interface
 - Two(2) 10/100Mbps Fast Ethernet (RJ45)
- RS232C Console Interface
- Run LED, LAN LED, Port LEDs
- Internal Power Supply

Hardware Specification

AP2610 VoIP Gateway

AP2610 VoIP Series	Basic Specifications
Voice Interface	One(1) VoIP Module Slot
	AP-FXS4, AP-FXO4, AP-E&M4, etc
Ethernet Interface	2-Ports 10/100Mbps Ethernet Interface(RJ-45)
Flash Memory	4Mbyte High-speed Flash Memory
Base Memory	32 Mbyte High-speed SDRAM
Power Requirement	Power Supply Adaptor / VAC 110~220V, 50/60Hz,
Operating Temperature	0°C ~ 45°C (32 °F ~ 122°F)
Storage Temperature	-40°C ~ 85°C (-40°C ~ 185°F)
Relative Humidity	5% ~ 95% (Non-condensing)
Dimension (H x W x D)	43mm x222mm x 332mm
Weight(kg)	2.2Kg

Hardware Specification

AP2610 VoIP Gateway

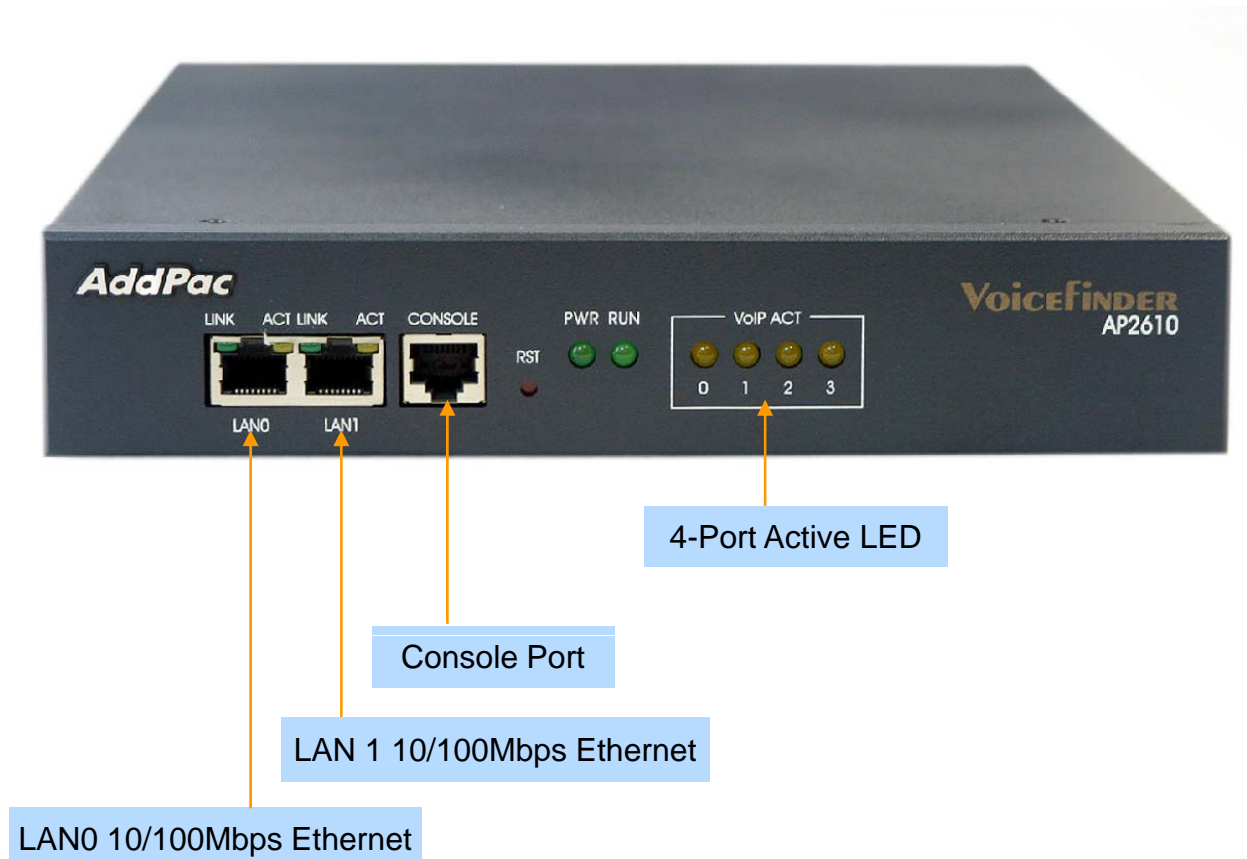



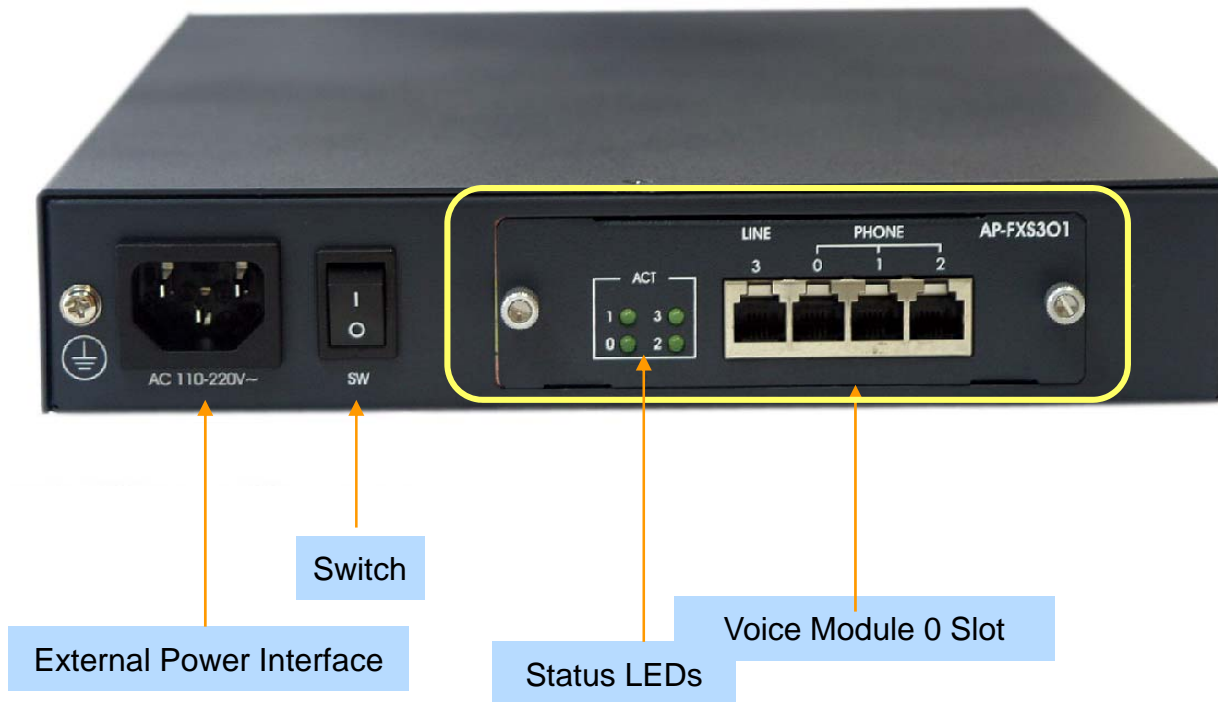

Hardware Specification

AP2610 VoIP Gateway



VoIP Modules

DSP

Target	VoIP Modules	Module Features	Module Picture
AP2610	AP-FXS4	4-Port FXS Module	
AP2610	AP-FXO4	4-Port FXO Module	
AP2610	AP-FXS2O2	2-Port FXS&2-Port FXO Module	
AP2610	AP-E&M4	4-Port E&M Module	
AP2610	AP-FXS3O1	3-Port FXS&1-Port FXO Module	



Thank you!

AddPac Technology Co., Ltd.
Sales and Marketing

Phone +82.2.568.3848 (KOREA)

FAX +82.2.568.3847 (KOREA)

E-mail sales@addpac.com