



VoIP

AP2610

4 Port VoIP Gateway



Technical Sales and Marketing

AddPac Technology

www.addpac.com

AP2610 VoIP Gateway Product Overview

APOS Internetworking Protocol Stack

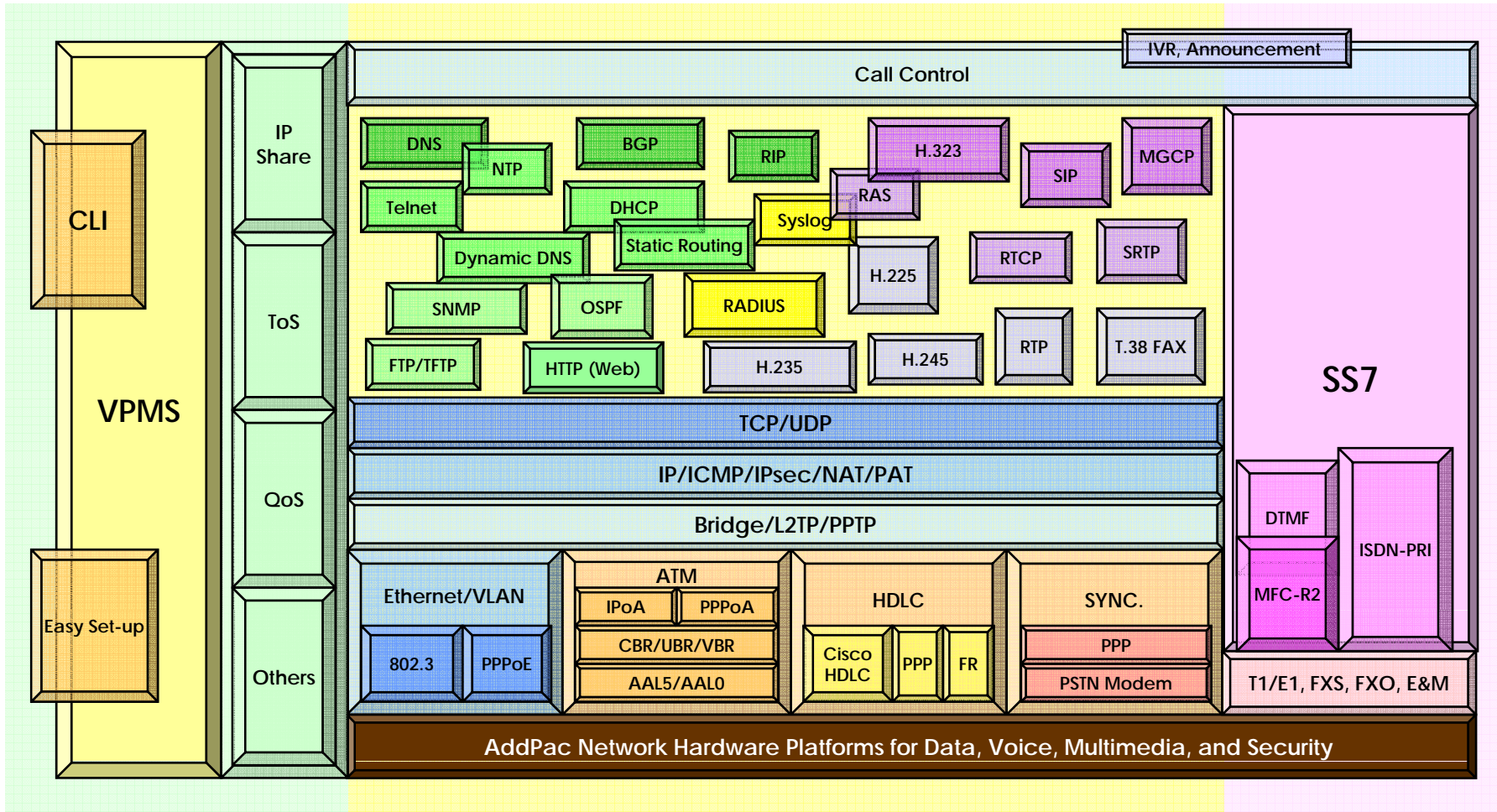

AP2610 VoIP Gateway Product Overview

APOS Internetworking S/W World

• APOS Internetworking Software World

- AddPac Operating System (APOS)
- Support Industry Standard
- Integrated Networking Protocols
- Optimized Performance & Functionality
- Easy to use, Installation, and Maintenance

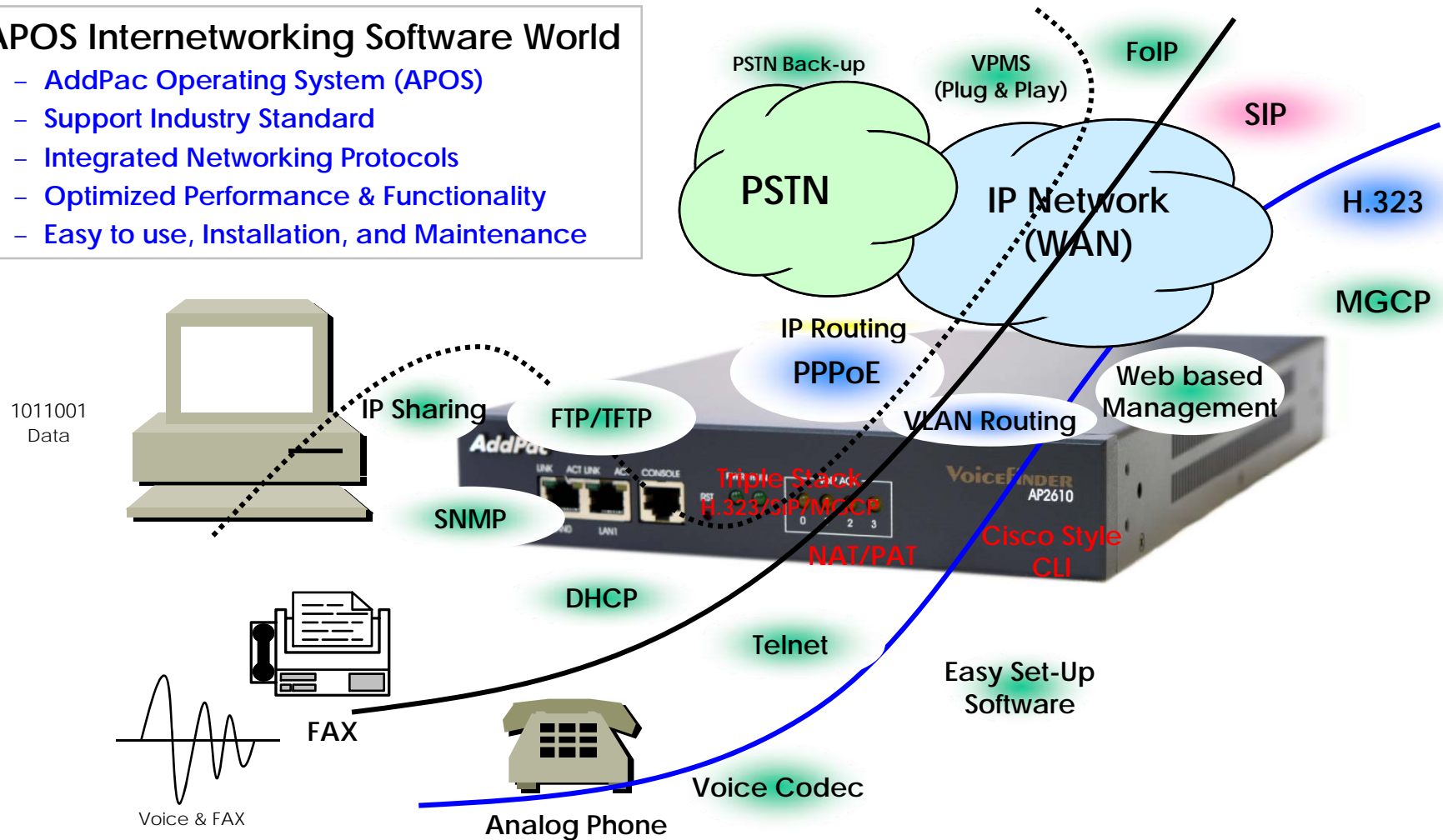

AddPac

www.addpac.com

AP2610 VoIP Gateway Product Overview

APOS Internetworking S/W World (cont.)

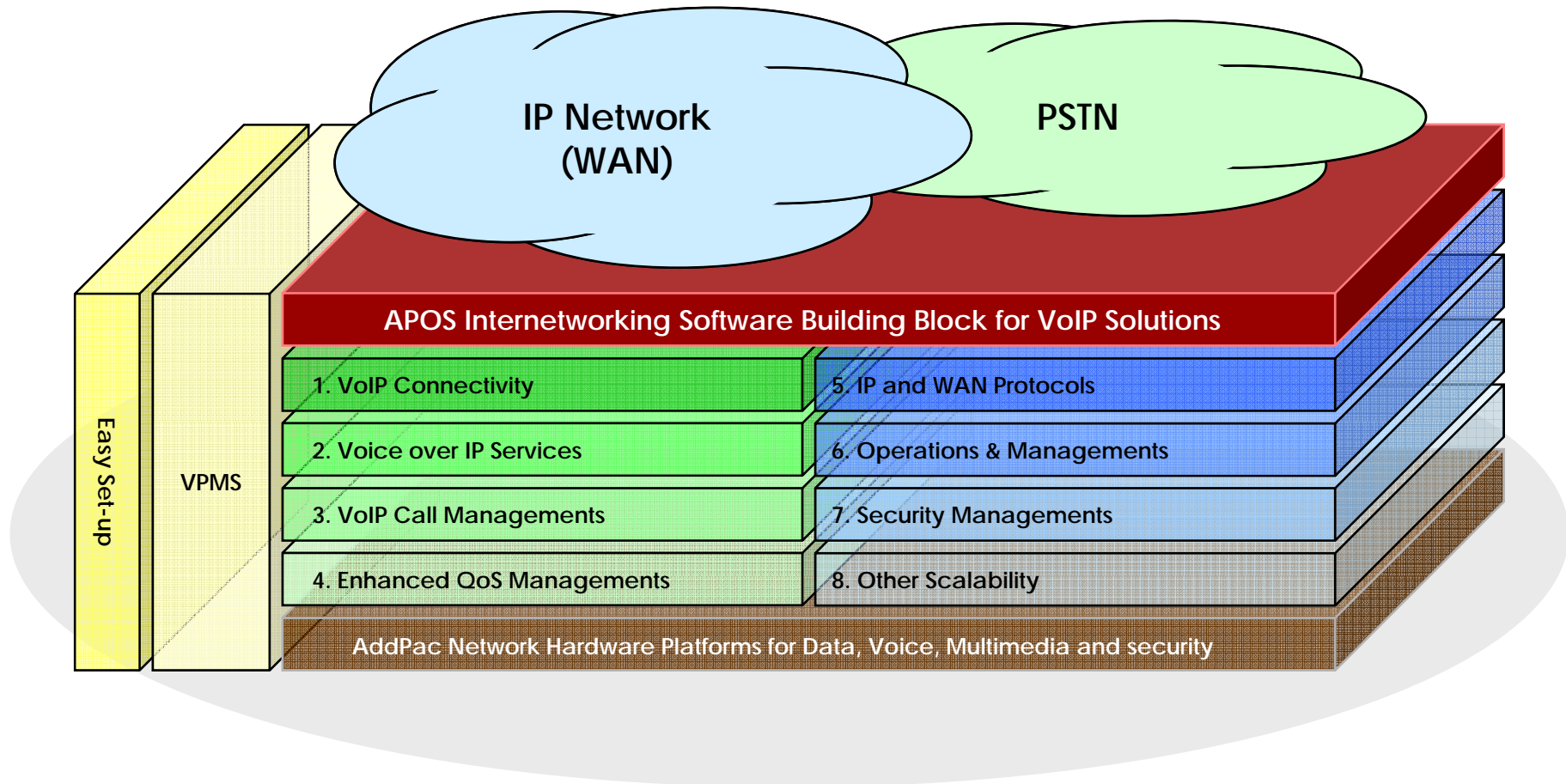

AP2610 VoIP Gateway Product Overview

VoIP Gateway Connectivity

• FXS

- RJ-11 Hardware interface
- Polarity inverse generation function
- Caller-id generation function
- Busy-out function support
- Ring cadence setting function
- Ring frequency setting function
- European type II telephone support
- Surge protect support

• FXO

- RJ-11 Hardware interface
- Polarity inverse detection function
- Caller-ID detection function
- Busy-out function support
- PSTN backup or busy-out function with Hook off in case of power down
- Clear down tone registration and detect function
- Hook flash timing setting function
- Ring detect timeout setting function
- Ring number setting function
- For outbound calls, connect when voice is detected

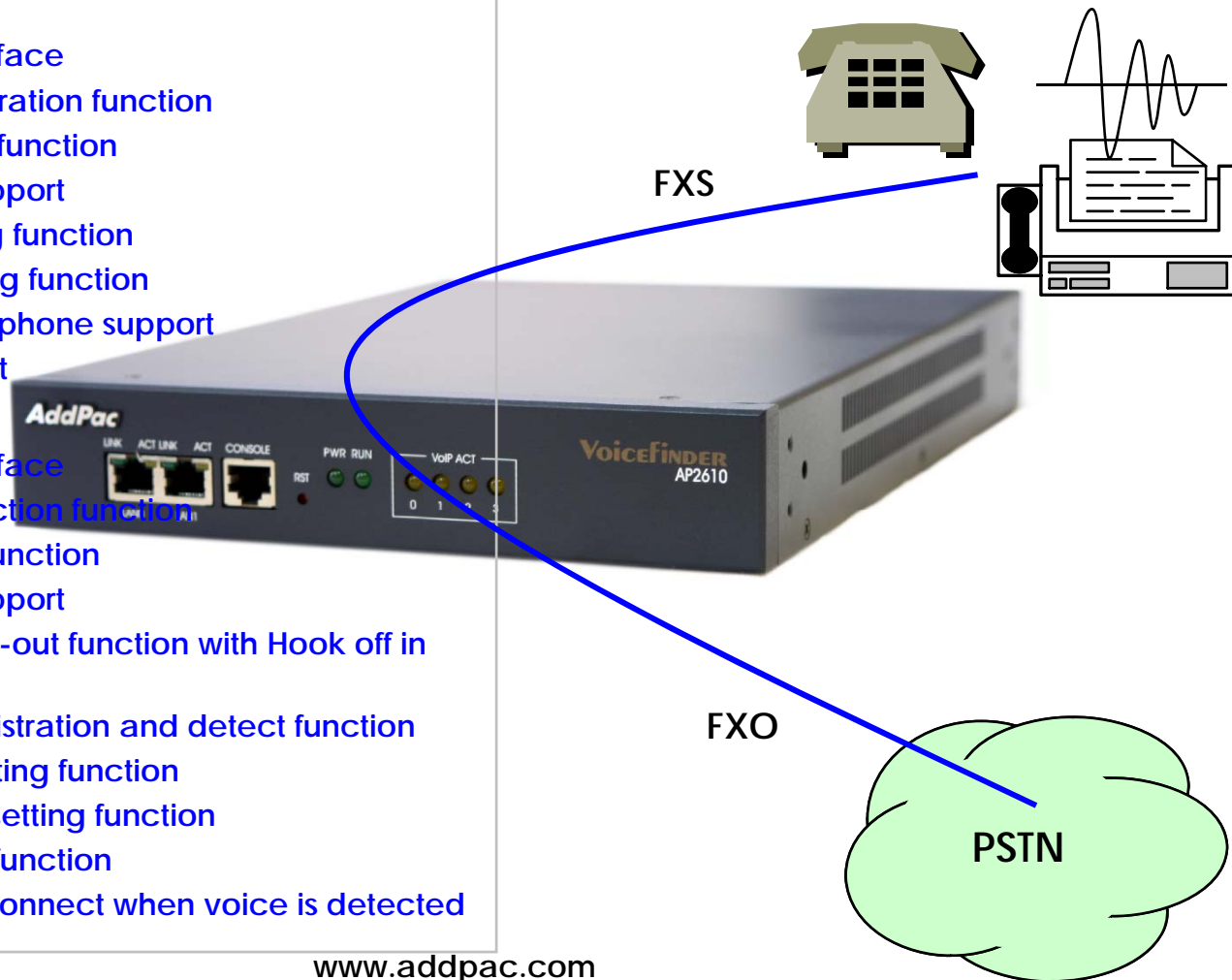

AP2610 VoIP Gateway Product Overview

VoIP Gateway Connectivity

- E&M

- Type 1, 2, 3, 5 support
- 2-wire, 4-wire support
- Delay-dial, Immediate, Wink-wait signaling support
- Dialout-delay, Delay-duration, Delay-start, Wait-wink, Wink-duration, Wink-wait timing setting support

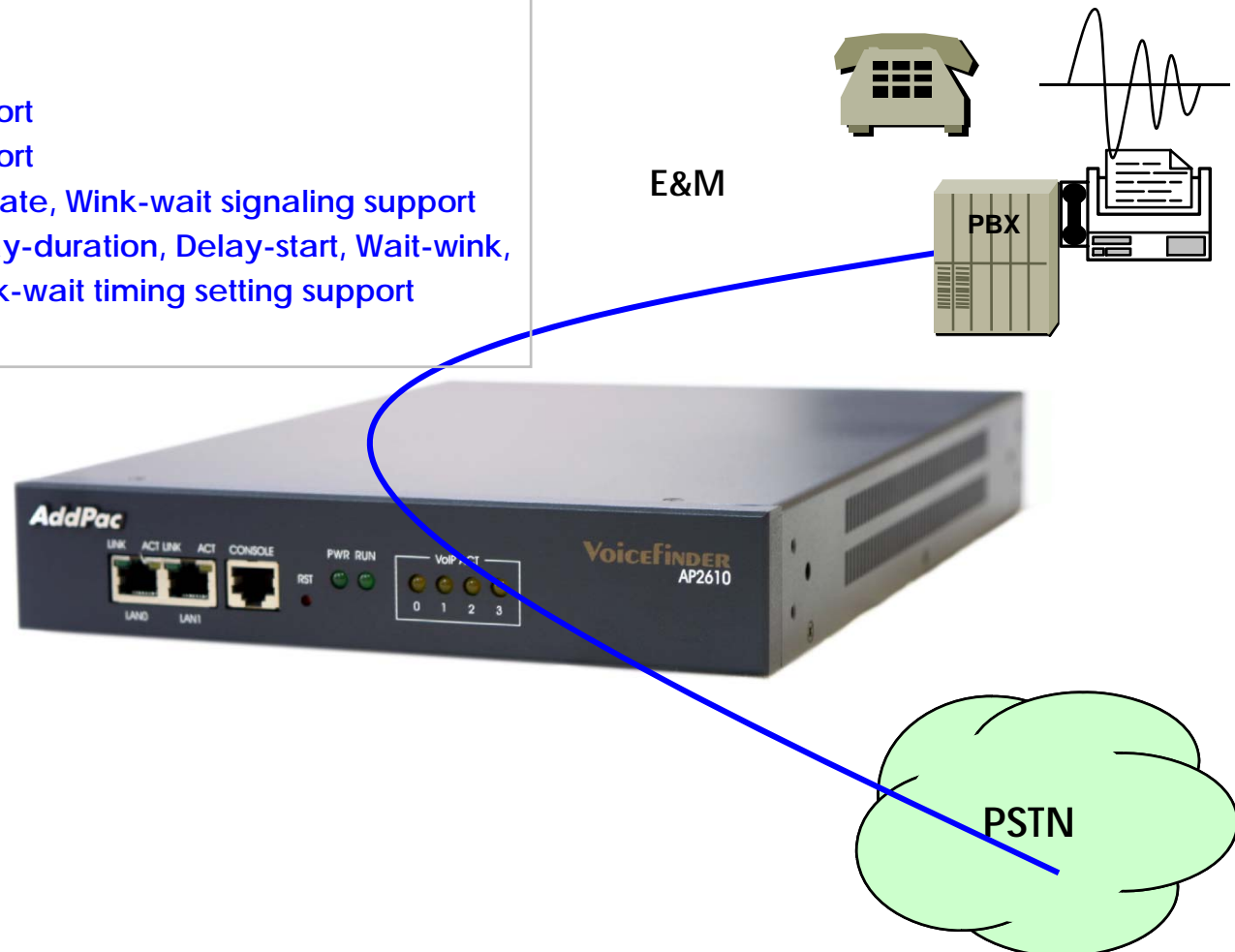

AP2610 VoIP Gateway Product Overview

Voice over IP Service

- H.323, SIP, and MGCP Triple Stack
 - Concurrent Triple VoIP Stack Software
 - Single Hardware with Three VoIP Service
 - New APOS-NX Version
- H.323
 - ITU-T Standard H.323 v3 Support
 - Support H.245 Tunneling
 - Including H.235 Security Features
- SIP
 - IETF RFC3261 or RFC2543 SIP Standard
- MGCP
 - IETF RFC2705bis-02 Standard MGCP 1.0

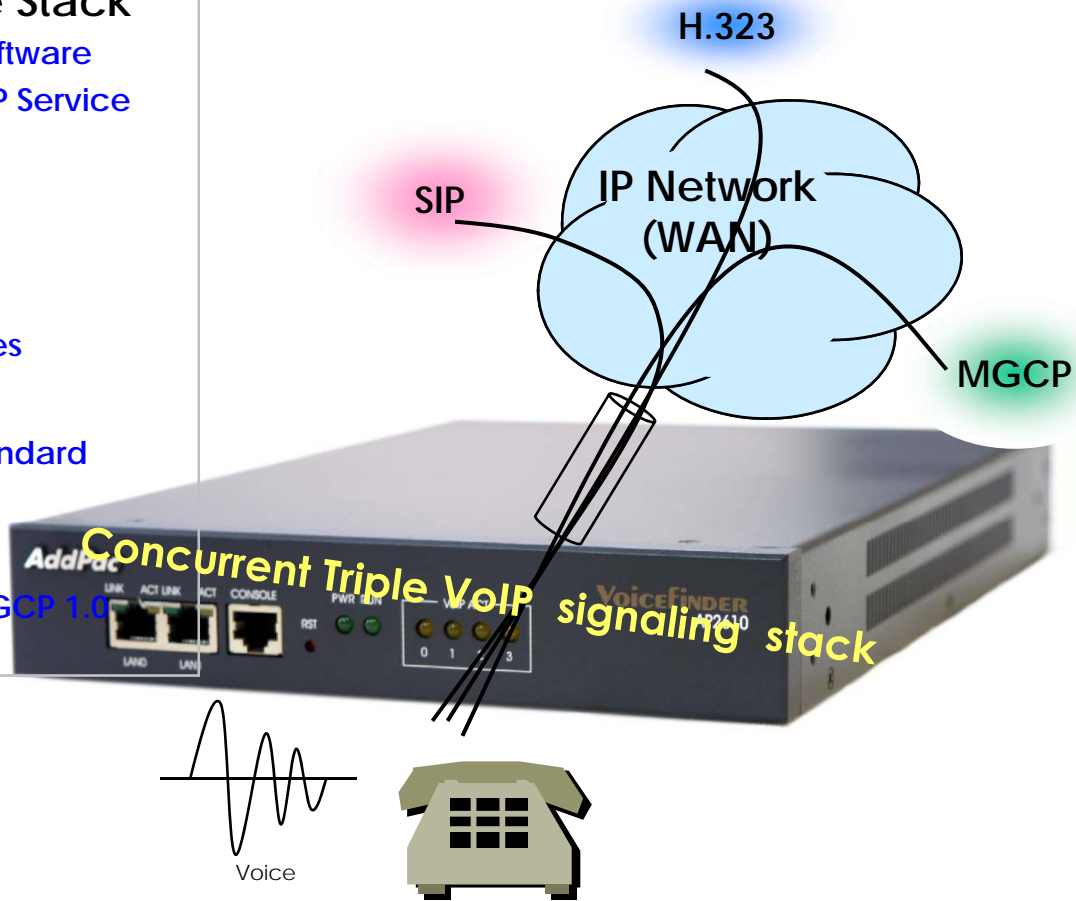

AP2610 VoIP Gateway Product Overview

Voice over IP Service (cont.)

• H.323

- Fast connect, normal connect support
- H.245 tunneling support
- Q.931 response message setting for inbound VoIP calls
- H.245 logical channel open timing selection function
- Start H.245 procedure support
- DTMF / Hook flash relay with H.245 alphanumeric / signal
- Secondary gatekeeper support
- Gatekeeper assignment according to the domain name
- Gatekeeper discovery with multicast
- Lightweight RRQ support
- Signaling TCP port assignment
- Resource threshold setting with RAI
- H.235 clear-token, crypto-token support
- canMapAlias support
- Technical prefix (supported prefix) support
- Public IP assignment in NAT environment

• SIP

- Gateway-based / Endpoint-based registration support
- Secondary proxy-server assignment function
- SIP signaling port change function
- SIP proxy server assignment according to the domain name
- T.38 real-time fax relay support
- DTMF relay support with RFC2833 / OPTION message
- Re-INVITE support
- Secondary call agent assignment function
- Default package assignment
- Announcement Server Package, Generic Media Package, Handset Package, Line Package, Trunk Package support
- MGCP call agent assignment according to the domain name
- T.38 real-time fax relay support
- DTMF relay support based on RFC2833



AP2610 VoIP Gateway Product Overview

Voice over IP Service (cont.)

• Voice Codec

- G.711 A-Law, G.711 U-Law
- G.726 r16, G.726 r32
- G.729A
- G.723.1 r63, G.723.1 r53
- VAD (Voice Activity Detection) function support
- DTMF relay support (H.323, SIP, MGCP common) based on RFC2833

• RTP

- Redundant RTP packet transmission in case of severe packet loss
- Dynamic jitter buffer management and RPT packet jitter and loss compensation with heuristic & DSP error concealment
- Static jitter buffer setting support
- Voice frame per RTP packet number control for each codec
- In-band ring-back tone support
- Virtual ring-back tone support
- Tone parameter change support

• FAX

- Fax relay mode supporting T.38, inband-T.38, bypass mode
- Lost packet compensation with redundant setting in case of T.38 fax relay
- Fax relay mode, rate setting for remote end

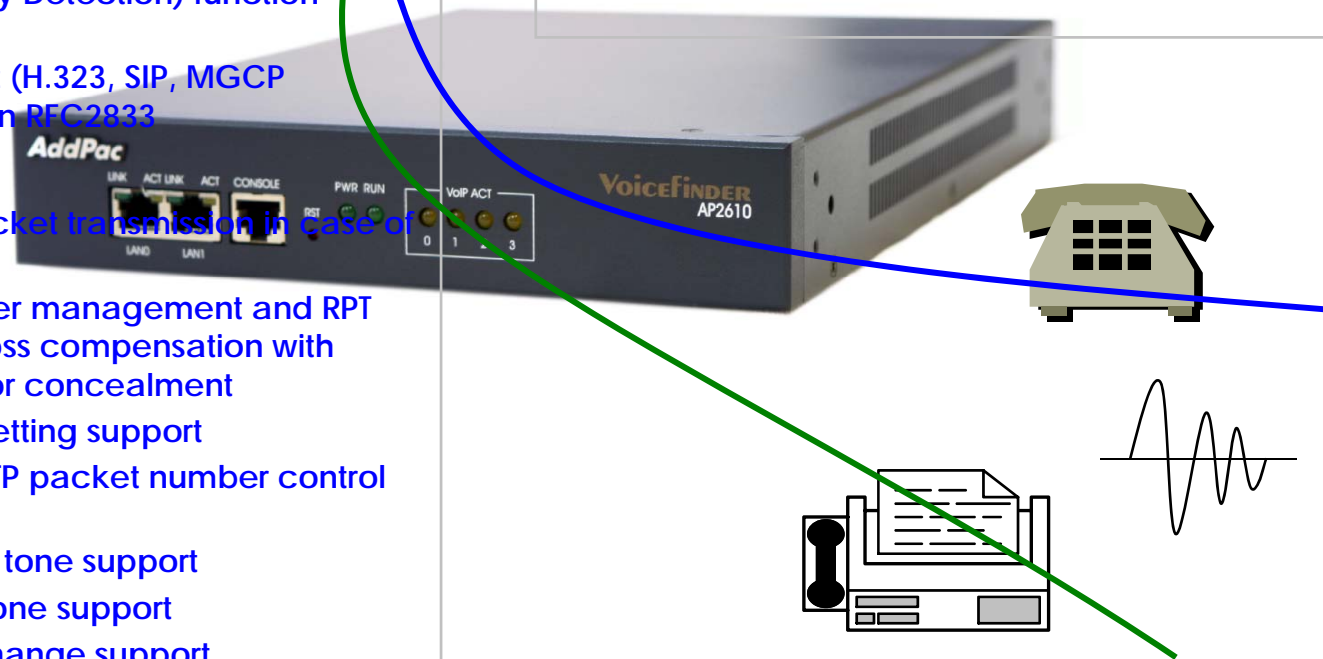

AP2610 VoIP Gateway Product Overview

VoIP Call Managements

• VoIP Call Controls

- Hot line connection function with PLAR (Private Line Auto Ring Down)
- Leased line emulation function
- Connection monitoring function
- Fault tolerant with Redundancy and Call Distribution among Gateways for load balancing
- Call attempt with IP address
- H.323, SIP, MGCP inbound call connection for each voice port
- Multiple E.164 setting for one voice port
- One E.164 or digit pattern can be assigned to more than one voice port
- Hunting with Longest match/ priority/ sequence/ random
- One stage call setup by Digit forwarding
- Call barring with specific digit patterns
- Calling and called number conversion for PSTN outbound calls
- PSTN rerouting in case of VoIP call attempt failure

• VoIP Call Controls (cont.)

- Call transfer for internal calls
- Call pickup for internal calls
- Calling and called number conversion for VoIP outbound calls
- Calling and called number conversion for VoIP inbound calls
- Fax broadcasting call control

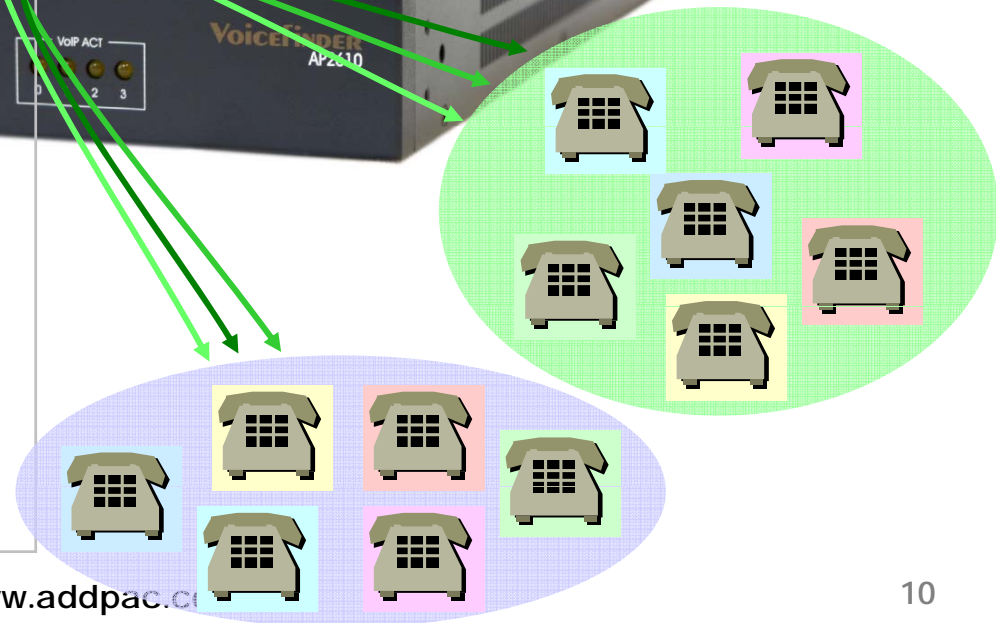

AP2610 VoIP Gateway Product Overview

Enhances QoS Managements

- Enhances **Transmit** Voice QoS Features

- Voice Traffic Priority Queuing
- QoS Service Profiling
- Providing Virtual Network Transmit Algorithm
- Real-time Voice Traffic QoS Support
- RTP Packet Transmit Interval Control
- Supporting RTP Packet Redundancy Scheme
- IP Header Control such as ToS, Diffserv

- Enhances **Receive** Voice QoS Features

- Dynamic Jitter Buffer Management
- Error Concealment
- Support T.38 FAX Data Error Recovery Scheme

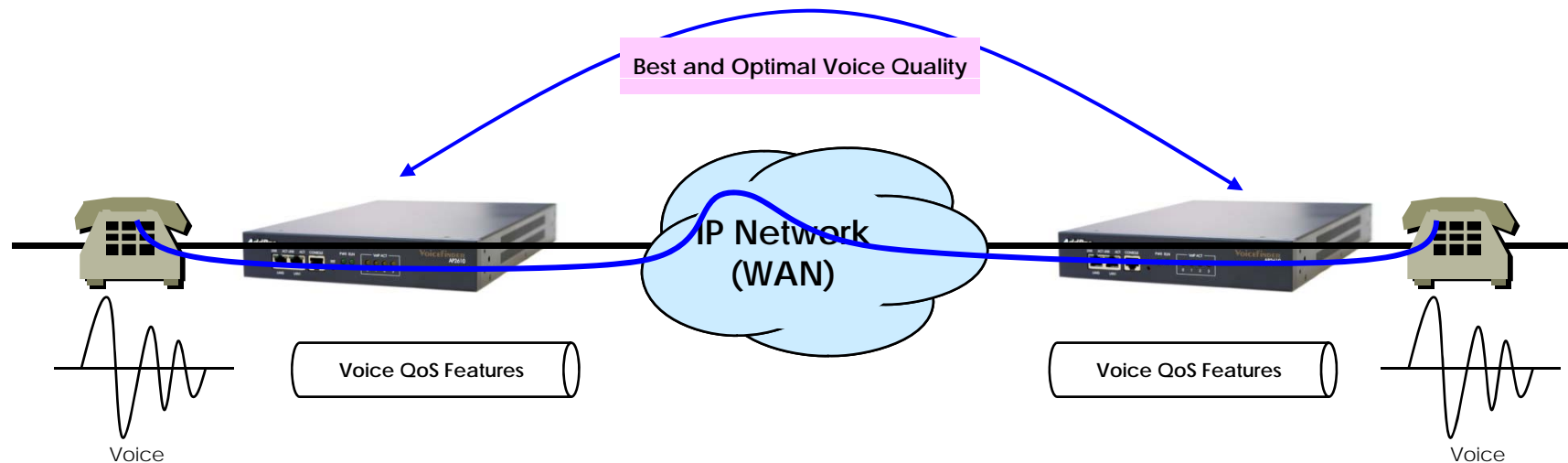

AP2610 VoIP Gateway Product Overview

IP and WAN Protocols

- IP Routing Protocols

- Multi-protocol Internetworking Services
- Static IP routing
- RIP v1/v2 (opt.)
- OSPF v2 routing protocols support (opt.)
- Transparent Bridging (IEEE Spanning Tree Protocol)

- WAN Protocols

- Point-to-Point Protocol (PPP)
- High-level Data Link Control (HDLC) Protocol

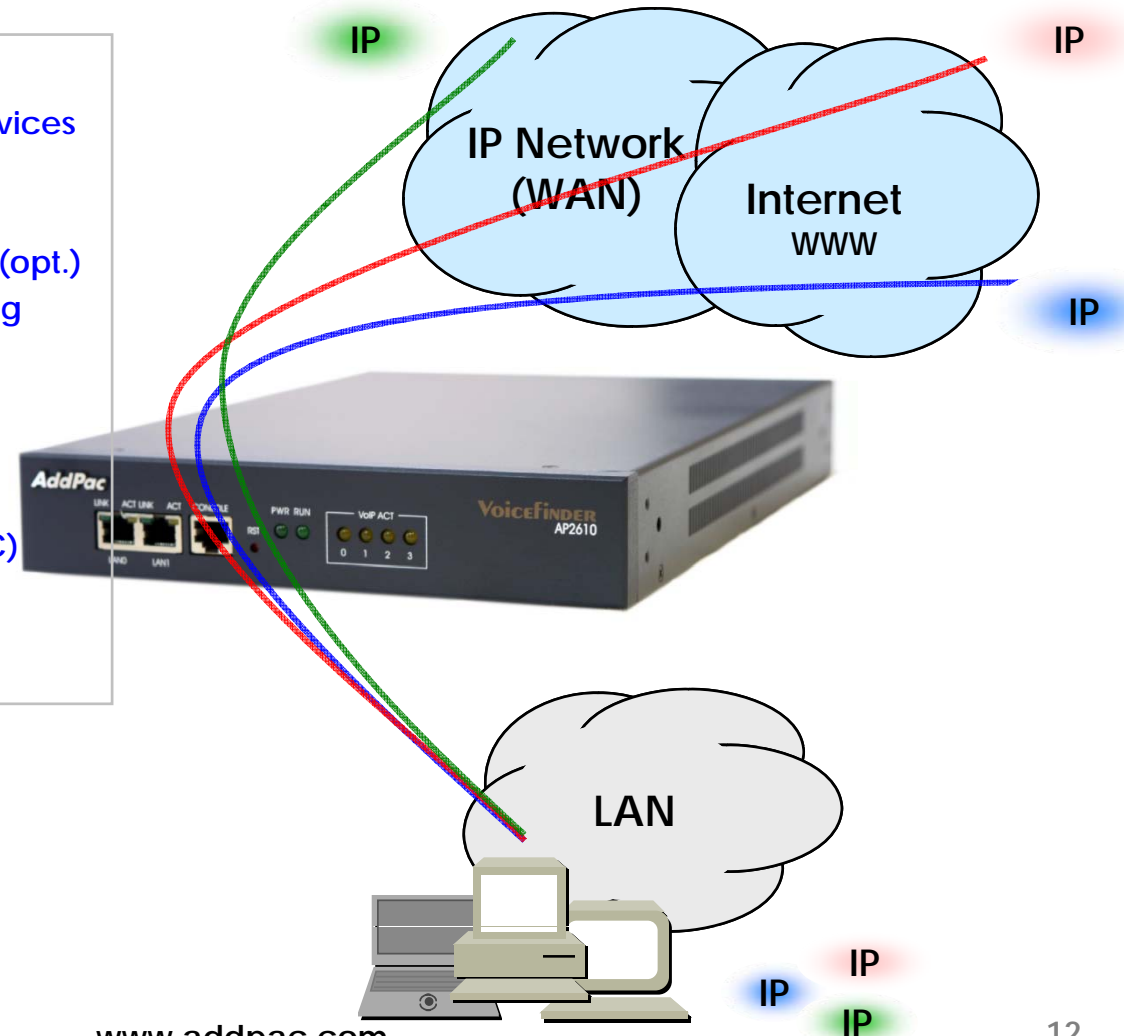

AP2610 VoIP Gateway Product Overview

Network Managements

- **SNMP**

- Standard Simple Network Management Protocol (SNMP) Agent support
- MIB v1 and v2 Support

- **Web-based Management**

- Standard Voice Interface
- Standard PSTN Back-up Interface

- **Watch-dog Function**

- Hardware, Software watch-dog services

- **Remote Management**

- Telnet
- Rlogin
- Console

- **Auto Upgrade Service**

- HTTP server based APOS image and configuration file auto-upgrade support

- **Batch Job Function**

- Text based script downloading

- **Easy Set-up Service**

- MS Windows Graphical User Interface (GUI) based installation Software Solution
- Easy installation Set-up service

- **Interoperable with AP-VPMS Service**

- AddPac VoIP Plug & Play Management System (AP-VPMS)

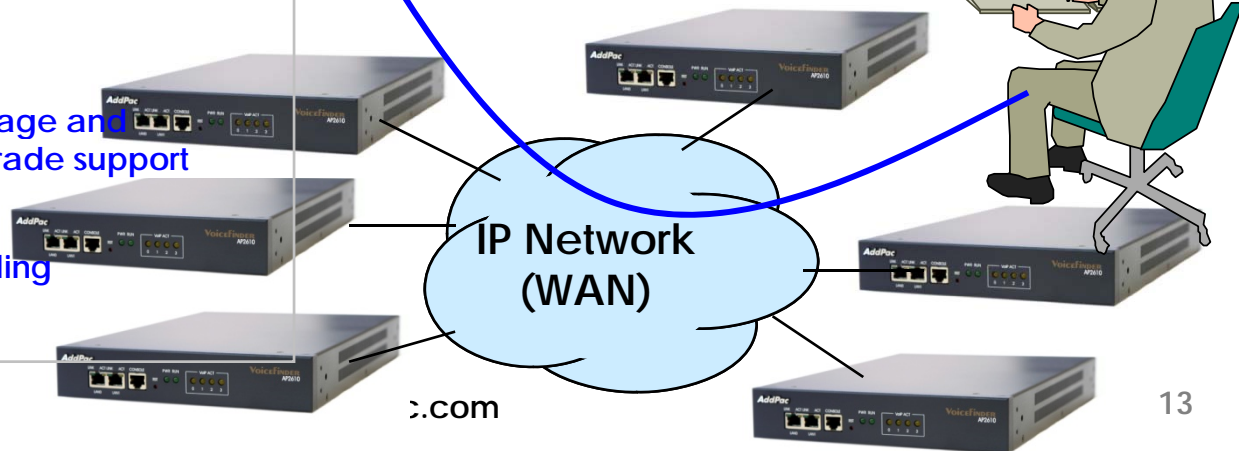

AP2610 VoIP Gateway Product Overview

Security Managements

- IP packet filtering
- IP access list
- User authentication function
 - Password Authentication Protocol (PAP)
 - Challenge Handshake Authentication Protocol (CHAP)
- Enable/Disable specific protocols
- Auto-square connect of console and Telnet session
- Account Management function for multi-level user
- SNMP/TELNET/FTP/HTTP/TFTP port assignment function
- SNMP/TELNET/FTP access list management
- Boot mode security checking function

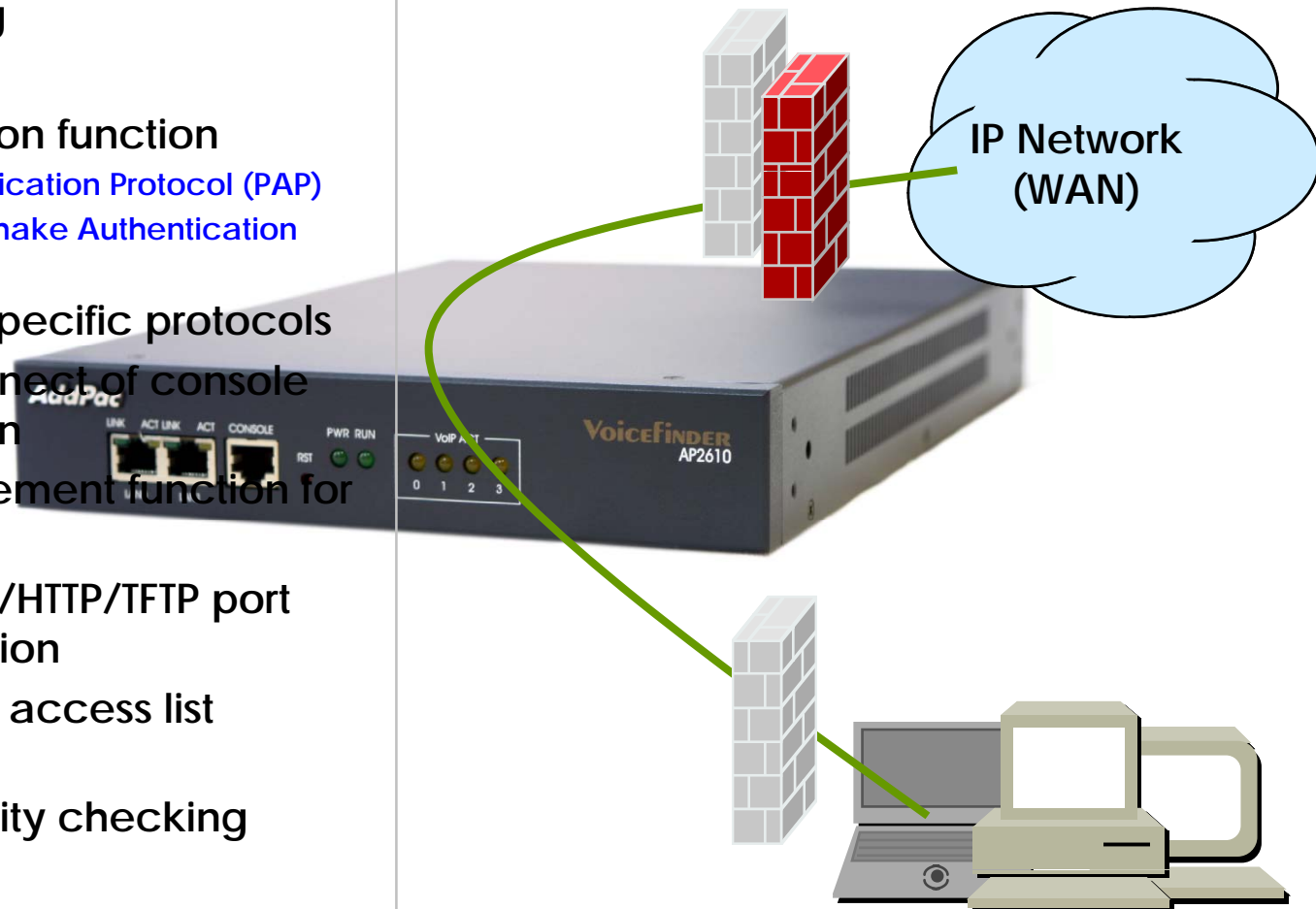

AP2610 VoIP Gateway Product Overview

Network Scalability

- IP Sharing Feature
 - Single IP Address, Multiple IP Network Access
 - Public IP Address Sharing by VoIP Gateway
- IP Sharing Network Environment
 - Support Legacy Network Environment
 - xDSL Modem based Broadband Network
 - Cable Modem based Broadband Network
 - Leased line Network Environment
- Both support Fixed and Dynamic IP
- Support Standard Network Protocols
 - PPPoE
 - PPPTP
 - DHCP

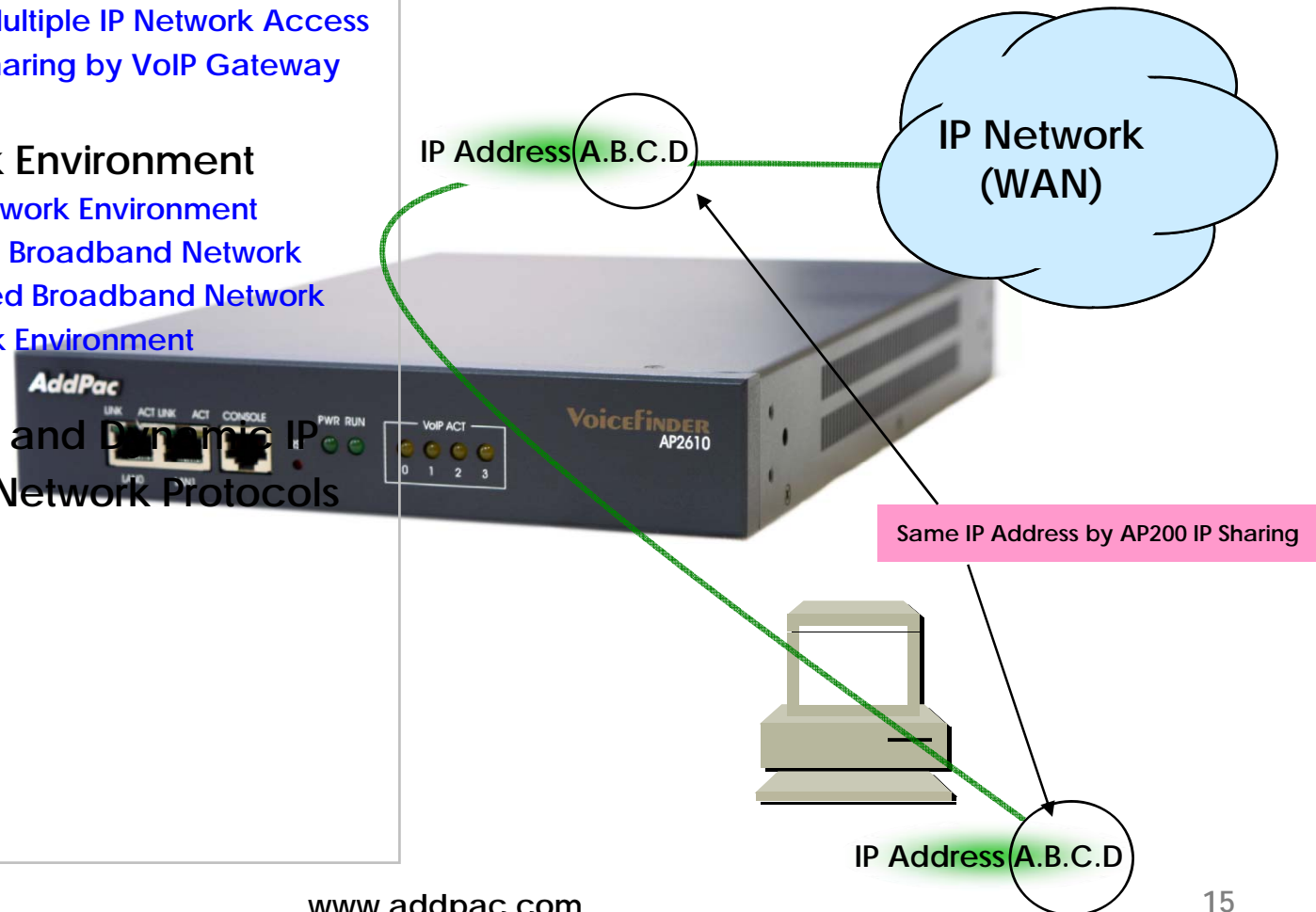

AP2610 VoIP Gateway Product Overview

Network Scalability (cont.)

- Bridging Service
 - Spanning Tree Bridging protocol (IEEE) support
- DHCP
 - Server and Relay
- IP Accounting
- PAT (Port Address Translation)
- NAT (Network Address Translation)
- Cisco Style CLI (Command Line Interface)
- PPTP (Point-to-Point Tunneling Protocol)
- NTP (Network Time Protocol)
- FTP/TFTP
 - Server and Client support
- DNS
 - Dynamic DNS Client support

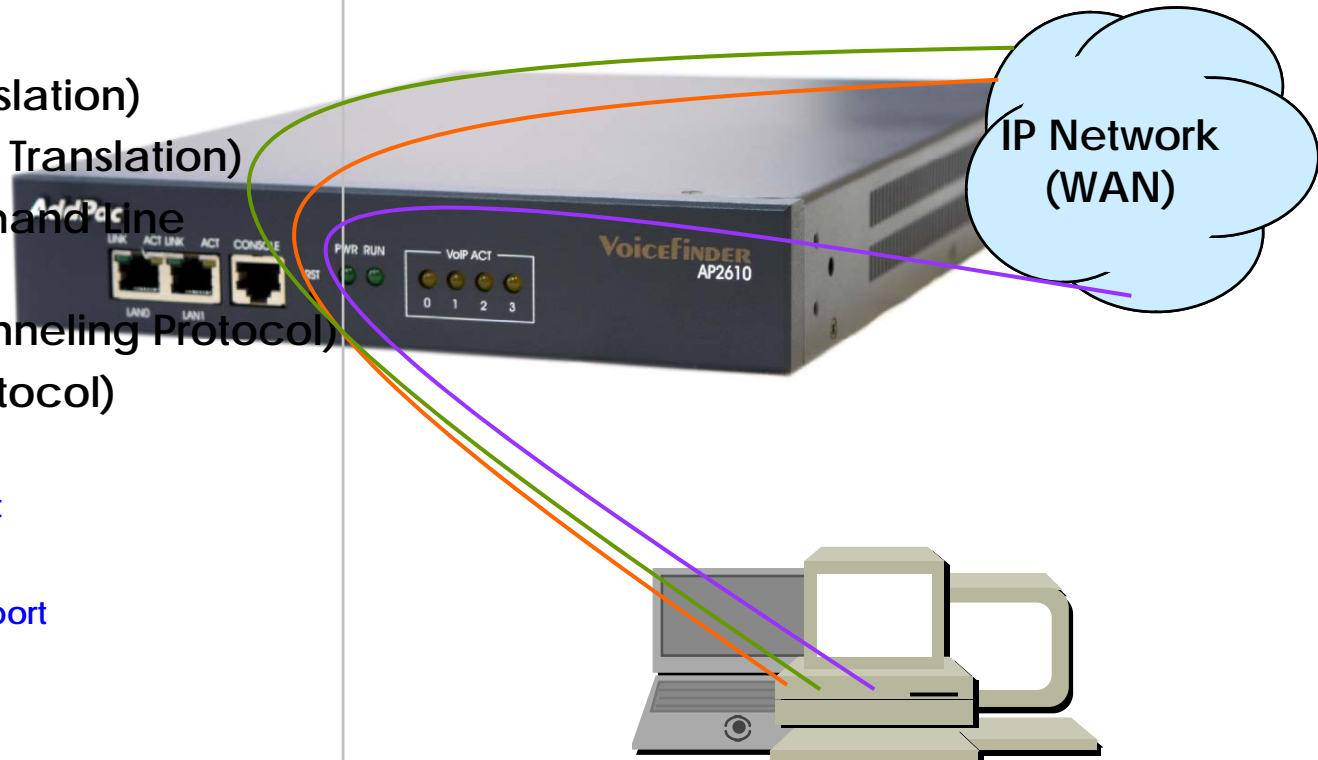

AP2610 VoIP Gateway Product Overview

VoIP Plug & Play System (VPMS)

- AddPac AP-VPMS Support
 - AddPac VoIP Plug & Play System (VPMS)
 - Best EMS Solutions for AddPac VoIP G/W
- Requirements Hardware Platform
 - Over 1GHz Intel Pentium 4 Machine
 - Over 1GB Main Memory
 - Over 40GB Hard Disk Memory
 - Microsoft Windows Advanced Server or Windows 2000 Server or Windows XP Professional
 - DBMS : Microsoft MS-SQL Server 2000

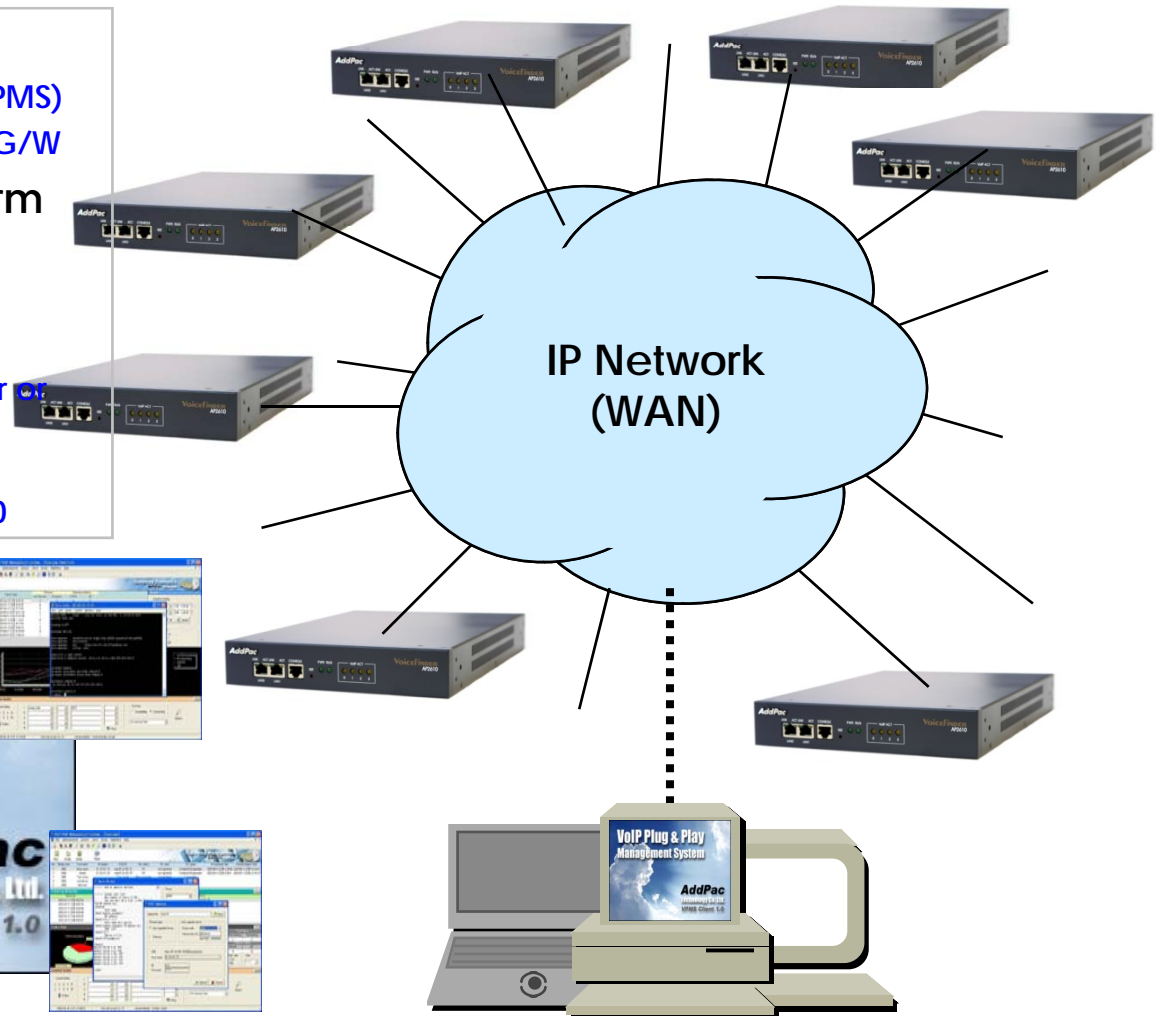

AP2610 VoIP Gateway Product Overview

AP2610 Network Interface

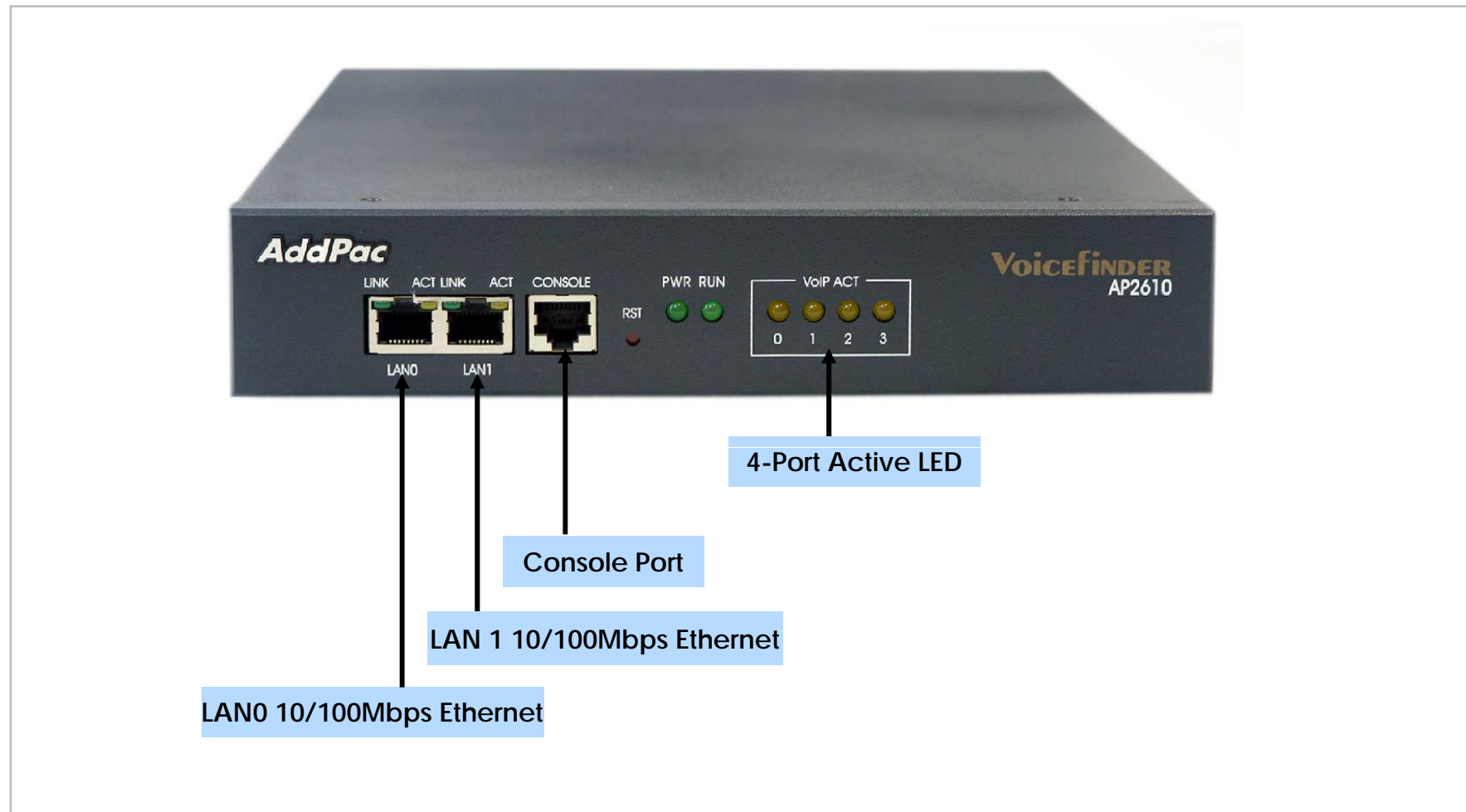

AP2610 VoIP Gateway Product Overview

AP2610 Hardware Specification

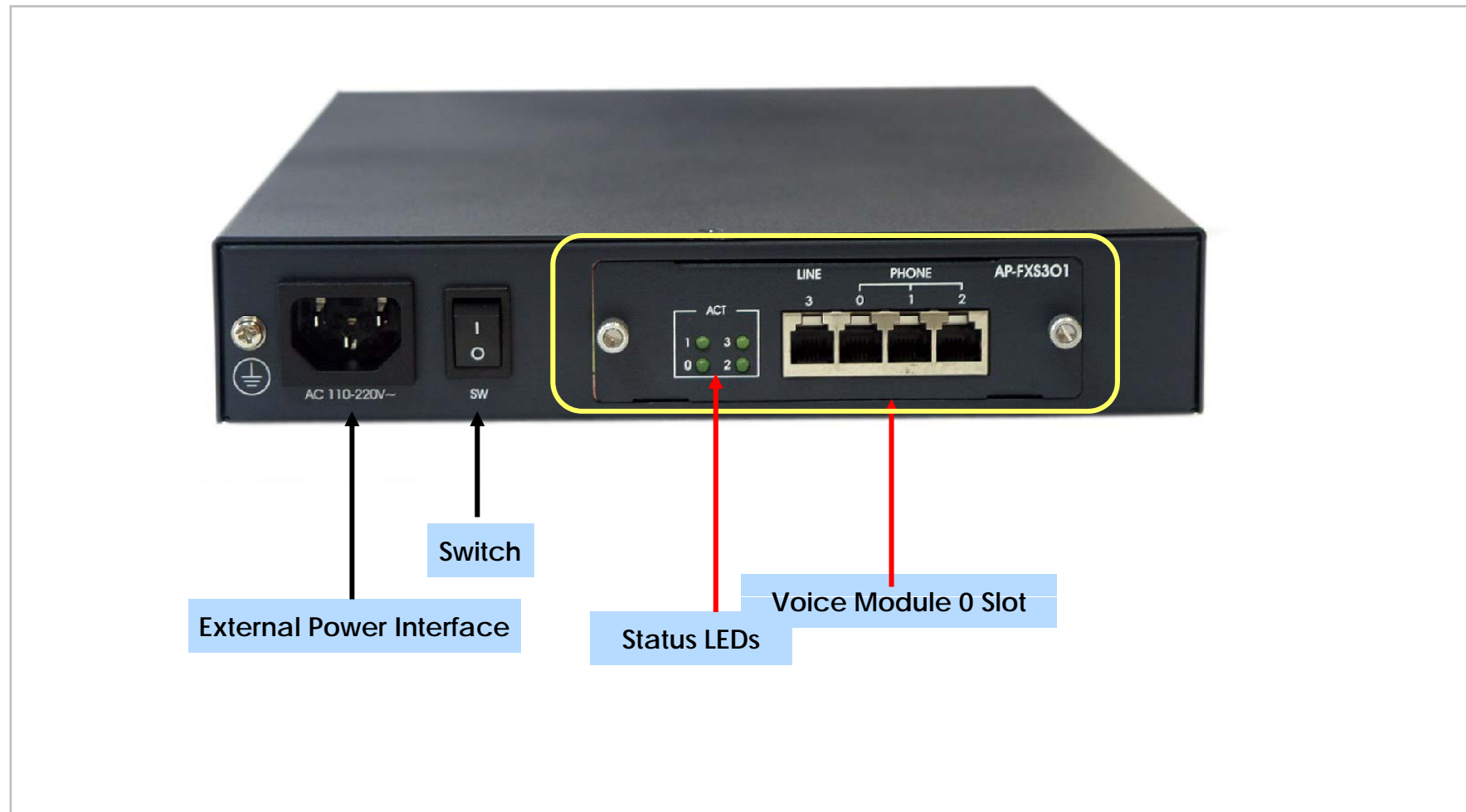

AP2610 VoIP Gateway Product Overview

AP2610 Analog Voice Module

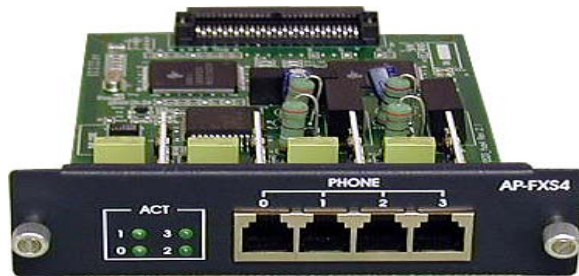

AP-FXS4 Module

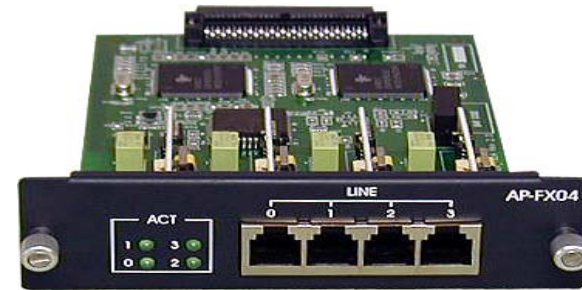

AP-FXO4 Module



AP-FXS2, FXO2 Module



AP-E&M4 Module

AP2610 VoIP Gateway Product Overview

AP2610 Analog Voice Module

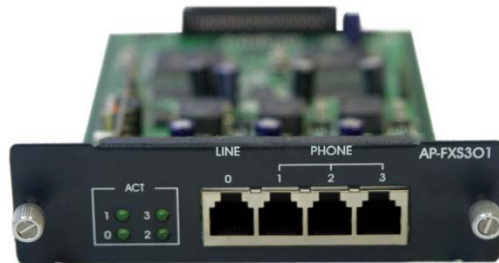

AP-FXS3, FXO1 Module

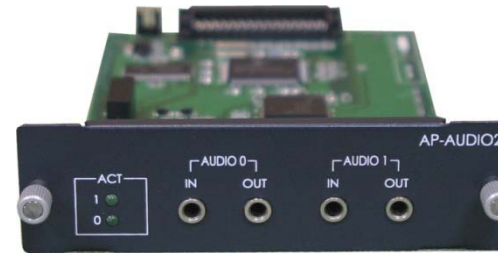

AP-AUDIO2 Module

AP2610 VoIP Gateway Product Overview

AP2610 Hardware Specification

AP2610 VoIP G/W	Basic Specifications
CPU	PowerPC RISC Microprocessor
Voice Interface	4-Ports FXS, FXO, E&M, FXS2O2, FXS3O1, etc Voice Interface
Ethernet Interface	2-Ports 10/100Mbps Ethernet Interface(RJ-45)
Console Port	1-Port RS-232C Console Port(RJ-45)
Flash Memory	4Mbyte High-speed Flash Memory
Base Memory	32Mbyte High-speed SDRAM
Boot Memory	512Kbyte Flash Memory
Power Requirement	VAC110~220V, 50/60Hz, 25Watt
Operating Temperature	0°C ~ 50°C (32 °F ~ 122°F)
Storage Temperature	-40°C ~ 85°C (-40°C ~ 185°F)
Relative Humidity	5% ~ 95% (Non-condensing)
Dimensions	43mm x222mm x 332mm (H x W x D)
Weight (g)	2.2Kg

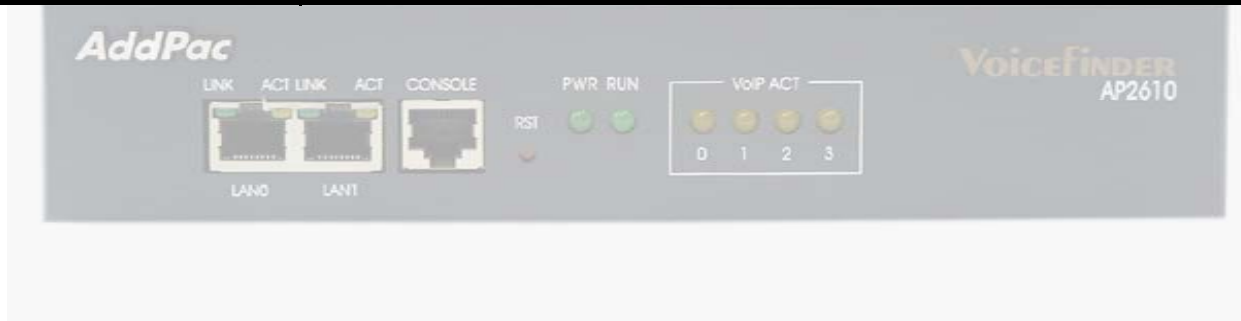

AP2610 Voice Networking Configuration

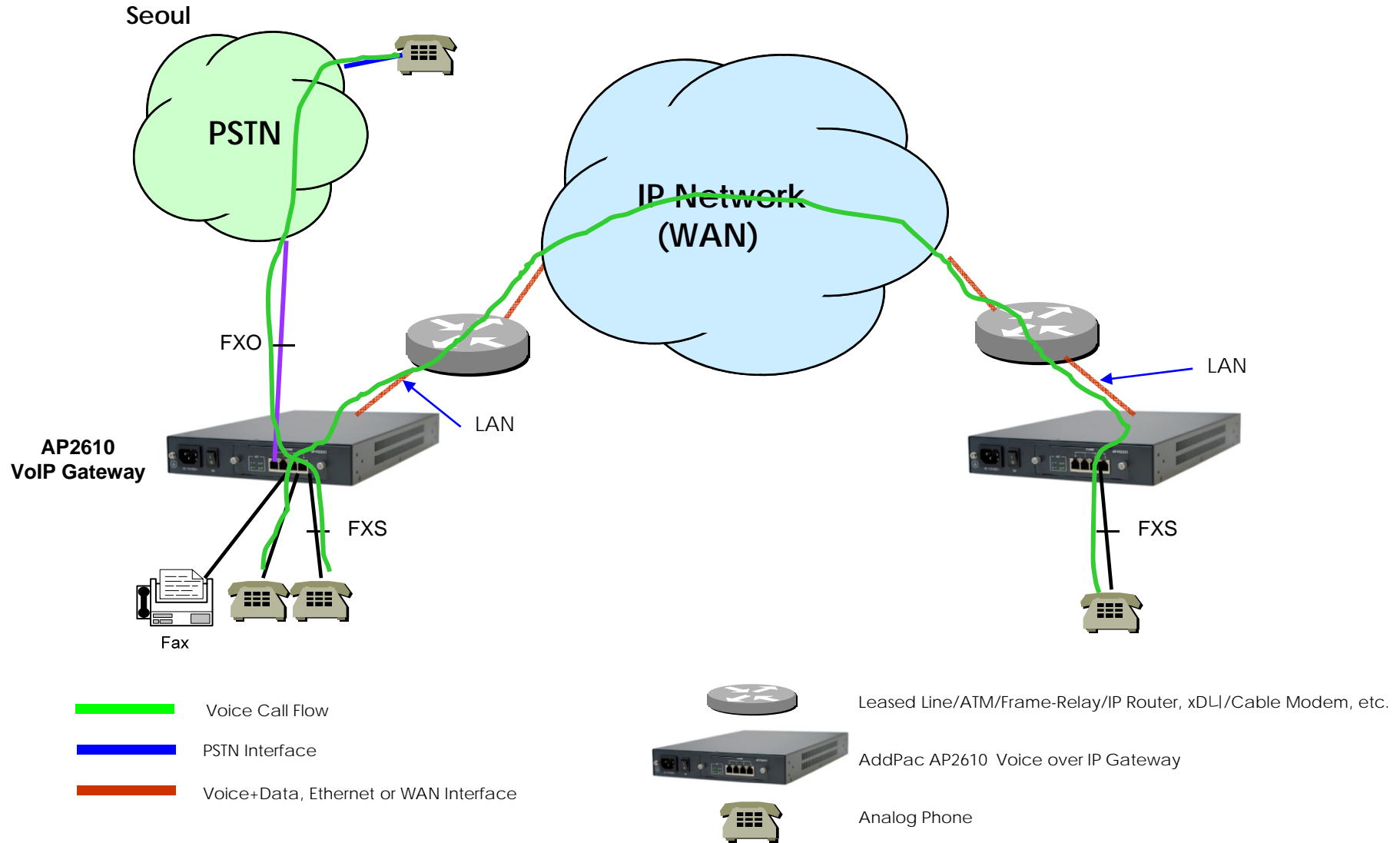

AP2610 Voice Networking Configuration

Inter-office calls

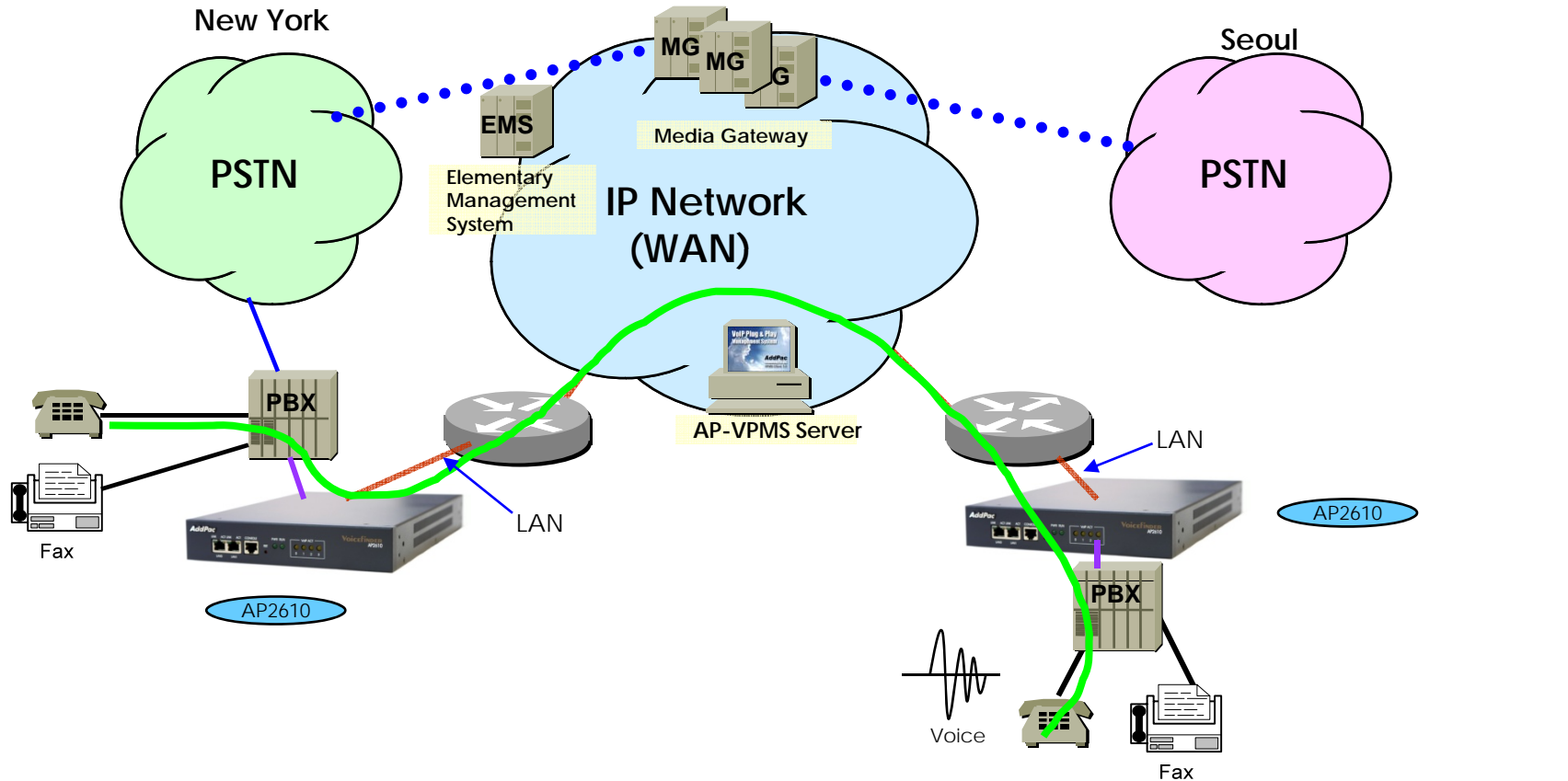

 Voice Call Flow

 PSTN Interface

 Voice+Data, Ethernet or WAN Interface

 TRUNK n x E1 Voice Interface for PSTN Interworking

 Leased Line/ATM/Frame-Relay/IP Router, xDSL/Cable Modem, etc.

 AddPac AP2610 Voice over IP Gateway

 Analog Phone

AP2610 Voice Networking Configuration

VoIP to PSTN Inter-working Call Flow

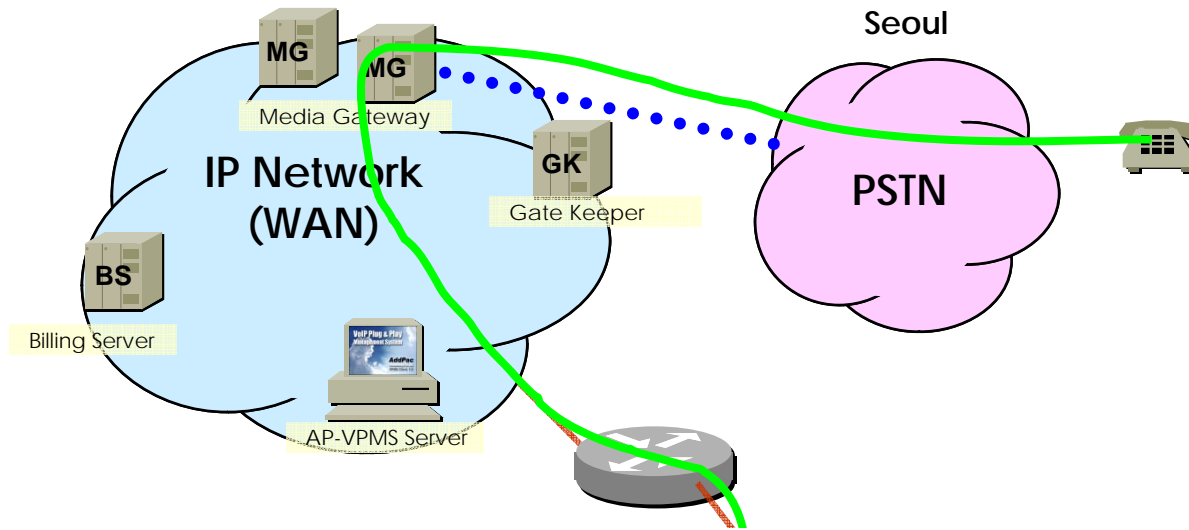

— FXS Analog Voice Interface

— Voice Call Flow

— Voice+Data, Ethernet or WAN Interface

••••• TRUNK n x E1 Voice Interface for PSTN Interworking

Leased Line/ATM/Frame-Relay/IP Router, xDSL/Cable Modem, etc.

AddPac AP2610 Voice over IP Gateway

Analog Phone

AP2610 VoIP Gateway Product Overview

AP2610 Ordering and Pricing

- **AP2610 VoIP Gateway**

- VoIP Gateway Hardware

- Two(2)Fast Ethernet, One(1) Console
 - One(1) Voice Interface Modules
 - 32bit RISC CPU, 4MB Flash, 32MB SDRAM
 - APOS v5.xx with Operation Manual
 - Including CAB-LAN, CAB-CON

- AP-FXS4 4Port FXS Interface Module
 - AP-FXS4H 4Port NGN FXS Interface Module
 - AP-FXO4 4Port FXO Interface Module
 - AP-E&M4 4Port E&M Interface Module
 - AP-E&M2 2Port E&M Interface Module
 - AP-FXS2O2 2Port FXS & 2Port FXO Interface Module
 - AP-FXS3O1 3Port FXS & 1Port FXO Interface Module

- **Pricing**

- AddPac Technology Regional Sales Managers
 - Authorized Sales and Marketing Representatives
 - Please Contact www.addpac.com

AP2610 VoIP Gateway Product Overview

AP2610 Comparison Table

	AP2610 VoIP Gateway
▶ FXS Voice Ports (RJ11)	Up to 4
▶ FXO Voice Port (RJ11)	Up to 4
▶ E&M Voice Module	Up to 4
▶ 10/100 Mbps Ethernet Ports (RJ45)	2
▶ Console Ports (RJ45)	1
▶ CPU	Power PC RISC Microprocessor
▶ Flash Memory	4Mbyte
▶ Base Memory	32Mbyte
▶ Power Requirement	VAC 110~220V, 50/60Hz, 25Watt
▶ Internetworking OS	APOS
▶ H.323, SIP VoIP Protocol, T38 FAX, MGCP	YES
▶ PPPoE, PPTP Network Protocols	YES
▶ Enhanced QoS Management Feature	YES
▶ IP Routing Protocols Including NAT	YES
▶ Network Management Protocols	YES
▶ Support Network Environments	ADSL, VDSL, Cable Modem, Leased Line, ATM, Frame-Relay, Including Conventional Broad Band Networking

AddPac Technology Co., Ltd.

Thank you !

www.addpac.com

Technical Sales and Marketing

Phone : +82 2 568 3848

Fax : +82 2 568 3847

sales@addpac.com